

ROTEL

Owner's Manual

RX-975 AM/FM Stereo Receiver

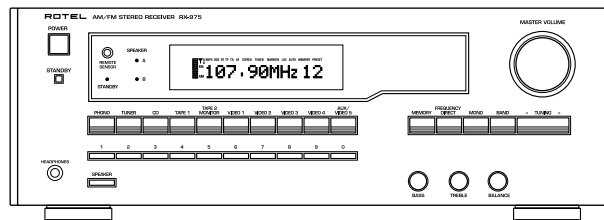



APPLICABLE FOR USA, CANADA OR WHERE APPROVED FOR THE USAGE

CAUTION: TO PREVENT ELECTRIC SHOCK, MATCH WIDE BLADE OF PLUG TO WIDE SLOT. INSERT FULLY.

ATTENTION: POUR EVITER LES CHOCS ELECTRIQUES, INTRODUIRE LA LAME LA PLUS LARGE DE LA FICHE DANS LA BORNE CORRESPONDANTE DE LA PRISE ET POUSSER JUSQU'AU FOND.

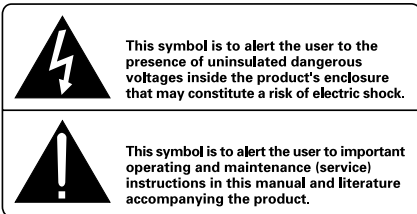

WARNING:

There are no user serviceable parts inside. Refer all servicing to qualified service personnel.

WARNING:

To reduce the risk of fire or electric shock, do not expose the unit to moisture or water. Do not allow foreign objects to get into the enclosure. If the unit is exposed to moisture, or a foreign object gets into the enclosure, immediately disconnect the power cord from the wall. Take the unit to a qualified service person for inspection and necessary repairs.

Read all the instructions before connecting or operating the component. Keep this manual so you can refer to these safety instructions.

Heed all warnings and safety information in these instructions and on the product itself. Follow all operating instructions.

Clean the enclosure only with a dry cloth or a vacuum cleaner.

You must allow 10 cm or 4 inches of unobstructed clearance around the unit. Do not place the unit on a bed, sofa, rug, or similar surface that could block the ventilation slots. If the component is placed in a bookcase or cabinet, there must be ventilation of the cabinet to allow proper cooling.

Keep the component away from radiators, heat registers, stoves, or any other appliance that produces heat.

The unit must be connected to a power supply only of the type and voltage specified on the rear panel of the unit.

ANTENNA GROUNDING ACCORDING TO NATIONAL ELECTRICAL CODE INSTRUCTIONS ARTICLE 810: "RADIO AND TELEVISION EQUIPMENT"

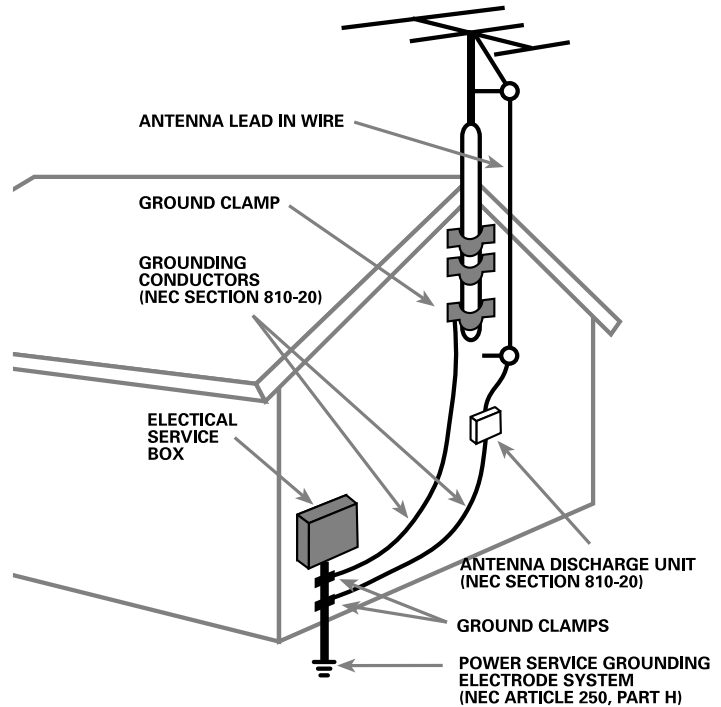

Connect the component to the power outlet only with the supplied power supply cable or an exact equivalent. Do not modify the supplied cable in any way. Do not attempt to defeat grounding and/or polarization provisions. Do not use extension cords.

Do not route the power cord where it will be crushed, pinched, bent at severe angles, exposed to heat, or damaged in any way. Pay particular attention to the power cord at the plug and where it exits the back of the unit.

The power cord should be unplugged from the wall outlet if the unit is to be left unused for a long period of time.

Immediately stop using the component and have it inspected and/or serviced by a qualified service agency if:

- The power supply cord or plug has been damaged.
- Objects have fallen or liquid has been spilled into the unit.
- The unit has been exposed to rain.
- The unit shows signs of improper operation
- The unit has been dropped or damaged in any way

Place the unit on a fixed, level surface strong enough to support its weight. Do not place it on a moveable cart that could tip over.



NOTE TO CATV SYSTEM INSTALLER:

Call the CATV system or antenna installer's attention to Article 820-40 of the NEC. This provides guidelines for proper grounding and, in particular, specifies that the cable ground shall be connected to the grounding system of the building, as close to the pint of cable entry as practical. See installation diagram.

NOTE:

This equipment has been tested and found to comply with the limits for a Class B digital device, pursuant to Part 15 of the FCC Rules. These limits are designed to provide reasonable protection against interference in a residential installation. This equipment generates and can radiate radio frequency energy and, if not installed and used in accordance with the instructions, may cause interference to radio or TV communications. There is no guarantee that interference will not occur in a particular installation. If this equipment does cause interference to radio or television reception, which can be determined by turning the equipment off and on, try to correct the interference by one or more of the following measures:

- Reorient or relocate the receiving antenna.
- Increase the separation between the unit and the television tuner.
- Connect the unit to an AC power outlet on a different electrical circuit.
- Consult your authorized Rotel retailer for assistance.

Figure 1: Controls and Connections

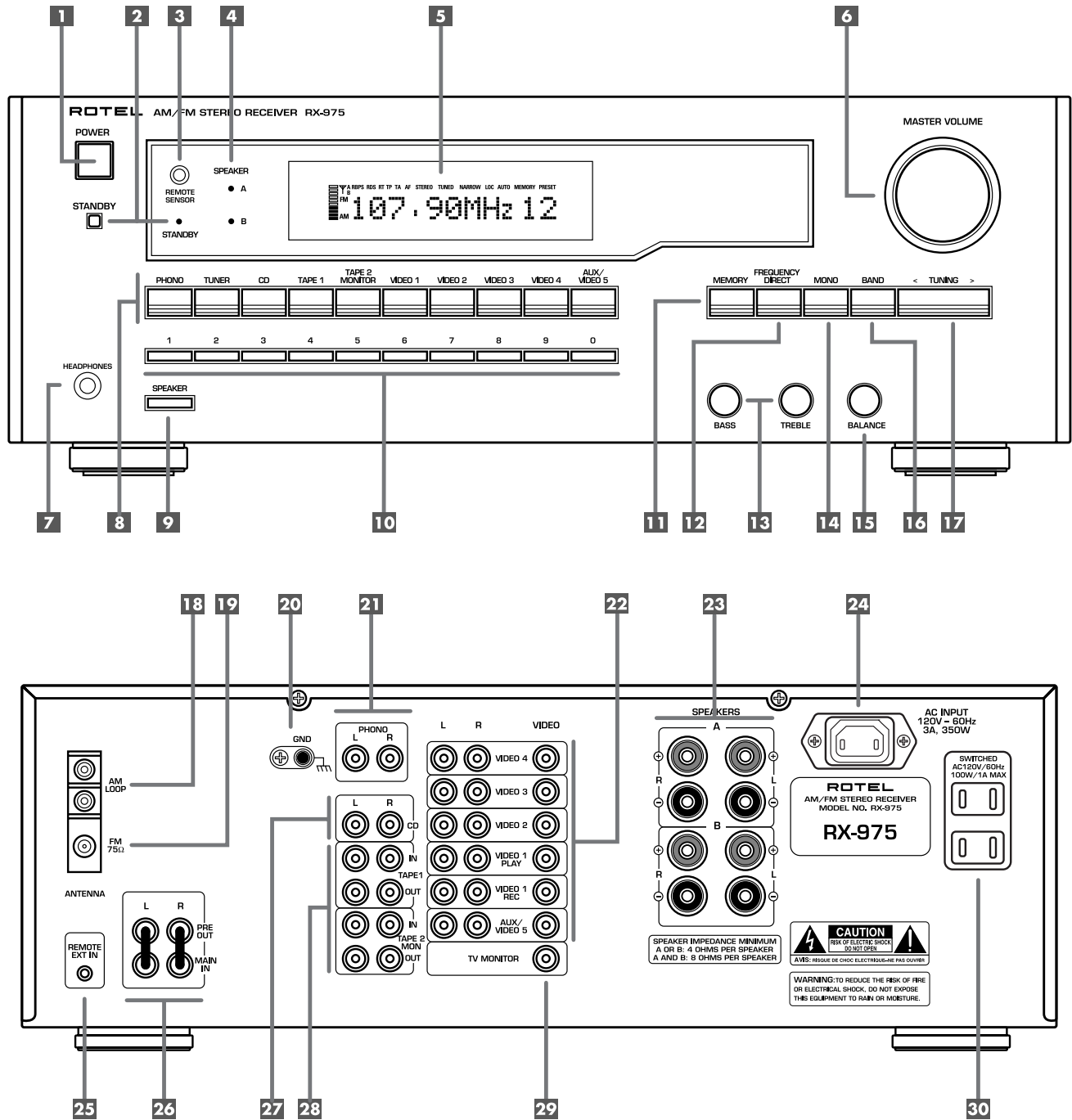

Figure 2: RR-949 Remote Control

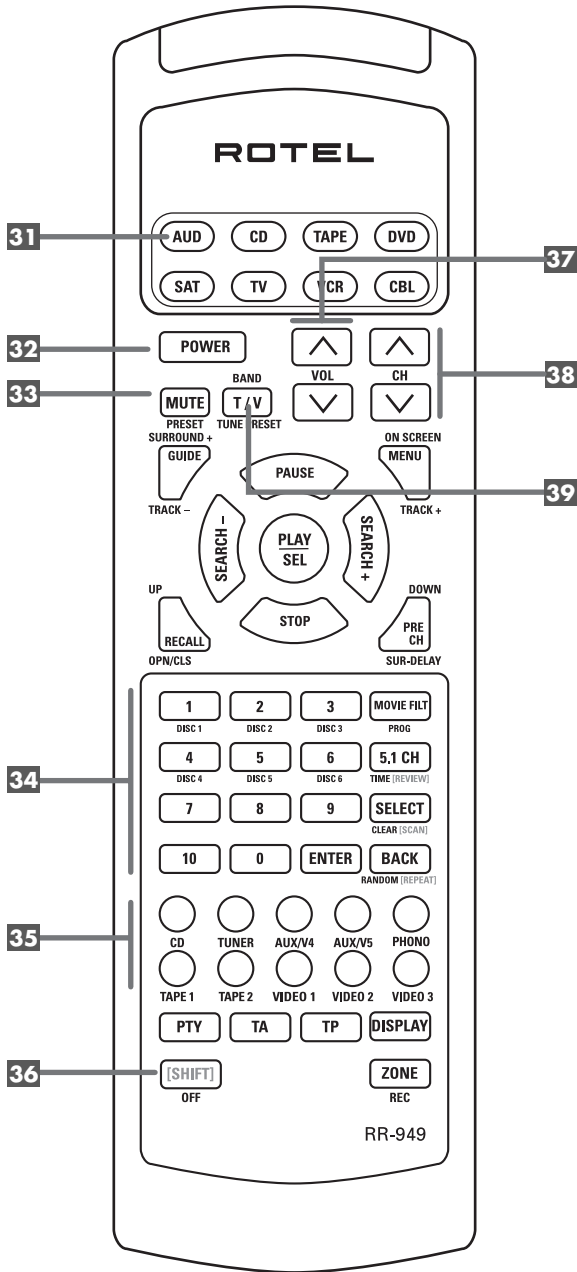

Figure 3: Antenna Connections

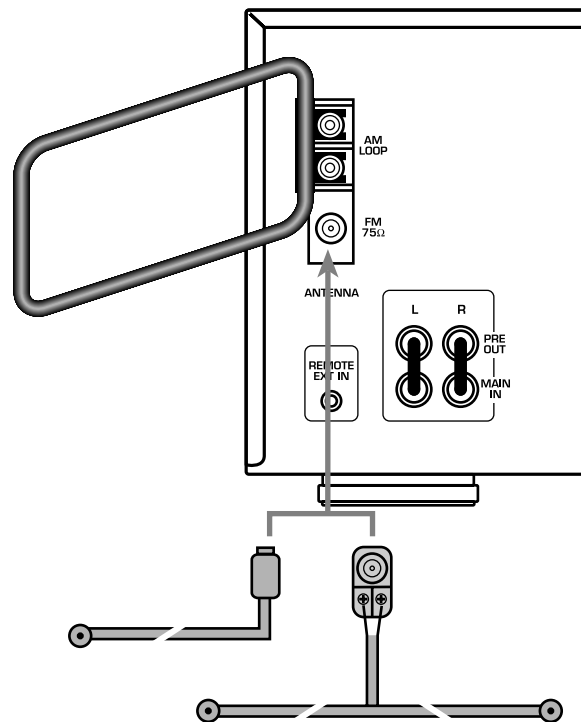

Figure 4: Input Connections

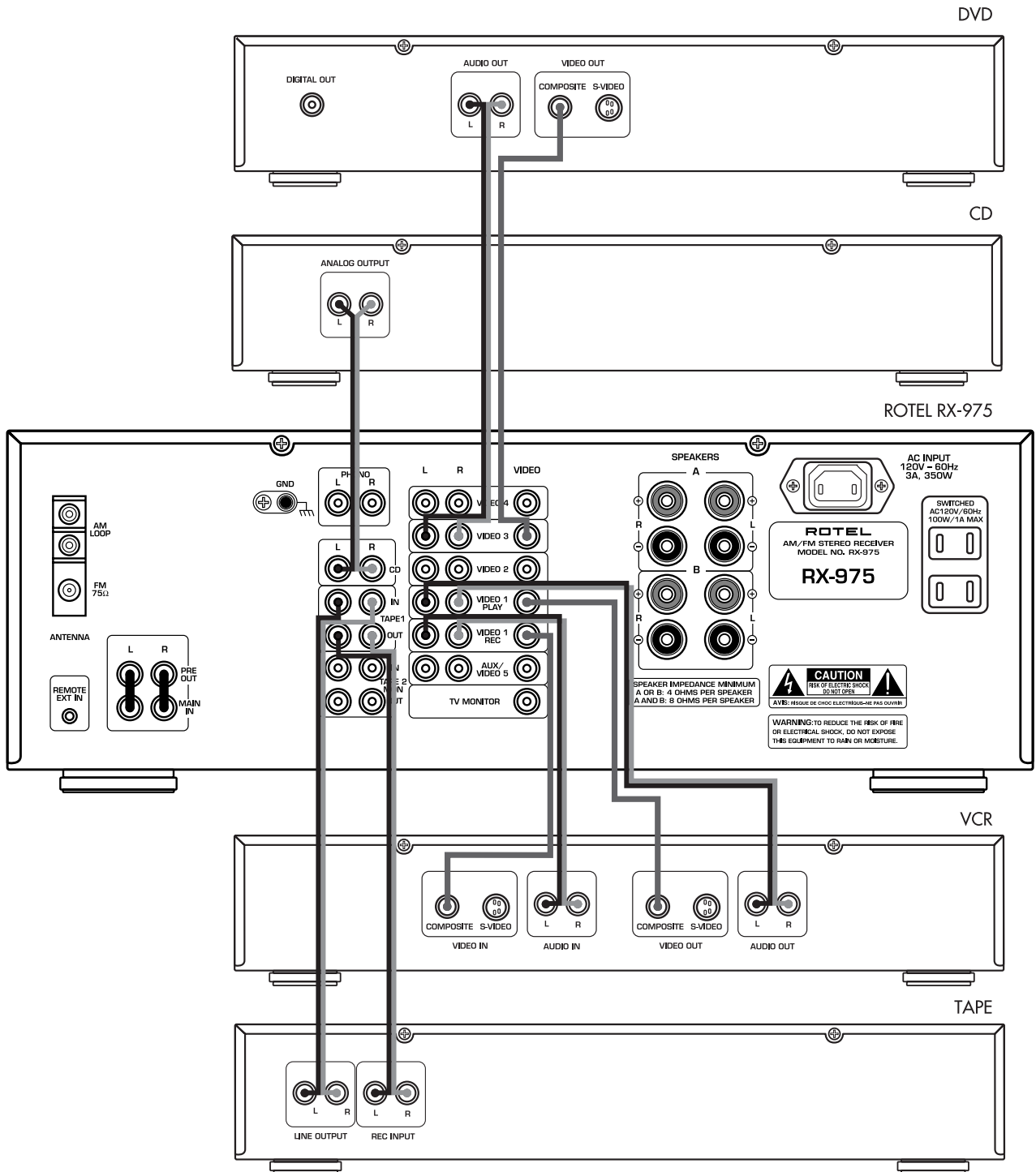
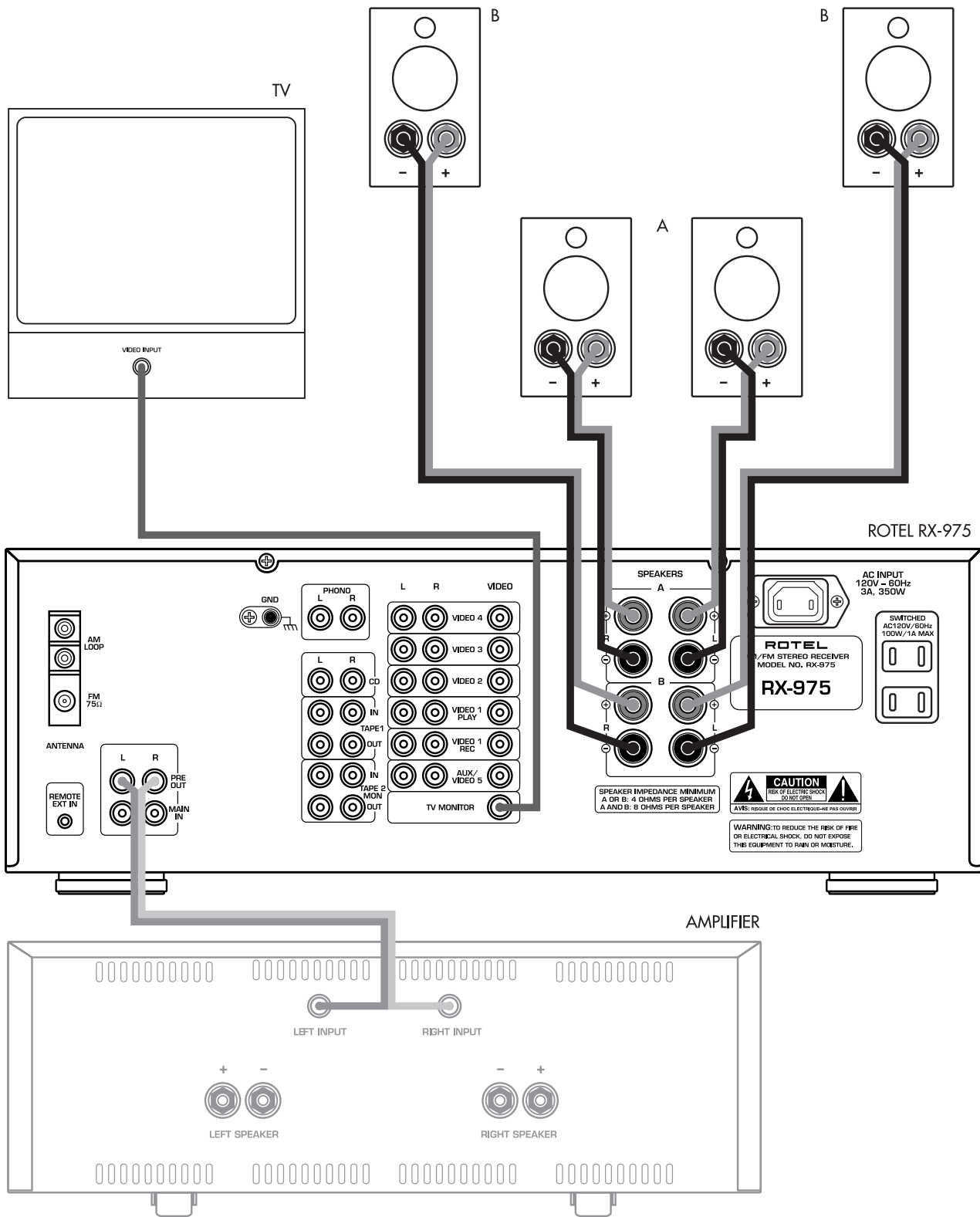

Figure 5: Output Connections



Contents

Figure 1: Controls and Connections	3	PRESET AUTO SCAN Button	
Figure 2: RR-949 Remote Control	4	[SHIFT] MUTE 33 36	11
Figure 3: Antenna Connections	4	TV/BAND Button 39	11
Figure 4: Input Connections	5	TUNE/PRESET Button	
Figure 5: Output Connections	6	[SHIFT] TV/BAND 36 39	11
About Rotel	8	CH TUNING Buttons 38	11
Getting Started	8	INPUT SOURCE Buttons 35	12
Unpacking	8	NUMERIC Buttons 34	12
Placement	8	Rear Panel Connections	12
Main Operating Controls	8	Phono Inputs 21 and Phono Ground 20	12
Power Switch 1 and Standby Switch 2 32	8	CD Inputs 27	12
Remote Sensor 3	9	Tape Inputs and Outputs 28	12
Front Panel Display 5	9	VIDEO 1 Inputs/Outputs 22	12
Master Volume 6 37	9	VIDEO 2 – 5 Inputs 22	12
Tone Controls 13	9	TV Monitor Output 29	12
Balance Control 15	9	Speaker Outputs 23	12
Headphones Jack 7	9	Preamp Inputs/Outputs 26	13
Speaker Button 9 and Speaker LEDs 4	9	Antenna Connections	13
MEMORY Button 11	9	AM Loop Antenna 18	13
Input Source Buttons 8 35	9	FM Wire Antenna 19	13
Tuning Controls	10	AC Power Connections	14
BAND Button 16 39	10	AC Input 24	14
TUNING Button 17 38	10	AC Convenience Outlet 30	
NUMERIC Buttons: Station Presets 10 34	10	[USA version only]	14
FREQUENCY DIRECT Button 12	10	Remote External Sensor 25	14
MONO Button 14	10	Specifications	15
RR-949 Remote Control	11	Audio	15
AUDIO Button 31	11	Video	15
Programming the RR-949	11	FM Tuner	15
POWER Button 32	11	AM Tuner	15
VOLUME Buttons 37	11	General	15
SHIFT Button 36	11		
MUTE Button 33	11		

About Rotel

A family whose passionate interest in music led them to manufacture high fidelity components of uncompromising quality founded Rotel over 30 years ago. Through the years that passion has remained undiminished and the family goal of providing exceptional value for audiophiles and music lovers regardless of their budget, is shared by all Rotel employees.

The engineers work as a close team, listening to, and fine tuning each new product until it reaches their exacting musical standards. They are free to choose components from around the world in order to make that product the best they can. You are likely to find capacitors from the United Kingdom and Germany, semi conductors from Japan or the United States, while toroidal power transformers are manufactured in Rotel's own factory.

Rotel's reputation for excellence has been earned through hundreds of good reviews and awards from the most respected reviewers in the industry, who listen to music every day. Their comments keep the company true to its goal - the pursuit of equipment that is musical, reliable and affordable.

All of us at Rotel, thank you for buying this product and hope it will bring you many hours of enjoyment.

Getting Started

Thank you for purchasing the Rotel RX-975 AM/FM Stereo Receiver. The RX-975 is three products in one:

1. A full-featured audio/video control center for analog audio and video source components
2. A high-quality AM/FM tuner with 30 station presets, direct access tuning, and auto-tuning.
3. A high power 2-channel amplifier.

Rotel's Balanced Design Concept combines advanced circuit board layout, comprehensive parts evaluation, and extensive listening tests for superior sound and long term reliability. We are confident that you will enjoy the high performance of your Rotel RX-975 for years to come.

In addition, the RX-975 includes a universal remote control that is factory programmed operate the RX-975 and can be programmed to operate up to seven other components of your choice, providing the convenience of whole-system control from a single remote.

Unpacking

Remove the unit carefully from its packing. Look for the handheld remote control and other accessories. Save the packing and box as it will protect the RX-975 if you move or need to return it for maintenance.

Placement

Place the RX-975 on a solid, dry, level surface away from direct sunlight, excessive heat, high humidity, or strong vibrations.

The RX-975 can generate considerable heat during normal operation. Do not block its ventilation openings. Allow a minimum of 10 cm (4 inches) of unobstructed open space around the unit. If installed in a cabinet, make sure that there is adequate ventilation.

Make sure the RX-975 is close to the other components in your audio/video system and, if possible, place it on its own shelf. This will make initial cable routing, hookup, and any subsequent system changes easier. It also minimizes potential interference or heat buildup from other components.

Make sure there is enough room behind the RX-975 for easy hookup. Remember, you are connecting many other components to this unit and you'll probably need more space than you think.

Don't stack other objects (components or other items) on top of the RX-975. Don't let water fall into the RX-975 as this could damage delicate circuitry.

Main Operating Controls

We suggest you look over the RX-975's front and rear panels before you start connecting other components to it. The following explanations will help you get familiar with the units connections, features, and controls, with number references corresponding to the illustrations at the front of this manual.

Most functions are duplicated on the front panel and on the remote control shipped with your unit. A few may be available only on one or the other. When two reference numbers appear, one refers to the location of the button on the front panel, the other to the location of the button on the handheld remote control.

NOTE: *Front panel controls and displays used for tuning the AM/FM receiver are described in the next section of this manual.*

POWER Switch **1** and STANDBY Switch **2** **32**

The RX-975 has two pushbuttons for powering on and off. The POWER switch completely shuts down all of the circuitry, similar in effect to removing the power cord from the AC outlet. The STANDBY switch deactivates the unit, but preserves power to some circuits such as those that store memorized circuits. When in STANDBY mode, a front panel STANDBY LED indicator lights. The STANDBY switch is duplicated on the RX-975's remote.

In normal operation, use the STANDBY switch to deactivate the unit when you are finished listening and leave the POWER switch ON at all times. This will preserve memory functions.

NOTE: The STANDBY switch also controls the rear panel AC outlets. When the RX-975 is in STANDBY mode, the AC outlet is also off. When the RX-975 is fully functional, the AC outlet is live.

Remote Sensor **3**

This sensor receives infrared signals from the handheld remote control. Make sure you do not accidentally block this sensor with cables or accessories.

Front Panel Display **5**

The large fluorescent display in the upper portion of the RX-975 provides status information used in operating the AM/FM receiver (such as station frequency display, band, preset memory, etc.).

MASTER VOLUME **6 37**

The MASTER VOLUME control adjusts the level of all output channels simultaneously. Rotate the control clockwise to increase the volume. Rotate counterclockwise to decrease the volume. MASTER VOLUME buttons are also available on the RX-975's handheld remote control.

When you adjust the volume, a bar indicator in the display shows the volume setting.

TONE Controls **13**

BASS and TREBLE controls increase and decrease the audio signal's low and high frequency content respectively. Rotate clockwise to increase output in the respective frequency range and counterclockwise to reduce it. The center detent removes each control from the audio path for maximum signal integrity.

BALANCE Control **15**

Turn the BALANCE control clockwise to increase the output level of the right channel speakers. Turn counterclockwise to increase the output level of the left channel speakers. The center detent position removes the control from the circuit and provides equal output from both left and right channels.

HEADPHONES Jack **7**

This jack accepts a standard 1/4 inch stereo headphone plug. Use an adaptor if your headphones have the smaller mini-plug. Inserting a headphone plug will automatically disable all speaker outputs.

SPEAKER Button **9** and SPEAKER LEDs **4**

The RX-975 provides output connections for two pairs of speakers: A and B. The SPEAKER BUTTON controls which pairs of speakers outputs, if any, are active. A pair of SPEAKER LED indicators located to the left of the DISPLAY shows the current speaker selection. Press the SPEAKER button repeatedly to step sequentially through the four available speaker options:

- Speakers A active (LED A only lit)
- Speakers B active (LED B only lit)
- Speakers A and B active (both LEDs lit)
- All speakers off (no LEDs lit)

NOTE: Inserting a headphone plug into the headphone jack disables all speaker outputs, regardless of the SPEAKER button setting.

MEMORY Button **11**

The MEMORY button is used to confirm and memorize tuner station presets. Its use is described in detail in the Tuning Controls section of this manual.

Input Source Buttons **8 35**

Ten large front panel buttons directly select an audio or video input source (such as a CD player, the built-in tuner, a tape recorder, video sources, etc.) for listening. Push any of these buttons (or the duplicates on the handheld remote) to select the desired source. You will hear this source and, if you have selected a video source, see its picture on your TV monitor. The front panel display will show the current source selection.

TAPE MONITOR Buttons: Two of the INPUT SOURCE buttons have a special function. The TAPE 1 and TAPE 2 MONITOR buttons activate the audio inputs of a tape monitor loop consisting of a pair of outputs and a matching set of inputs. Normally, this tape monitor loop is used to play a tape deck connected to these inputs or for real time monitoring of a recording in progress on an audio tape deck. Alternatively, the tape monitor loop could be used to pass a signal to a graphic equalizer and listen to the processed signal by pressing the corresponding TAPE MONITOR button. An indicator appears in the front panel display when TAPE 2 MONITOR is activated.

Tuning Controls

The RX-975 features a digital synthesized AM/FM tuner with 30 station presets. Operation of the tuning functions involves the use of a row of numeric buttons and five large buttons below the MASTER VOLUME knob.

BAND Button 16 39

The BAND button selects whether the tuner is in AM or FM mode. Press the button to toggle back and forth between AM and FM. A corresponding indicator will light at the left portion of the front panel display to confirm your choice and the currently tuned station frequency will be shown.

TUNING Button 17 38

This rocker switch (or pair of buttons labeled CH UP/DOWN on the remote control) provides two different tuning functions, depending on the mode of operation.

In the normal FREQUENCY TUNING mode, press a TUNING button and release to manually jump to the next station frequency, regardless of whether or not a station is broadcasting on that frequency. For auto scan tuning, press and hold the TUNING button for approximately one second. An AUTO indicator will appear in the front panel display and the tuner will begin automatically scanning up or down through the frequencies until the next available station is detected. If this is not the desired station, repeat the automatic tuning procedure to find the next station. Weak stations will be skipped during auto tuning.

In the PRESET TUNING mode, press a TUNING button and release to jump to the next memorized station preset. Switch between FREQUENCY and PRESET tuning modes by pressing the SHIFT button and then the BAND/TV button on the remote control. A PRESET indicator appears in the display when PRESET TUNING is activated.

NOTE: Several indicators in the front panel display assist tuning. A large display shows the tuned frequency and increases or decreases during tuning. A TUNED indicator lights when a sufficiently strong signal is received. A ST indicator lights when a stereo FM signal is received.

NUMERIC Buttons: Station Presets 10 34

The RX-975 can store up to 30 station presets for recall at any time using the NUMERIC buttons. To memorize a station:

1. Tune to the desired station, AM or FM.
2. Press the MEMORY button on the front panel. A MEMORY indicator will flash for five seconds in the front panel display.
3. While the MEMORY indicator is flashing, press the number of the preset where you wish to store the station frequency. For example, to memorize the station as preset 3, press the 3 button. To memorize preset 15, press the 1 button followed by the 5 button.
4. A previously stored frequency is erased from memory when a new frequency is memorized for the same preset number.

To tune to a previously memorized station, just press the preset number on the NUMERIC buttons. For example, to tune to preset 3, press the 3 button. To tune to preset 15, press the 1 button and then press the 5 button.

NOTE: If the TUNER is not already the selected INPUT SOURCE, selecting a station preset will automatically switch to the TUNER input and tune the memorized station.

The NUMERIC buttons can also be used for direct access tuning (see below).

FREQUENCY DIRECT Button 12

If you know the frequency of the desired station, you may tune it directly using the FREQUENCY DIRECT button and the NUMERIC buttons.

1. Press the FREQUENCY DIRECT button to change the NUMERIC buttons from station preset to Direct Access mode. The station frequency in the front panel display will change to a series of four bars, representing the digits of a station frequency, with the first bar flashing.

2. Enter the first digit of the station frequency using the NUMERIC buttons. The digit will appear in the frequency display and the second bar will flash. Enter the remaining digits of the frequency. When all of the digits have been entered, the tuner will automatically tune to the displayed station frequency.

NOTE: On the USA version only, pressing 1 in the FM mode will enter 10 as the digit in the frequency display. On the European version, it is necessary to press 1 and then 0 to enter 10. For US FM stations, press only one digit following the decimal point as shown in the first example below. For European FM stations, press two digits following the decimal point as shown in the second example.

EXAMPLES:

(USA FM) 87.50MHz	Press 8>7>5
(Europe FM) 87.50MHz	Press 8>7>5>0
(all AM) 1610kHz	Press 1>6>1>0

MONO Button 14

The MONO button changes the FM mode from stereo reception to mono reception. In stereo mode, a stereo signal will be heard if the station is broadcasting a stereo signal and there is sufficient signal strength. A stereo indicator will light in the front panel display. In mono mode, a mono signal will be heard even if the station is broadcasting a stereo signal.

NOTE: Switching to mono mode can be a useful way to improve the reception of weak or distant FM signals. Less signal strength is required for clean mono reception than for stereo reception.

RR-949 Remote Control

The RX-975 includes a handheld remote control that does far more than operate the RX-975. The RR-949 is a full-function programmable remote control that can operate up to 8 audio/video components.

A separate manual, included with the remote, gives detailed information on programming and using the RR-949 to replace all of the remote controls in your system. This section is intended to provide only that information which pertains to the use of the RR-949 to operate the RX-975.

NOTE: Many functions duplicate the RX-975 front panel controls and are listed here only for your reference. Please refer to the previous Front Panel Controls section of this manual if you need additional information.

AUDIO Button 31

To operate the RX-975 with the remote, make sure that the AUDIO mode is active by pressing the AUD button on the remote before you start. If it is active, pressing command keys on the RR-949 will cause the AUDIO button to flash red. Once the AUDIO mode is active, it will stay active unless you press one of the other DEVICE buttons to control a different component.

Programming the RR-949

The RR-949 is preprogrammed from the factory to operate the RX-975. Should the AUDIO command set on your RR-949 not operate the RX-975, it's possible that the programming has been inadvertently changed. **To program the remote to operate the RX-975, set the AUDIO Code = 001:**

1. Press the AUDIO button at the top of the remote while simultaneously pressing the MUTE button and hold both for at least one second. The AUDIO button will light in red for 20 seconds, indicating that you have entered the program mode. The next step must be done within this 20 second period, or the RR-949 will revert to its standard operating mode.

2. Use the NUMERIC buttons to enter the 3-digit code (001) for the RX-975 – press 0, then 0, then 1. The AUDIO button will flash each time you enter a digit.
3. Store the code number by pressing the corresponding AUDIO button again. The button will blink twice to confirm the storage of the code in memory.

POWER Button 32

Duplicates the function of the STANDBY switch on the front panel. Press to activate the RX-975. Press again to deactivate. The main POWER button on the front panel must be in the ON position for the remote standby function to operate.

VOLUME Buttons 37

A pair of buttons which duplicate the function of the front panel volume control. Press VOLUME UP to increase the volume and press VOLUME DOWN to decrease the volume.

SHIFT Button 36

Used to access secondary functions on several RR-949 buttons. Press the SHIFT button and then the desired button.

MUTE Button 33

Push this button once to turn the sound off. A mute indication will appear in the front panel display. Press the MUTE button again to restore previous volume levels.

PRESET AUTO SCAN Button

[SHIFT] MUTE 33 36

This shift function activates a PRESET SCANNING feature. Press the SHIFT button and then the MUTE button to scan through all memorized station presets, playing each for five seconds before moving to the next. To stop the station scanning on the desired station preset, press the MUTE button again.

TV/BAND Button 39

Duplicates the AM/FM button on the front panel. Toggles between AM and FM modes.

TUNE/PRESET Button

[SHIFT] TV/BAND 36 39

The TUNE/PRESET button toggles between FREQUENCY TUNING mode (the CH TUNING buttons advance to the next station frequency) and PRESET TUNING mode (the CH TUNING Buttons advance to the next memorized station preset). To change modes, press the SHIFT button and then the TV/BAND button. A PRESET indicator in the front panel DISPLAY will light when the PRESET mode is active.

CH TUNING Buttons 38

A pair of buttons, labeled CH UP/DOWN, which duplicates the functions of the front panel TUNING button.

In the normal FREQUENCY TUNING mode,

press a CH button and release to manually jump to the next station frequency, regardless of whether or not a station is broadcasting on that frequency. For auto scan tuning, press and hold the CH button for approximately one second. An AUTO indicator will appear in the front panel display and the tuner will begin automatically scanning up or down through the frequencies until the next available station is detected. If this is not the desired station, repeat the automatic tuning procedure to find the next station. Weak stations will be skipped during auto tuning.

In the PRESET TUNING mode,

press a CH button and release to jump to the next memorized station preset. Switch between FREQUENCY and PRESET tuning modes by pressing the SHIFT button and then the BAND/TV button on the remote control. A PRESET indicator appears in the display when PRESET TUNING is activated.

INPUT SOURCE Buttons **35**

Two rows of buttons duplicate the function of the ten INPUT SOURCE buttons on the front panel. Select an input source by pressing the appropriate button. The AUX 1 and AUX 2 buttons correspond to the front panel VIDEO 4 and VIDEO 5 buttons.

NUMERIC Buttons **34**

Ten numeric buttons, labeled 0 through 9, duplicate the function of the NUMERIC buttons on the front panel. Selects memorized station presets.

Rear Panel Connections

The RX-975 provides rear panel connections for five video sources, three audio sources, and a phono input for use with a turntable. These connections include standard RCA audio inputs and outputs plus composite video inputs and outputs.

The RX-975 includes two pairs of speaker connections for the built-in power amplifier as well as RCA preamp outputs for use with external amplifiers. In addition, a composite video output connects the unit to your TV monitor.

NOTE: DO NOT plug any system component into an AC source until system hookup is complete and you are confident that all component-to-component connections have been properly made.

All video cables should have a 75 ohm impedance rating. Although conventional audio interconnects will pass a video signal, their construction and limited bandwidth impose a performance penalty because, in part, they do not adhere to the 75 ohm standard.

When making signal connections, make sure that you always preserve proper channel consistency, i.e. connect LEFT channels to LEFT channel jacks and RIGHT channels to RIGHT channel jacks. All RCA-type connections on the RX-975 follow these standard color codes:

Left audio: RCA jack with white inset
 Right audio: RCA jack with red inset
 Video: RCA jack with yellow inset

Connect your audio-only source components to these RCA inputs and outputs:

Phono Inputs **21** and Phono Ground **20**

Connect the left and right output cables of a turntable to this pair of RCA inputs. Connect the ground wire from your turntable to the phono ground lug, labeled GND.

CD Inputs **27**

Connect the left and right analog outputs from a CD player to the RCA input jacks labeled CD.

Tape Inputs and Outputs **28**

The RX-975 provides two sets of audio tape connections labeled TAPE 1 and TAPE 2. Each has a pair of inputs and a pair of record outputs that allow recording on either tape deck.

Connect the left and right analog outputs from an audio tape deck to the TAPE 1 IN input jacks. Connect the TAPE 1 OUT output jacks to the INPUTS on the audio tape deck.

Connect a second tape deck to the TAPE 2 connections – the outputs of the tape deck to the IN jacks on the RX-975 and the OUT jacks on the RX-975 to the inputs on the tape deck.

VIDEO 1 Inputs/Outputs **22**

There are groups of connections for up to five video source components. Each group includes a pair of RCA analog audio inputs and a composite video input. One group, VIDEO 1, also includes a set of record outputs for sending audio and video signals to a VCR.

Connect your VCR to the VIDEO 1 group of inputs and outputs. This set of connections allows recording.

Connect the analog audio **outputs** of the VCR to the VIDEO 1 PLAY left and right RCA audio jacks. Connect the VIDEO 1 REC left and right RCA audio output jacks to the audio **inputs** on the VCR.

Connect the RCA composite video **output** of the VCR to the RCA composite video **input** labeled VIDEO 1 PLAY.

Hookup the VIDEO 1 REC video output to the RCA composite video recording input on your VCR.

VIDEO 2 – 5 Inputs **22**

These four sets of audio/video inputs allow connection of four additional video components such as a play-only VCR, DVD player, LaserDisc player, or DSS satellite receiver.

Connect the RCA analog audio outputs of the first video component to the left and right RCA analog audio inputs labeled VIDEO 2. Then, connect the RCA composite video output of the video source to the corresponding RCA composite connection labeled VIDEO 2.

Repeat for additional components, using VIDEO 3, VIDEO 4, and AUX/VIDEO 5.

NOTE: Any of the video source inputs may also be used for an audio-only source. Simply omit the video connection.

TV Monitor Output **29**

The video output of the RX-975 sends the video signal to your TV monitor. Connect the TV MONITOR output to an RCA composite video input on your television monitor. Whatever input source is selected on the RX-975 will appear on screen.

Speaker Outputs **23**

The RX-975 has a built-in stereo amplifier for driving left and right speakers. There are two pairs of connections on the back panel which allow you to connect two pairs of speakers (A and B) and select them with a front-panel button.

NOTE: The combined speaker impedance must be a minimum of 4 ohms. If you are driving just one pair of speakers (A or B connections), use speakers with a nominal impedance of 4 ohms or higher. If you are driving two pairs of speakers (A and B) simultaneously, use speakers rated at 8 ohms or higher.

The back panel speaker connections consist of two groups of binding posts which accept bare wire or banana type plug connectors (except in the European Community countries where their use is not permitted). One group is used for the A speakers; the other for the B speakers. Each group has a positive (+) and negative (-) connection for the right speaker and a positive (+) and negative (-) connection for the left speaker

Each pair of connectors is color-coded for polarity: red for the positive connection and black for the negative connection. All speakers and all speaker wire is also marked for polarity. It is essential for proper performance to maintain this polarity at all speaker connections. Always connect the positive terminal of each speaker to the corresponding red speaker terminal on the RX-975 and the negative speaker terminal to the corresponding black connector on the RX-975.

Route the wires from the RX-975 to the speakers. Give yourself enough slack so you can move the components to allow access to the speaker connectors. If you are using banana plugs, connect them to the wires and then plug into the backs of the binding posts. The collars of the binding posts should be screwed in all the way (clockwise). If you are attaching bare wires directly to the binding posts, separate the wire conductors and strip back the insulation from the end of each conductor. Be careful not to cut into the wire strands. Unscrew the binding post collars. Insert the wire into the hole in the shaft. Turn the collars clockwise to clamp the wire in place.

NOTE: Be sure there are no loose wire strands that could touch adjacent wires or connectors.

Preamp Inputs/Outputs 26

The RX-975 provides a pair of variable-level RCA preamp audio outputs and a pair of RCA amplifier inputs that allow you to use external amplifiers in place of, or in addition to, the built-in amplifiers.

NOTE: The preamp outputs are connected to power amplifier inputs with metal jumpers in a standard PRE OUT/MAIN IN configuration. To disable the built-in power amplifiers and use external amplifiers, it will be necessary to remove these jumpers. Save them for future use.

To hook up the RCA audio outputs to an external amplifier, connect a standard audio cable from each output to the input of the amplifier channel that will power the corresponding speaker.

Antenna Connections

The RX-975 requires two antennas to receive radio signals, one for AM and one for FM. Most users will get acceptable reception using the indoor antennas which are supplied with the RX-975. Instructions for hooking up these antennas follow.

NOTE: If you are located a long distance from the radio transmitters, you may use an outdoor antenna to improve reception. Outdoor antenna systems can be dangerous if they are not properly grounded and should be installed by a professional contractor familiar with the electrical code requirements in your local area.

AM Loop Antenna 18

The RX-975 includes a loop antenna to receive AM radio signals. Remove this antenna from the box and locate it near the RX-975.

Connect the 300 ohm twin-conductor wire from the loop antenna to the pair of screw terminals labeled AM LOOP, attaching one wire to each terminal. It does not matter which wire attaches to which terminal, but make sure that the connections are solid and that the two wires do not touch.

You may need to rotate or otherwise reorient the antenna to find the best position.

NOTE: To use an outdoor antenna, connect its 300 ohm twin-conductor wire to the AM terminals in place of the loop antenna, only after a professional contractor has installed the antenna system in accordance with local electrical codes.

FM Wire Antenna 19

The RX-975 includes a wire antenna to receive FM signals. In many countries (including the USA), this antenna is a T-shaped twin-conductor 300 ohm antenna. Remove this antenna from the box and connect its two conductors to the two screw terminals on the supplied 300 ohm to 75 ohm adaptor. Connect the coax plug on the converter to the FM 75 ohm antenna connector on the RX-975.

For best reception, unfold the T-shaped wire antenna. There are eyelets at both ends of the T, which allow tacking the antenna to a wall, if desired. Experiment with positioning for best reception.

In some countries, the RX-975 may be supplied with a single wire FM antenna terminated by a 75 ohm coax connector. If your unit is supplied with this antenna, connect it directly to the FM 75 ohm antenna connector.

NOTE: To use an outdoor antenna, connect its 75 ohm coax lead wire (or 300 ohm twin-conductor wire and 300 ohm to 75 ohm adaptor) to the FM 75 ohm connector in place of the indoor wire antenna, only after a professional contractor has installed the antenna system in accordance with local electrical codes.

AC Power Connections

AC Input **24**

Your RX-975 is configured at the factory for the proper AC line voltage in the country where you purchased it (120 volts AC, 60Hz in the US or 230 volts AC, 50Hz in the European community). The AC line configuration is noted on a decal on the back of your unit.

Plug the supplied cord into the AC INPUT receptacle on the back of the unit.

AC Convenience Outlet **30** [USA version only]

Two AC outlets let you plug a power cord from a source component or other accessory into the back of the RX-975 so that it will be turned on and off automatically. The outlet is powered whenever the RX-975 is fully active and off when it is in STANDBY mode.

Remote External Sensor **25**

This 3.5 mm mini-jack receives command codes from industry-standard infrared receivers (Xantech, etc.) via hard-wired connections. This feature could prove useful when the unit is installed in a cabinet and the front-panel sensor is blocked. Consult your authorized Rotel dealer for information on these external repeaters and the proper wiring of a jack to fit the mini-jack receptacle.

Specifications

All specifications are accurate at the time of printing.

Rotel reserves the right to make improvements without notice.

Rotel and the Rotel HiFi logo are registered trademarks of The Rotel Co, Ltd., Tokyo, Japan.

Audio

Continuous Amplifier Power:	100 watts/channel (20–20k Hz, <0.05% THD, 8 ohms)
Total Harmonic Distortion:	<0.05% at rated power
Intermodulation Distortion (60 Hz: 7 kHz):	<0.05% at rated power
Frequency Response:	Line Level: 10 Hz - 70 kHz, ± 3 dB Phono: 20 Hz - 20 kHz, ± 1.5 dB
Signal to Noise Ratio (IHF "A" weighted):	92 dB
Input Overload:	Line Inputs: 5 V Phono Inputs: > 120 mV
Preamplifier Output Voltage:	1.1 V
Input Sensitivity/Impedance:	Line Level: 200 mV/47 kohms Phono: 3.1 mV/47 kohms
Tone Controls (Bass/Treble):	± 8 dB at 100 Hz/10 kHz

Video

Frequency Response:	3 Hz-10 MHz, ± 3 dB
Signal to Noise Ratio:	45 dB
Input Impedance:	75 ohms
Output Impedance:	75 ohms
Output Level:	1 volt

FM Tuner

Usable Sensitivity:	14.2 dBf
50dB Quieting Sensitivity:	20.2 dBf (mono) 45.3 dBf (stereo)
Signal to Noise Ratio (at 65 dBf):	70 dBf (mono) 65 dBf (stereo)
Harmonic Distortion (at 65 dBf):	0.3% (mono) 0.5% (stereo)
Frequency Response:	30 Hz-14 kHz, ± 1.5 dB
Capture Ratio:	2.0 dB
Alternate Channel Selectivity:	47 dB (± 400 kHz)
Spurious Response Ratio:	80 dB
Image Response Ratio:	65 dB
IF Response Ratio:	80 dB
AM Suppression Ratio:	52 dB
Stereo Separation (100Hz/1 kHz/10 kHz):	40 dB/45 dB/35 dB
Output level:	550 mV
Antenna Input:	75 ohms unbalanced

AM Tuner

Sensitivity:	500 μ V/m
Selectivity:	25 dB
Image Response Ratio:	35 dB
Signal to Noise Ratio:	40 dB
Output level:	160 mV
Antenna Input:	Loop Antenna

General

Power Consumption:	350 watts
Power Requirements (AC):	120 volts, 60 Hz (USA version) 230 volts, 50 Hz (European version)
Weight:	11.5 Kg/25.4 lb.
Dimensions (W x H x D):	450 x 158 x 400 mm 173/4" x 61/4" x 153/4"

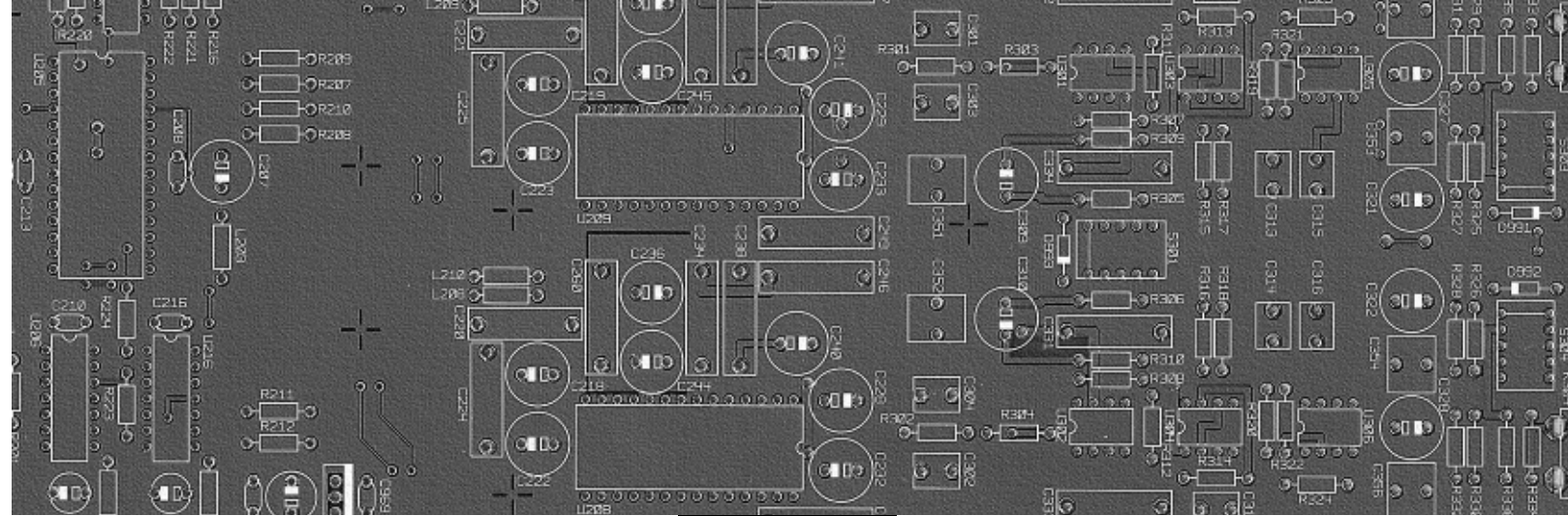

ROTEL

The Rotel Co. Ltd.

10-10 Shinsen-Cho
Shibuya-Ku
Tokyo 150-0045
Japan
Phone: +81 3-5458-5325
Fax: +81 3-5458-5310

Rotel of America

54 Concord Street
North Reading, MA 01864-2699
USA
Phone: +1 978-664-3820
Fax: +1 978-664-4109

Rotel Europe

Meadow Road
Worthing, West Sussex BN11 2RX
England
Phone: +44 (0)1903 524 813
Fax: +44 (0)1903 524 831

Rotel Deutschland

Kleine Heide 12
D-33790 Halle/Westf.
Germany
Phone: +49 05201-87170
Fax: +49 05201-73370

082 OMRX-975ENG 042499

Free Manuals Download Website

<http://myh66.com>

<http://usermanuals.us>

<http://www.somanuals.com>

<http://www.4manuals.cc>

<http://www.manual-lib.com>

<http://www.404manual.com>

<http://www.luxmanual.com>

<http://aubethermostatmanual.com>

Golf course search by state

<http://golfingnear.com>

Email search by domain

<http://emailbydomain.com>

Auto manuals search

<http://auto.somanuals.com>

TV manuals search

<http://tv.somanuals.com>