

ROTEL *hi fi*

BELT-DRIVE STEREO TURNTABLE

RP-855

owner's manual

使用説明書

ENGLISH.....	2
DEUTSCH	6
FRANÇAIS	10
日本語	14

WARNING
TO PREVENT FIRE OR SHOCK HAZARD
DO NOT EXPOSE THIS APPLIANCE
TO RAIN OR MOISTURE

Write your SERIAL NUMBER here.
The number is located near the name
plate on the rear panel.

SAFETY INSTRUCTIONS

WARNING: To reduce the risk of fire or electric shock, do not expose this appliance to rain or moisture.

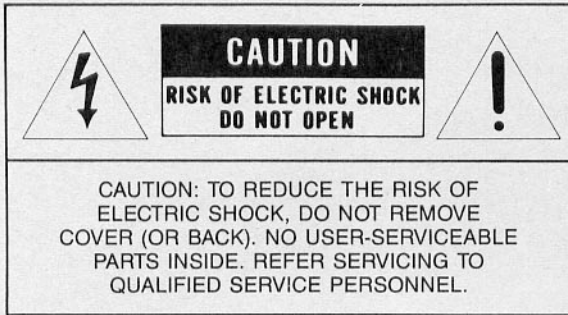

• Explanation of Graphical Symbols

The lightning flash with arrowhead symbol, within an equilateral triangle, is intended to alert the user to the presence of uninsulated "dangerous voltage" within the product's enclosure that may be of sufficient magnitude to constitute a risk of electric shock to persons.



The exclamation point within an equilateral triangle is intended to alert the user to the presence of important operating and maintenance (servicing) instructions in the literature accompanying the appliance.



- 1. Read Instructions** — All the safety and operating instructions should be read before the appliance is operated.
- 2. Retain Instructions** — The safety and operating instructions should be retained for future reference.
- 3. Heed Warnings** — All warnings on the appliance and in the operating instructions should be adhered to.
- 4. Follow Instructions** — All operating and use instructions should be followed.
- 5. Water and Moisture** — The appliance should not be used near water — for example, near a bathtub, washbowl, kitchen sink, laundry tub, in a wet basement, or near a swimming pool, and the like.
- 6. Carts and Stands** — The appliance should be used only with a cart or stand that is recommended by the manufacturer.
- 6A.** An appliance and cart combination should be moved with care. Quick stops, excessive force, and uneven surfaces may cause the appliance and cart combination to overturn.

**PORTABLE
CART
WARNING**



S3125A

- 7. Wall or Ceiling Mounting** — The appliance should be mounted to a wall or ceiling only as recommended by the manufacturer.
- 8. Ventilation** — The appliance should be situated so that its location or position does not interfere with its proper ventilation. For example, the appliance should not be situated on a bed, sofa, rug, or similar surface that may block the ventilation openings; or, placed in a built-in installation, such as a bookcase or cabinet that may impede the flow of air through the ventilation openings.
- 9. Heat** — The appliance should be situated away from heat sources such as radiators, heat registers, stoves, or other appliances (including amplifiers) that produce heat.
- 10. Power Sources** — The appliance should be connected to a power supply only of the type described in the operating instructions or as marked on the appliance.
- 11. Grounding or Polarization** — The precautions that should be taken so that the grounding or polarization means of an appliance is not defeated.
- 12. Power-Cord Protection** — Power-supply cords should be routed so that they are not likely to be walked on or pinched by items placed upon or against them, paying particular attention to cords at plugs, convenience receptacles, and the point where they exit from the appliance.
- 13. Cleaning** — The appliance should be cleaned only as recommended by the manufacturer.
- 14. Nonuse Periods** — The power cord of the appliance should be unplugged from the outlet when left unused for a long period of time.
- 15. Object and Liquid Entry** — Care should be taken so that objects do not fall and liquids are not spilled into the enclosure through openings.
- 16. Damage Requiring Service** — The appliance should be serviced by qualified factory authorized service personnel when:
 - A. The power-supply cord or the plug has been damaged; or
 - B. Objects have fallen, or liquid has been spilled into the appliance; or
 - C. The appliance has been exposed to rain; or
 - D. The appliance does not appear to operate normally or exhibits a marked change in performance; or
 - E. The appliance has been dropped, or the enclosure damaged.
- 17. Servicing** — The user should not attempt to service the appliance beyond that described in the operating instructions. All other servicing should be referred to qualified factory authorized service personnel.

ENGLISH

BELT-DRIVE STEREO TURNTABLE RP-855

INTRODUCTION

We at Rotel want to thank you for purchasing our audio product.

Rotel audio products are designed to use the latest electronic technology, and they incorporate our long experience as a specialist manufacturer of audio equipment. We are confident that you will find satisfaction in the high quality sound and top performance, and that you will find pleasure in the functional beauty achieved through human-engineering concept. Before starting operation, please read this instruction manual thoroughly and acquaint yourself with the proper mode of using the unit and all its connections.

We hope you will enjoy top-notch performance for many years to come.

UNPACKING

Counterweight and hinges for dustcover are packed inside the styrofoam molding. Platter and rubber mat are packaged separately and placed beneath the body of the unit.

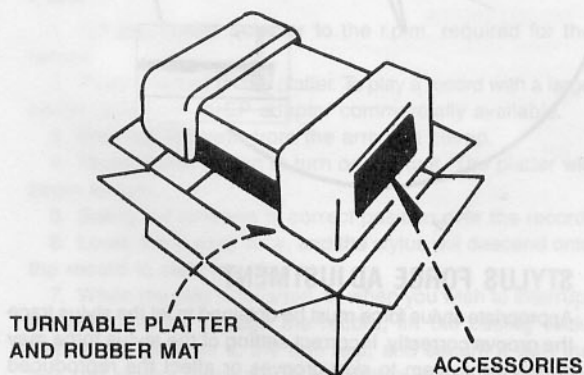

PART NAMES

- (1) Turntable spindle
- (2) Turntable platter/rubber mat
- (3) Speed selector
- (4) Power button
- (5) Headshell
- (6) Tonearm
- (7) Arm rest/arm clamp
- (8) Cueing stick
- (9) Antiskating device
- (10) Stylus force gauge
- (11) Counterweight
- (12) Pulley (beneath the platter)

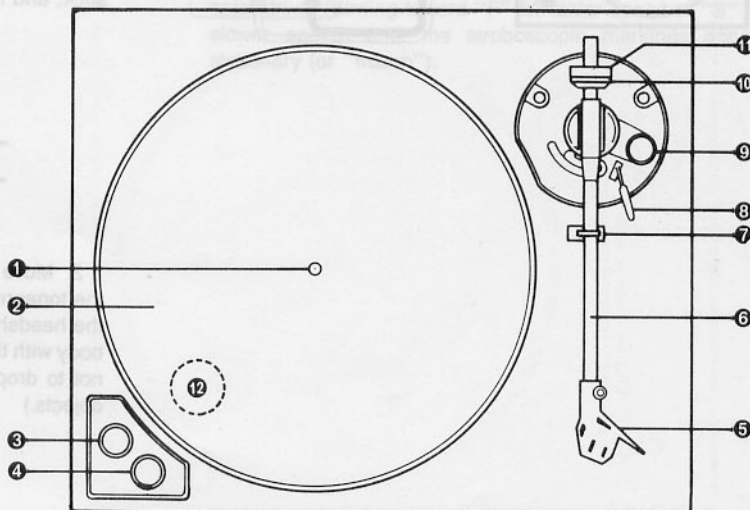

EXCLUSIVE NOTE FOR U.K.

If your unit comes with a 2-core cable without a plug, make certain live and neutral leads are connected to the proper terminals. Check that the terminals are screwed down firmly and no loose strands of wire are present.

IMPORTANT: The wires in this mains lead are coloured in accordance with the following code:

BLUE: NEUTRAL

BROWN: LIVE

As the colours of the wires in the mains lead of this apparatus may not correspond with the coloured markings identifying the terminals in your plug proceed as follows. The wire which is coloured BLUE must be connected to the terminal which is marked with the letter N or coloured BLUE or BLACK. The wire which is coloured BROWN must be connected to the terminal which is marked with the letter L or coloured BROWN or RED.

INSTALLATION

To prevent hum, do not place the unit near appliances with motors or large transformers. Be sure the unit's location is not subject to high temperature, humidity, or direct sunlight, to prevent possible troubles.

Vibration or tilted installation will impede good performance of the turntable and the stylus will skip grooves.

ASSEMBLING THE TURNTABLE

1. There are two large holes in the center of the turntable platter, one into which the center spindle is inserted and the other through which the belt is installed. By inserting a finger through the larger hole, the finger can hook onto the rubber belt inside the turntable.

2. By placing the turntable platter onto the spindle, the platter will adjust itself to match the spindle. The finger inserted through the larger hole can then set the belt onto the pulley.

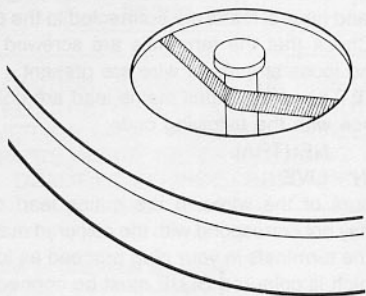

3. When the turntable is manually turned two or three times around, the belt will settle onto the pulley and the platter will also adjust itself accordingly.

4. Place the rubber mat onto the turntable platter.

5. With the stylus force gauge set toward the front, install the counterweight onto the rear end of the tone arm by turning it to the right.

CONNECTION TO AMPLIFIER OR RECEIVER

The unit is provided with RCA cords for both channels, and a ground wire. The RCA cord with white plug should be connected to L (left channel) of PHONO terminals and the cord with red plug to R (right channel) of PHONO terminals on the amplifier or receiver. Connect the ground wire to GND terminals on the amplifier or receiver.

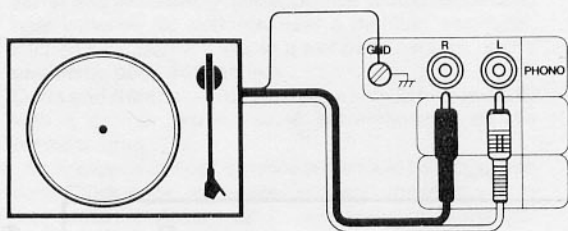

OVERHANG ADJUSTMENT

Though this turntable has been adjusted prior to shipping, the overhang can be further adjusted if required.

• Use a rule, etc. to carry out correct adjustment.

As shown in the illustration, overhang indicates the distance from the stylus tip to the center of the turntable spindle when the stylus tip falls on the extension of a straight line from the pivot of the tonearm to the center of the spindle. If the overhang adjustment is not properly made, the stylus will not be able to trace the record grooves correctly.

1. Loosen the two cartridge mounting screws.
2. Position the tonearm over the spindle.
3. Slide the cartridge forward or backward until the position of the stylus tip corresponds to the specified distance from the center of spindle (see illustration).
4. After obtaining correct overhang, tighten the two cartridge mounting screws firmly.

Note: Be careful not to touch stylus during adjustment with fingers.

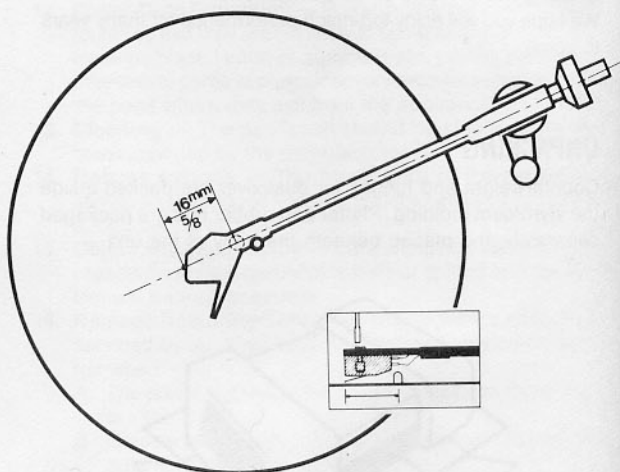

STYLUS FORCE ADJUSTMENT

Appropriate stylus force must be obtained to let the stylus trace the groove correctly. Incorrect setting of the stylus force may cause the system to skip grooves or affect the reproduced sound quality.

1. Set the antiskating knob to 0 position. Lower the cueing stick, and release the tonearm from the arm rest.

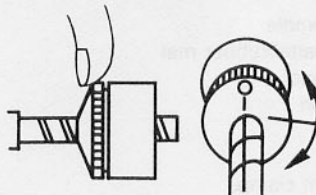

2. Move the counterweight forward and backward so that the tonearm will be balanced horizontally. When balanced, the headshell is raised and the tonearm parallels the main body with the tonearm base as fulcrum. (Caution: Be careful not to drop the stylus or hit it against the platter or other objects.)

3. Return the tonearm onto the arm rest. Turn the gauge ring of the counterweight so that 0 point falls on the reference marker on the tonearm.

4. Turn the counterweight to preset the reading on the gauge to the designated stylus force of your cartridge. Do not touch the gauge ring, as it will turn with the counterweight.

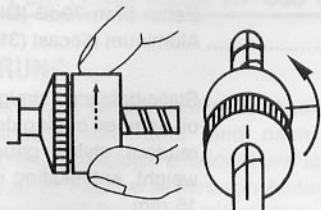

5. Turn and set the anti-skating knob to the value same as the stylus force of your cartridge. Stylus force adjustment is now complete.

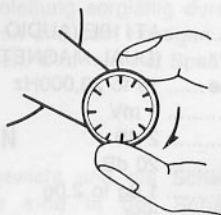

PLAY

1. Set the Speed Selector to the r.p.m. required for the record.

2. Place a record on the platter. To play a record with a large center hole, use an EP adaptor commercially available.

3. Free the tonearm from the arm rest clamp.

4. Press Power button to turn on the unit. The platter will begin to turn.

5. Swing the tonearm to correct position over the record.

6. Lower the cueing stick, and the stylus will descend onto the record to start the play.

7. When the play is finished, or when you wish to interrupt the play midway through the record, lift the cueing stick. Return the tonearm to the arm rest, and secure it with the arm rest clamp. Press the Power button to turn off the unit, and the platter will stop turning.

BEZEICHNUNG DER TEILE

- (1) Plattenhalter-Mittelschne
- (2) Plattenhalter-Gummihülse
- (3) Geschwindigkeitswähler
- (4) Netzschalter
- (5) Tonkopflage
- (6) Tonarm
- (7) Tonarmstütze/Vergelung
- (8) Tonarmhülse
- (9) Anti-Skating-Einstellung
- (10) Aufhebelmechanik
- (11) Gegengewicht
- (12) Riemenscheibe (unterhalb des Plattentellers)

FINE-ADJUSTING THE SPEED

Though this turntable has been adjusted prior to shipping, the rotation speed of the platter can be further adjusted if required. The two screws at the bottom of the turntable, one for 33 1/3 rpm and the other for 45 rpm can be adjusted to achieve a more accurate speed. Make these adjustments under the light of the fluorescent lamp.

1. Place the stroboscopic template onto the turntable platter in the same manner as when playing records.

2. Set two stands of equal height (tables or boxes, etc.) about 10 cm (4 inches) apart, and place the turntable onto them as if forming a bridge. Be sure that the turntable is as perfectly level as possible when doing this.

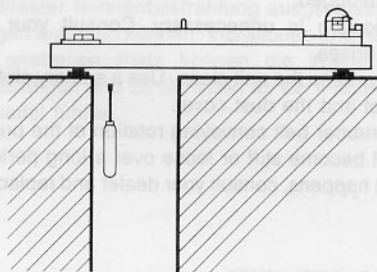

3. Look at the bottom of the turntable to ensure that the holes to the two adjustment screws are visible. (If they are not, then readjust the stands and the turntable until the holes appear.)

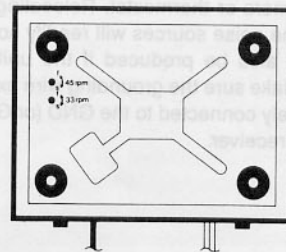

4. On the stroboscope, there are two markings of 50 Hz and 60 Hz for each of the two speeds, 33 1/3 rpm and 45 rpm. Keep your eye on these stroboscopic markings while making adjustments.

5. Turn on the power and select the desired speed by pressing the appropriate selector button.

6. Adjust the screws at the bottom of the turntable with a screwdriver (turning toward "F" for faster speed or "S" for slower speed) until the stroboscopic markings appear stationary (or "frozen").

MAINTENANCE

1. Keep the stylus tip clean of dust. Clean the stylus carefully using a soft brush, and also clean the record before commencing play.

2. The stylus tip is very sensitive. Be careful not to touch it with a finger nor let it come in contact with solid objects.

3. The stylus is usually good for about 500 to 1,000 hours of continuous playing. A worn stylus will cause the record to be distorted and the record to be damaged. Be sure to use the correct replacement stylus matching your cartridge.

4. Do not move the turntable when it is operating. Never try to stop the platter forcibly by hand while it is rotating.

5. When replacing cartridge or stylus, make sure the power cord is unplugged.

6. Lubrication is unnecessary. Consult your dealer if necessity arises.

7. Always keep the unit clean. Use a soft dry cloth to clean the cabinet and the dust cover.

8. The rubber belt conveying rotation of the pulley to the platter will become stiff or loose over a long period of use. When that happens, consult your dealer and replace the belt.

HOWLING AND HUM

Howling is usually caused by vibration of speakers, which affects the sensitive cartridge. If such a phenomenon occurs, relocate the turntable or speakers as far apart from each other as possible. Hum is usually caused by nearby appliances that use transformers or thermostat. Relocating the unit further away from the noise sources will readily solve the problem. A hum may also be produced if the unit is not properly grounded. Make sure the grounding wire extending from the unit is securely connected to the GND (or G) terminal on the amplifier or receiver.

SPECIFICATIONS

Motor	DC Servo motor
Drive System	Belt-drive
Speeds	33-1/3 and 45 rpm
Wow and flutter.....	Less than 0.03% (WRMS)
Signal-to-Noise Ratio.....	Better than 60dB (IEC-B) Better than 70dB (DIN-B)
Platter	Aluminum diecast (310mm, 1.5kg)

TO NEARM

Type.....	Static-balanced straight pipe arm, oil-damped cueing device, direct- readout stylus gauge counter- weight, anti-skating device.
-----------	--

Overhang.....	16 mm
Tracking Error	+2.35° to -1.3°

Suitable Cartridge	
Weight	3g to 9g
Suitable Stylus Pressure..	0.5g to 3g

CARTRIDGE

Cartridge.....	AT110E (AUDIO TECHNICA) (DUAL MAGNET)
----------------	--

Frequency Response	15 to 20,000Hz
--------------------------	----------------

Sensitivity	3 mV
-------------------	------

Channel Balance	2 dB
-----------------------	------

Channel Separation	20 dB
--------------------------	-------

Stylus Pressure.....	1.0g to 2.0g
----------------------	--------------

Tracking Angle	23°
----------------------	-----

Load Resistor	47 kohms
---------------------	----------

Replacement Stylus.....	ATN110E
-------------------------	---------

Net Weight	7g
------------------	----

MISCELLANEOUS

Power Requirement	120V (60Hz) or 220/240V (50Hz)
-------------------------	--------------------------------

Power Consumption.....	5 watts
------------------------	---------

Dimensions (overall).....	432 (W) × 135 (H) × 350 (D) mm 17" × 5-5/16" × 13-25/32"
---------------------------	---

Weight (net).....	7.7kg/16.94 lbs.
-------------------	------------------

- Specifications subject to change for improvement without prior notice.

Free Manuals Download Website

<http://myh66.com>

<http://usermanuals.us>

<http://www.somanuals.com>

<http://www.4manuals.cc>

<http://www.manual-lib.com>

<http://www.404manual.com>

<http://www.luxmanual.com>

<http://aubethermostatmanual.com>

Golf course search by state

<http://golfingnear.com>

Email search by domain

<http://emailbydomain.com>

Auto manuals search

<http://auto.somanuals.com>

TV manuals search

<http://tv.somanuals.com>