

Rowenta

PRO COMPACT
COMPACT GARMENT STEAMER

1103901405 - 03/07



www.rowentausa.com

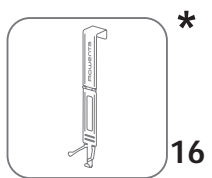
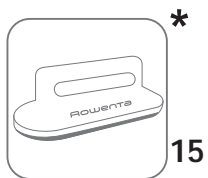
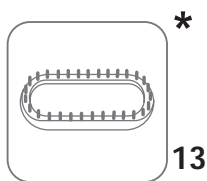
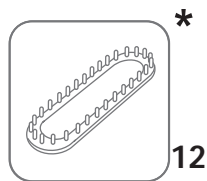
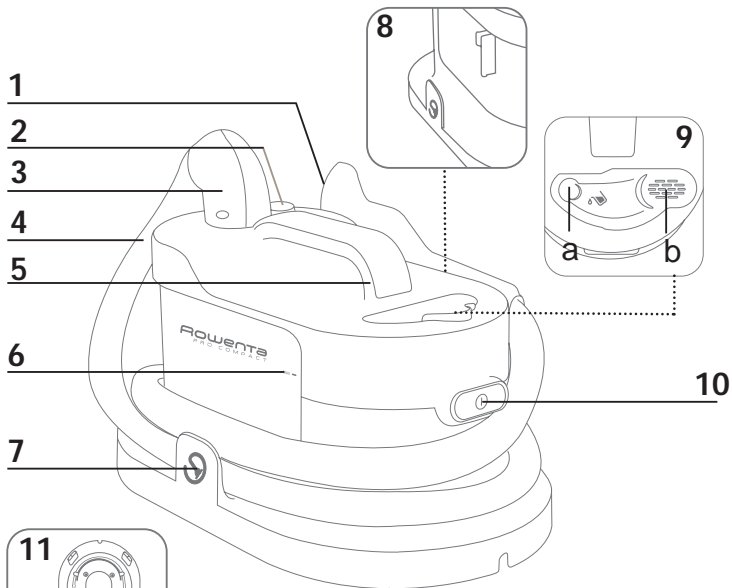

* Depending on Model: Accessories are specific to certain models or available as an optional accessory.

IMPORTANT SAFETY INSTRUCTIONS

When using your appliance, basic precautions should always be followed, including the following:

Read all instructions before use.

- Use appliance for its intended use only.
- This appliance is not designed to be used by people (including children) with a physical, sensory or mental impairment, or people without knowledge or experience, unless they are supervised or given prior instructions concerning the use of the appliance by someone responsible for their safety.
- Children must be supervised to ensure that they do not play with the appliance.
- Do not leave appliance unattended while plugged in or while it is still hot.
- Do not operate any appliance with a damaged cord, plug or steam hose or after the appliance malfunctions, or is dropped or damaged in any manner.
- To reduce the risk of electric shock, do not disassemble or attempt to repair the appliance. Return appliance to nearest authorized service center for examination, repair or adjustment.
- To reduce the risk of contact with hot water emitting from steam vents, check appliance before each use by holding it away from body and operating.
- Steam only in an up and down vertical motion. Never use steam head in a horizontal position or tilt into a backward position, this may result in water discharge.
- To reduce the risk of electric shock, do not immerse the appliance in water or other liquids.
- Appliance should always be turned off before plugging or unplugging. Never yank the cord to disconnect from outlet, instead grasp plug and pull to disconnect.
- Do not allow cord to touch hot surfaces. Let appliance cool completely before putting away.
- Loop cord loosely under the appliance when storing.
- Do not let power cord contact sharp edges or hot surfaces.
- Do not try to fasten the hose adapter during operation. Scalding may occur if the hose adapter is removed while using the appliance.
- Always disconnect appliance from electrical outlet when filling with water, emptying or when not in use.
- Do not attempt to hang up the unit using the hose.
- The use of foreign accessory attachments that are not supplied by Rowenta is not recommended and may result in fire, electric shock or personal injury.
- Burns could occur from touching hot parts, hot water or steam. Use care when you empty a steam appliance. There may be hot water in the reservoir.
- Do not direct steam at people, animals or steam clothes while they are being worn.
- Your Rowenta appliance is intended for household use only.
- This is a floor appliance and should never be carried while in use.

SPECIAL INSTRUCTIONS

- This is a 1300, 1400 or 1500 watt appliance. To avoid a circuit overload, do not operate a high wattage appliance on the same circuit.
- If an extension cord is absolutely necessary, the marked electrical rating should be at least as great as the electrical rating of the appliance. Cords rated for less amperage may overheat. Care should be taken to arrange the cord so that it cannot be pulled or tripped over.
- Do not cut or attempt to extend the steaming hose.

DESCRIPTION

- | | |
|-----------------------------|---|
| 1. Steam head | 10. On / Off switch |
| 2. Eject button | 11. Electric cord storage
(under base) |
| 3. Steam hose connector | |
| 4. Steam hose | |
| 5. Carry handle | 12. Upholstery brush* |
| 6. Max water level | 13. Fabric brush* |
| 7. Steam hose wrapping | 14. Crease attachment* |
| 8. Steam head storage slide | 15. Lint pad* |
| 9.a Filling inlet | 16. Door hook* |
| 9.b Emptying outlet | |

*depending on model: this is either equipment specific to certain models or available as an optional accessory. Accessories that are not listed in this manual or manufactured by other companies are not recommended for use with the Pro Compact steamer.

Before use

Please read the instructions for use and Important Safeguards carefully.

- Remove any packaging from the appliance.
- **DO NOT PLUG IN OR TURN ON UNTIL ASSEMBLY IS COMPLETE.**

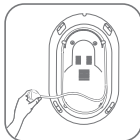

- Insert the steam hose into the hole on the top of the unit while sliding out the eject knob.



- Completely unwind the power cord.

Filling with water

• Your steamer has been designed to operate using untreated tap water. If your water is very hard (check with your local water authority) mix tap water with store-bought bottled or spring water in the following proportions :

- 50% untreated tap water,
- 50% distilled or demineralized water.
- or just use bottled spring water.

• Fill with maximum 33 ounces of water, taking care that the water does not overflow or pass the fill line on the side of the tank.

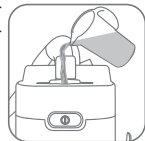

Never overfill your steamer. Never fill it with hot water.

Important: Heat concentrates the elements contained in water during evaporation. The types of water listed hereafter may contain organic waste, mineral or chemical elements that can cause spitting, brown staining, or premature wear of the appliance: water from clothes dryers, scented or softened water, water from refrigerators, batteries, air conditioners, rain water, boiled, filtered or bottled water. Also use distilled or demineralized water only as advised above.

Use

- **Plug in your steamer. Place your steamer on the floor with the steam vents pointing away from the door.**
- The steam head should be hung on the door hook while unit is heating up.

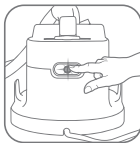
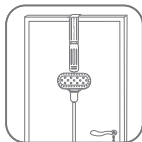

- Press on the On / Off switch, the power indicator light will illuminate once steamer is turned on.
 - Wait for the steam to come out. It will take approximately 21/2 minutes.
 - Remove the steamer head and place your garment onto the hanger head.
- Grasp the steam head handle with the steam vents pointing away from you. Start steaming by touching material lightly with steaming head and moving in an up/down vertical motion. Begin at the top of the garment and **move in a downward direction**. Steam with hose in an upright position, this allows any condensation to flow back into the steamer.



Tips: Always check fabric labels for recommendations. Test fabric for color fastness in an unobtrusive part of the garment (inner seam). Do not touch silk or velvet with steam head. Some articles can be steamed better from the underside.

If steaming in a low position near floor, straighten hose up and out frequently to clear condensation. If hose becomes clogged, it will make a gurgling noise or the amount of steam will be reduced.

You may also experience dripping if the hose becomes clogged.

Heavier fabrics may require repeated steaming. Exercise caution at all times.

- During operation, the steamer hose may make a gurgling noise. This is a normal result of condensation. If it begins to gurgle, extend hose up and out to move excess moisture back into the base.

Warning: Never steam clothes while they are being worn. Hose and steam head will become hot during use. This is normal. Use caution and avoid prolonged contact.

Accessories (depending on model)

Never touch the steam head until it cools completely.

Before using any of the accessories on upholstery or garments, be sure to consult the manufacturer's labels regarding their recommendations for garment care. We also recommend testing on an unobtrusive area.

Reminder: When using accessories steam only in an up and down vertical motion. Never use the steam head in a horizontal position and never steam with your steam head upside down.

Upholstery brush*

Be sure unit is unplugged and completely cool before attaching accessories.

The upholstery brush is used to aid steam penetration into difficult or heavy fabrics for faster results.

• Attach the upholstery brush to the steam head by lining up the bottom of the brush with the bottom of the steam head. Gently push the top of the brush into place on the steam head until it clicks into place.

• Gently brush the area to be steamed with the grain or nap of the fabric.

• Remove the upholstery brush once unit is unplugged and completely cool. Remove it by pressing on the tab on top of brush while pulling it forward.

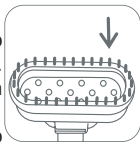

Fabric brush*

Be sure unit is unplugged and completely cool before attaching accessories.

The fabric brush opens weave of the fabrics for better steam penetration.

• Attach the fabric brush to the steam head by lining up the bottom of the brush with the bottom of the steam head. Gently push the top of the brush into place on the steam head until it clicks into place.

• Gently brush the area to be steamed with the grain or nap of the fabric.

• Remove the fabric brush once unit is unplugged and completely cool by pressing on the release tab on top of brush while pulling it forward.

*depending on model: this is either equipment specific to certain models or available as an optional accessory.

Crease attachment*

Be sure unit is unplugged and completely cool before attaching accessories.

The crease attachment is used to make pant creases easily or to remove stubborn wrinkles.

- Fasten the crease attachment to the steamer by sliding onto the steam head so it fits over the raised channels.
- Gently push into place.
- Push on the handle to open the crease attachment.
- Put your fabric in the space between the crease attachment and the head of the steam brush.
- Release the handle.
- Move the crease attachment in a downwards motion starting from the top.
- Once unit is unplugged and completely cool, remove the crease attachment by sliding it off of the steam brush.



Lint pad*

The lint pad is a separate accessory and cannot be attached to the steam head. You can use the lint pad independently from the steamer.

The lint pad removes hair, lint and animal fur for a professional finish.

- To use the lint pad, slowly brush the clothing with the grain or nap of the fabric.
- The pad can be cleaned by brushing in the opposite direction. We recommend cleaning on an old cloth that can be discarded.

*depending on model: this is either equipment specific to certain models or available as an optional accessory.

After use

• After using the steamer, switch the power off (power indicator light will go out) and unplug the appliance. Wind the power cord on its storage place under the appliance.

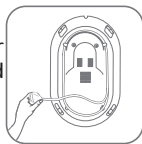

• Remove the steam hose.

Be careful there may be hot water remaining in the steam hose after use. Always remove the steam hose before emptying your appliance.

• Empty the water container from the opening shown in diagram 9b.



• Place the steam connector back into place. Wrap the hose around the steamer and insert the steam head onto its housing. The head slides over the raised channels for secure storage.

• You can carry your steamer by its handle for easy portability and storage.

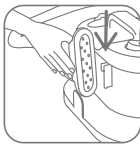
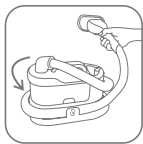

For cord winding or transport, never turn your appliance upside down. Empty all water from the unit before storing it.

Cleaning

Clean the main unit with a damp cloth. To maintain maximum performance, your steamer must be descaled occasionally. The descaling intervals will depend on the water quality and the frequency of use. The unit should be descaled at least once a year or every 100 hours of use. For descaling proceed as follows:

1. Unplug the unit and fill it with 1/3 white vinegar and 2/3 water.
2. Let the appliance run for 3 minutes and do not steam any clothing with this mixture.
3. Switch the appliance off. Unplug it and allow to cool down for at least 30 minutes.
4. Empty the water over the sink. Rinse the appliance with fresh water.
5. Fill the unit with fresh water and repeat steps 2-4.

If after descaling you believe that there is still buildup in the appliance, repeat this operation. Use a new solution of vinegar and water each time you repeat steps 1 and 2.

TROUBLESHOOTING

Problems	Possible causes	Solutions
There is no steam.	The steamer is not turned on.	Check that your appliance is correctly plugged in and press the illuminated on/off switch (on the front of the base).
	The water level is too low.	Turn your appliance off and refill it to the max line on the side of the water tank.
	The hose is kinked.	Be sure that the hose is fully unraveled.
	There is no more water.	Unplug your steamer and refill it.
There is little steam.	Your steamer has a build-up of scale because it has not been rinsed out regularly.	Descal the steamer and descall at least once a year or every 100 hours of use. If your water is hard, increase the frequency.
	The water level is too low.	Turn your appliance off and refill it.
	There is too much water.	Unplug your steamer and empty it partially.
Water runs through the holes of the steambrush.	There is condensation in the hose.	Never use steamer in a horizontal position. Hold the hose vertically outstretched and wait for water to flow back into the steamer.
The steamer takes a long time to heat.	Your steamer has a build-up of scale because it has not been descaled regularly.	Rinse out the steamer at least once a year or every 100 hours of use. If your water is hard, increase the frequency.
	There is too much water.	Unplug your steamer and empty it partially.

In the interest of improving products, Rowenta reserves the right to change specifications without prior notice.

LIMITED WARRANTY

This Rowenta product is warranted for 1 year from date of purchase against defects in material and workmanship. During this period, any Rowenta product that, upon inspection by Rowenta, is proved defective, will be repaired or replaced, at Rowenta's option, without charge to the customer. If a replacement product is sent, it will carry the remaining warranty of the original product. This warranty does not apply to any defect arising from a buyer's or user's misuse of the product, negligence, failure to follow Rowenta's instructions, use on current or voltage other than that stamped on the product, or alteration or repair not authorized by Rowenta. Repair or disassembly by anyone other than a Rowenta authorized service center will void the warranty.

THE WARRANTIES SET FORTH HEREIN ARE EXCLUSIVE AND NO OTHER WARRANTIES, EXPRESS OR IMPLIED, INCLUDING BUT NOT LIMITED TO ANY WARRANTY OF MERCHANTABILITY OR FITNESS FOR A PARTICULAR PURPOSE OR USE, ARE MADE BY ROWENTA OR ARE AUTHORIZED TO BE MADE WITH RESPECT TO THE PRODUCT. Some states do not allow limitations on how long an implied warranty lasts or do not allow the exclusion of incidental or consequential damages, so the above limitations may not apply to you. This warranty gives you specific legal rights, and you may also have other rights, which vary from state to state.

If you believe your product is defective, bring the product (or send it, postage prepaid) along with proof of purchase to the nearest authorized Rowenta Service Center (see below). If you send the product, please include a letter explaining the nature of the claimed defect.

CORRESPONDENCE CAN BE SENT TO:

ROWENTA
196 Boston Avenue
Medford, MA 02155, U.S.A.
Tel: (781) 396-0600
www.rowentausa.com

OFFICE LOCATION ONLY. Letters will be accepted at this address and packages without a return authorization number will be refused or forwarded to a service center. To service product see service center information below.

SERVICE CENTER INFORMATION:

If your appliance needs service, ship the product to your nearest regional service center. Be sure to put your name on the outside of the shipping box (no P.O. boxes please), include a brief note describing the issue, and include a copy of the sales receipt if the product is in warranty. If in warranty, Rowenta will repair or replace the product at their discretion. If the product is out of warranty, you will be advised of the cost of repair before any work begins.

Turnpike Appliance
California Electric
3495A Lawson Blvd.
1170G Burnett Ave.
Oceanside, NY 11572
Concord, CA 94520
516-483-5596
925-827-1011

Authorized Appliance
1644 West Ogden Ave.
Downers Grove, IL 60515
630-852-1550

California Electric
1170G Burnett Avenue
Concord, CA 94520
925-827-1011

SERVICE CENTER INFORMATION IS SUBJECT TO CHANGE. Please visit our website at www.rowentausa.com or call 781-396-0600 for automated service center information.

Free Manuals Download Website

<http://myh66.com>

<http://usermanuals.us>

<http://www.somanuals.com>

<http://www.4manuals.cc>

<http://www.manual-lib.com>

<http://www.404manual.com>

<http://www.luxmanual.com>

<http://aubethermostatmanual.com>

Golf course search by state

<http://golfingnear.com>

Email search by domain

<http://emailbydomain.com>

Auto manuals search

<http://auto.somanuals.com>

TV manuals search

<http://tv.somanuals.com>