



RuggedBackbone™ RX1501

Hardware Installation Guide



Revision 104 - October 14, 2011

www.RuggedCom.com

RuggedBackbone™ RX1501: Hardware Installation Guide

Copyright © 2011 RuggedCom Inc.

All Rights Reserved

Dissemination or reproduction of this document, or evaluation and communication of its contents, is not authorized except where expressly permitted. Violations are liable for damages. All rights are reserved, particularly for the purposes of patent application or trademark registration.

This document contains proprietary information, which is protected by copyright. All rights are reserved. No part of this document may be photocopied, reproduced or translated to another language without the prior written consent of RuggedCom Inc.

Disclaimer Of Liability

We have checked the contents of this manual against the hardware and software described. However, deviations from the description cannot be completely ruled out.

RuggedCom shall not be liable for any errors or omissions contained herein or for consequential damages in connection with the furnishing, performance, or use of this material.

The information given in this document is reviewed regularly and any necessary corrections will be included in subsequent editions. We appreciate any suggested improvements. We reserve the right to make technical improvements without notice.

Registered Trademarks

ROX™, RuggedRated™ and eRSTP™ are trademarks of RuggedCom Inc. RuggedRouter® is a registered trademark of RuggedCom Inc. RuggedBackbone™ is a trademark of RuggedCom Inc. Other designations in this manual might be trademarks whose use by third parties for their own purposes would infringe the rights of the owner.

Linux® is the registered trademark of Linus Torvalds in the U.S. and other countries.

The registered trademark Linux® is used pursuant to a sublicense from LMI, the exclusive licensee of Linus Torvalds, owner of the mark on a world-wide basis.

Warranty

Five (5) years from date of purchase, return to factory. For warranty details, visit www.RuggedCom.com or contact your customer service representative.

Contacting RuggedCom

Corporate Headquarters	US Headquarters	Europe Headquarters
RuggedCom Inc. 300 Applewood Crescent, Concord, Ontario Canada, L4K 5C7 Tel: +1 905 856 5288 Fax: +1 905 856 1995 Toll-free: 1 888 264 0006	RuggedCom 1930 Harrison Street, Suite 209 Hollywood, Florida USA, 33020 Tel: +1 954 922 7938 ext.103 Fax: +1 954 922 7984 Toll-free: 1 888 264 0006	RuggedCom Unit 41, Aztec Centre, Aztec West, Almondsbury, Bristol United Kingdom BS32 4TD Tel: +44 1454 203 404 Fax: +44 1454 203 403
Email: RuggedSales@RuggedCom.com		

Technical Support
Toll Free (North America): 1 866 922 7975 International: +1 905 856 5288 Email: Support@RuggedCom.com

Web: www.RuggedCom.com

Table of Contents

- FCC Statement And Cautions 8
- 1. Product Overview 9
 - 1.1. Functional Overview 9
 - 1.2. Feature Highlights 9
- 2. RuggedBackbone™ Modules 12
 - 2.1. Front Panel 13
 - 2.1.1. Module Status LEDs 13
 - 2.2. Line Modules (LM) 14
 - 2.2.1. Ethernet - Copper 14
 - 2.2.2. Ethernet - Fiber 14
 - 2.2.3. SFP Modular 15
 - 2.2.4. WAN 15
 - 2.2.5. Serial 15
 - 2.2.6. Cellular Modem 15
 - 2.2.7. DDS - Digital Data Services 16
 - 2.2.8. APE - Application Processing Engine 16
 - 2.3. Power Supply 17
- 3. Installation 18
 - 3.1. Rack Mounting 18
 - 3.1.1. Rack Mounting Dimensions 18
 - 3.1.2. Panel and DIN Rail Mounting 20
 - 3.1.3. Panel and DIN Rail Mounting Dimensions 21
 - 3.2. Power Supply Wiring and Grounding 22
 - 3.2.1. Connectors for HI and HIP Power Modules 22
 - 3.2.2. Connectors for 24, 24P, 48, and 48P Power Modules 22
 - 3.2.3. Chassis Ground Connection 23
 - 3.2.4. AC Power Supply Wiring Example 23
 - 3.2.5. DC Power Supply Wiring Example 24
 - 3.3. Critical Alarm Wiring 24
 - 3.4. Serial Console Port 25
 - 3.5. WAN Ports: RJ45 25
 - 3.6. WAN Ports: BNC 26
 - 3.7. Copper Ethernet Ports 26
 - 3.7.1. RJ45 Twisted-Pair Copper Ports 26
 - 3.7.2. Gigabit Ethernet 1000Base-TX Cabling Recommendations 26
 - 3.7.3. Transient Suppression 27
 - 3.8. Serial Ports: RJ45 28
 - 3.9. DDS Ports: RJ45 28
 - 3.10. DDS Rx and Tx LED Indications 29
 - 3.11. SFP Optics – Installation, removal, and precautions 29
 - 3.11.1. Module Insertion – SFP 30
 - 3.11.2. SFP Module Removal 30
 - 3.12. Fiber Ethernet Ports 31
 - 3.13. Cellular Modems 32
 - 3.13.1. GSM, EDGE, HSPA+ Cellular Modem Card 33
 - 3.13.2. Installing SIM Cards for GSM, EDGE, HSPA+ Cellular Modems 33

- 3.14. APE: Application Processing Engine 35
 - 3.14.1. APE Overview 35
 - 3.14.2. Supported Operating Systems 35
 - 3.14.3. Secondary Network Interface 36
 - 3.14.4. Installing an Operating System 37
 - 3.14.5. The APE BIOS 38
 - 3.14.6. Resetting the Module 38
 - 3.14.7. LED Indicators 38
 - 3.14.8. FAQs 39
- 4. Technical Specifications 40
 - 4.1. Power Supply Specifications 40
 - 4.2. Critical Alarm Relay Specifications 40
 - 4.3. Copper Ethernet Port Specifications 40
 - 4.4. Fiber Ethernet Port Specifications 41
 - 4.4.1. Fast Ethernet (100Mbps) Optical Specifications 41
 - 4.4.2. Gigabit Ethernet (1Gbps) Optical Specifications 42
 - 4.5. Operating Environment 42
 - 4.6. Mechanical Specifications 42
- 5. EMI And Environmental Type Tests 43
- 6. Agency Approvals 45
- 7. Warranty 46

List of Figures

2.1. RX1501 Chassis Slot Assignment	12
2.2. Front View - RX1501	13
2.3. CG01: 2 × 10/100/1000TX RJ45	14
2.4. 6TX01: 6 × 10/100/1000TX RJ45	14
2.5. FX**/FG**: 2 × 100FX/1000SX/1000LX LC	14
2.6. 4FX**: 4 × 100FC LC	14
2.7. FX03: 2 × 100 FX MTRJ	14
2.8. 4FX03: 4 × 100FX MTRJ	14
2.9. FX**: 2 × 100FX SC	14
2.10. FX**: 2 × 100FX ST	14
2.11. 10FL: 3 × 10FL ST	14
2.12. FG5*: 2 × 1000LX/1000SX SFP	15
2.13. FX5*: 4 × 100FX/100LX/100SX SFP	15
2.14. 6FX50: 6 × 100FX SFP	15
2.15. TC1: 1 × T1/E1 RJ45	15
2.16. E01: 1 × E1 BNC	15
2.17. TC2: 2 × T1/E1 RJ45	15
2.18. E02: 2 × E1 BNC	15
2.19. TC4: 4 × T1/E1 RJ45	15
2.20. 6S01: 6 × Serial RJ45	15
2.21. W11, W21, W32 Cellular Modem	15
2.22. W12, W22 Cellular Modem	15
2.23. D02: 1 × DDS RJ45	16
2.24. APE 1402	16
2.25. Screw terminal block power module: terminal cover in place (HI module shown)	17
2.26. Screw terminal block power module: terminal cover removed (HI module shown)	17
2.27. Pluggable terminal block power module (HIP module shown)	17
3.1. Side View of Mounting Brackets	18
3.2. RX1501Rack Mounting Dimensions – Front View	18
3.3. RX1501Rack Mounting Dimensions – Top View	19
3.4. RX1501Rack Mounting Dimensions – Rear View	19
3.5. Installing Panel and DIN Rail Mounting Brackets	20
3.6. DIN Rail Mounting	20
3.7. Panel and DIN Rail Mounting Dimensions	21
3.8. Screw Terminal Power Connector for HI Power Module	22
3.9. Pluggable Phoenix Power Connector for HIP Power Module	22
3.10. Screw Terminal Power Connector for 24 and 48 Power Modules	22
3.11. Pluggable Phoenix Power Connector for 24P and 48P Power Modules	22
3.12. Chassis Ground Connection	23
3.13. Wiring for Single AC Power Supply (HIP module shown)	23
3.14. Wiring for Single DC Power Supply (24P or 48P module shown)	24
3.15. Critical Alarm Relay Connector	24
3.16. DB9 Serial Console Port	25
3.17. RJ45 T1/E1 Pin Configuration	25
3.18. RJ45 T1/E1 Pin Configuration	26
3.19. RJ45 Ethernet Pin Configuration	26

- 3.20. RJ45 Serial Pin Configuration 28
- 3.21. RJ45 DDS Pin Configuration 28
- 3.22. DDS Module Rx and Tx LED Indicators 29
- 3.23. SFP module orientation 30
- 3.24. SFP module insertion 30
- 3.25. SFP module removal 31
- 3.26. LC 31
- 3.27. MTRJ 31
- 3.28. SC 31
- 3.29. ST 31
- 3.30. Single Port Cellular Modem: Antenna Connections 32
- 3.31. Dual Port Cellular Modem: Antenna Connections 32
- 3.32. Cellular Modem Module Assembly: W11 and W32 Single Antenna Modules 33
- 3.33. Cellular Modem Module Assembly: W12 Dual Antenna Modules 33
- 3.34. APE Faceplate and Ports 35
- 3.35. APE Chassis Network Connection 36

List of Tables

2.1. Module Status LED Indications	13
3.1. DB9 Serial Console Pinout	25
3.2. RJ45 T1/E1 Pin Assignment	25
3.3. RJ45 Ethernet Pin Assignment	26
3.4. Cabling Categories and 1000Base-TX Compliance	27
3.5. RJ45 RS232/RS485/RS422 Serial Pin Assignment	28
3.6. RJ45 DDS Pin Assignment	28
3.7. DDS Rx LED Indications	29
3.8. DDS Tx LED Indications	29
3.9. Available Fiber Connector Types	31
3.10. Cellular Modem Modules	32
3.11. HSPA Antenna Requirements	33
3.12. APE Specifications	35
3.13. APE Module LED Indicators	38
4.1. Power Supply Specifications	40
4.2. Form C Contact Relay Specifications	40
4.3. Copper Ethernet Port Specifications	40
4.4. Fast Ethernet (100Mbps) Optical Specifications	41
4.5. SFP Fast Ethernet Transceivers	41
4.6. Fixed Gigabit Transceivers	42
4.7. SFP Gigabit Transceivers	42
4.8. Operating Environment	42
4.9. Mechanical Specifications	42
5.1. IEC 61850-3 EMI Type Tests	43
5.2. IEEE 1613 (C37.90.x) EMI Immunity Type Tests	44
5.3. Environmental Type Tests	44
6.1. Agency Approvals	45

FCC Statement And Cautions

Federal Communications Commission Radio Frequency Interference Statement

This equipment has been tested and found to comply with the limits for a Class A digital device pursuant to Part 15 of the FCC Rules. These limits are designed to provide reasonable protection against harmful interference when the equipment is operated in a commercial environment. This equipment generates, uses and can radiate radio frequency energy and, if not installed and used in accordance with the instruction manual, may cause harmful interference to radio communications. Operation of this equipment in a residential area is likely to cause harmful interference in which case the user will be required to correct the interference at his own expense.



Caution: LASER

This product contains a LASER system and is classified as a CLASS 1 LASER PRODUCT. Use of controls or adjustments or performance of procedures other than those specified herein may result in hazardous radiation exposure.



Caution: Service

This product contains no user-serviceable parts. Attempted service by unauthorized personnel shall render all warranties null and void.

Changes or modifications not expressly approved by RuggedCom Inc. could invalidate specifications, test results, and agency approvals, and void the user's authority to operate the equipment.

Should this device require service, refer to [Chapter 7, Warranty](#) in this guide.



Caution: Physical Access

This product should be installed in a restricted access location where access can only be gained by service personnel or users who have been instructed about the reasons for the restrictions applied to the location and about any precautions that shall be taken; and access is through the use of a tool or lock and key, or other means of security, and is controlled by the authority responsible for the location.

1. Product Overview

1.1. Functional Overview

The RuggedBackbone™ RX1501 is a cost-efficient, rugged layer 3 switch and router. The RX1501's modular and field replaceable platform allows you to select WAN, serial, and Ethernet options, making it ideally suited for electric power utilities, the industrial plant floor, and traffic control systems.

The RX1501 is designed to the RuggedRated™ specification, providing a high level of immunity to electromagnetic interference (EMI) and heavy electrical surges typical of the harsh environments found in many industrial applications. An operating temperature range of -40°C to +85°C (-40°F to +185°F) allows the RX1501 to be placed in almost any location.

1.2. Feature Highlights

Cyber Security Features

- Multi-level passwords
- SSH/SSL encryption
- Enable/disable ports, MAC-based port security
- Port-based network access control (802.1x)
- VLAN (802.1Q) to segregate and secure network traffic
- RADIUS centralized password management
- SNMPv3 encrypted authentication and access security

RuggedRated™ for Reliability in Harsh Environments

- Immunity to EMI and high voltage electrical transients:
 - Zero-Packet-Loss Technology
 - Meets IEEE 1613 (electric utility substations)
 - Exceeds IEC 61850-3 (electric utility substations)
 - Exceeds IEC 61800-3 (variable speed drive systems)
 - Exceeds IEC 61000-6-2 (generic industrial environment)
- -40°C to +85°C operating temperature (no fans)
- Optional conformal coated printed circuit boards
- Failsafe Output Relay: For critical failure or error alarming

Physical Ports

- Field replaceable line modules
- Up to 36 ports 100FX
- Up to 36 ports 10/100TX
- Up to 8 ports Gigabit Ethernet

WAN Port Options

- Up to 4 T1/E1 ports via RJ45 connectors (channelized/unchannelized)
- Up to 2 E1 ports via BNC connectors (channelized/unchannelized)
- Cellular/DDS

Serial Ports

- Fully compliant EIA/TIA RS485, RS422, RS232 serial ports (software selectable) with RJ45 connectors
- Raw socket mode support allows conversion of any serial protocol

Protocols

• **WAN**

- Frame Relay RFC 1490 or RFC 1294
- PPP RFC 1661, 1332, 1321, 1334, PAP, CHAP Authentication
- Multilink PPP RFC 1990
- GOOSE messaging support

• **IP**

- Routing: OSPF, BGP, RIPv1, RIPv2
- VRRP Agent
- Traffic control, NTP Server, IP Multicast Routing
- DHCP Agent (Option 82 Capable)

Frame Relay Support

- ISO and ITU compliant, network certified.
- ANSI T1.617 Annex D, Q.933 or LMI Local Signaling

Management Tools

- Web-based, SSH, CLI management interfaces
- SNMP v1, v2, and v3
- Remote Syslog
- Rich set of diagnostics with logging and alarms
- Loopback diagnostic tests
- Raw and interpreted real-time line traces

Universal Power Supply Options

- Single, removable power supply module
- Single power supply
- Fully integrated power supply (no external adaptor)
- Input voltage ranges: 10-36VDC, 36-72VDC, 88-300VDC, 85-264VAC
- TUV/UL 60950 safety approved to 85°C

Warranty

- 5 Year Warranty

2. RuggedBackbone™ Modules

The RX1501 chassis provides seven module slots . Each slot accommodates a particular type of RuggedCom module. [Figure 2.1, “RX1501 Chassis Slot Assignment”](#) shows the module slots on the RX1501.

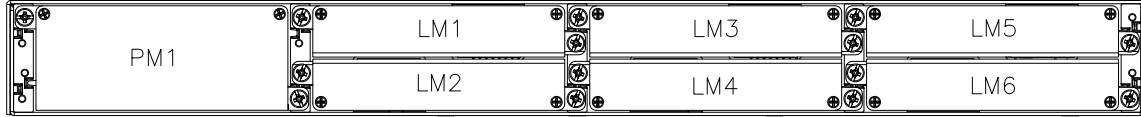

Figure 2.1. RX1501 Chassis Slot Assignment

The RX1501 chassis supports the following modules:

LM1 through LM6

The RX1501 chassis supports up to six line module (LM) cards. For more information on line modules, see [Section 2.2, “Line Modules \(LM\)”](#).

All modules are built to the RuggedRated™ specifications of the RuggedBackbone™ RX1501. Each module type is described in the following sections.



To install a module into the RuggedBackbone™ chassis, align the module guide ribs with the channels on the chassis. Push the module in as far as it will go, being sure to push through the resistance provided by the grounding springs. When properly seated, the module flange will rest on the main chassis frame. Tighten the thumbscrews using finger strength only.

2.1. Front Panel

The RX1501 Front Panel is equipped with an RS232 serial console port for initial management functions, and a locally connected 10/100Base-T Ethernet port for system management out of band from the switch fabric.

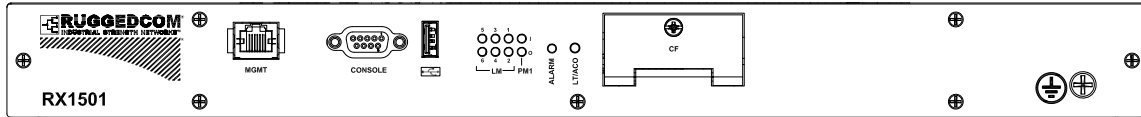

Figure 2.2. Front View - RX1501

Other Front Panel features include:

- Utility USB port.
- Power module indicator LED.
- Line module indicator LEDs.
- Alarm Indicator LED, which indicates system alarm status.
- Lamp Test / Alarm Cutoff (LT/ACO) button.
- Removable 1GB Compact Flash (CF) card, which contains active and fallback installations of the ROX™ operating system, along with the configuration database and other system data.
- Chassis ground connection.

For more information on connecting to the ports on the front panel, see the following topics:

- Serial Console: [Section 3.4, “Serial Console Port”](#)
- Management Ethernet Interface: [Section 3.7, “Copper Ethernet Ports”](#)
- Critical Alarm (Failsafe) Relay Interface: [Section 3.3, “Critical Alarm Wiring”](#)

2.1.1. Module Status LEDs

The front panel module status LEDs provide the following information:

LED	Purpose	Description
PM1	Indicates power supply status.	I = Power supply is receiving input voltage. O = Power supply is providing output voltage to the RX1501.
LM 1 through 6	Indicates the line module status.	Green = OK Orange = Warning alert Red = Configuration error

Table 2.1. Module Status LED Indications

2.2. Line Modules (LM)

The RuggedBackbone™ RX1501 supports six line modules in slots LM1 through LM6 . Several types of line modules may be ordered, depending on the type, speed, and number of Ethernet ports required.

The following illustrations show the typical port configurations and connectors available for RX1501 line modules. For complete information on the available line modules, refer to the RuggedBackbone™ RX1501 data sheet.



Only one T1/E1 module may be used per router.

On the RX1501, 2-port modules can only be inserted in LM1 and LM2.

2.2.1. Ethernet - Copper

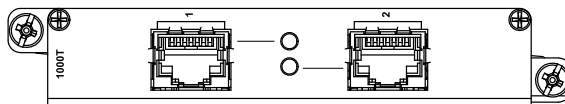

Figure 2.3. CG01: 2 x 10/100/1000TX RJ45

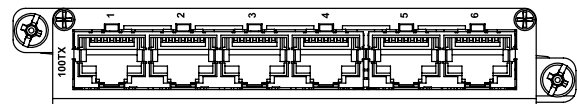

Figure 2.4. 6TX01: 6 x 10/100/1000TX RJ45

2.2.2. Ethernet - Fiber

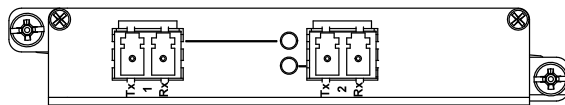

Figure 2.5. FX**/FG**: 2 x 100FX/1000SX/1000LX LC

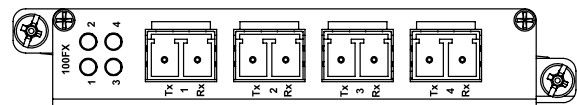

Figure 2.6. 4FX**: 4 x 100FC LC

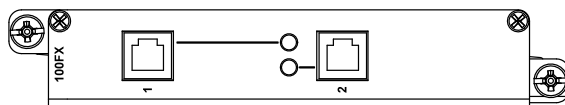

Figure 2.7. FX03: 2 x 100 FX MTRJ

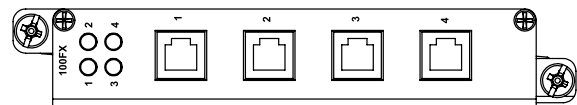

Figure 2.8. 4FX03: 4 x 100FX MTRJ

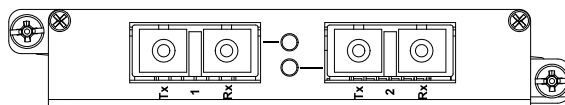

Figure 2.9. FX**: 2 x 100FX SC

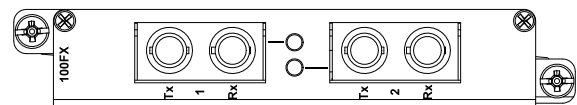

Figure 2.10. FX**: 2 x 100FX ST

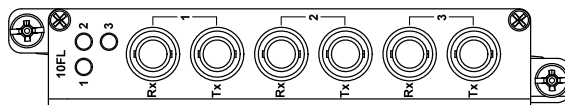

Figure 2.11. 10FL: 3 x 10FL ST

2.2.3. SFP Modular

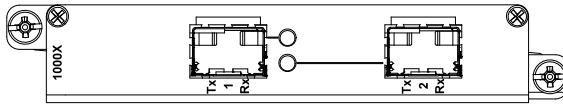

Figure 2.12. FG5+: 2 x 1000LX/1000SX SFP

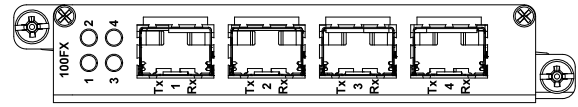

Figure 2.13. FX5+: 4 x 100FX/100LX/100SX SFP

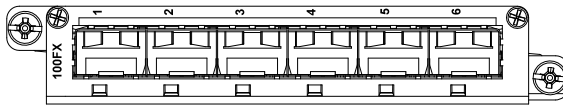

Figure 2.14. 6FX50: 6 x 100FX SFP

2.2.4. WAN

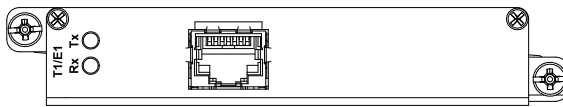

Figure 2.15. TC1: 1 x T1/E1 RJ45

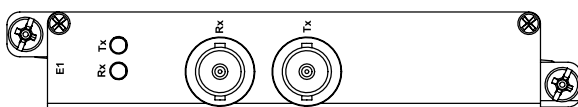

Figure 2.16. E01: 1 x E1 BNC

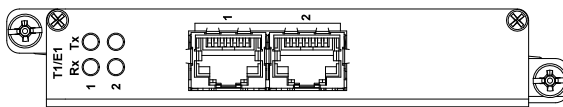

Figure 2.17. TC2: 2 x T1/E1 RJ45

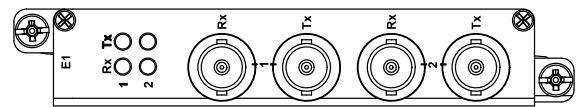

Figure 2.18. E02: 2 x E1 BNC

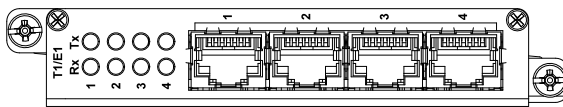

Figure 2.19. TC4: 4 x T1/E1 RJ45

2.2.5. Serial

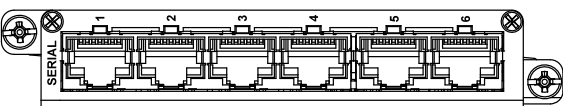

Figure 2.20. 6S01: 6 x Serial RJ45

2.2.6. Cellular Modem

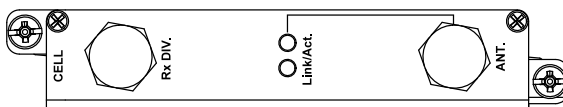

Figure 2.21. W11, W21, W32 Cellular Modem

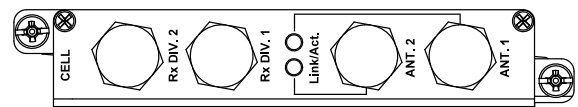

Figure 2.22. W12, W22 Cellular Modem

2.2.7. DDS - Digital Data Services

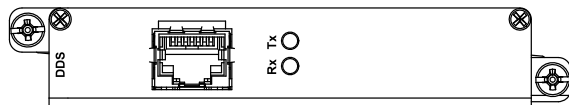

Figure 2.23. D02: 1 x DDS RJ45

2.2.8. APE - Application Processing Engine

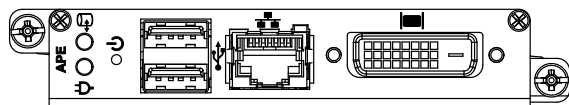

Figure 2.24. APE 1402

2.3. Power Supply

The RX1501 is equipped with a single power module.

A single power module is capable of delivering a maximum of 42W, and accepts either AC or DC power at its input.

Power modules may be ordered with a screw terminal block or with a pluggable terminal block. The screw terminal block features a safety cover which must be removed to make wiring connections, and must be replaced after wiring is complete.

Power modules may be ordered as separate components. Refer to the RX1501 data sheet for complete ordering details.

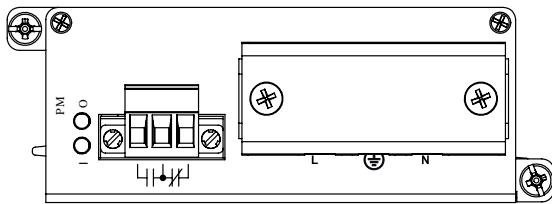

Figure 2.25. Screw terminal block power module: terminal cover in place (HI module shown)

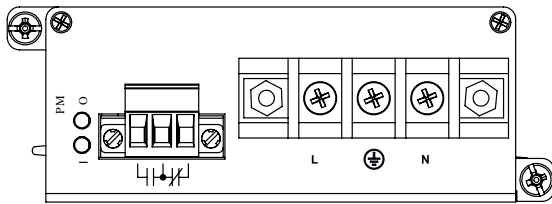

Figure 2.26. Screw terminal block power module: terminal cover removed (HI module shown)

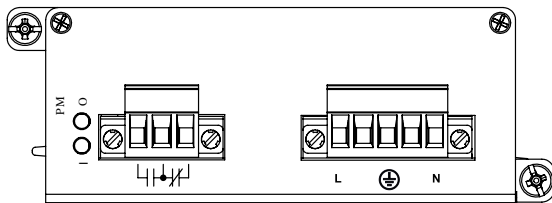

Figure 2.27. Pluggable terminal block power module (HIP module shown)

3. Installation

3.1. Rack Mounting

The RuggedBackbone™ RX1501 mounts to a standard 19" rack. Rack mounting brackets can be installed at the front or rear of the chassis. Placing the connectors at the rear allows all data and power cabling to be installed and connected on the same side of the rack.

Remove the black pan head Phillips screws from the front or rear mounting locations. Position the rack mounting bracket, aligning the holes in the bracket with the screw holes on the chassis. Attach the mounting bracket with the screws from the chassis. Torque all screws to 10 in-lbs.

For high-vibration or seismically active locations, use rack mounting brackets at all four corners of the chassis.

i Due to the heat dissipated in the RX1501 chassis, it is recommended that 1 unit of rack space (1U or 1.75") be left unpopulated and free of equipment above each RX1501 unit to allow for convection airflow. Although forced airflow is not necessary, any increase in airflow will result in a reduction of ambient temperature and will improve long-term reliability of all equipment mounted in the rack.

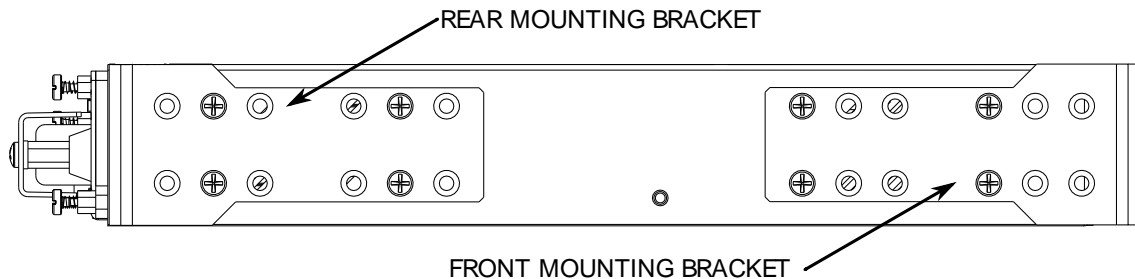

Figure 3.1. Side View of Mounting Brackets

3.1.1. Rack Mounting Dimensions

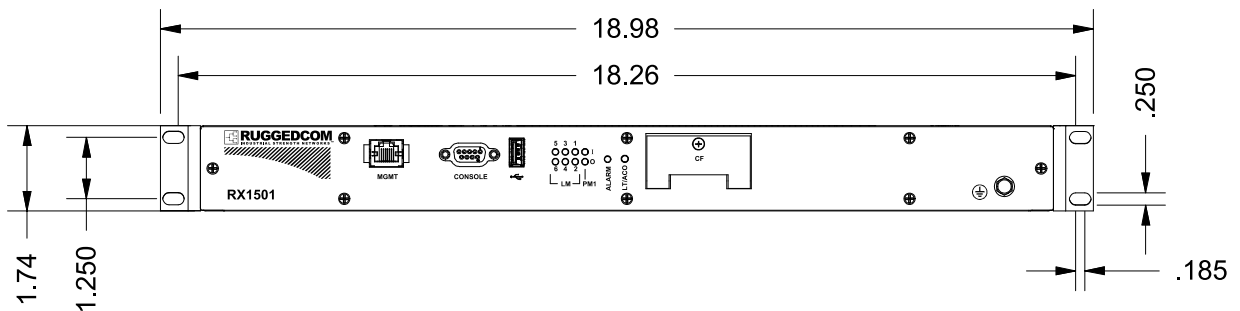

Figure 3.2. RX1501 Rack Mounting Dimensions – Front View

3. Installation

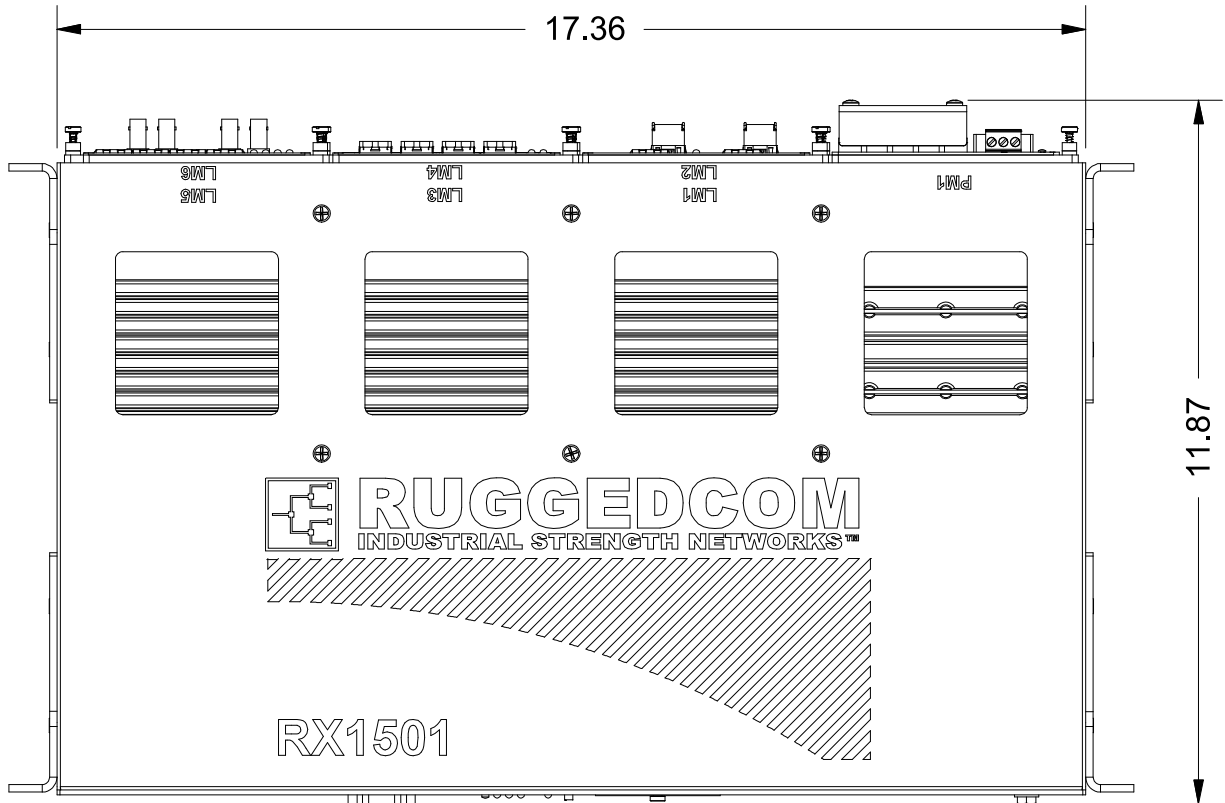

Figure 3.3. RX1501Rack Mounting Dimensions – Top View

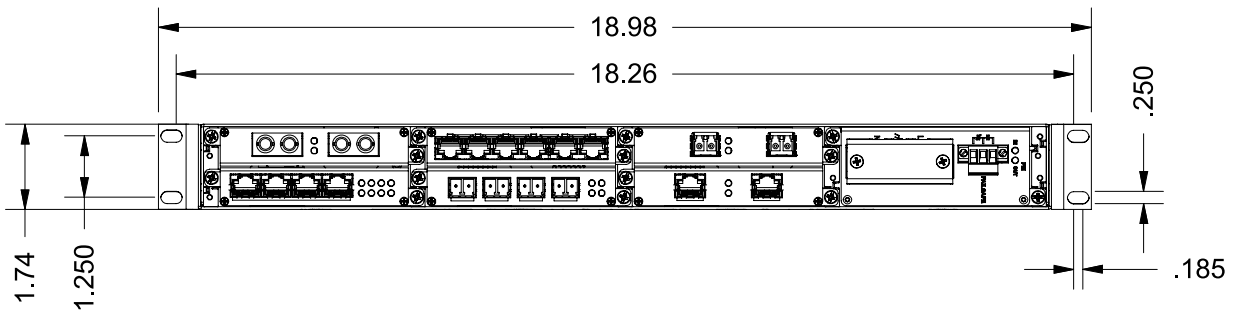
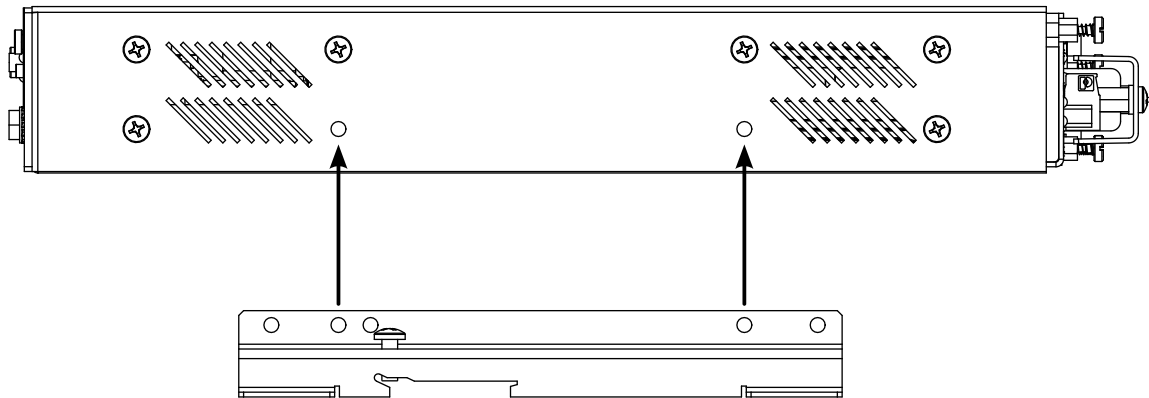

Figure 3.4. RX1501Rack Mounting Dimensions – Rear View

3.1.2. Panel and DIN Rail Mounting

The RuggedBackbone™ RX1501 features optional mounting brackets for panel and DIN rail mounting. The optional brackets attach to both sides of the appliance at the rear of the chassis. For panel mounting, the mounting bracket provides four mounting holes. For DIN rail mounting, the DIN adaptor mounts to a standard 1" DIN rail and is secured with a lock screw on each adaptor.

To attach the mounting brackets, remove the black pan head Phillips screws from side of the appliance. Align the brackets with the threaded holes on the sides of the appliance. Secure the mounting bracket with the screws from the chassis. Torque all screws to 10 in-lbs.



Align Bracket with Threaded Holes and secure Bracket with Screws

Figure 3.5. Installing Panel and DIN Rail Mounting Brackets

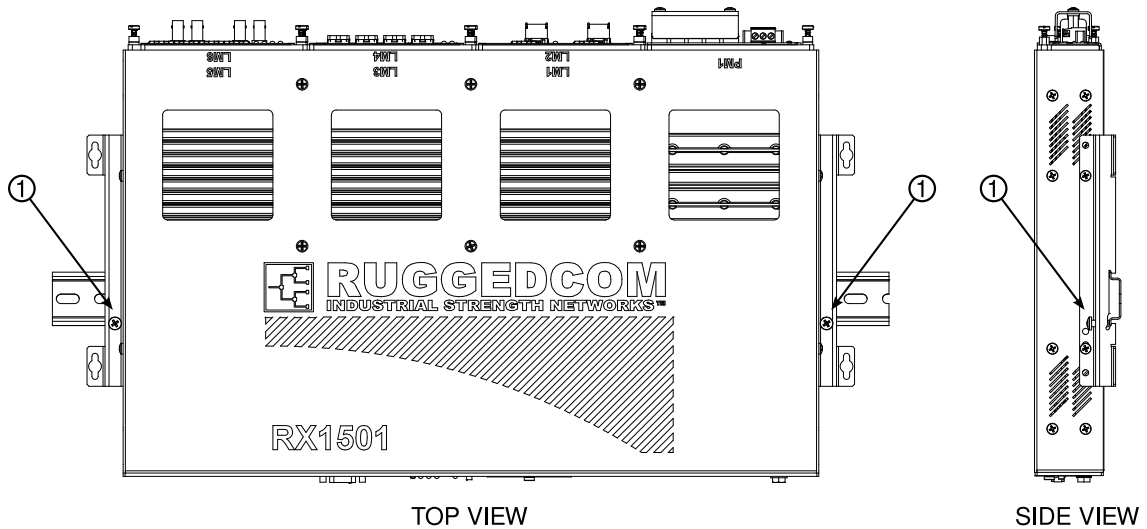

① Secure DIN Rail Locking Screw

Figure 3.6. DIN Rail Mounting

3.1.3. Panel and DIN Rail Mounting Dimensions

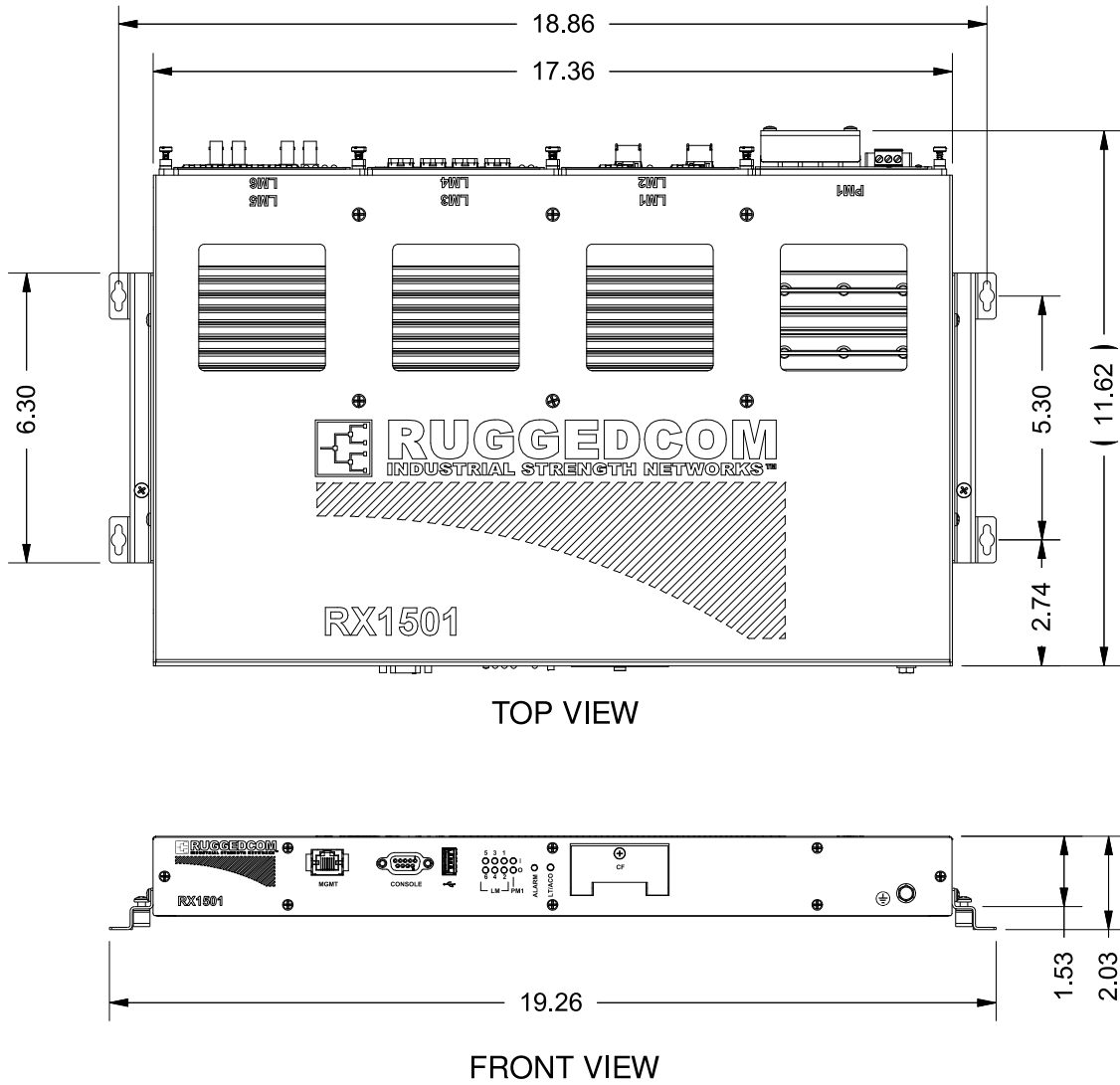



Figure 3.7. Panel and DIN Rail Mounting Dimensions

3.2. Power Supply Wiring and Grounding

The RX1501 supports a single power supply, power module 1 (PM1). Power connections are located on the PM1 module face plate. An optional chassis ground connection is located on the front panel as shown in [Figure 2.2, "Front View - RX1501"](#).

RX1501 products can be equipped with either a Phillips Screw Terminal Block or a Phoenix Plug Terminal Block. The Phillips Screw Terminal Block has Phillips screws with compression plates, allowing either bare wire connections or crimped terminal lugs. We recommend the use of #6 size ring lugs to ensure secure, reliable connections under severe shock or vibration. Both terminal blocks have a safety cover, secured with two Phillips screws, which must be removed to make connections. The safety cover must be re-attached after wiring to ensure personnel safety.

For AC and DC power supply wiring examples, refer to [Section 3.2.4, "AC Power Supply Wiring Example"](#) and [Section 3.2.5, "DC Power Supply Wiring Example"](#).

 *The RX1501 has one (1) power supply installed. Service personnel must isolate all power supplies prior to servicing.*

3.2.1. Connectors for HI and HIP Power Modules

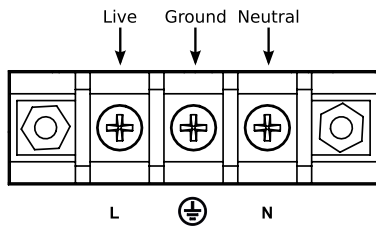

Figure 3.8. Screw Terminal Power Connector for HI Power Module

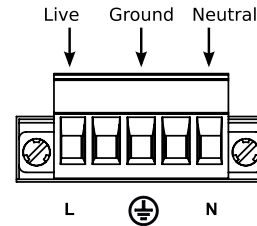

Figure 3.9. Pluggable Phoenix Power Connector for HIP Power Module

3.2.2. Connectors for 24, 24P, 48, and 48P Power Modules

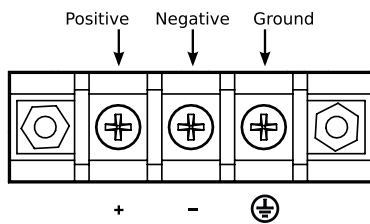

Figure 3.10. Screw Terminal Power Connector for 24 and 48 Power Modules

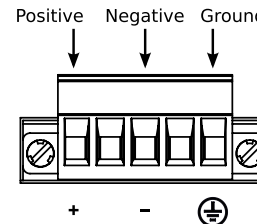

Figure 3.11. Pluggable Phoenix Power Connector for 24P and 48P Power Modules

3.2.3. Chassis Ground Connection

The RX1501 chassis ground connection, shown in Figure 3.12, “Chassis Ground Connection”, uses a #10-32 screw. It is recommended to terminate the ground connection in a #10 ring lug. Torque on the chassis ground connection should not exceed 30 in-lbs (3.4 Nm).

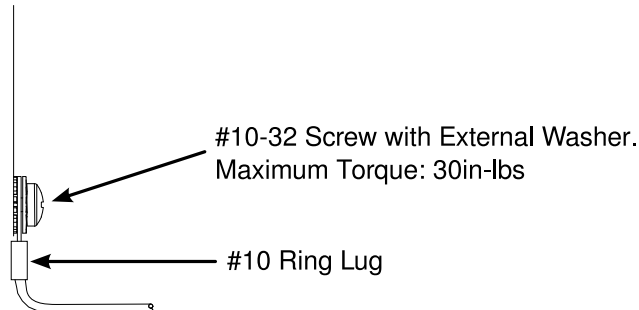

Figure 3.12. Chassis Ground Connection

3.2.4. AC Power Supply Wiring Example

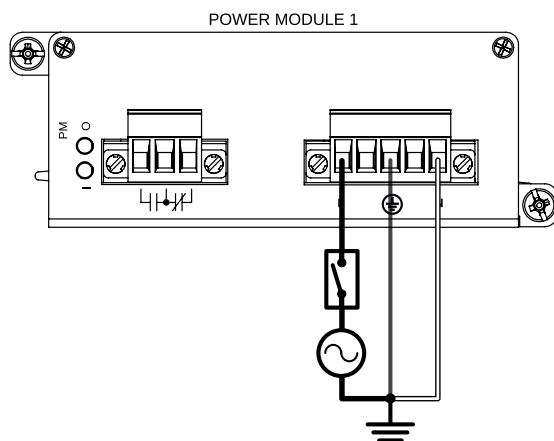

Figure 3.13. Wiring for Single AC Power Supply (HIP module shown)



- For 125/230VAC rated equipment, a appropriately rated AC circuit breaker must be installed.
- It is recommended to provide a separate circuit breaker for each power supply module.
- Equipment must be installed according to applicable local wiring codes.

3.2.5. DC Power Supply Wiring Example

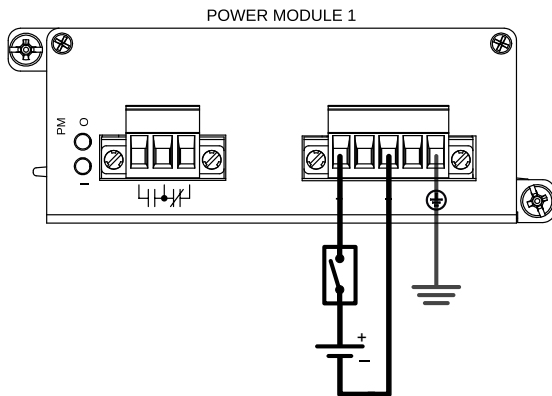

Figure 3.14. Wiring for Single DC Power Supply (24P or 48P module shown)



- For 125/230VAC rated equipment, a appropriately rated AC circuit breaker must be installed.
- It is recommended to provide a separate circuit breaker for each power supply module.
- Equipment must be installed according to applicable local wiring codes.

3.3. Critical Alarm Wiring

The Critical Alarm output relay signals critical error conditions that may occur on the RuggedBackbone™ RX1501. The contacts are energized upon power-up of the unit and remain energized unless a critical alarm condition is detected. Relay connections are shown in the [Critical Alarm Relay Connector](#) diagram. You can configure control of the relay output through the ROX™ user interface.

A common application for this output is to signal an alarm in case of a power failure.

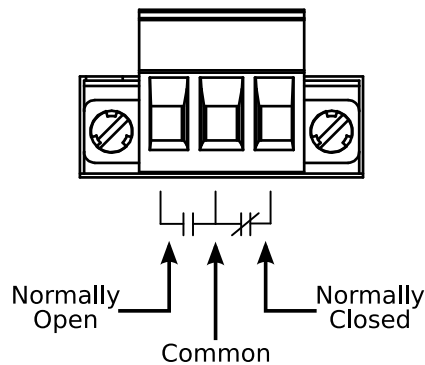

Figure 3.15. Critical Alarm Relay Connector

3.4. Serial Console Port

The serial console port on the front panel provides access to the boot-time control and configuration menu interface, and a console interface to the ROX™ operating system.

The serial ports implement RS232 DCE on a female DB9 connector. Serial settings are: 57600 bps, 8 bits, No parity, 1 stop bit. See the illustration and table below for pin configuration and assignment.

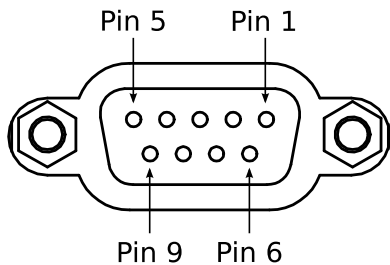

Figure 3.16. DB9 Serial Console Port

DB9 Pin	Signal Function
1	NC
2	TX
3	RX
4	NC
5	GND
6	NC
7	NC
8	NC
9	NC

Table 3.1. DB9 Serial Console Pinout

3.5. WAN Ports: RJ45

The RX1501 supports T1/E1 WAN ports, to interface to standard T1 or E1 telecommunication infrastructure. Carefully note the orientation of the RJ45 receptacle when inserting or removing cabling. See the illustration and table below for pin configuration and assignment.

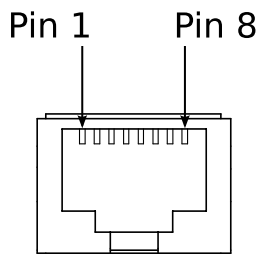

Figure 3.17. RJ45 T1/E1 Pin Configuration

T1/E1 pinout	
Pin	Description
1	RRING
2	RTIP
3	NC
4	TRING
5	TTIP
6	NC
7	NC
8	NC

Table 3.2. RJ45 T1/E1 Pin Assignment

3.6. WAN Ports: BNC

The RX1501 supports optional E1 WAN ports with BNC connectors. The Tx and Rx connections are labelled on the line module. See the illustration below for the connection configuration.

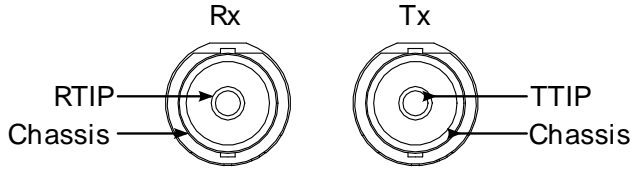

Figure 3.18. RJ45 T1/E1 Pin Configuration

3.7. Copper Ethernet Ports

The RuggedBackbone™ RX1501 can be ordered with up to 36 10/100Base-TX ports that allow connection to standard CAT-5 UTP cable with RJ45 male connectors. All copper Ethernet ports feature auto-negotiation, auto-polarity, and auto-crossover functions. The female RJ45 connector can accept and take advantage of screened (commonly known as “shielded”) cabling.

3.7.1. RJ45 Twisted-Pair Copper Ports

Female RJ45 connectors are available on LMs that support 10/100Base-T and on LMs and SMs that support 10/100/1000Base-T Ethernet. See the illustration and table below for pin configuration and assignment.

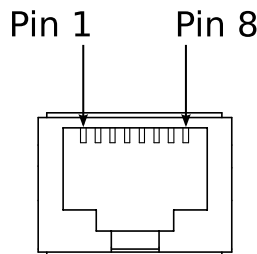

Figure 3.19. RJ45 Ethernet Pin Configuration

RJ45 Pin	10/100Base-Tx	10/100/1000Base-Tx
1	RX+	A+
2	RX-	A-
3	TX+	B+
4	NC	C+
5	NC	C-
6	TX-	B-
7	NC	D+
8	NC	D-

Table 3.3. RJ45 Ethernet Pin Assignment

3.7.2. Gigabit Ethernet 1000Base-TX Cabling Recommendations

The IEEE 802.3ab Gigabit Ethernet standard defines 1000 Mbit/s Ethernet communications over distances of up to 100 meters using 4 pairs of CAT-5 (or higher) balanced, unshielded twisted-pair cabling. For wiring guidelines, system designers and integrators should refer to the Telecommunications Industry Association (TIA) TIA/EIA-568-A wiring standard for minimum cabling performance specifications required for proper Gigabit Ethernet operation. To ensure reliable, error-free data communications, new and pre-existing communication paths should be verified for TIA/EIA-568-A compliance. The table: [Cabling Categories and 1000Base-TX Compliance](#) summarizes the relevant cabling standards as they apply to 100Base-TX connections.

Cabling Category	1000Base-TX Compliant	Required Action
< 5	No	New wiring infrastructure required.
5	Yes	Verify TIA/EIA-568-A compliance.
5e	Yes	No action required. New installations should be designed with Category 5e or higher.
6	Yes	No action required.
> 6	Yes	Connector and wiring standards to be determined.

Table 3.4. Cabling Categories and 1000Base-TX Compliance

Follow these recommendations for copper data cabling in high electrical noise environments:

- Data cable lengths should be as short as possible, ideally limited to 10' (3m) in length. Copper data cables should not be used for inter-building communications.
- Power and data cables should not be run in parallel for long distances, and should be installed in separate conduits. Power and data cables should intersect at 90° angles when necessary to reduce inductive coupling.
- Optionally, shielded/screened cabling can be used. The cable shield should be grounded at one single point to avoid the generation of ground loops.

3.7.3. Transient Suppression

All copper Ethernet ports on RuggedCom products include transient suppression circuitry to protect against damage from electrical transients and to ensure conformance to IEC 61850-3 and IEEE 1613 Class 1. This means that during a transient electrical event, it is possible for communications errors or interruptions to occur, but recovery is automatic.



RuggedCom does not recommend the use of copper cabling of any length for critical, real-time, substation automation applications.

RuggedCom also recommends against the use of copper Ethernet connections to interface to devices in the field across distances which could produce high levels of ground potential rise (that is, greater than 2500V), during line-to-ground fault conditions.

3.8. Serial Ports: RJ45

The RX1501 supports serial port line modules with RJ45 connections. On power-up, all serial ports default to RS485 mode. Each port can be individually set to RS232, RS485, or RS422 mode via software.

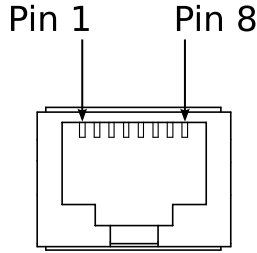

Figure 3.20. RJ45 Serial Pin Configuration

Pin	RS232 Mode	RS485 Mode	RS422 Mode
1			RX-
2	Reserved		
3	COM (Isolated GND)		
4	COM (Isolated GND)		
5	RX		RX+
6	TX	TX/RX +	TX +
7	CTS		
8	RTS	TX/RX -	TX -
Shield	Chassis GND		

Table 3.5. RJ45 RS232/RS485/RS422 Serial Pin Assignment



Pin 2 is reserved for future IRIG-B output. Do not connect Pin 2 at this time; doing so may cause hardware damage. Pins 7 and 8 are connected internally. No internal termination is provided. In RS232 mode, these pins enter a high impedance state. A DTE that asserts RTS will see CTS asserted, but hardware flow control is not performed on the port.

3.9. DDS Ports: RJ45

The RX1501 supports DDS port line modules with RJ45 connections. The 56 kbps DDS port is compatible with Bellcore standards. Each DDS module features a single 56/64 kbps DDS line interface with a standard RJ45 receptacle.

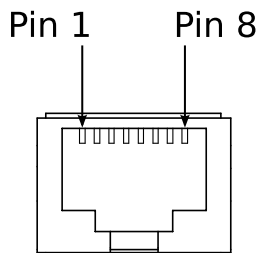

Figure 3.21. RJ45 DDS Pin Configuration

RJ45 Pin	Description
1	R1: Transmit data to network (Ring 1)
2	T1: Transmit data to network (Tip 1)
3	NC
4	NC
5	NC
6	NC
7	T: Receive data from network (Tip)
8	R: Receive data from network (Ring)

Table 3.6. RJ45 DDS Pin Assignment

3.10. DDS Rx and Tx LED Indications

The DDS module features Rx and Tx LED indicators that display transmit and receive status.

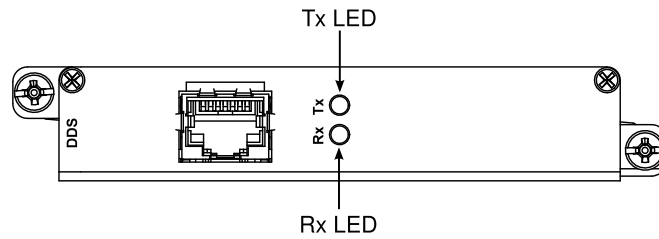

Figure 3.22. DDS Module Rx and Tx LED Indicators

The following tables describe the DDS module Rx and Tx LED status indications:

Rx LED Color	Status
GREEN	Frame sync detected and signal OK.
YELLOW	Signal OK, but no frame sync.
RED	Loss of signal.
OFF	The interface is not enabled.

Table 3.7. DDS Rx LED Indications

Tx LED Color	Status
GREEN	The interface is enabled and remote device has no errors.
YELLOW	The interface is in loopback mode.
RED	Loss of signal or receiving any of OOS, UNM, or UMC codes: the remote device is out of service or has problems with the signal.
OFF	The interface is not enabled.

Table 3.8. DDS Tx LED Indications

3.11. SFP Optics – Installation, removal, and precautions

The RX1501 can be ordered with SFP (Small Form-factor Pluggable) pluggable optics modules. SFP modules can be safely inserted and removed while the chassis is powered and operating. When inserting or removing optics, observe the following precautions:

- Ensure that dust caps are mounted on SFP cages at all times, unless you are in the process of inserting or removing an SFP module. The dust caps prevent the accumulation of residue or particles that might inhibit proper operation.
- Ensure that you have properly discharged any possible electrostatic build-up to prevent electrostatic discharges (ESD). This can be accomplished by proper grounding through an ESD wrist strap, or by touching earth or chassis ground before installing or removing optical modules. ESD can damage or shorten the life of optical modules when they are not plugged into a chassis.
- Ensure that SFP optical modules are always stored in an ESD-safe bag or other suitable ESD-safe environment. Keep SFP modules free from moisture and store them at the proper temperature (-40°C to +85°C).
- Disconnect all cables from the SFP module before inserting or removing the module.
- Use only components certified by RuggedCom Inc. with RuggedCom products. Damage can occur to optics and product if compatibility and reliability have not been properly assessed.

3.11.1. Module Insertion – SFP

Special attention must be paid to the orientation of SFP modules upon installation in the RX1501 chassis. The figure below shows the proper orientation of SFP modules installed in both upper and lower line modules. SFP modules on the upper row must be inserted top-side up. SFP modules on the lower row must be inserted top-side down. SFP modules should be inserted with the bail latch in the locked position.

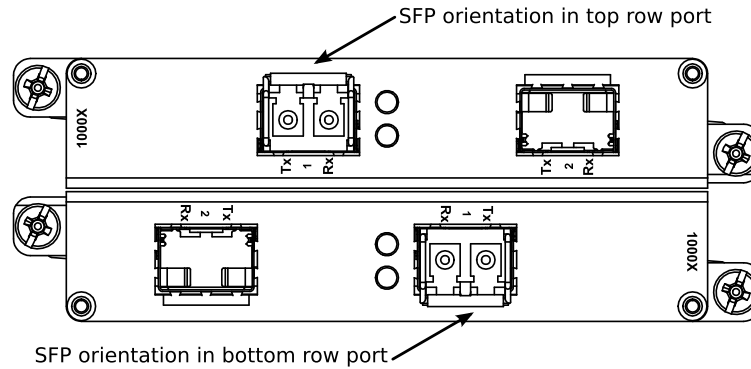

Figure 3.23. SFP module orientation

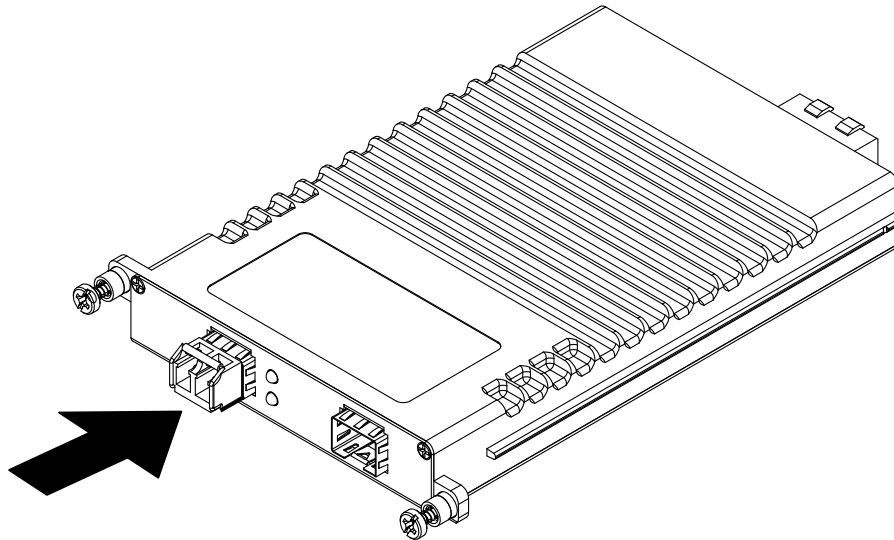

Figure 3.24. SFP module insertion

SFP modules should slide gently into their ports and should lock in place when fully inserted. Dust covers should be in place when installing the modules, and should always be in place when cables are not connected.

3.11.2. SFP Module Removal

To remove the SFP module, disconnect any cables and replace the dust cover to protect the optics. Extend the bail latch found on the top of the module. Grasp the bail latch and gently pull outwards to unlock and remove the module.

Immediately after removal, store the SFP module in an ESD-safe environment.

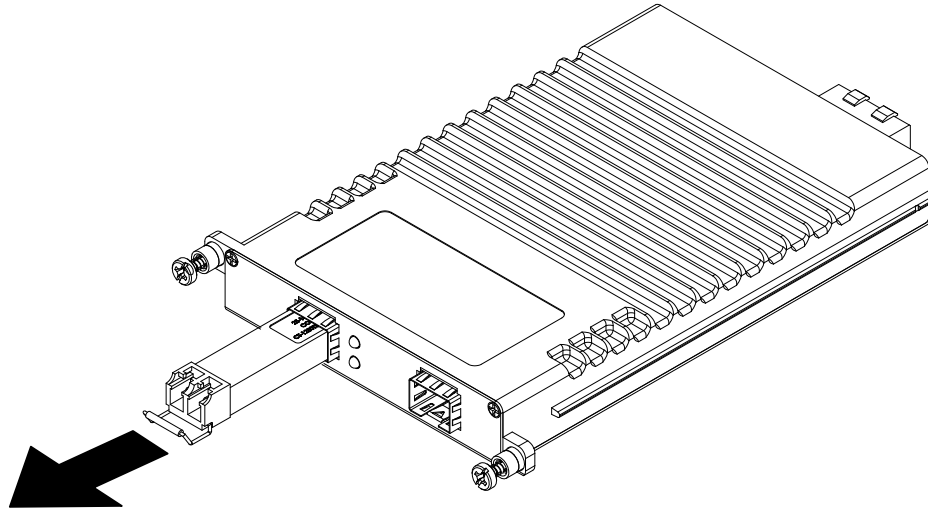

Figure 3.25. SFP module removal

3.12. Fiber Ethernet Ports

Depending on the order code of the product, the RuggedBackbone™ RX1501 can be equipped with several different types of fiber optic ports. The Transmit (TX) and Receive (RX) connections of each port must be properly connected and matched for proper link establishment and operation. The drawings in the following figures show a side and top view of each supported fiber optic connector type to assist in identifying the proper cable connection orientation.

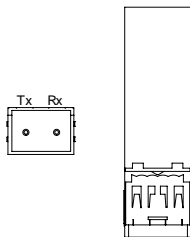

Figure 3.26. LC

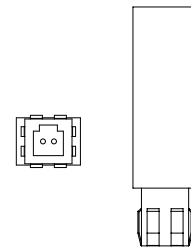

Figure 3.27. MTRJ

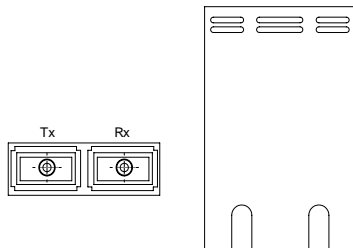

Figure 3.28. SC

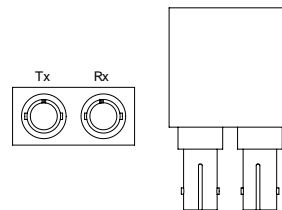

Figure 3.29. ST

Table 3.9. Available Fiber Connector Types

3.13. Cellular Modems

The RX1501 can be equipped with cellular modem modules for operation on GSM, EDGE, HSPA+, or CDMA networks. The cellular modems feature 50 Ω SMA antenna connectors on the front plate of each module. The following cellular modem modules are available:

Module Order Code	Description
W11	1 Port Cell Modem GSM,EDGE,HSPA+
W12	2 Port Cell Modem GSM,EDGE,HSPA+
W21	1 Port Cell Modem EVDO Rev.A Verizon Wireless
W22	2 Port Cell Modem EVDO Rev.A Verizon Wireless
W32	1 Port Cell Modem GSM,EDGE,HSPA+, 1 Port Cell Modem EVDO Rev.A Verizon Wireless

Table 3.10. Cellular Modem Modules

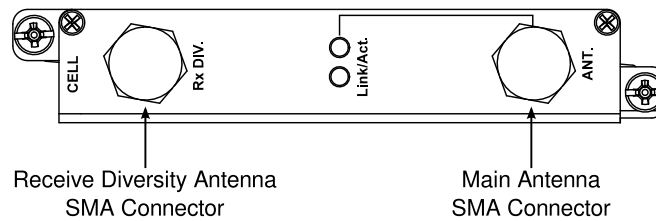

Figure 3.30. Single Port Cellular Modem: Antenna Connections

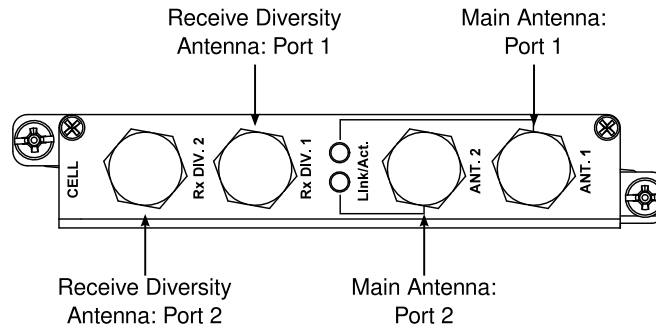

Figure 3.31. Dual Port Cellular Modem: Antenna Connections



If two or more antennas are to be installed, the antennas must be separated by a minimum distance of 20 cm (7.9").

3.13.1. GSM, EDGE, HSPA+ Cellular Modem Card

The HSPA option is available for use on various GSM based networks. This option supports GSM, GPRS, EDGE, UMTS and WCDMA/HSDPA/HSUPA. The Main antenna and Receive Diversity antenna connections are made to the 50 Ω SMA connectors located on either side of the front faceplate.

Supported frequency bands are given in the following table. For safe operation of the device, ensure that the maximum antenna gain is not exceeded.

Band	Frequency Range				RX Diversity Support	Maximum Allowable Gain (dBi)
	Tx (MHz)	VSWR	Rx (MHz)	VSWR		
Band I WCDMA 2100	1920-1980	<2.5:1	2110-2170	<3.5:1	Y	4
Band II WCDMA 1900	1850-1910	<2.5:1	1930-1990	<2.5:1	Y	4
Band VIII WCDMA 900	880-915	<2.5:1	925-960	<3.5:1	Y	5
Band V WCDMA 850	824-849	<2.5:1	869-894	<3.5:1	Y	5
Band VI WCDMA 800	830-840	<2.5:1	875-885	<3.5:1	Y	5
GSM 850	824-849	<2.5:1	869-894	<3.5:1		5
EGSM 900	880-915	<2.5:1	925-960	<3.5:1		5
GSM 1800	1710-1785	<2.5:1	1805-1880	<3.5:1		4
GSM 1900	1850-1910	<2.5:1	1930-1990	<2.5:1		4

Table 3.11. HSPA Antenna Requirements

3.13.2. Installing SIM Cards for GSM, EDGE, HSPA+ Cellular Modems

i *Be sure to take appropriate anti-static precautions before opening the cellular modem module.*

1. Remove the module from the RX1501.
2. On the smooth side of the module, remove the four screws and remove the back of the module.

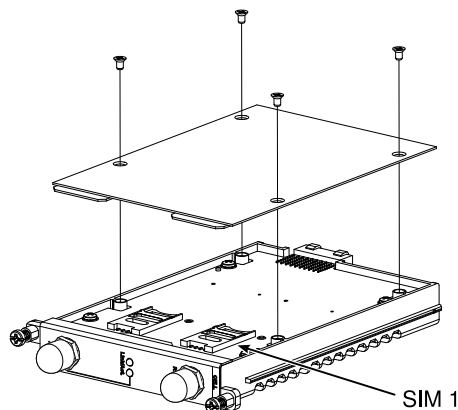

Figure 3.32. Cellular Modem Module Assembly: W11 and W32 Single Antenna Modules

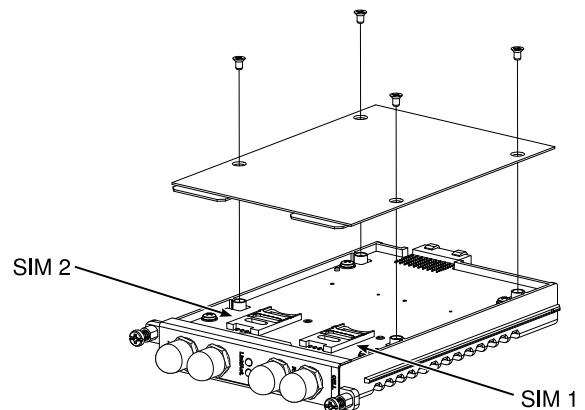

Figure 3.33. Cellular Modem Module Assembly: W12 Dual Antenna Modules

3. Installation

3. Note the location of the SIM card cages. For modules W11 and W32, install the SIM card in **SIM 1**. For module W22, install a SIM card in both **SIM 1** and **SIM 2**.
4. Top open a SIM card cage, slide the silver catch down towards the antenna connector end of the module and flip the cage open.
5. Hold the SIM card at its notched end, with its connectors facing down, and insert the SIM card into the cage.
6. Flip the cage down and slide the silver catch up away from the antenna connector end of the module.
7. Replace the back of the module and secure the back of the module with the four screws removed earlier.
8. Re-install the module in the RX1501.

3.14. APE: Application Processing Engine

3.14.1. APE Overview

The APE (Application Processing Engine) is an x86-based computer designed to occupy a single line module slot on the RX1501. The APE can host any x86-based operating system capable of running on a computer with similar specifications, and features a Gigabit Ethernet connection on the module faceplate. You can use the APE for a variety of functions, such as network monitoring, specialized applications, DNS applications, and more.

Feature	Description
Processor	Intel Atom E660T 1.3 GHz
RAM	2 GB DDR2
Disk	8 GB SATA, solid state
Network	1 x RJ45 Gigabit Ethernet interface, faceplate connector 1 x Gigabit Ethernet interface, connected to internal RX1501 switch
USB	2 x USB 2.0. Maximum USB device power consumption, through single port or combined through both ports: 250 mA at 5 V.
Video	DVI-D
LED Indicators	<ul style="list-style-type: none"> Power Disk Activity
Controls	Momentary contact reset button
Operating System	Supports any x86-compatible operating system compatible with hardware specifications. For a list of tested and confirmed operating systems, see Section 3.14.2, "Supported Operating Systems" .

Table 3.12. APE Specifications

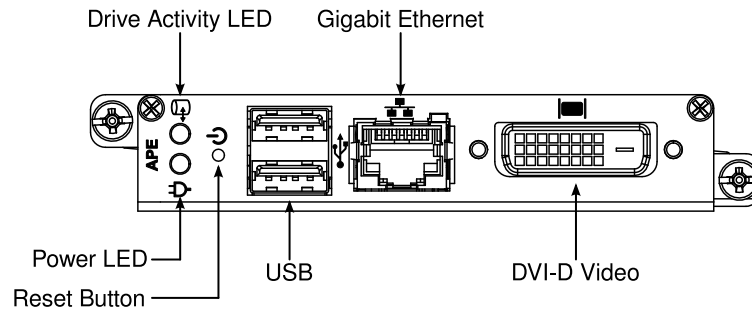

Figure 3.34. APE Faceplate and Ports

3.14.2. Supported Operating Systems

The APE supports any x86-compatible operating system. The following operating systems have been tested and confirmed to work with the APE module:

- Microsoft Windows Embedded Standard 7
- Debian GNU/Linux 6
- Ubuntu 11.04
- Linux Mint 10
- OpenSuse 11.4

3.14.3. Secondary Network Interface

In addition to the gigabit Ethernet interface on the faceplate, the APE features a gigabit Ethernet interface connecting to a port on the RX1501 chassis. The interface can be used by the operating system running on the APE as a normal network interface. The port can be configured from ROX™. Typical port parameters, such as speed, duplex, vlans, and more, can be configured. From the perspective of the RX1501, the port is just switch port where a device is connected.

Figure 3.35, “APE Chassis Network Connection” shows how the APE and the RX1501 are connected. The APE module can have connectivity to devices or networks connected to regular ports on the RX1500.

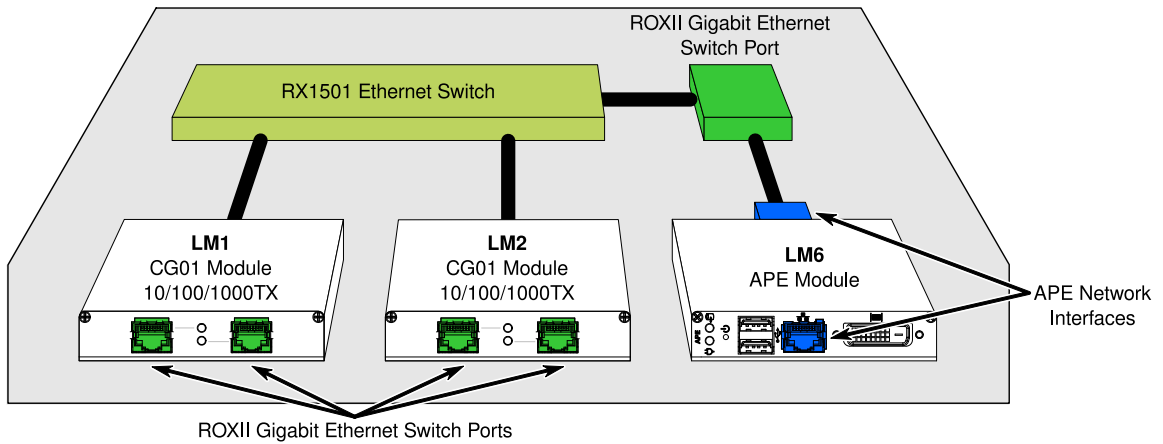

Figure 3.35. APE Chassis Network Connection

3.14.3.1. Placing the APE in a VLAN

The port connecting the APE to the RX1501 is a normal switch port. The port PVID can be changed through ROX™ as can be done with any other switch port. For example, if the APE is Line Module 2 (LM2), then setting the lm2/1 pvid parameter to 10 places the APE secondary network interface connection on VLAN 10.

3.14.4. Installing an Operating System



We recommend that the operating system be installed and configured by users with experience in installing and administering the chosen operating system.

To install an operating system on the APE, you need the following items:

- DVI-D monitor.
- Keyboard with USB connector.
- Bootable USB flash drive or USB external CD/DVD drive with your operating system installation package.



When using an external drive that is powered through the USB port, ensure that the total power consumption through both USB ports does not exceed 250 mA at 5V.

To connect additional USB devices, such as a mouse, you can attach a USB hub to the APE. Again, ensure that the total power consumption through both USB ports does not exceed 250 mA at 5V.

Procedure 3.1. To install an operating system:

1. Ensure that the APE module is inserted properly into the line module slot and that the RX1501 is powered up. The APE module power LED should be ON and orange.
2. Connect your monitor to the DVI-D connector, connect your keyboard to a USB port, and connect your bootable USB device to a USB port.

If your operating system installation package requires a network connection, connect a network cable to the Ethernet port. Connect the other end of the cable to a functioning network port.

3. With a pin or small screwdriver, press and release the APE reset button.
4. After the APE boots, press the **F2** key. The BIOS screen appears.
5. Navigate to the **Boot** menu. Move the USB device to the first boot priority.



Your bootable USB device must be connected to the APE for you to be able to set the device's boot priority.

6. Navigate to the **Exit** menu and select **Exit Saving Changes**. The APE restarts and boots from the connected USB device.
7. Follow the prompts and instructions from your operating system installation package. Detailed installation instructions are beyond the scope of this guide. For detailed instructions on installing your operating system, refer to the operating system documentation.
8. After installing the operating system, you may need to change the boot priority back to the APE's internal drive. Reboot the APE and press **F2** as the module reboots. Navigate to the **Boot** menu and move the internal drive to the first boot priority. Navigate to the **Exit** menu and select **Exit Saving Changes**. The APE restarts and boots from the internal drive.



It is also possible to run a live operating system from the USB device itself. However, this may result in slower overall performance of the operating system.

3.14.5. The APE BIOS

The APE module features a BIOS with functionality similar to that of a typical PC. You can configure the following BIOS settings:

- System Time
- Processor Options
- Boot Options
- Security Options

For most purposes, these options are used sparingly unless there is a specific hardware or software requirement that requires a change. The most commonly changed options are the boot options, as the USB ports need to be made bootable to install an operating system.

To display the BIOS menus, press **F2** while powering on the APE. To display BIOS help, press **F1** and follow the instructions at the bottom of the screen.

3.14.6. Resetting the Module

Whenever possible, shut down and reboot the APE from the operating system instead of performing a hard reset with the reset button. This helps to ensure graceful shutdowns and data integrity. If absolutely required, you can perform a hard reset with the reset button on the APE faceplate.

The reset button is recessed from the front surface of the faceplate. Use a pin or small screwdriver to reach the button.

To reset the APE, depress and hold the reset button until the power LED turns orange. Then, release and push the reset button again. The power LED turns green as the module reboots.

3.14.7. LED Indicators



LED Indicator	LED Color and State	Description
Power LED	 Green, steady	APE module is on and functioning correctly.
Power LED	 Orange, steady	APE module is not receiving enough power or is shut down.
Disk LED	 Green, steady or blinking.	Indicates read and write activity to the solid state drive.
Ethernet Port LED	 Green, steady or blinking.	Indicates incoming and outgoing network activity.

Table 3.13. APE Module LED Indicators

3.14.8. FAQs

Q: How do I use a CD or DVD to install an operating system on the APE module?

A: Connect an external CD/DVD drive to one of the APE USB ports. If the external drive is powered through the USB port, ensure that it does not exceed the USB port power limitations (250 mA at 5 V), or use a drive that has an external power supply.

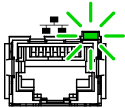
Q: How do I install Windows from a USB flash drive?

A: There are many articles on the Internet explaining how to do this. We recommended selecting a method that uses the least amount of third-party software to create the bootable USB drive.

Q: Can I shutdown or power-up the APE module from ROX™?

A: Not currently. In ROX™ version 2.2, the APE is isolated from ROX™ control. ROX™ can identify the type of module present in the RX1501 line module slot, and can monitor temperature information for the APE module.

Q: Can I connect to the operating system running on the APE from one of the ports on the other slots?

A: Yes. In ROX™, assign **lm{APE_slot}/1**, where **{APE_slot}** is the line module slot where the APE is installed, to the VLAN on which connectivity is expected. The APE should be reachable from any device belonging to the same VLAN.

If you want the APE be routable, log in to the operating system on the APE and set the secondary interface gateway to the IP address of the ROX™ VLAN.

Q: Can I use the APE module as a DHCP server or a DNS server?

A: Yes. The APE module supports any x86-compatible operating system and the services offered by the system.

4. Technical Specifications

4.1. Power Supply Specifications

Power Supply Type	Input Range		Internal Fuse Rating	Max. Power Consumption ^a	Max Power Output	Connections
	Min	Max				
HI	88 VDC	300 VDC	2A(T) ^b	52W Max	42W	Screw terminal block
	85 VAC	264 VAC				
HIP	88 VDC	300 VDC	2A(T) ^b	52W Max	42W	Pluggable terminal block
	85 VAC	264 VAC				
24	10 VDC	36 VDC	2A(T) ^b	52W Max	42W	Screw terminal block
24P	10 VDC	36 VDC	2A(T) ^b	52W Max	42W	Pluggable terminal block
48	36 VDC	72 VDC	2A(T) ^b	52W Max	42W	Screw terminal block
48P	36 VDC	72 VDC	2A(T) ^b	52W Max	42W	Pluggable terminal block

^a Power consumption varies based on configuration.

^b (T) denotes time-delay fuse.

Table 4.1. Power Supply Specifications

4.2. Critical Alarm Relay Specifications

Voltage	Current
30VDC	5A
250VAC	6.25A

Table 4.2. Form C Contact Relay Specifications

4.3. Copper Ethernet Port Specifications

The RX1501 can be ordered with several different modules which contain 10/100Tx or 10/100/1000Tx Ethernet ports. All copper Ethernet ports have the following specifications:

Parameter	Specification	Notes
Speed	10/100 or 10/100/1000 Mbps	Auto-negotiating
Duplex	FDX / HDX	Auto-negotiating
Cable-Type	> Category 5	Shielded/Unshielded
Wiring Standard	TIA/EIA T568A/B	Auto-Crossover, Auto-Polarity
Max Distance	100 m	
Connector	RJ45	
Isolation	1.5kV	RMS 1-minute

Table 4.3. Copper Ethernet Port Specifications

4.4. Fiber Ethernet Port Specifications

The following sections detail fiber optic specifications for ports that can be ordered with the modules on a RuggedBackbone™ RX1501. The user determines the type of optics at time of ordering, and can determine the modules installed on a particular unit by reading the factory data file via the ROX™ user interface. [Section 4.4.1, “Fast Ethernet \(100Mbps\) Optical Specifications”](#) and [Section 4.4.2, “Gigabit Ethernet \(1Gbps\) Optical Specifications”](#) list the specifications of the optical transceivers used in the fiber Ethernet modules available for the RX1501. The specifications are organized by order code. Module order codes are contained within each unit when it is assembled and configured at the factory. Consult the RuggedCom ROX™ User Guide for help in obtaining the factory configuration data.

4.4.1. Fast Ethernet (100Mbps) Optical Specifications

Fixed Fast Ethernet Transceivers

Order Code	Mode	Connector Type	Cable Type (μm)	Tx λ (typ.) (nm)	Tx min. (dBm)	Tx max. (dBm)	Rx Sensitivity (dBm)	Rx Saturation (dBm)	Distance (typ.) (km)	Power Budget (dB)
FX01	MM	ST	62.5/125	1300	-19	-14	-31	-14	2	12
			50/125		-22.5					8.5
FX02	MM	SC	62.5/125	1300	-19	-14	-31	-14	2	12
			50/125		-22.5					8.5
FX11 and 4FX11	MM	LC	9/125	1300	-19	-14	-32	-14	2	13
FX03 and 4FX03	MM	MTRJ	62.5/125	1300	-19	-14	-31	-14	2	12
			50/125		-22.5					8.5
FX04	SM	ST	9/125	1300	-15	-8	-32	-3	20	17
FX05	SM	SC	9/125	1300	-15	-8	-31	-7	20	16
FX06 and 4FX06	SM	LC	9/125	1300	-15	-8	-34	-7	20	19
FX07	SM	SC	9/125	1300	-5	0	-34	-3	50	29
FX08 and 4FX08	SM	LC	9/125	1300	-5	0	-35	3	50	30
FX09	SM	SC	9/125	1300	0	5	-37	0	90	37
FX10 and 4FX10	SM	LC	9/125	1300	0	5	-37	0	90	37

Table 4.4. Fast Ethernet (100Mbps) Optical Specifications

SFP Fast Ethernet Transceivers

Order Code	Mode	Connector Type	Cable Type (μm)	Tx λ (typ.) (nm)	Tx min (dBm)	Tx max (dBm)	Rx Sensitivity (dBm)	Rx Saturation (dBm)	Distance (typ.) (km)	Power Budget (dB)
FX51	MM	LC	62.5/125	1310	-20	-14	-31	-14	2	11
			50/125		-23.5					7.5
FX52	SM	LC	9/125	1300	-15	-8	-31	-8	20	16
FX53	SM	LC	9/125	1300	-5	0	-34	0	50	29
FX54	SM	LC	9/125	1550	-5	0	-34	-10	90	29

Table 4.5. SFP Fast Ethernet Transceivers

4.4.2. Gigabit Ethernet (1Gbps) Optical Specifications

Fixed Gigabit Transceivers

Order Code	Mode	Connector Type	Cable Type (μm)	Tx λ (typ.) (nm)	Tx min (dBm)	Tx max (dBm)	Rx Sensitivity (dBm)	Rx Saturation (dBm)	Distance (typ.) (km)	Power Budget (dB)
FG01	MM	LC	50/125	850	-9	-2.5	-20	0	0.5	11
FG02	SM	SC	9/125	1310	-10	-3	-20	-3	10	10
FG03	SM	LC	9/125	1310	-9.5	-3	-21	-3	10	11.5
FG04	SM	SC	9/125	1310	-5	0	-20	-3	25	15
FG05	SM	LC	9/125	1310	-7	-3	-24	-3	25	17

Table 4.6. Fixed Gigabit Transceivers

SFP Gigabit Transceivers

Order Code	Mode	Connector Type	Cable Type (μm)	Tx λ (typ.) (nm)	Tx min (dBm)	Tx max (dBm)	Rx Sensitivity (dBm)	Rx Saturation (dBm)	Distance (typ.) (km)	Power Budget (dB)
FG51	MM	LC	50/125	850	-9	-2.5	-20	0	0.5	11
			62.5/125						0.3	
FG52	SM	LC	9/125	1310	-9.5	-3	-19	-3	10	9.5
FG53	SM	LC	9/125	1310	-7	-3	-23	-3	25	16
FG54	SM	LC	9/125	1550	0	5	-23	-3	70	23

Table 4.7. SFP Gigabit Transceivers

Notes:

1. Maximum segment length is greatly dependent on factors such as fiber quality, and the number of patches and splices. Please consult RuggedCom sales associates when determining maximum segment distances.
2. All optical power numbers are listed as dBm averages.
3. F51 transceivers are rated for -40°C to +85°C.

4.5. Operating Environment

Parameter	Range	Comments
Ambient Operating Temperature	-40°C to 85°C	Ambient Temperature as measured from a 30cm radius surrounding the center of the enclosure.

Table 4.8. Operating Environment

4.6. Mechanical Specifications

Parameter	Value	Comments
Dimensions	1.74 × 17.36 × 11.9 inches 44.20 × 440.94 × 302.26 mm	(Height × Width × Depth)
Weight	Approximately 10.3 lbs (4.7 kg)	Weight dependent on module selection.
Ingress Protection	IP40	
Enclosure	Aluminum	

Table 4.9. Mechanical Specifications

5. EMI And Environmental Type Tests

Test	Description		Test Levels	Severity Levels
IEC 61000-4-2	ESD	Enclosure Contact	+/- 8 kV	4
		Enclosure Air	+/- 15 kV	4
IEC 61000-4-3	Radiated RFI	Enclosure Ports	20 V/m	Note ^a
IEC 61000-4-4	Burst (Fast Transient)	Signal ports	+/- 4kV @ 2.5kHz	Note ^a
		D.C. Power ports	+/- 4kV	4
		A.C. Power ports	+/- 4kV	4
		Earth ground ports	+/- 4kV	4
IEC 61000-4-5	Surge	Signal ports	+/- 4kV line-to-earth, +/- 2kV line-to-line	4
		D.C. Power ports	+/- 2kV line-to-earth, +/- 1kV line-to-line	3
		A.C. Power ports	+/- 4kV line-to-earth, +/- 2kV line-to-line	4
IEC 61000-4-6	Induced (Conducted) RFI	Signal ports	10V	3
		D.C Power ports	10V	3
		A.C. Power ports	10V	3
		Earth ground ports	10V	3
IEC 61000-4-8	Magnetic Field	Enclosure Ports	40 A/m, continuous, 1000 A/m for 1 s	Note ^a
			1000 A/m for 1 s	5
IEC 61000-4-29	Voltage Dips & Interrupts	D.C. Power ports	30% for 0.1s, 60% for 0.1s, 100% for 0.05s	N/A
		A.C. Power ports	30% for 1 period, 60% for 50 periods	N/A
IEC 61000-4-11	Voltage Dips & Interrupts	A.C. Power ports	100% for 5 periods, 100% for 50 periods	N/A
IEC 61000-4-12	Damped Oscillatory	Signal ports	2.5kV common, 1kV diff. mode@1MHz	3
		D.C. Power ports	2.5kV common, 1kV diff. mode@1MHz	3
		A.C. Power ports	2.5kV common, 1kV diff. mode@1MHz	3
IEC 61000-4-16	Mains Frequency Voltage	Signal ports	30V Continuous, 300V for 1s	4
		D.C. Power ports	30V Continuous, 300V for 1s	4
IEC 61000-4-17	Ripple on D.C. Power Supply	D.C. Power ports	10%	3
IEC 60255-5	Dielectric Strength	Signal ports	2kVAC (Fail-Safe Relay output)	N/A
		D.C. Power ports	1.5kVDC	N/A
		A.C. Power ports	2kVAC	N/A
IEC 60255-5	H.V. Impulse	Signal ports	5kV (Fail-Safe Relay output)	N/A
		D.C. Power ports	5kV	N/A
		A.C. Power ports	5kV	N/A

^a RuggedCom-specified severity levels

Table 5.1. IEC 61850-3 EMI Type Tests

5. EMI And Environmental Type Tests

Test	Description		Test Levels
IEEE C37.90.3	ESD	Enclosure Contact	+/-2kV, +/-4kV, +/- 8kV
		Enclosure Air	+/-4kV, +/-8kV, +/-15kV
IEEE C37.90.2	Radiated RFI	Enclosure ports	35 V/m
IEEE C37.90.1	Fast Transient	Signal ports	+/- 4kV @ 2.5kHz
		D.C. Power ports	+/- 4kV
		A.C. Power ports	+/- 4kV
		Earth ground ports	+/- 4kV
IEEE C37.90.1	Oscillatory	Signal ports	2.5kV common mode @1MHz
		D.C. Power ports	2.5kV common, 1kV diff. mode@1MHz
		A.C. Power ports	2.5kV common, 1kV diff. mode@1MHz
IEEE C37.90	H.V. Impulse	Signal ports	5kV (Fail-Safe Relay output)
		D.C. Power ports	5kV
		A.C. Power ports	5kV
IEEE C37.90	Dielectric Strength	Signal ports	2kVAC
		D.C. Power ports	1.5kVDC
		A.C. Power ports	2kVAC

^a Meets Class 2 requirements for an all-fiber configuration. Meets Class 1 requirements for copper ports.

Table 5.2. IEEE 1613 (C37.90.x) EMI Immunity Type Tests^a

Test	Description		Test Levels
IEC 60068-2-1	Cold Temperature	Test Ad	-40°C, 16 Hours
IEC 60068-2-2	Dry Heat	Test Bd	+85°C, 16 Hours
IEC 60068-2-30	Humidity (Damp Heat, Cyclic)	Test Db	95% (non-condensing), 55°C , 6 cycles
IEC 60255-21-1	Vibration		2g @ (10 - 150) Hz
IEC 60255-21-2	Shock		30g @ 11mS

Table 5.3. Environmental Type Tests

6. Agency Approvals

Agency	Standards	Comments
TUV	UL 60950-1:2007, CAN/CSA-C22.2 No. 60950-1-07	
CE	EN 60950, EN 61000-6-2	CE Compliance is claimed via Declaration of Self Conformity Route
FCC	FCC Part 15, Class A	
CISPR	EN55022, Class A	
FDA/CDRH	21 CFR Chapter 1, Subchapter J	Laser Eye Safety
ISO	ISO9001:2008	Designed and manufactured using an ISO9001: 2008 certified quality program

Table 6.1. Agency Approvals

7. Warranty

RuggedCom warrants this product for a period of five (5) years from the date of purchase. This product contains no user-serviceable parts. Attempted service by unauthorized personnel shall render all warranties null and void. For warranty details, visit www.RuggedCom.com or contact your customer service representative.

Should this product require service, contact the factory at:

RuggedCom Inc.
300 Applewood Crescent
Concord, Ontario
Canada L4K 5C7
Phone: +1 905 856 5288
Fax: +1 905 856 1995

Free Manuals Download Website

<http://myh66.com>

<http://usermanuals.us>

<http://www.somanuals.com>

<http://www.4manuals.cc>

<http://www.manual-lib.com>

<http://www.404manual.com>

<http://www.luxmanual.com>

<http://aubethermostatmanual.com>

Golf course search by state

<http://golfingnear.com>

Email search by domain

<http://emailbydomain.com>

Auto manuals search

<http://auto.somanuals.com>

TV manuals search

<http://tv.somanuals.com>