



OWNER'S OPERATING MANUAL



CL-500



THE WORLD'S FINEST HOME THEATER PRODUCTS™

Limited Warranty

LIMITED WARRANTY

Congratulations on your purchase of a Runco video product and welcome to the Runco family! We believe Runco produces "The World's Finest Home Theater Products". With proper installation, setup and care, you will enjoy many years of unparalleled video performance. Please read this consumer protection plan carefully and retain it with your other important documents.

This is a LIMITED WARRANTY as defined by the U.S. Consumer Product Warranty and Federal Trade Commission Improvement Act.

WHAT IS COVERED UNDER THE TERMS OF THIS WARRANTY:

SERVICE LABOR: Runco will pay for service labor by an approved Runco service center when needed as a result of manufacturing defect for a period of two (2) years from the effective date of delivery to the end user.

PARTS (Not including projector lamp): Runco will provide new or rebuilt replacement parts for the parts that fail due to defects in materials or workmanship for a period of two (2) years from the effective date of the warranty. Such replacement parts are then subsequently warranted for the remaining portion (if any) of the original warranty period.

LAMP: Six months or 1000 hours (which ever comes first).

WHAT IS NOT COVERED UNDER THE TERMS OF THIS WARRANTY:

This warranty only covers failure due to defects in materials and workmanship that occur during normal use and does not cover normal maintenance. This warranty does not cover cabinets or any appearance item; any damage to laser discs; failure resulting from accident, misuse, abuse, neglect, mishandling, misapplication, faulty or improper installation or setup adjustments; improper maintenance, alteration, improper use of any input signal; damage due to lightning or power line surges, spikes and brownouts; damage that occurs during shipping or transit; or damage that is attributed to acts of God. In the case of remote control units, damage resulting from leaking, old, damaged or improper batteries is also excluded from coverage under this warranty.

CAUTION: DAMAGE RESULTING DIRECTLY OR INDIRECTLY FROM IMPROPER INSTALLATION OR SETUP IS SPECIFICALLY EXCLUDED FROM COVERAGE UNDER THIS WARRANTY. IT IS IMPERATIVE THAT INSTALLATION AND SETUP WORK BE PERFORMED ONLY BY AN AUTHORIZED RUNCO DEALER TO PROTECT YOUR RIGHTS UNDER THIS WARRANTY. THIS WILL ALSO ENSURE THAT YOU ENJOY THE FINE PERFORMANCE YOUR RUNCO PRODUCT IS CAPABLE OF PROVIDING WHEN INSTALLED AND CALIBRATED BY RUNCO AUTHORIZED PERSONNEL.

RIGHTS, LIMITS AND EXCLUSIONS:

Runco limits its obligations under any implied warranties under state laws to a period not to exceed the warranty period. There are no express warranties. Runco also excludes any obligation on its part for incidental or consequential damages related to the failure of this product to function properly. Some states do not allow limitations on how long an implied warranty lasts, and some states do not allow the exclusion or limitation of incidental or consequential damages. So the above limitations or exclusions may not apply to you. This warranty gives you specific legal rights, and you may also have other rights that vary from state to state.

EFFECTIVE WARRANTY DATE:

This warranty begins on the effective date of delivery to the end user. For your convenience, keep the original bill of sale as evidence of the purchase date.

IMPORTANT: WARRANTY REGISTRATION:

Please fill out and mail your warranty registration card. It is imperative that Runco knows how to reach you promptly if we should discover a safety problem or product update for which you must be notified.

TO OBTAIN SERVICE, CONTACT YOUR RUNCO DEALER:

Repairs made under the terms of the Limited Warranty covering your Runco International video product will be performed at the location of the product, during usual working hours, providing location of product is within normal operating distance from a Runco Authorized Service Center. If, solely in Runco's judgement, location of product to be repaired is beyond normal operating distance of the closest Runco Authorized Service Center, it is the owner's responsibility to arrange for shipment of the product for repair. These arrangements must be made through the selling Runco dealer. If this is not possible, contact Runco directly for a return authorization number and shipping instructions. Runco will return product transportation prepaid in the United States, unless no product defect is discovered. In that instance, shipping costs will be the responsibility of the owner.

ADDITIONAL INFORMATION:

To locate the name and address of the nearest Runco Authorized Service location, or for additional information about this warranty, please call, write or visit our website:

CUSTOMER SERVICE DEPARTMENT
RUNCO INTERNATIONAL
2900 Faber Street
Union City, CA 94587
Ph: (510) 324-7777 / Fax: (510) 324-9300
www.runco.com

Runco CL-500 Video Projector

User's Manual

Thank you for your purchase of this quality Runco video projector! It has been designed to provide you with the quality of video that is expected in a home theater. For the best performance, please read this manual carefully as it is your guide through the menus and operation.

WARNING

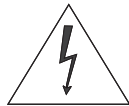
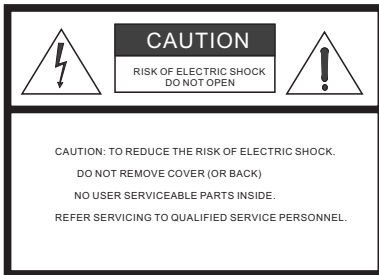

This symbol is intended to alert the user to the presence of uninsulated " dangerous voltage " within the product's enclosure that may be of sufficient magnitude to constitute a risk of electric shock.



This symbol is intended to alert the user to the presence of important operating and maintenance (servicing) instructions in the literature accompanying the appliance.

This equipment has been tested and found to comply with the limits for a Class B digital device, pursuant to Part 15 of the FCC Rules. These limits are designed to provide reasonable protection against harmful interference in a residential installation.

1. Read these instructions.
2. Keep these instructions.
3. Heed all warnings.
4. Do not use this projector near water, outdoors or otherwise exposed to the elements.
5. Clean only with a dry cloth.
6. Do not block any ventilation openings.
7. Do not install near any heat sources such as radiators, heat registers, stoves, or other apparatus (including amplifiers) that produce heat.
8. Do not defeat the safety feature of the polarized or grounding type plug. A polarized type plug has two blades with one wider than the other. A grounding type plug has two blades and a third grounding prong. The third prong is provided for your safety. If the provided plug does not fit into your outlet, consult an electrician for the replacement of the obsolete outlet.
9. The RJ11 telephone jack of RS323C port does not connect for telephone line connection.
10. The 12V trigger only output DC 12V signal for triggering. Do not connect to any other power input or output. This could cause damage to this unit.
11. Only use accessories specified by RUNCO International.
12. Keep the packing material in case the projector should ever need to be shipped.
13. Unplug this projector during lightning storms or when it will not be used for an extended period of time.
14. The lamp becomes extremely hot during operation. Allow the projector to cool down for approximately 45 minutes prior to removing the lamp assembly for replacement. Do not operate lamps beyond the rated lamp life. Excessive operation of lamps beyond rated life could cause them to explode in rare occasions.
15. Refer all servicing to qualified service personnel. Servicing is required when the projector has been damaged in any way, objects have fallen or spilled into the projector, the projector has been exposed to rain or moisture, does not operate normally, or has been dropped.

Table of Contents

WARNING	1
1.Overview	3
Features	3
Location	4
<i>Front / Upper Side</i>	4
<i>Rear / Bottom Side</i>	4
Controls and Functions	5
<i>Control Panel</i>	5
<i>Connector Panel</i>	6
<i>Remote Control</i>	7
2.Installation	8
Remote Control	8
Projector	8
<i>Connect the Power Cord</i>	8
<i>Adjust the Lens Zoom/Focus ring</i>	9
<i>Adjust the height</i>	9
Installation	10
Throw Distance Chart	11
3.Connecting	12
Connecting Video Inputs	12
<i>Video/S-Video/Component</i>	12
<i>Progressive Component (DTV Y/Pb/Pr)</i>	13
<i>RGBHV (DTV RGB)</i>	13
4.Basic Operation	15
Turning on the Power	15
Zoom / Focusing	15
Selecting Input Source	15
Selecting Video Memory	16
Selecting "ASPECT ratio"	16
Setting Menu	16
PIP function	17
Turning off the Power	17
5.Menu	18
Using the Menu	18
PICTURE Setting Page	18
DISPLAY Setting Page	19
ENVIRONMENT Setting Page	21
INSTALL Setting Page	21
6.Additional Information	22
Warning Message	22
Replace the Lamp	22
Troubleshooting	23
Specifications	24
Dimensions	25
RS-232 Setup	26

1. Overview

Features

■ High Contrast and Picture Quality

This single-DMD DLP™ projector provides excellent contrast ratio, color uniformity and seamless picture quality.

■ Fantastic Dynamic Performance and Rich Gray-scale

With a 6-segment color wheel, the picture's refresh rate can attain speeds of up to 240 Hz. By doing this, this unit provides fantastic dynamic performance and rich gray-scale without the 'color-flicker' or 'rainbowing' associated with other single-DMD DLP™ projectors.

■ Sealed Optical Engine with a High-Quality Lens Design

The optical engine uses a high-quality lens for maximizing optical performance. The sealed optical engine prevents light leakage and any dust from entering the engine, which could cause annoying 'spots' in the image.

■ Low Noise Operation

The projector's unique cooling system design prevents annoying fan noise, and is rated at less than 30 dB.

■ Wide Variety of Inputs

This unit can support various video formats, including Composite, S-Video, Component, DTV Y/P_B/P_R, DTV RGB and Computer signals. The HDTV input (DTV Y/P_B/P_R and DTV RGB) is input through RGB BNC port, providing the least amount of signal degradation caused by longer cable runs.

■ HDTV Ready

480i, 480P, 1080i and 720P (576I and 576P PAL Version) formats are all compatible with this unit (via an external DTV decoder, not provided).

■ De-interlacing with 3:2 Pull-down

Using Runco's proprietary De-interlacing technology, this projector provides exceptional scaling and film to video (3:2 pulldown) conversion for the most artifact-free images possible.

■ PIP function

Picture in picture functions allow you to display two inputs on the screen at the same time.

■ Video Memory

This projector allows the user to store up to three different settings in the video memories.

Location

■ Front / Upper Side

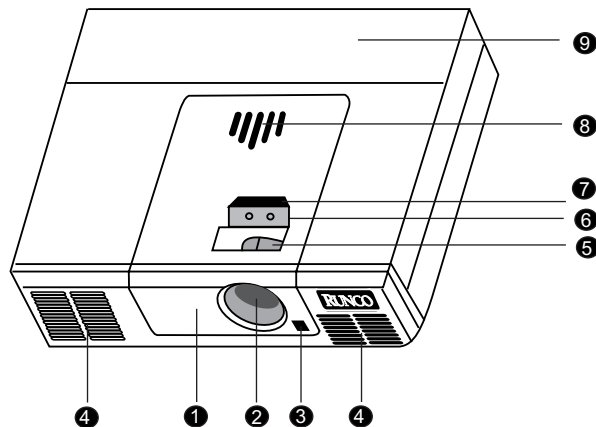

1. Front Lamp Cover

Remove this cover when replacing the lamp.

2. Projection Lens

3. Front IR Sensor

4. Ventilation Holes (exhaust)

5. Focus Ring and Zoom Ring

Adjusts the focus and zoom of image.

6. Power LED and Lamp LED

Show the status of power and lamp.
For more details, see "Control Panel" on page 5

7. Top IR Sensor

8. Power ON Indicator

9. Cord cover

■ Rear / Bottom Side

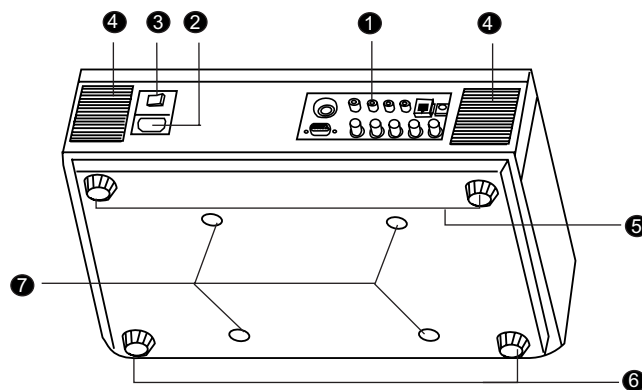

1. Connector Panel

For more details, see "Connector Panel" on page 6

2. AC Power IN Socket.

3. AC Power Switch

AC main power switch.

4. Ventilation Holes (intake)

5. Rear Adjusters

Adjust the height or projection angle

6. Front Adjusters

Adjust the height or projection angle

7. Ceiling mount holes

The connecting holes with ceiling mounting device.

Controls and Functions

■ Control Panel

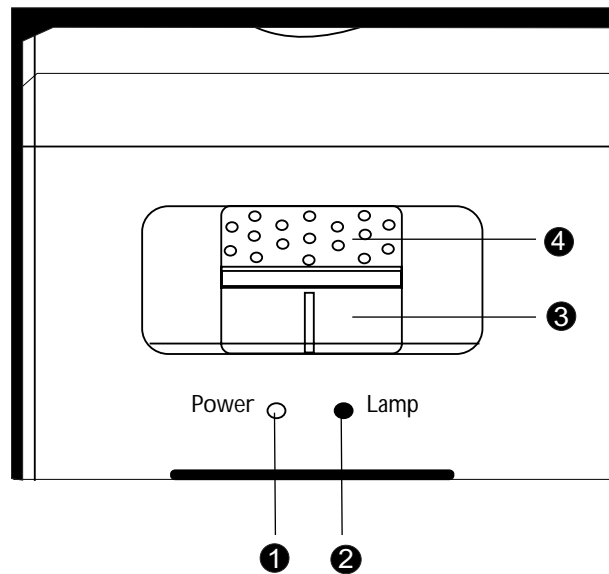

1. POWER LED

Indicate the status of the power

- Light Orange when the AC power cord is plugged into the wall outlet (standby mode). Once in the standby mode, you can turn on the projector by pressing ON key on the remote control for ONE second.
- Light Green when the power is turned on (operational mode).
- Flash Orange for the first 30 seconds after power-up indicating that the lamp is warming up.
- Flash Green for one minute after the projector was powered off indicating that the lamp is cooling down.

2. LAMP LED

Indicates the status of lamp

- Light red when the lamp has developed a problem. Please contact your Runco dealer for assistance.

3. Zoom Ring

Adjust the size of the image

- Rotate right to enlarge the image, and rotate left to make the image smaller.

4. Focus Ring

Adjust the focus of the image

- Rotate the focus ring right or left to focus the image.

■ Connector Panel

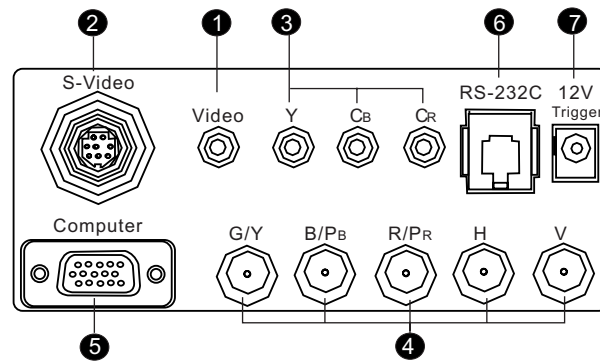

1. **Video (RCA Jack)**
Composite video signal input.
2. **S-Video (mini DIN 4-pin)**
Y/C (S-video) signal input
3. **Component (RCA Jacks)**
480i Component (Y/Cb/Cr) video signal input
4. **RGB/ HDTV (BNC)**
DTV Y/Pb/Pr or DTV RGB video signal input.
5. **Computer (D-Sub 15-pin)**
RGB Computer signal input.
6. **RS-232C (RJ-11 Jack)**
RS-232C control signal input.
7. **12v Trigger (mini jack)**
+12V output, active when the projector is turned on.

■ Remote Control

VIDEO: Composite video signal input.

S-VIDEO: S-Video signal input

COMPONENT: Component Y/CB/CR input

COMPONENT HD: DTV Y/PB/PR signal input

RGB HD: DTV RGBHV signal input

PC: Computer signal input

CUSTOM

Recall memory 1 ~ 3 sequentially (see "Selecting Video Memory" on page 16).

PICTURE

Access the Picture Setting menu (see "PICTURE Setting Page" on page 18).

ARROW (▲/◀/▼/▶)

Use to select the menu or to make various adjustments.

ENTER

Enter the setting of items in the menu.

EXIT

Exit and save the setting(s) of items in the menu.

MENU

Turns on /off the on-screen display menu.

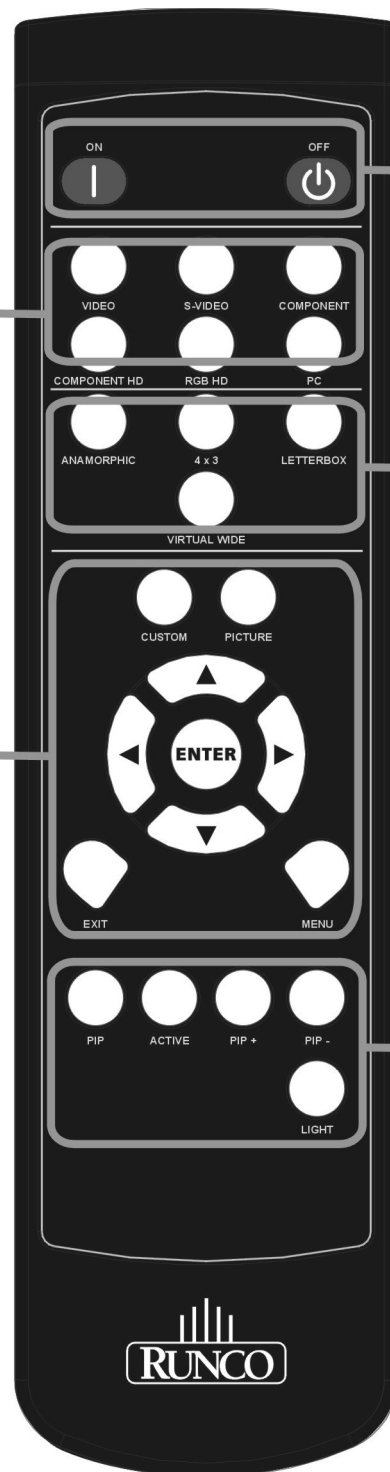

ON

Hold down this button for ONE second to turn on the unit.

OFF

Press this button to turn off the unit.

ANAMORPHIC: For 16:9 DVDs.

4 X 3: The input signal will be scaled to fit 4:3 display mode in the center of screen.

LETTERBOX: Letter box mode. Image in letter box format is enlarged to fit 16:9 full screen display and the upper/lower portion are 'blanked off'.

VIRTUAL WIDE: 4:3 image is enlarged NON-linearly in horizontal direction to fit 16:9 full screen display.

PIP (Picture in Picture)

Enable the PIP function. Use ARROW keys to adjust the position of the PIP window (see "PIP function" on page 17)

ACTIVE: Switch to the active window in PIP display mode.

PIP+: Enlarge the size of PIP window.

PIP-: Shrink the size of PIP window.

LIGHT: Turn on the backlight of remote control.

2. Installation

Remote Control

Push and slide to open the cover. Install the two AAA batteries with the correct polarity, then close the cover.

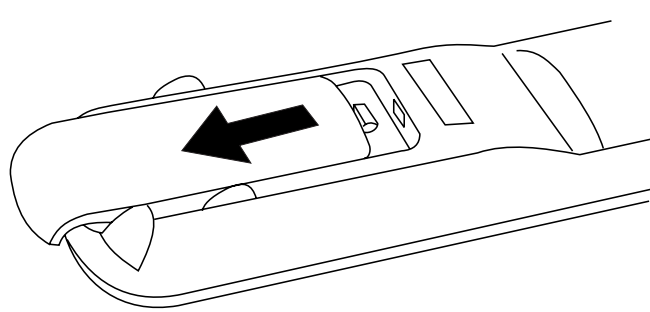

Notes on Batteries

- Make sure that the battery polarities are correct when installing the batteries.
- Do not mix an old battery with a new one or different types of batteries.
- If you will not use the remote control for a long time, remove the batteries to avoid damage from battery leakage.

Notes on Remote Control Operation

- Make sure that there is nothing obstructing the infrared beam between the remote control and the IR receiver on the projector.
- The useable range is between 3m (from the front of the projector) and 4m (from the rear of the projector) within 30 degree horizontal angle and 15 degree vertical angle.

Projector

■ Connect the Power Cord

Plug the supplied power cord into the AC inlet in the rear of this unit.

Turn on the main power switch in the rear of this unit (next to the AC inlet). The POWER LED will light up in orange. Press ON key on the remote control for ONE second to turn on the unit.

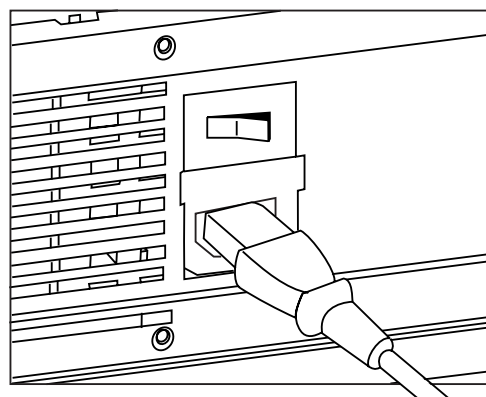

■ Adjust the Lens Zoom/Focus ring

Adjust the projected image size you need with the zoom ring on the lens. To focus the image, rotate the focus ring on the lens.

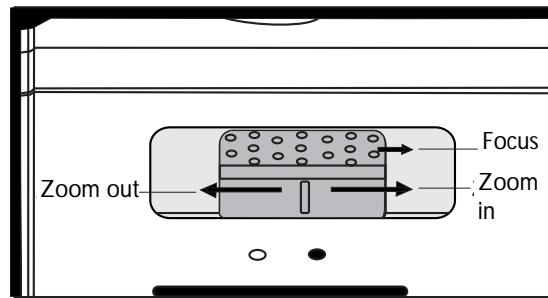

■ Adjust the height

There are 4 screw adjusters on the bottom of this unit. You can adjust the height or projection angle of this unit by using these adjusters.

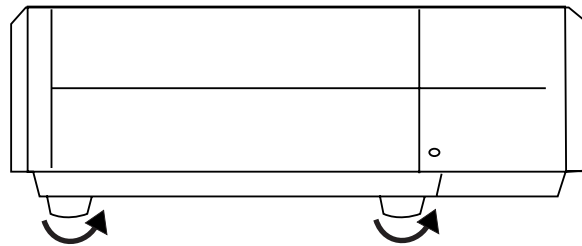

Installation

Ceiling

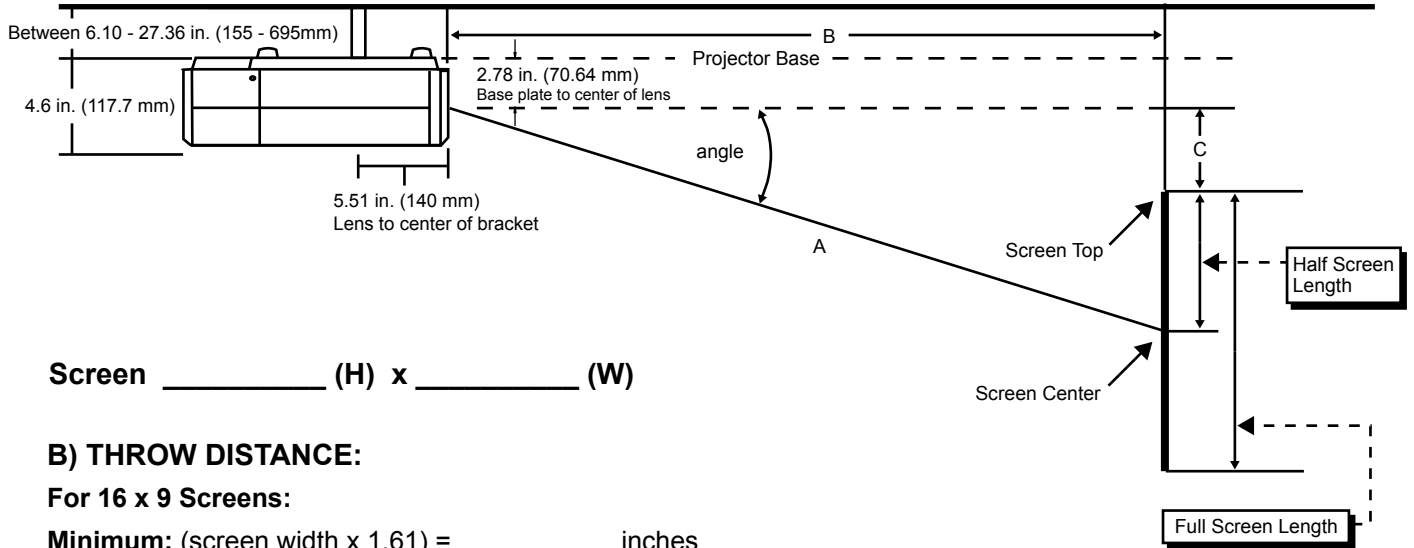

Screen _____ (H) x _____ (W)

B) THROW DISTANCE:

For 16 x 9 Screens:

Minimum: (screen width x 1.61) = _____ inches

Maximum: (screen width x 2.04) = _____ inches

For 4 x 3 Screens:

Minimum: (screen width x 1.75) = _____ inches

Maximum: (screen width x 2.20) = _____ inches

C) VERTICAL OFFSET:

Distance between lens center and top edge of viewing area (bottom edge for floor mount): □

For use on 16 x 9 ratio screens: (screen width x .215) = _____ inches

For use on 4 x 3 ratio screens: (screen width x .12) = _____ inches

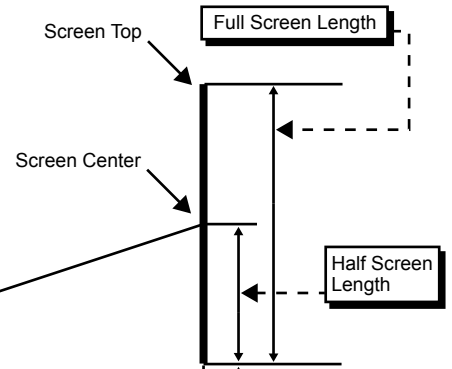

Floor

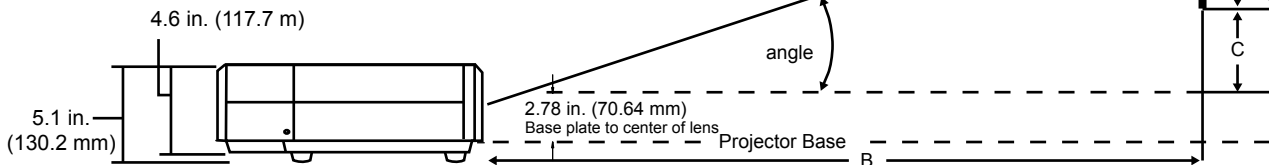

Throw Distance Chart

CL-500 16 x 9 Aspect Ratio Screen

Screen Height	Screen Width	Min Throw Distance	Max Throw Distance	Vertical Offset Position
40.50	72.00	116.06	147.06	15.50
43.00	77.00	123.23	156.14	16.46
45.00	80.00	128.96	163.40	17.22
47.00	84.00	134.69	170.67	17.99
49.00	87.00	140.42	177.93	18.75
50.00	89.00	143.29	181.56	19.14
51.50	92.00	147.59	187.01	19.71
52.00	93.00	149.02	188.82	19.90
54.00	96.00	154.75	196.08	20.67
56.00	100.00	160.48	203.35	21.43
58.00	103.00	166.22	210.61	22.20
58.50	104.00	167.65	212.43	22.39
60.00	107.00	171.95	217.87	22.96
61.00	109.00	174.81	221.50	23.34
63.00	112.00	180.55	228.77	24.11
65.00	116.00	186.28	236.03	24.88
67.50	120.00	193.44	245.11	25.83
72.00	128.00	206.34	261.45	27.55
80.00	142.00	229.26	290.50	30.62
82.00	146.00	235.00	297.76	31.38
90.00	160.00	257.92	326.81	34.44
Screen Height	Screen Width	Min Throw Distance	Max Throw Distance	Vertical Offset Position
		SW x 1.61	SW x 2.04	SW x .215

CL-500 1.33 (4x3) Aspect Ratio Screen

Screen Height	Screen Width	Min Throw Distance	Max Throw Distance	Vertical Offset Position
36.00	48.00	84.00	105.60	5.76
45.00	60.00	105.00	132.00	7.20
50.00	67.00	117.25	147.40	8.04
52.00	69.00	120.75	151.80	8.28
54.00	72.00	126.00	158.40	8.64
60.00	80.00	140.00	176.00	9.60
67.67	90.00	157.50	198.00	10.80
72.00	96.00	168.00	211.20	11.52
79.70	106.00	185.50	233.20	12.72
90.00	120.00	210.00	264.00	14.40
108.00	144.00	252.00	316.80	17.28
Screen Height	Screen Width	Min Throw Distance	Max Throw Distance	Vertical Offset Position
		SW x 1.75	SW X 2.20	SW x .12

3. Connecting

When connecting, make sure to:

1. Turn off all equipment before making any connections.
2. Use the correct signal cables for each source.
3. Ensure the cables are firmly connected.
4. Connect all audio signals to external speakers. This projector is not equipped with speakers.

Connecting Video Inputs

■ Video/ S-Video/ Component (Interlaced Video)

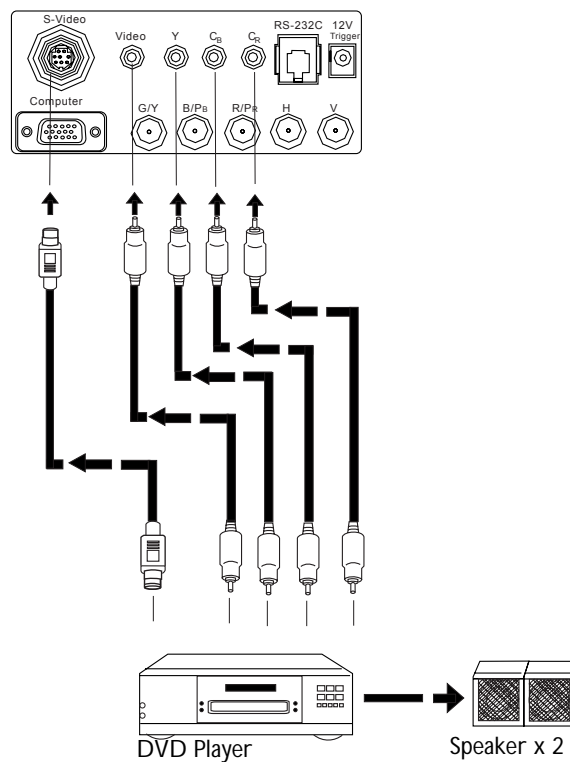

■ Progressive Component (DTV Y/P_B/P_R)

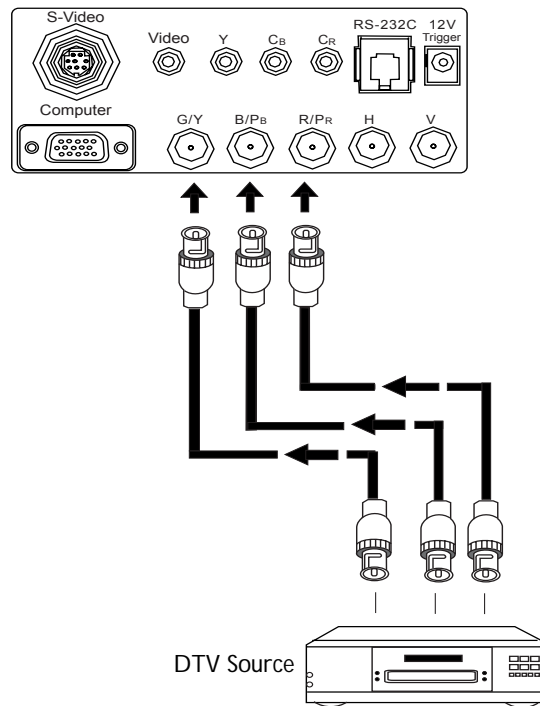

■ RGBHV (DTV RGB)

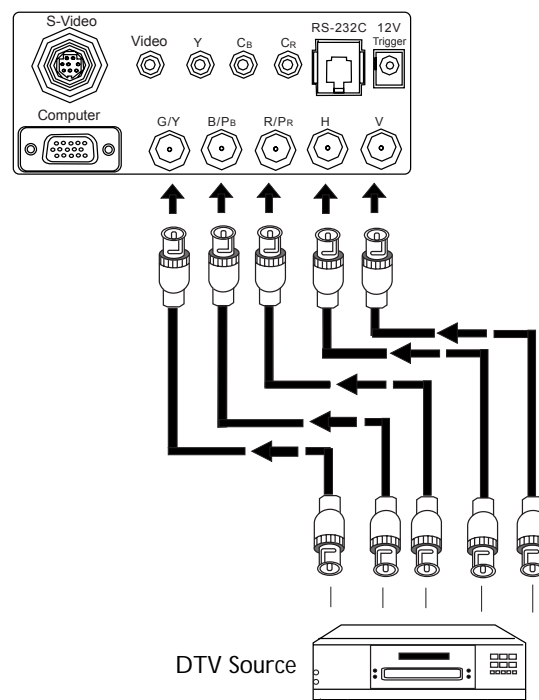

The RGB BNC input supports two kinds of HDTV formats: Progressive component (DTV Y/P_B/P_R) and DTV RGB. The unit will auto detect the resolution automatically.

Connecting a Computer

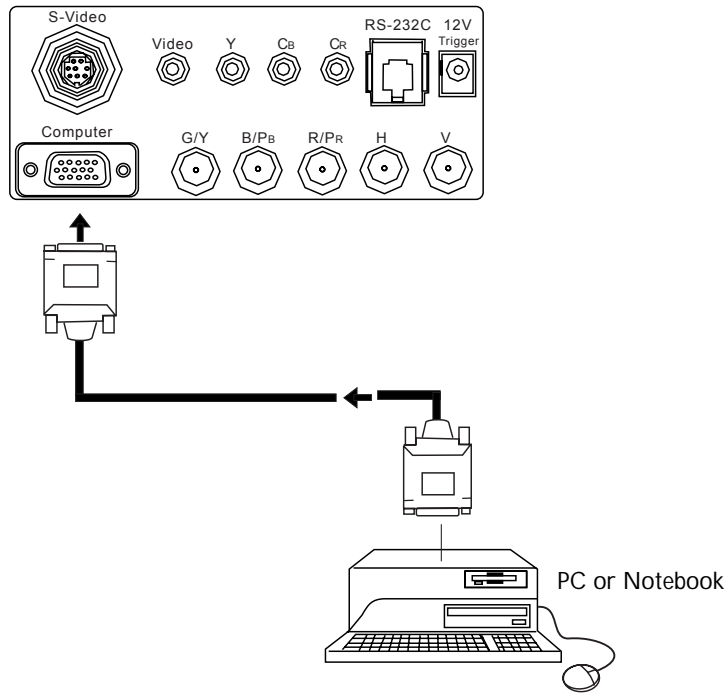

This unit only supports resolutions up to XGA. If the input signal is greater than XGA, the projector will display a warning message.

4. Basic Operation

Turning on the Power

- The Power LED lights orange when power is applied and the power switch is turned on.
- Press and hold the ON key on the remote control for ONE second to turn on the unit. The POWER LED will blink orange during warm up period, then light solid green.
- " Searching..." will be displayed on the screen before the projector identifies the input signal. This message will remain on the screen until a valid signal is detected.
- If the horizontal frequency of the input signal exceeds the range of the projector (XGA), a " Not supportive timing " message will be displayed on the screen. This message will remain on screen until you change the input signal.

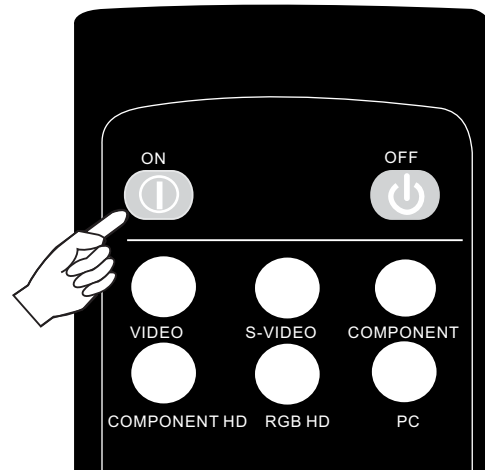

Zoom/ Focusing

- Adjust the projection image size you need with the zoom ring on the lens. To focus the image, rotate the focus ring on the lens.

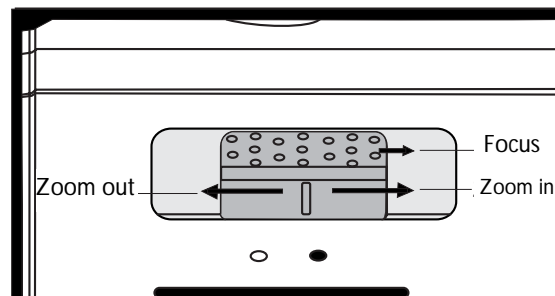

Selecting Input Source

- When this unit is turned on, it will search for the input source you selected last time.
- You may select the input source directly on the remote control.

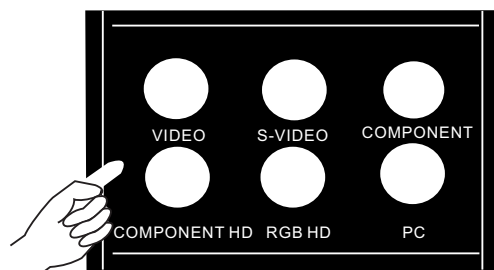

Selecting "ASPECT ratio"

- Select the proper Aspect Ratio according to the format of signal content. There are four Aspect Ratio for choice:
- ANAMORPHIC: 4:3 image is stretched horizontally to fit the 16: 9 screen. This is for 16:9 DVDs.
- 4 X 3: The input signal will be scaled to fit 4 : 3 display mode in the center of screen.
- LETTERBOX: Letter box mode. Image in letter box format is enlarged to fit 16:9 full screen display and the upper/lower portion are compressed.
- VIRTUAL WIDE: 4:3 image is enlarged NON-linearly in horizontal direction to fit 16: 9 full screen display.

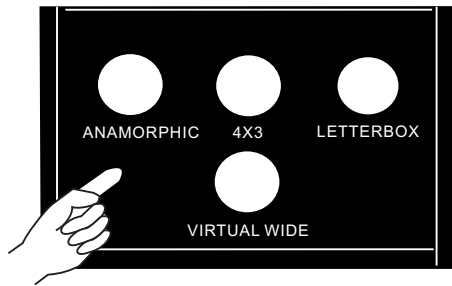

Selecting Video Memory

- Press the CUSTOM button to recall a setting in the memory. Each time you press this button, the unit will recall the settings as follows: MEMORY 1 → MEMORY 2 → MEMORY 3 → OFF.

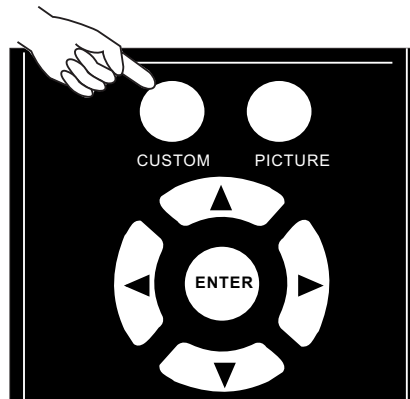

Setting Menu

- Press the MENU button to turn on /off the on-screen display menu.
- Use the ARROW buttons (▲/◀/▼/▶) to select the menu or to make various adjustments.
- Press the ENTER button to enter the setting of items in the menu, or press the EXIT button to leave and save the setting of items in the menu.
- For more detail settings, see "5. Menu" on page 18

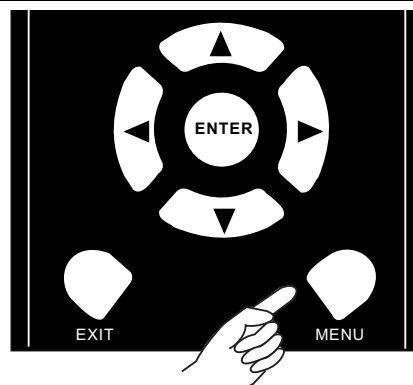

PIP function

- Press the PIP button to enable the PIP function
- For PIP purposes, there are two groups of inputs separated by their display modes:
Video Group: Video, S-Video and Component Y/Cb/Cr inputs
Graphic Group: HDTV input and Computer input.
- The PIP can show one input from the Graphic Group within one input from the Video Group, or show one input from Video Group within one input from the Graphic Group.
- Press the PIP button to switch to the main window or turn off PIP function.
- Select the input source of main window by pressing the INPUT button.
- Press the ACTIVE button to switch to the active window. You can change the the input signal setting in active window.
- Press PIP+ or PIP- to adjust the size of PIP window.
- Adjust the position of the PIP window with the ARROW keys (▲/◀/▼/▶).

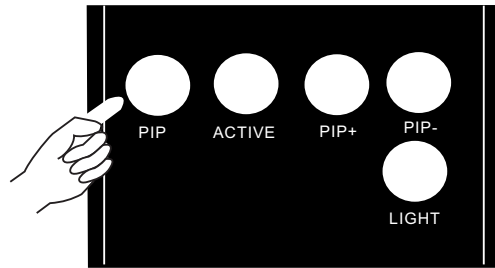

Turning off the Power

- Press the OFF key on the remote control to turn off the unit
- After turning off the unit, the POWER LED will blink green and the fans will operate for 1 minute to cool down the lamp. The projector will not respond to any command until cooling down process is completed. The POWER LED will light solid orange once the cooling down cycle has completed.

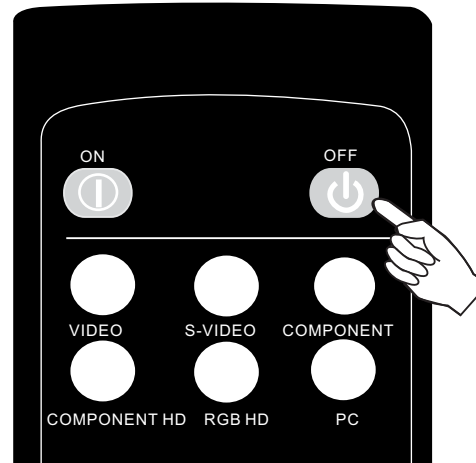

5. Menu

Using the Menu

This unit is equipped with an on screen display (OSD) menu for making various adjustments and settings.

There are 3 different menu languages; page 21 Language setting for more details.

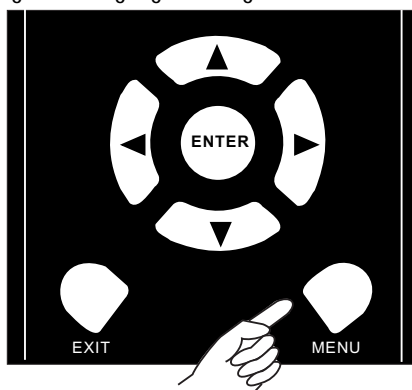

- Press the MENU button to turn on /off the on-screen display menu.
- Use the ARROW buttons (▲/◀/▼/▶) to select the menu or to make various adjustments.
- Press the ENTER button to enter the setting of items in the menu, or press the EXIT button to leave and save the setting of items in the menu.

PICTURE Setting Page

In this Menu, all 'front panel' adjustments can be made. These settings can be stored in 3 separate video memories, in which each can have different parameters for different sources.

There are 12 Menu Items: BRIGHTNESS — CONTRAST — COLOR — SHARPNESS — TINT — COLOR TEMPERATURE — FILTERS — RED — GREEN — BLUE — YELLOW — WHITE.

RUNCO CL-500		
PICTURE	DISPLAY	ENVIRON. INSTALLATION
BRIGHTNESS		10
CONTRAST		10
COLOR		10
SHARPNESS		10
TINT		10
COLOR TEMP.		10
FILTERS		10
RED		10
GREEN		10
BLUE		10
YELLOW		10
WHITE		10

1. BRIGHTNESS: Adjust the picture brightness (0 ~ 60) . Higher the setting, brighter the picture. And lower the setting, darker the picture.
2. CONTRAST: Adjust the picture contrast (0 ~ 30). Higher the setting, greater the contrast. And lower the setting, lower the contrast.
3. COLOR: Adjust color intensity (0 ~ 30). Higher the setting, the greater the color intensity. And lower the setting, lower the color intensity.
4. SHARPNESS: Adjust the picture sharpness (0 ~ 6). Higher the setting, the sharper the picture. And lower the setting, the softer the picture.

5. TINT: Adjust color tones (0 ~ 30). The higher the setting, the picture becomes greenish. The lower the setting, the picture becomes purplish.
6. COLOR TEMP.: Adjust the color temperature.
 - 0 : The default color temperature of lamp.
 - 1 : Low color temperature (6500°K). Make the white color reddish.
 - 2 : Middle color temperature (9000°K). Make the white color normal.
 - 3 : High color temperature (11500°K). Make the white color bluish.
7. FILTERS: Turn on /off the video filters. This could reduce the noise in the picture to get sharper picture. There are 4 filters for video input (0 ~ 3) and 2 filters for graphic input (0 ~ 1). Higher the setting, the less the noise.
8. RED: Adjust red color independently (0 ~ 30). Higher the setting, the greater the red color intensity. And lower the setting, lower the red color intensity.
9. GREEN: Adjust green color independently (0 ~ 30). Higher the setting, the greater the green color intensity. And lower the setting, lower the green color intensity.
10. BLUE: Adjust blue color independently (0 ~ 30). Higher the setting, the greater the blue color intensity. And lower the setting, lower the blue color intensity.
11. YELLOW: Adjust yellow color independently (0 ~ 30). Higher the setting, the greater the yellow color intensity. And lower the setting, lower the yellow color intensity.
12. WHITE: Adjust the white color independently (0 ~ 10). Higher the setting, the greater the white color intensity. And lower the setting, lower the white color intensity.

DISPLAY Setting Page

In this Menu Page, you could set the way how the projector display the picture.

There are 5 Menu Items in this page: SOURCE — ASPECT — PC&HDTV — SAVE — LOAD.



1. SOURCE: Select the input source.
 - VIDEO: Composite video signal input.
 - S-VIDEO: S-Video signal input
 - COMPONENT: Component Y/C_B/C_R input
 - COMPONENT HD: DTV Y/P_B/P_R input
 - RGB HD: DTV RGBHV signal input
 - PC: Computer signal input PC

2. ASPECT: There are four aspect ratios available that can be selected for video signal inputs.

The aspect ratios will be created differently for 16:9 screens and 4:3 screens as described below:

16:9 Screens:

ANAMORPHIC: The image is compressed vertically, but anamorphic software will appear properly proportioned. This is best suited for use with 16:9 DVD's.



4 x 3: The input signal will be scaled to fit in the center of the 16:9 screen.

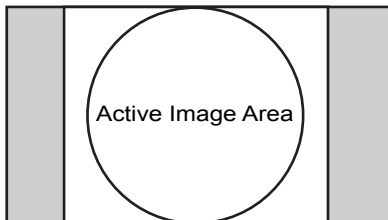

LETTERBOX: The image in the Letterbox mode will be stretched vertically, and the top and bottom portion 'blanked off'. This ratio is best suited for LaserDisc movies or non-anamorphic DVD's.



VIRTUAL WIDE: A 4:3 image is horizontally stretched non-linearly to allow a 4:3 image to completely fill a 16:9 screen without using any blanking.

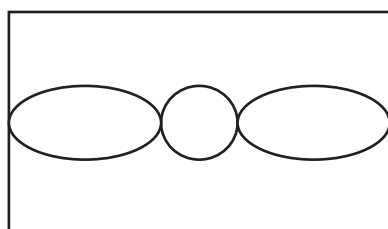

4:3 Screens:

4 x 3: The input signal will fill the entire screen

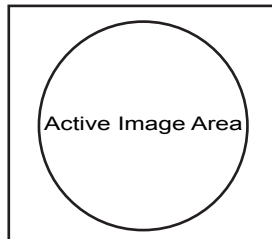

ANAMORPHIC: The image is compressed vertically, but anamorphic software will appear properly proportioned. This is best suited for use with 16:9 DVD's.

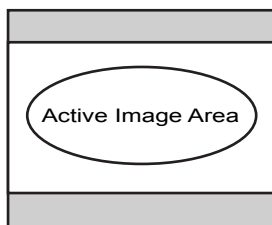

LETTERBOX: The top and bottom of the widescreen image (within the 4:3 screen) will be 'blanked off'. This is best suited for LaserDisc movies or non-anamorphic DVD's.

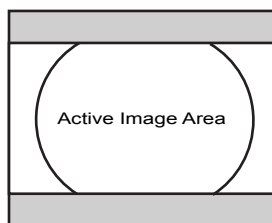

VIRTUAL WIDE: a 4:3 image is horizontally stretched non-linearly to allow a 4:3 image to completely fill a 16:9 screen without using any blanking (This ratio is available for 4:3 screens, but is most useful only on 16:9 screens).

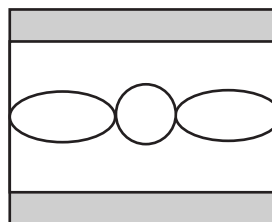

3. PC & HDTV: The following settings are only available with a PC or DTV RGB signal:

- * AUTO: Adjusts the phase, frequency and position signal.
- * PHASE: Adjusts the phase of signal.
- * FREQUENCY: Adjusts the frequency of signal.
- * H. POS.: Adjusts the horizontal position of the image.
- * V. POS.: Adjusts the vertical position of image.

4. SAVE: There are 3 video memories in which the user could save their settings, including all menu items of the Picture Setting Menu.

5. LOAD: Loads the settings from one of three video memories.

ENVIRONMENT Setting Page

In this Menu, the global settings for the projector can be made.

There are 5 Menu Items: DEFAULT — LAMP TIMER — BACK LIGHT — AUTO OFF — LAMP HOURS.

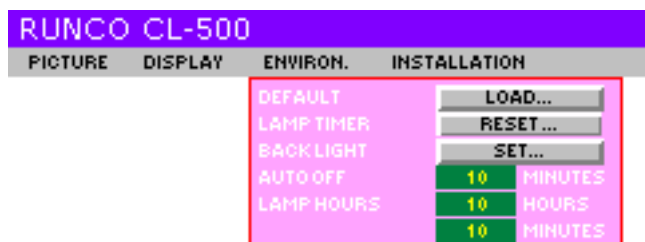

1. DEFAULT: Load the default value of current input source.
2. LAMP TIMER: Resets the lamp timer. This should only be done after the lamp has been replaced.
3. BACK LIGHT: Turn on/off the Power ON Indicator.
4. AUTO OFF: Set the auto shutdown timer. The setting timer is from 10 minutes to 3 hours.
5. LAMP HOURS: This displays the number of hours the lamp has been used (the useable lifetime of the lamp is 1500 hours). If the lamp hours exceed 1500, a warning message will be displayed on screen; when this happens, contact your Runco dealer for a new lamp.

INSTALL Setting Page

This menu contains items necessary for installation.

There are 4 Menu Items included: LANGUAGE, MIRROR, KEYSTONE and SCREEN.

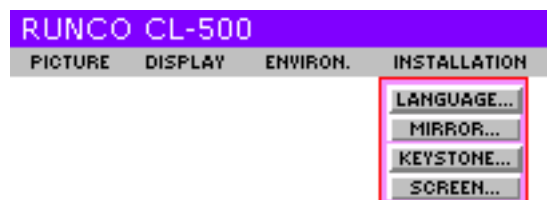

1. LANGUAGE: There are 3 languages that could be selected for the menus: English, French and Spanish.
2. MIRROR: The projector could be installed on a ceiling or behind a screen, or with one or more mirrors. There are four settings:
 - FLOOR FRONT
 - CEILING FRONT
 - FLOOR REAR
 - CEILING REAR
3. KEYSTONE: Corrects for trapezoidal distortion as a result of the angle of projection (-12 ~ +12). This can correct for up to ± 12 degrees of offset.
4. SCREEN: Select the right aspect ratio for your screen.
 - 4 X 3
 - 16 X 9

6. Additional Information

Warning Message

<ul style="list-style-type: none"> ■ It is normal for lamp to be darker when this unit has been used for a period of time. ■ " Lamplife is expired ! Please change a new lamp. And reset the lamp timer " message will be displayed for 30 seconds on the screen if the lamp has operated for 1450 hours. 	<p>Lamplife is expired ! Please change new lamp And reset the lamp timer</p>
<ul style="list-style-type: none"> ■ " Please change the lamp, Lamp will exceed its lifetime after (hours): " message will be displayed on the screen for 30seconds for each time turning on, if the lamp has operated for 1480 hours. And the number will count down continuously. 	<p>Please change the lamp ! Lamp will exceed its lifetime after (hours):</p>
<ul style="list-style-type: none"> ■ " Please change the lamp ! " message will display on the screen all the time and the POWEER LED will blink in orange and green sequentially if the lamp has operated for more than (1,500) hours. ■ The power will turn off automatically after 10 minutes. 	<p>Please change the lamp !</p>

Replace the Lamp (Contact your Runco Dealer)

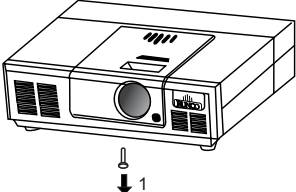
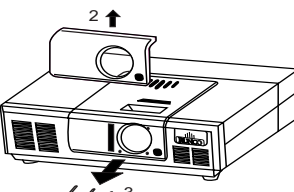
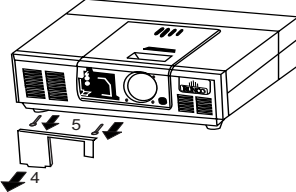
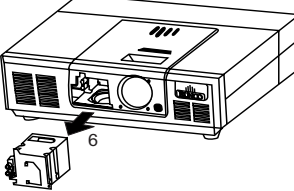
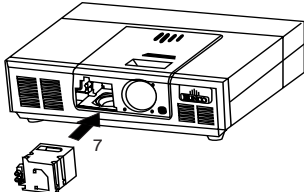
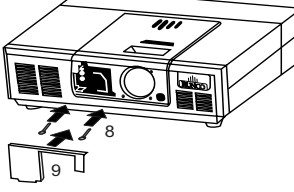
<p>1. Loosen the screw of front lamp cover</p> 	<p>2. Take off the front lamp cover</p> <p>3. Loosen the three screws of lamp shield</p> 
<p>4. Take off the lamp shield</p> <p>5. Loosen the two screws of lamp module.</p> 	<p>6. Pull out the lamp module horizontally.</p> 
<p>7. Insert the new lamp module into this projector horizontally until it is securely in place.</p> 	<p>8. Tighten the two screws of lamp module.</p> <p>9. Put on the lamp shield.</p> 

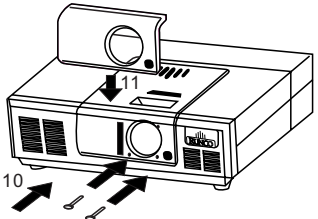
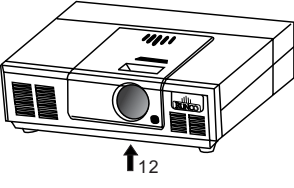
<p>10. Tighten the three screws of lamp shield.</p> <p>11. Put on the front lamp cover.</p>		<p>12. Tighten the screw of front lamp cover.</p> <p>13. Turn on the power and go into Environment Setting Page to reset the "Lamp Timer " item.</p>	
---	---	--	---

Troubleshooting

Problem	Cause	Remedy
This unit does not turn on.	There is no power from power cable.	Plug the power cord into the AC inlet on the rear of this unit, and plug the power cord into to the power inlet.
	The power switch is not turned on.	Turn on the power switch.
	Turn on this unit again within the cooling down procedure.	Wait this unit complete the cooling down procedure.
	Front lamp cover is not attached well.	Correctly attach the front lamp cover.
No picture	The front lamp cover is not correctly attached.	Correctly attach the front lamp cover.
	This unit is not correctly connected to the input source device.	Check the connection.
	The input signal has not been correctly selected.	Select the correct input signal with INPUT key on the remote control.
	The input signal has not been correctly selected in " INPUT SOURCE " item in " DISPLAY Setting Page " .	Select the correct input signal.
	POWER LED or LAMP LED blinking.	Please contact your Runco dealer for assistance.
Image is unstable	The connection cables are not connected to this unit.	Correctly connect the cables to the appropriate terminals.
Picture is burred	The projection lens is not correctly focused.	Adjust the focus of projection lens with the focus ring.
	This unit and the screen are not placed squarely. (90 degree)	Adjust the projection angle and direction, and the height of this unit.
Remote control does not work correctly	The batteries are exhausted.	Replace both batteries with new ones.
LAMP LED blink in red	The front lamp cover is not correctly attached.	Correctly attach the front lamp cover.
	The cooling fan does not work well.	Please contact your Runco dealer for assistance.
	The temperature inside this unit is extremely high.	Check that the ventilation holes are not blocked.
POWER LED blink in orange and green sequentially	The lamp has exceed its specified usage hours.	Replace the lamp with a new one.
	The lamp has burned out.	Replace the lamp with a new one.

Specifications

Projector Type:	Digital Light Processing™ (DLP™)
Native Resolution:	848 x 600
Video Standards:	NTSC, NTSC 4.43, PAL-M, PAL-N, SECAM
Lamp:	150W P-VIP
Lamp Life:	1500 hours
Picture Size:	40" to 300" diagonal
Throw Distance:	For 16:9 Screens: 1.61 to 2.04 x screen width For 4:3 Screens: 1.75 to 2.2 x screen width
Vertical Offset:	For 16:9 Screens: .215 x screen width For 4:3 Screens: .12 x screen width
Light Output:	1000 ANSI lumens
Inputs:	Composite, S-video, RGB/Component (via BNC), Component (RCA), RGB (DB 15)
Contrast Ratio:	900:1
Power Requirements:	100-240 VAC, 200W
12V Output:	Max .250 Amp, active when the projector is on
Dimensions (w/out feet):	Width: 15.75 in. / 400 mm Depth: 13.66 in. / 347 mm Height: 4.6 in. / 117.7 mm
Weight:	14.8 lbs. (6.7 kg)
Regulatory Approvals:	UL, CSA, GS-TUV, CCIB, CB, FCC, CE, VCCI and C-Tick
Operating Environment:	41°-95° F (5°- 35° C), 20%-80% Humidity
Warranty:	Service Labor and Parts: Runco warrants the product for (2) two years from the date of delivery to the end user.
Lamp Warranty:	1000 hours or (6) six months, which ever comes first.

* Optional ceiling bracket available.

Dimensions

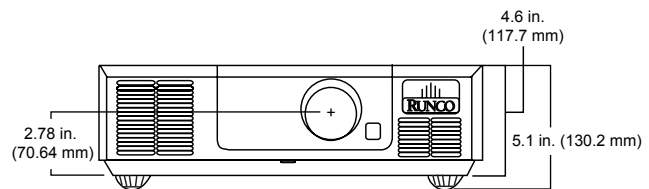
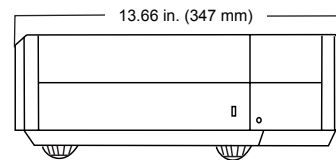
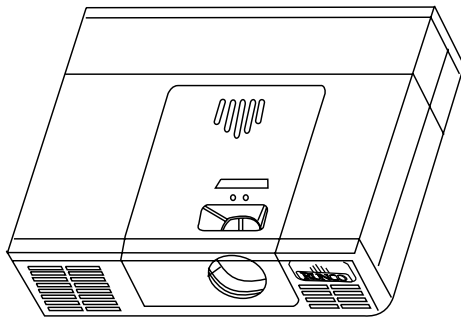
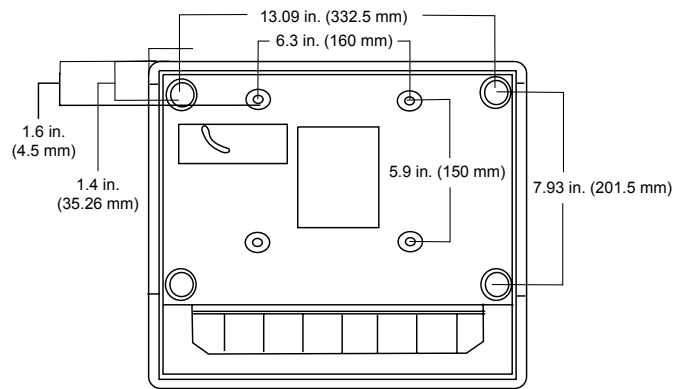
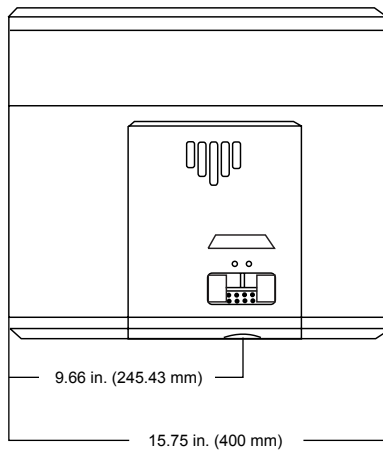

Unit: in. (mm)

RS-232 Setup

Baud Rate : 115200
Parity : None
Data Bits : 8 Bits
Stop Bits : 1 Bit
Flow Control : None

RS-232C Control Codes

- | Code | Function |
|------|-----------------------------------|
| X01 | Power On |
| X02 | Power Off |
| X03 | Message On |
| X04 | Message Off |
| X10 | Menu (arrow key) |
| X11 | Enter (arrow key) |
| X12 | Exit (arrow key) |
| X13 | Up (arrow key) |
| X14 | Down (arrow key) |
| X15 | Left (arrow key) |
| X16 | Right (arrow key) |
| X20 | Switch to Composite input |
| X21 | Switch to S_Video input |
| X22 | Switch to Component input |
| X23 | Switch to D-sub_PC input |
| X24 | Switch to YPBPR input |
| X25 | Switch to BNC_PC input |
| X35 | Anamorphic |
| X36 | Standard |
| X37 | Letter box |
| X38 | Virtual Wide |
| X40 | Load memory 1 settings |
| X41 | Load memory 2 settings |
| X42 | Load memory 3 settings |
| X46 | Load default of current source |
| X47 | Save memory 1 settings |
| X48 | Save memory 2 settings |
| X49 | Save memory 3 settings |
| X55 | Switch active source |
| X56 | Picture in picture display |
| X57 | Picture in picture display |
| X60 | Switch language - English |
| X61 | Switch language - French |
| X62 | Switch language - Spanish |
| X85 | PC Input - auto |
| X90 | Image orientation - floor front |
| X91 | Image orientation - ceiling front |
| X92 | Image orientation - floor rear |
| X93 | Image orientation - ceiling rear |
| X94 | Back light on |
| X95 | Back light off |

PC Out Adapter

- 1) Connect D-Sub 9-pin female to RJ-11 adapter (not included) to Com port on PC.
- 2) Connect RJ-11 to Projector.

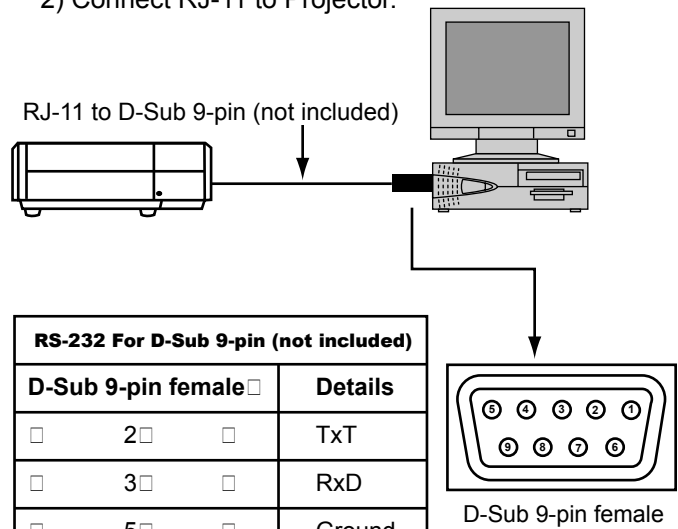

RS-232 For D-Sub 9-pin (not included)		
D-Sub 9-pin female		Details
<input type="checkbox"/> 2 <input type="checkbox"/>	<input type="checkbox"/>	TxT
<input type="checkbox"/> 3 <input type="checkbox"/>	<input type="checkbox"/>	RxD
<input type="checkbox"/> 5 <input type="checkbox"/>	<input type="checkbox"/>	Ground
1, 4, 6, 7, 8, 9	<input type="checkbox"/>	NC

RS-232 For RJ-11 (not included)		
4-pin RJ-11		Details
<input type="checkbox"/> 2 <input type="checkbox"/>	<input type="checkbox"/>	TxT
<input type="checkbox"/> 3 <input type="checkbox"/>	<input type="checkbox"/>	RxD
<input type="checkbox"/> 1, 4 <input type="checkbox"/>	<input type="checkbox"/>	Ground

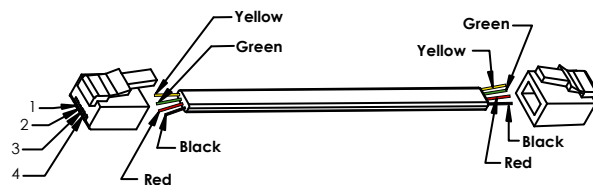

NOTE:

1. All codes are in the ASCII format
2. A carriage return is required after each command.

RUMA-009550 rev 4-02



THE WORLD'S FINEST HOME THEATER PRODUCTS™

Runco International • 2463 Tripaldi Way • Hayward, CA 94545 • ph (510) 293-9154 • fax (510) 293-0201 • www.runco.com

Free Manuals Download Website

<http://myh66.com>

<http://usermanuals.us>

<http://www.somanuals.com>

<http://www.4manuals.cc>

<http://www.manual-lib.com>

<http://www.404manual.com>

<http://www.luxmanual.com>

<http://aubethermostatmanual.com>

Golf course search by state

<http://golfingnear.com>

Email search by domain

<http://emailbydomain.com>

Auto manuals search

<http://auto.somanuals.com>

TV manuals search

<http://tv.somanuals.com>