



OWNER'S OPERATING MANUAL



CL-610 Series

Digital Light Processing™ Projectors

CL-610

CL-610LT

CL-610 CineWide™

CL-610LT CineWide™



THE WORLD'S FINEST HOME THEATER PRODUCTS™

TWO YEAR LIMITED WARRANTY

For Projectors, Video Processors and Controllers

Congratulations on your purchase of a Runco video product and welcome to the Runco family! With proper installation, setup and care, you should enjoy many years of unparalleled video performance.

This is a LIMITED WARRANTY as defined in the Magnuson-Moss Warranty Act. Please read it carefully and retain it with your other important documents.

WHAT IS COVERED UNDER THE TERMS OF THIS LIMITED WARRANTY:

SERVICE LABOR: Runco will pay for service labor by Runco Authorized Service Center when needed as a result of manufacturing defect for a period of two (2) years from the effective date of delivery to the end user (excluding the lamp).

PARTS (not including the lamp): Runco will provide new or rebuilt replacement parts for the parts that fail due to defects in materials or workmanship for a period of two (2) years from the effective date of delivery to the end user. Such replacement parts are then subsequently warranted for the remaining portion (if any) of the original warranty period.

PROJECTOR LAMP: Runco will pay for service labor by a Runco Authorized Service Center when needed as a result of a manufacturing defect for a period of six (6) months or 1000 hours, whichever comes first, from the effective date of delivery to the end user. In addition, Runco will provide a new or rebuilt replacement lamp for the lamp that fails due to defects in materials or workmanship for a period of six (6) months or 1000 hours, whichever comes first, from the effective date of delivery to the end user. Such replacement lamps are then subsequently warranted for the remaining portion (if any) of the original warranty period.

WHAT IS NOT COVERED UNDER THE TERMS OF THIS LIMITED WARRANTY:

This Limited Warranty only covers failure due to defects in materials and workmanship that occur during normal use and does not cover normal maintenance. This Limited Warranty does not cover cabinets or any appearance items; failure resulting from accident, misuse, abuse, neglect, mishandling, misapplication, faulty or improper installation or setup adjustments; improper maintenance, alteration, improper use of any input signal; damage due to lightning or power line surges, spikes and brownouts; damage that occurs during shipping or transit; or damage that is attributed to acts of God. In the case of remote control units, damage resulting from leaking, old, damaged or improper batteries is also excluded from coverage under this Limited Warranty.

CAUTION: THIS LIMITED WARRANTY ONLY COVERS VIDIKRON PRODUCTS PURCHASED FROM VIDIKRON AUTHORIZED DEALERS. ALL OTHER PRODUCTS ARE SPECIFICALLY EXCLUDED FROM COVERAGE UNDER THIS WARRANTY. MOREOVER, DAMAGE RESULTING DIRECTLY OR INDIRECTLY FROM IMPROPER INSTALLATION OR SETUP IS SPECIFICALLY EXCLUDED FROM COVERAGE UNDER THIS LIMITED WARRANTY. IT IS IMPERATIVE THAT INSTALLATION AND SETUP WORK BE PERFORMED ONLY BY AN AUTHORIZED VIDIKRON DEALER TO PROTECT YOUR RIGHTS UNDER THIS WARRANTY. THIS WILL ALSO ENSURE THAT YOU ENJOY THE FINE PERFORMANCE OF WHICH YOUR VIDIKRON PRODUCT IS CAPABLE WHEN INSTALLED AND CALIBRATED BY VIDIKRON AUTHORIZED PERSONNEL.

RIGHTS, LIMITS AND EXCLUSIONS:

Runco limits its obligations under any implied warranties under state laws to a period not to exceed the warranty period. There are no express warranties. Runco also excludes any obligation on its part for incidental or consequential damages related to the failure of this product to function properly. Some states do not allow limitations on how long an implied warranty lasts, and some states do not allow the exclusion or limitation of incidental or consequential damages. So the above limitations or exclusions may not apply to you. This warranty gives you specific legal rights, and you may also have other rights that vary from state to state.

EFFECTIVE WARRANTY DATE:

This warranty begins on the effective date of delivery to the end user. For your convenience, keep the original bill of sale as evidence of the purchase date.

IMPORTANT -- WARRANTY REGISTRATION:

Please fill out and mail your warranty registration card. It is imperative that Runco knows how to reach you promptly if we should discover a safety problem or product update for which you must be notified.

CONTACT A VIDIKRON AUTHORIZED SERVICE CENTER TO OBTAIN SERVICE:

Repairs made under the terms of this Limited Warranty covering your Runco video product will be performed at the location of the product, during usual working hours, providing location of product is within normal operating distance from a Runco Authorized Service Center. In some instances it may be necessary for the product to be returned to the Runco factory for repairs. If, solely in Runco's judgment, location of product to be repaired is beyond normal operating distance of the closest Runco Authorized Service Center, or the repair requires the unit be returned to the Runco factory, it is the owner's responsibility to arrange for shipment of the product for repair. These arrangements must be made through the selling Runco Dealer. If this is not possible, contact Runco directly for a Return Authorization number and shipping instructions. Runco will return product transportation prepaid in the United States, unless no product defect is discovered. In that instance, shipping costs will be the responsibility of the owner.

COPYRIGHT AND TRADEMARKS:

© Copyright 2006 Runco International. This document contains proprietary information protected by copyright, trademark and other intellectual property laws. All rights are reserved. No part of this manual may be reproduced by any mechanical, electronic or other means, in any form, without prior written permission of the manufacturer.

Reflection, Enhanced GEN3, DHD, Vivix, Virtual Cinema, CineWide, AutoScope, O-Path, CinOptx, LiveLink, CSMS, SuperOnyx and VirtualWide are trademarks of Runco International.

All other trademarks and registered trademarks used in this document are the property of their respective owners.

Runco International products are manufactured under one or more of the following patents: US. Patent 6755540 and Other Patents Pending.

ADDITIONAL INFORMATION:

To locate the name and address of the nearest Runco Authorized Service Center, or for additional information about this Limited Warranty, please call or write:

RUNCO INTERNATIONAL, INC.
Attn: Customer Service Department
2900 Faber Street
Union City, CA 94587
Ph: (510) 324-7777
Fax: (510) 324-9300
Toll Free: (800) 23-RUNCO

RUNCO VIDEO-PRODUCT INFORMATION
RETAIN THIS INFORMATION FOR YOUR RECORDS

Model Purchased

Date

Serial Number

Runco Authorized Dealer Name

Address

City

State/Province

Postal Code

Phone

Fax

Safety Precautions

Thank you for your purchase of this quality Runco video projector! It has been designed to provide you with the quality of video that is expected in a home theater. For the best performance, please read this manual carefully as it is your guide through the menus and operation.

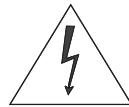
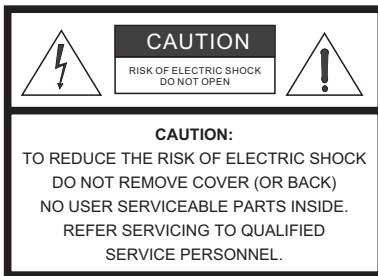

WARNING

This symbol is intended to alert the user to the presence of uninsulated “dangerous voltage” within the product’s enclosure that may be of sufficient magnitude to constitute a risk of electric shock.



This symbol is intended to alert the user to the presence of important operating and maintenance (servicing) instructions in the literature accompanying the appliance.

This equipment has been tested and found to comply with the limits for a Class B digital device, pursuant to Part 15 of the FCC Rules. These limits are designed to provide reasonable protection against harmful interference in a residential installation.

1. Read these instructions.
2. Keep these instructions.
3. Heed all warnings.
4. Do not use this equipment near water, outdoors or otherwise exposed to the elements.
5. Clean only with a dry cloth.
6. Do not block any ventilation openings.
7. Do not install near any heat sources such as radiators, heat registers, stoves, or other apparatus (including amplifiers) that produce heat.
8. Do not defeat the safety feature of the polarized or grounding type plug. A polarized type plug has two blades with one wider than the other. A grounding type plug has two blades and a third grounding prong. The third prong is provided for your safety. If the provided plug does not fit into your outlet, consult an electrician for the replacement of the obsolete outlet.
9. The 12V trigger only outputs DC 12V signal for triggering. Do not connect to any other power input or output. This could cause damage to this unit.
10. Only use accessories specified by Runco International.
11. Keep the packing material in case the equipment should ever need to be shipped.
12. Unplug this projector during lightning storms or when it will not be used for an extended period of time.
13. The lamp becomes extremely hot during operation. Allow the projector to cool down for approximately 45 minutes prior to removing the lamp assembly for replacement. Do not operate lamps beyond the rated lamp life. Excessive operation of lamps beyond rated life could cause them to explode in rare occasions.
14. Refer all servicing to qualified service personnel. Servicing is required when the projector has been damaged in any way, objects have fallen or spilled into the projector, the projector has been exposed to rain or moisture, does not operate normally, or has been dropped.

Table of Contents

TWO YEAR LIMITED WARRANTY	iii
Safety Precautions	vi
1. Introduction	1
About This Manual	1
Target Audience	1
If You Have Comments About This Manual.....	1
Textual and Graphic Conventions	1
Using This Manual	2
Description, Features and Benefits	3
Key Features and Benefits	4
Parts List	4
2. Controls and Functions	5
CL-610 at a Glance	5
Front/Side/Top View	5
Rear/Side/Bottom View	6
Lens Controls and Status Indicators	7
CL-610 Connector Panel	8
CL-610 Remote Control	10
3. Installation	13
Remote Control	13
Notes on Batteries	13
Notes on Remote Control Operation.....	13
Quick Setup	14
Installation Considerations	15
Installation Type.....	15
Ambient Light	15
Throw Distance.....	16
Vertical and Horizontal Position.....	17
Folded Optics	17
Other Considerations.....	18

Mounting the CL-610	18
Floor Mounting (Upright)	18
Ceiling Mounting (Inverted).....	18
Adjusting the Projector Height or Projection Angle	18
Connections to the CL-610	19
Connector Panel Access.....	19
Connecting Source Components to the CL-610	19
RS-232 Controller Connection	23
Connecting 12-volt Trigger Output to External Theater Equipment.....	24
Connecting to AC Power	24
Turning On the Power	25
Changing the OSD Language	25
Adjusting the Picture Orientation	25
Zoom and Focus Adjustments	25
Installing and Adjusting the CineWide Anamorphic Lens	26
Remove the Projector Front Jewelry	26
Installing the Anamorphic Lens	26
Adjusting the Anamorphic Lens	27
4. Operation	29
Selecting Video Memory	29
Selecting an Aspect Ratio	29
Selecting An Input Source	29
Using Picture-In-Picture and Picture-By-Picture (PIP/PBP)	29
Turning Off the Power	30
Using the On-Screen Menus	30
Main Menu.....	32
Picture Adjustment	32
Aspect Ratio	37
Installation.....	40
Option	40
Set Up.....	42
ISF Calibration	46
5. Maintenance and Troubleshooting	49
Lamp Replacement	49
Troubleshooting Tips	50

6. Serial Communications	53
RS-232 Connection and Port Configuration	53
Serial Command Syntax	53
7. Specifications	57
CL-610 Specifications	57
CL-610 Dimensions	59
APPENDIX A. Personalizing the ISF Splash Screen on the CL-610	A-1

Notes:

List of Figures

2-1. CL-610 Front/Side/Top View	5
2-2. CL-610 Rear/Bottom/Side View	6
2-3. CL-610 Lens Controls and Status Indicators	7
2-4. CL-610 Connector Panel.....	8
2-5. CL-610 Remote Control	10
3-1. Estimating Throw Distance	16
3-2. Projector Placement	17
3-3. Folded Optics.....	17
3-4. HDMI/DVI Source Connections	19
3-5. RGB Connections	20
3-6. Progressive Component Video Connections.....	21
3-7. Composite, S-Video and Component Video Connections.....	22
3-8. RS-232 Control System Connection.....	23
3-9. Connecting the 12-Volt Trigger Output to Other Equipment.....	24
3-10. Anamorphic Lens Mounting Assembly - Exploded View	26
4-1. CL-610 OSD Menu Structure	31
4-2. Typical PLUGE Pattern for Adjusting Brightness	33
4-3. Typical Gray Bar Pattern for Adjusting Contrast	34
4-4. Typical Color Bar Pattern for Adjusting Color Saturation and Tint.....	34
4-5. Typical Test Pattern for Adjusting Sharpness	36
7-1. CL-610 Dimensions.....	59

Notes:

1. Introduction

This Owner's Manual describes how to install, set up and operate the Runco Reflection CL-610 family of Digital Light Processing™ Projectors:

- CL-610
- CL-610LT (Long Throw)
- CL-610/CineWide™
- CL-610LT/CineWide

Throughout this manual, all four projector models are referred to collectively as the "CL-610." Except where noted, the features and functions described in this manual are common to all versions of this product.

Runco has prepared this manual to help home theater installers and end users get the most out of the CL-610.

Runco has made every effort to ensure that this manual is accurate as of the date it was printed. However, because of ongoing product improvements and customer feedback, it may require updating from time to time. You can always find the latest version of this and other Runco product manuals on-line, at www.Runco.com.

Runco welcomes your comments about this manual. Send them to info@vidikron.com.

Text Conventions: The following conventions are used in this manual, in order to clarify the information and instructions provided:

- Remote and built-in keypad button identifiers are set in upper-case bold type; for example, "Press **EXIT** to return to the previous menu."
- Computer input (commands you type) and output (responses that appear on-screen) is shown in monospace (fixed-width) type; for example: "To change the aspect ratio to Letterbox, type x063x **<Enter>**."
- All keys with functional names are initial-capped, set in bold type and enclosed in angle brackets. These keys are the following: **<Enter>**, **<Spacebar>**, **<Control>**, **<Esc>** and **<Tab>**.
- **<Enter>** indicates that you may press either the RETURN or ENTER key on your keyboard if it has both keys.

In addition to these conventions, underlining, boldface and/or italics are occasionally used to highlight important information, as in this example:



Note

*A carriage return **must** be used after each command or string.*

1.1 About This Manual

◀ Target Audience

◀ If You Have Comments About This Manual...

◀ Textual and Graphic Conventions

Graphic Conventions: These symbols appear in numerous places throughout the manual, to emphasize points that you must keep in mind to avoid problems with your equipment or injury:



Tip

TIPS highlight time-saving short cuts and helpful guidelines for using certain features.



Note

NOTES emphasize text with unusual importance or special significance. They also provide supplemental information.



Caution

CAUTIONS alert users that a given action or omitted action can degrade performance or cause a malfunction.



WARNING

WARNINGS appear when a given action or omitted action can result in damage to the equipment, or possible non-fatal injury to the user.



DANGER!

DANGER appears when a given action can cause severe injury or death.

1.2 Using This Manual

Use the following table to locate the specific information you need in this manual.

If you need...	... Turn to page:
Information about obtaining service	iv
General information about the CL-610 Series DLP Projectors	3
Installation instructions	13
First-time configuration instructions	25
Advanced configuration instructions	42
Troubleshooting tips	50
Specifications for the CL-610 Series DLP Projectors	57

The CL-610 Series DLP Projectors offer the astounding picture quality and versatility heretofore associated with more expensive projectors. Their 1280 x 720 native resolution DLP light engine incorporates all-new technology for bright, pristine high-definition images.

With throw distances of 1.37 – 1.82:1 on the CL-610 and 1.87 – 2.47:1 on the longer-throw CL-610LT, both units offer the performance and installation flexibility custom home theater enthusiasts have come to expect from Runco — all at a superb price and packaged with outstanding build quality.

Advanced Runco Vivix™ digital video processing is engineered into these all-new projection systems to achieve improved image quality even from standard video sources, in addition to artifact-free scaling of higher resolution formats.

The CL-610's illumination system incorporates Runco's exclusive Selectable Lamp Intensity Control™ (SLIC™), which provides two light intensity levels to allow maximum flexibility for screen size, ambient light conditions, brightness and contrast balance, and lamp life preservation. It also has a newly-refined cooling system, which increases efficiency and reduces noise levels.

The CL-610 has been engineered to comply with Imaging Science Foundation™ (ISF) standards for maximum home theater image quality. Runco's sophisticated parameters for white balance and color gamut control have also been implemented for precise balance of gray scale and color.

For uncompromising widescreen reproduction of movies originally filmed in the “scope” (2.35:1) format, the CL-610 can be equipped with Runco's patent-pending CineWide™ technology, a combination of software, electronics and high-quality anamorphic optics. CineWide maintains constant vertical height on the screen just as in a movie theater. When a viewer transitions from 1.78:1 (16:9) program material to 2.35:1, the image simply gets wider while full height is maintained.

**Note**

CineWide requires the use of a 2.35:1 or similar aspect ratio superwide format screen.

Discrete IR and RS-232 control make custom installation seamless, while discrete source and aspect ratio selection accommodate any automation control system.

1.3 Description, Features and Benefits

- Key Features and Benefits** ➤ The CL-610 offers these key features and benefits:
- Native Resolution: 1280 x 720 (16:9 Native Aspect Ratio)
 - DLP system using high-performance Digital Micromirror Device (DMD)
 - 6-segment, 5x color wheel produces wide dynamic range and rich grayscale
 - Picture in Picture / Picture by Picture functions allow you to display two inputs on the screen at the same time
 - HDMI Input with High-bandwidth Digital Content Protection (HDCP)
 - HDTV Compatible

- Parts List** ➤ Your CL-610 is shipped with the following items. If any items are missing or damaged, please contact your Runco dealer or Runco Customer Service at (800) 23RUNCO.
- CL-610 DLP Projector
 - Remote Control Unit and two (2), AAA-size batteries
 - AC Power Cords (North America, Europe, Asia)
 - Source Connection Cables:
 - Composite Video
 - S-Video
 - Component Video
 - RGB (DB15HD-to-5 x BNC)
 - HDMI to HDMI
 - HDMI to DVI
 - Warranty information and registration card
 - Runco CL-610 Series Owner's Operating Manual (this document)

Optional Accessories:

- CineWide™ technology (secondary anamorphic lens and motorized mount)
- Ceiling mount kit

2. Controls and Functions

Figure 2-1 and Figure 2-2 show the key CL-610 components.

2.1 CL-610 at a Glance

◀ *Front/Side/Top View*

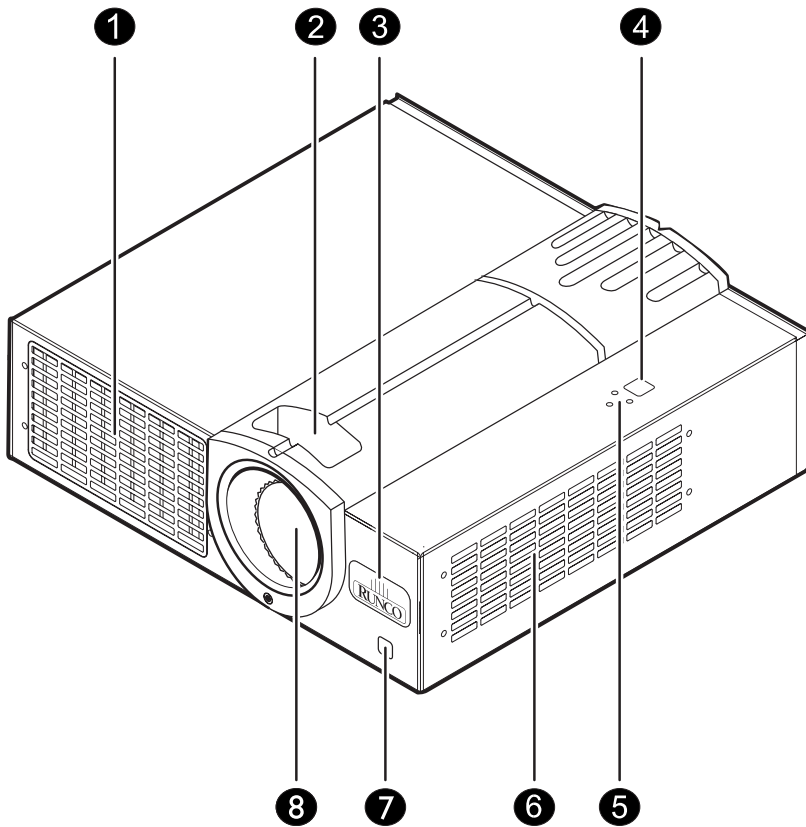

Figure 2-1. CL-610 Front/Side/Top View

1. **EXHAUST VENT**
2. **FOCUS RING / ZOOM RING ACCESS**
Adjust the size and focus of the image.
3. **RUNCO LOGO**
The logo can be rotated to match the projector orientation: inverted (ceiling-mounted) or upright. To rotate the logo, grip it at the sides, pull it away from the projector and rotate it 180 degrees.
4. **TOP IR SENSOR**
5. **STATUS LEDs**
Refer to **Lens Controls and Status Indicators** on page 7 for more information.

6. **INTAKE VENT**
7. **FRONT IR SENSOR**
8. **PROJECTION LENS**

Rear/Side/Bottom View ➤

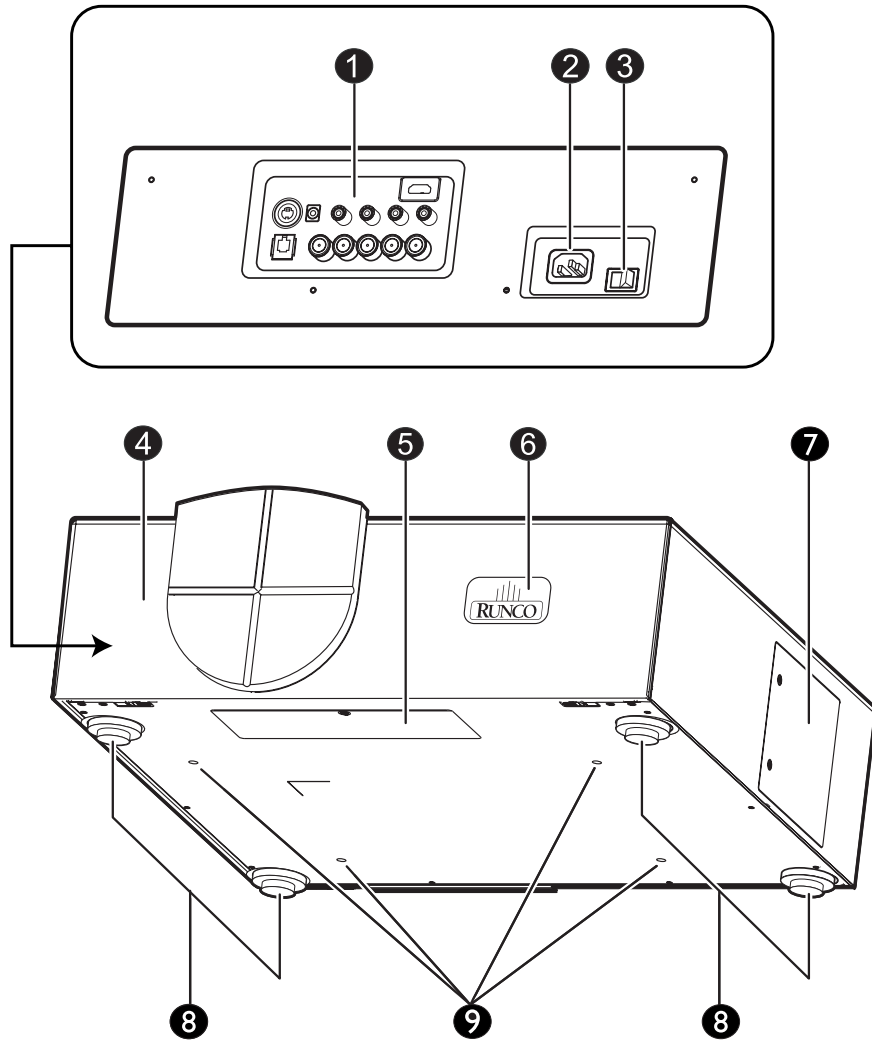

Figure 2-2. CL-610 Rear/Bottom/Side View

1. **CONNECTOR PANEL**
Refer to **CL-610 Connector Panel** on page 8 for more information.
2. **AC POWER INPUT (100 to 240 VAC)**
Connect the CL-610 to power here.
3. **AC POWER SWITCH**
Disconnects or applies power to the CL-610.
4. **CABLE ACCESS DOOR**
Open to access connectors.
5. **CABLE OPENING**
Pass cables through this opening.

6. **RUNCO LOGO**
The logo can be rotated to match the projector orientation: inverted (ceiling-mounted) or upright. To rotate the logo, grip it at the sides, pull it away from the projector and rotate it 180 degrees.
7. **LAMP MODULE COVER**
Remove this cover to access the lamp compartment.
8. **FRONT/REAR ADJUSTERS**
Use these to adjust the projector height or projection angle.
9. **CEILING MOUNT HOLES**
Use these to attach the ceiling bracket to the projector.

Figure 2-4 shows the CL-610 lens controls and status indicator LEDs. .

2.2 Lens Controls and Status Indicators

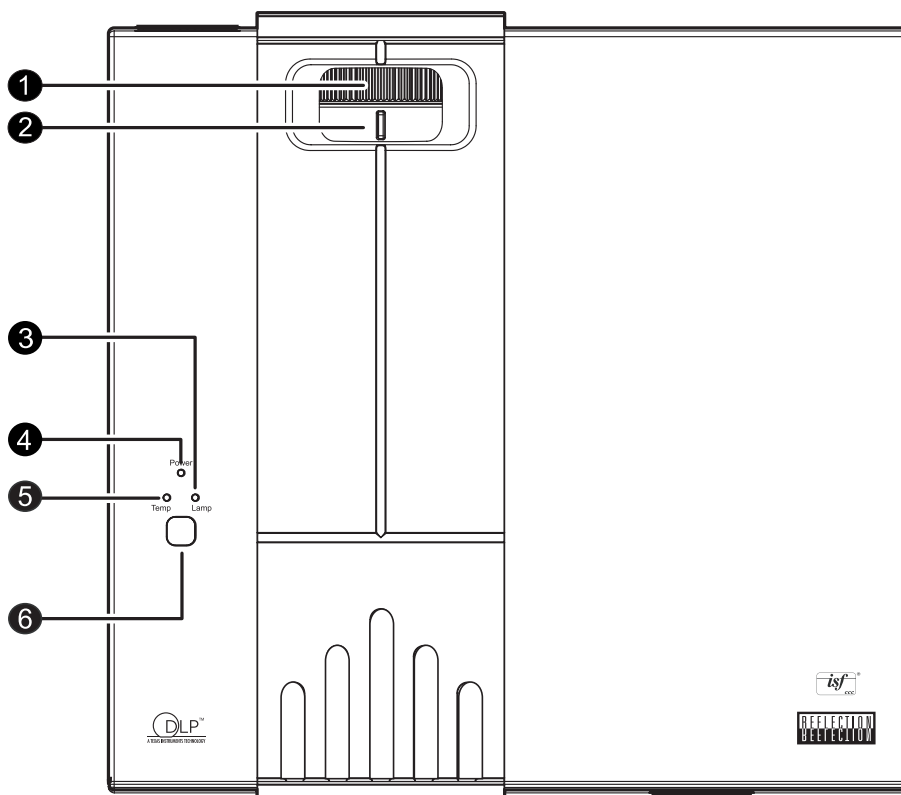
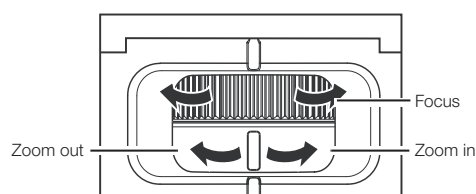

Figure 2-3. CL-610 Lens Controls and Status Indicators

1. **FOCUS RING**
Rotate the ring to focus the projected image.
2. **ZOOM RING**
Rotate the ring to adjust the projected image size.



3. **LAMP LED**

Indicates lamp status as follows:

- Off during normal operation
- Red when the lamp has exceeded its usage life or developed a problem
- Flashes red when the fans are not working or the lamp cover is open

4. **POWER/STANDBY LED**

Indicates power status as follows:

- Orange when the projector is in standby mode
- Flashes orange for 45 seconds after the projector is turned on to indicate that the lamp is warming up
- Green during normal operation
- Flashes green for 110 seconds after the projector is turned off to indicate that the lamp is cooling down

5. **TEMP LED**

Indicates fan status and internal temperature as follows:

- Off during normal operation
- Red when internal temperature is too high
- Flashes red when the fans are not working or the lamp cover is open

**2.3
CL-610 Connector
Panel**

Figure 2-4 shows the CL-610 connector panel.

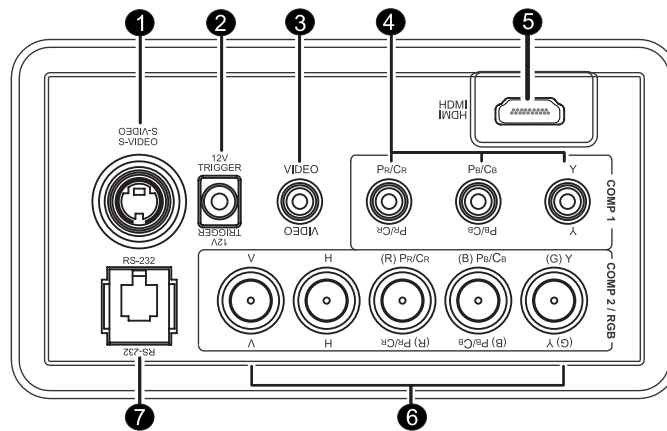

Figure 2-4. CL-610 Connector Panel

1. **S-VIDEO**
A standard S-Video input for connecting a DVD player, satellite receiver or Super VHS (S-VHS) VCR.
2. **12-VOLT (250 mA) TRIGGER OUTPUT (3.5-mm, mini phono jack)**
Connection for 12-volt trigger-activated equipment such as retractable screens or screen masking.
3. **COMPOSITE VIDEO INPUT**
Standard composite video input for connecting a VCR, laser disc player or other composite video source.
4. **COMP 1 (RCA connectors)**
Standard Definition (480i/576i) Component (YPrPb) input. This is the input for component video from sources such as DVD players.
5. **HDMI (Digital)**
HDCP-compliant digital video input for connecting a DVD player or HD tuner with a DVI or HDMI output.

**Tip**

For best results, do not run your DVD player in progressive mode.

6. **COMP 2 / RGB**
Five (5) BNCs for connecting either RGB or component (YPbPr) high-definition television signals. (The CL-610 automatically detects the signal format.)
7. **RS-232 CONTROL PORT**
A female, RJ-11 connector for interfacing with a PC or home theater automation/control system.

2.4 CL-610 Remote Control

Figure 2-5 shows the CL-610 remote control, and the paragraphs that follow describe its functionality.

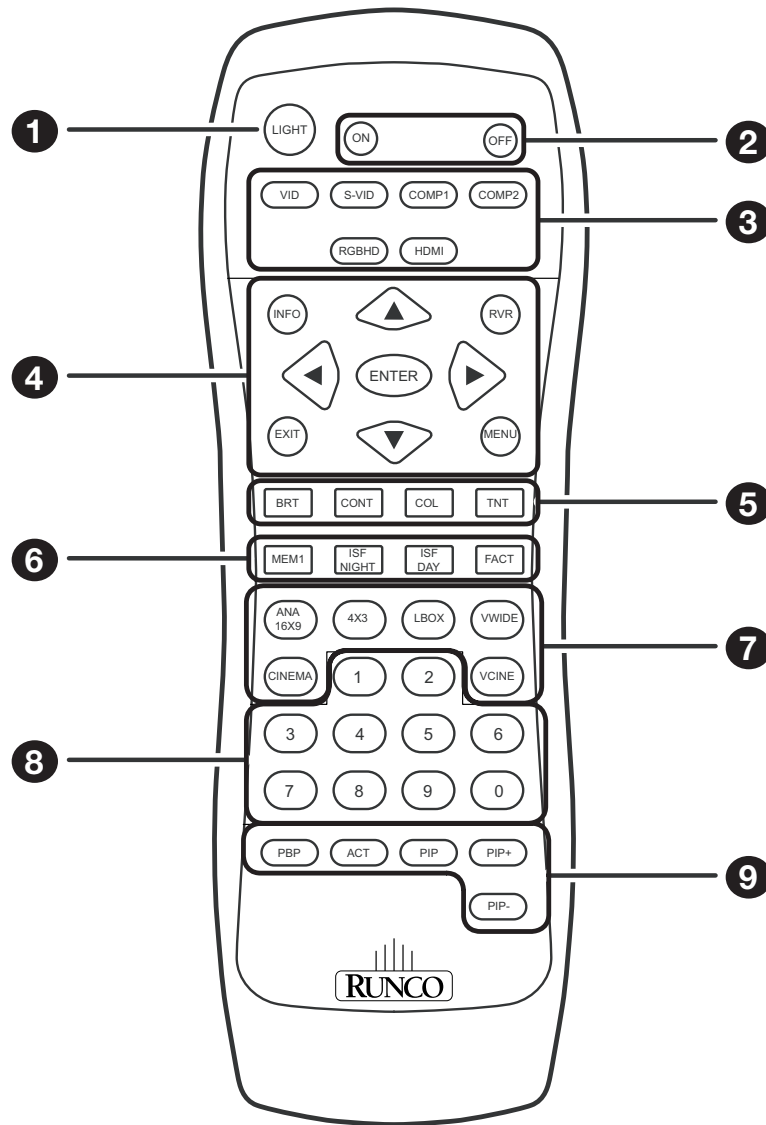

Figure 2-5. CL-610 Remote Control

1. **LIGHT**
Press to illuminate the buttons.
2. **ON / OFF**
Use these buttons to turn the projector on or off.

3. **Source Selection Buttons:**

VID

Press to select Composite video input as the source.

S-VID (S-Video)

Press to select the S-Video input as the source.

COMP1 (SD Component)

Press to select Component 1 (SD 480i/576i) video input as the source.

COMP2 (HD Component)

Press to select Component 2 (HD 480p/576p/720p/1080i) video input as the source.

RGBHD

Press to select the Component 2 RGB input.

HDMI

Press to select the HDMI input.

4. **INFO**

Displays active source and aspect ratio information.

Cursor Keys (▲, ◀, ▼, ▶)

Use these buttons to select items or settings, adjust settings or switch display patterns.

RVR

Not applicable to this projector.

EXIT

Press to save menu item setting(s), exit the current menu and return to the previous one.

ENTER

Press to select a highlighted menu item or confirm a changed setting.

MENU

Press this button to show or hide the on-screen display (OSD) controls.

5. **Picture Adjustment Buttons:**

BRT (Brightness)

Press to adjust black level.

CONT (Contrast)

Press to adjust white level.

COL (Color)

Press to adjust color intensity.

TNT (Tint)

Press to adjust color hues.

6. **Memory Preset Buttons:**

MEM1

Press to recall settings for the current input from the "Memory 1" memory preset.

ISF NIGHT

Press to recall settings for the current input from the "ISF Night" memory preset.

ISF DAY

Press to recall settings for the current input from the "ISF Day" memory preset.

FACT

Press to recall the factory-default settings for the current input.

7. **Aspect Ratio Selection Buttons**

Use these buttons to select an aspect ratio directly, as follows:

ANA 16:9 (Anamorphic)

For viewing 16:9 DVDs or HDTV programs in their native aspect ratio.

4X3 (Standard 4:3)

Scales the input signal to fit 4:3 display mode in the center of the screen.

LBOX (Letterbox)

For viewing LaserDisc movies or non-anamorphic DVDs on a 16:9 screen.

VWIDE (VirtualWide)

Enlarges a 4:3 image horizontally in a NON-linear fashion to fit 16:9 full screen display.

CINEMA

For viewing 2.35:1 source material.

VCINE (CL-610/CineWide and CL-610LT/CineWide only)

Selects the Virtualwide 2.35 aspect ratio, used for viewing 16:9 source material on a 2.35:1 screen.

8. **0 - 9**

Use these keys to enter menu passcodes.

9. **Picture-In-Picture (PIP) / Picture-By-Picture (PBP) Controls:**

PBP

Press to activate PBP mode.

ACT

Press to switch to the active window in PIP or PBP mode.

PIP

Press to activate PIP mode.

PIP+

Press to enlarge the PIP window.

PIP-

Press to shrink the size of the PIP window.

3. Installation

To install batteries in the remote control, push the battery cover and slide it off. Install the two AAA batteries with the correct polarity and then replace the cover.

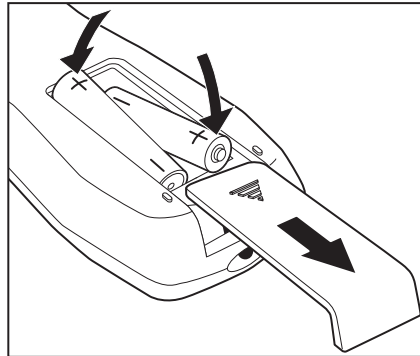

3.1 Remote Control

- Make sure that the battery polarities are correct when installing the batteries.
- Do not mix an old battery with a new one or different types of batteries.
- If you will not use the remote control for a long time, remove the batteries to avoid damage from battery leakage.
- Make sure that there is nothing obstructing the infrared beam between the remote control and the IR receiver on the projector.
- If the effective range of the remote control decreases, or it stops working, replace the batteries with new ones.
- The remote control may fail to operate if the infrared remote sensor is exposed to bright sunlight or fluorescent lighting.
- Ambient conditions may possibly impede the operation of the remote control. If this happens, point the remote control at the projector, and repeat the operation.
- The Ø icon appears on the screen when you press a button for an unavailable function.

◀ Notes on Batteries

◀ Notes on Remote Control Operation

3.2 Quick Setup

Table 3-1 gives a quick overview of the CL-610 installation process. The sections following this one provide detailed instructions.



Note

Installation should be performed by a qualified custom video installation specialist.

Table 3-1. Installation Overview

Step	Procedure	For Details, Refer to page...
1	Choose a location for the projector	15
2	Mount the projector	18
3	Connect signal sources to the CL-610	19
4	Connect external controller to RS-232 port (optional)	23
5	Connect 12-volt trigger output to retractable screen or other, +12-volt trigger-activated equipment (optional)	24
6	Apply power to the projector	24
7	Change the OSD Language (optional)	25
8	For rear-screen and/or ceiling-mount installations, select the proper picture orientation	25
9	Primary lens adjustments: projected image size (zoom) and focus	25
10	Install CineWide anamorphic lens (CL-610/CineWide and CL-610LT/CineWide only)	26
11	CineWide lens adjustments: position, angle, geometry and focus	27
12	Projector calibration: adjust the following for each input; save settings when finished: <ul style="list-style-type: none"> • Aspect ratio • Brightness • Contrast • Color level • Tint • Input position 	37 through 43

Proper installation of your projector will ensure the quality of your display. Whether you are installing a projector temporarily or permanently, you should take the following into account to ensure your projector performs optimally.

Choose the installation type that best suits your needs: front or rear screen, floor mount or inverted mount. Table 3-2 compares these various installation methods.

Table 3-2. Projector Installation Options

Advantages	Considerations
Front Screen, Floor Mount Installation	
<ul style="list-style-type: none"> • Easy to set up • Can be moved or changed quickly • Easy to access 	<ul style="list-style-type: none"> • Shares floor space with audience
Front Screen, Inverted Mount (ceiling) Installation	
<ul style="list-style-type: none"> • Does not take up audience space • Projector is unobtrusive • Projector cannot be accidentally moved 	<ul style="list-style-type: none"> • Installation is more permanent • Projector access is more difficult
Rear Screen, Floor Mount Installation	
<ul style="list-style-type: none"> • Projector is completely hidden • Projector is easily accessed • Usually good ambient light rejection 	<ul style="list-style-type: none"> • Requires separate room • Installation cost is usually higher
Rear Screen, Inverted Mount (ceiling) Installation	
<ul style="list-style-type: none"> • Projector is completely hidden • Usually good ambient light rejection 	<ul style="list-style-type: none"> • Requires separate room • Installation cost is usually higher
Rear Screen, Floor Mount with Mirror	
<ul style="list-style-type: none"> • Projector is completely hidden • Usually good ambient light rejection • Requires less space behind screen than other rear screen installations 	<ul style="list-style-type: none"> • Requires separate room • Installation cost is usually higher

In general, minimize or eliminate light sources directed at the screen. Contrast ratio in your images will be noticeably reduced if light directly strikes the screen, such as when a shaft of light from a window or floodlight falls on the image. Images may then appear washed out and less vibrant.

3.3 Installation Considerations

◀ Installation Type

◀ Ambient Light

Throw Distance ➤ Throw distance is the distance measured from the front of the projector to the screen. This is an important calculation in any projector installation as it determines whether or not you have enough room to install your projector with a desired screen size and if your image will be the right size for your screen.

You can quickly estimate the throw distance by taking the width of the screen and multiplying it by the lens throw ratio; see Figure 3-1. The result of this calculation tells you roughly how far back the projector should be positioned from the screen in order to project a focused image large enough to fill the screen.

Estimating Throw Distance

Throw Distance (TD) = Screen Width (w) x Lens Throw Ratio

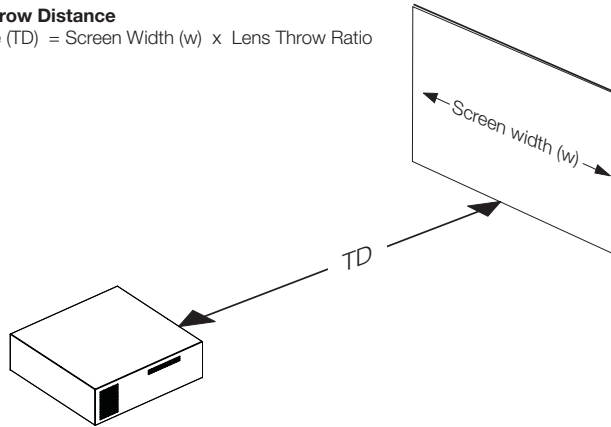

Figure 3-1. Estimating Throw Distance

Table 3-3 lists the throw ratios for the CL-610 Series.

Table 3-3. Throw Ratios for the CL-610 Series

Projector Model	Throw Ratio with Primary Lens Only	Throw Range in inches, with 72.6x40.8-inch (1.78:1) Screen		Throw Ratio with Primary Lens and Anamorphic Lens	Throw Range in inches, with 96x40.8-inch (2.35:1) Screen	
		Minimum	Maximum		Minimum	Maximum
CL-610	1.37 - 1.82	99.46	132.13		(n/a)	
CL-610/CineWide		(n/a)		1.55 - 1.82	148.80	174.72
CL-610LT	1.87 - 2.47	135.76	179.32		(n/a)	
CL-610LT/CineWide		(n/a)		1.87 - 2.47	179.52	237.12

Proper placement of the projector relative to the screen will yield a rectangular, perfectly-centered image that completely fills the screen.

Ideally, the projector should be positioned perpendicular to the screen and in such a way that the lens center is aligned with either the top or bottom edge of the screen area, and centered horizontally.

The top of the projected image is even with the lens center when the projector is inverted (ceiling-mounted). Likewise, the bottom of the projected image is aligned with the lens center when the projector is upright (as in a floor installation). See Figure 3-2.

◀ Vertical and Horizontal Position

Ceiling Installation

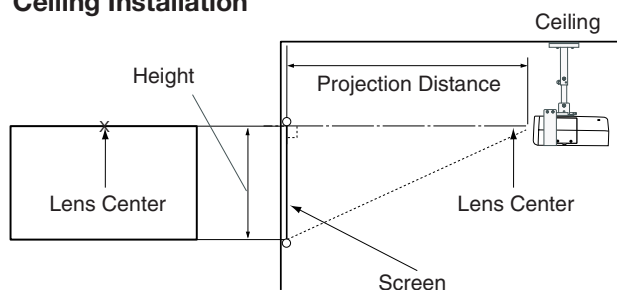

Floor Installation

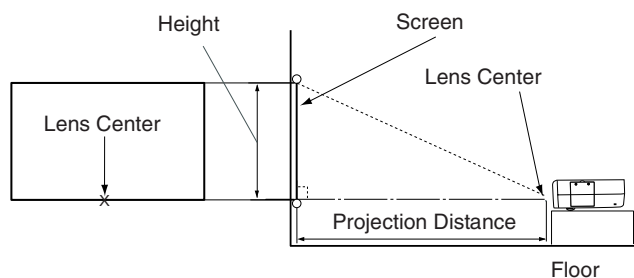

Figure 3-2. Projector Placement

In rear-screen applications where space behind the projector is limited, a mirror may be used to fold the optical path, as shown in Figure 3-3. The position of the projector and mirror must be accurately set. If you are considering this type of installation, contact your dealer for assistance.

◀ Folded Optics

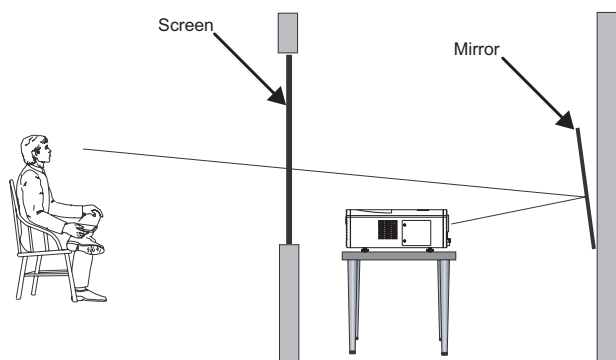

Figure 3-3. Folded Optics

Other Considerations ➤

Other considerations and tips that can help improve your installation:

- Keep the ambient temperature constant and below 35°C (95°F). Keep the projector away from heating and/or air conditioning vents. Changes in temperature may cause drifts in the projector circuitry, which may affect performance.
- Keep the projector away from devices that radiate electromagnetic energy such as motors and transformers. Common sources of these include slide projectors, speakers, power amplifiers and elevators.

3.4 Mounting the CL-610

There are several methods for mounting the projector. Depending on your chosen installation, one method may be more suitable than another.

Floor Mounting (Upright) ➤

In typical front and rear screen installations, the projector can be placed upright on a secure and level surface such as a table or cart. Carts are useful when moving a projector during a presentation or from site to site. If possible, lock the wheels when it's in position to prevent it from being moved during a presentation.

Ceiling Mounting (Inverted) ➤

For fixed installations, and for those that want the projector out of sight or have a limited space for projector and audience, you can invert the CL-610 and suspend it from the ceiling using a specially-designed ceiling mount fixture.

**Caution**

Use only the Runco-approved ceiling mount kit designed for your projector. Install the mount kit according to the instructions provided with it.

The projector can also be inverted and placed in an enclosure above and behind the viewing area. Install four feet on the inside bottom surface of the enclosure on which the projector can rest. A variety of materials can be used for this purpose (for example, rubber crutch tips or turntable feet).

Adjusting the Projector Height or Projection Angle ➤

If the screen is significantly higher or lower than the projector, you can also tilt the projector at a slight angle. In a ceiling installation, you do this by adjusting the ceiling mount.

For a floor installation, turn the four adjustable feet on the bottom of the projector to adjust the projector height and/or projection angle.

If you do this, you may need to make keystone adjustments or vertically shift the image using the on-screen display (OSD) controls, to compensate. For detailed instructions, refer to **Using the On-Screen Menus** on page 30.

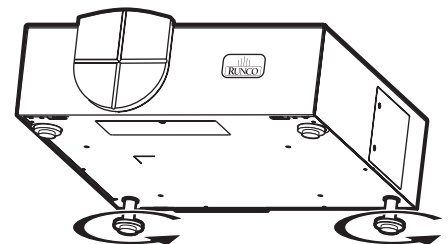

Proceed as follows to connect the CL-610 to your video sources, external controller(s) – if present – and AC power.

When connecting your equipment:

- Turn off all equipment before making any connections.
- Use the correct signal cables for each source.
- Ensure that the cables are securely connected. Tighten the thumbscrews on connectors that have them.

To access the connector panel, press the door release button so it pops out. Turn the knob clockwise or counter-clockwise and pull gently on it to open the door.

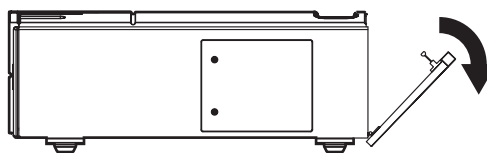

3.5 Connections to the CL-610

◀ Connector Panel Access

Connect your video sources to the CL-610 as shown and described in the sections that follow.

◀ Connecting Source Components to the CL-610

HDMI/DVI Connections: See Figure 3-4. With an HDMI source, use the included HDMI-to-HDMI cable; with a DVI source, use the included DVI-to-HDMI cable.



Tip

Use the HDMI input whenever possible. This ensures the highest video quality because the signal is carried in the digital domain throughout the entire signal path, from source component output into the projector.

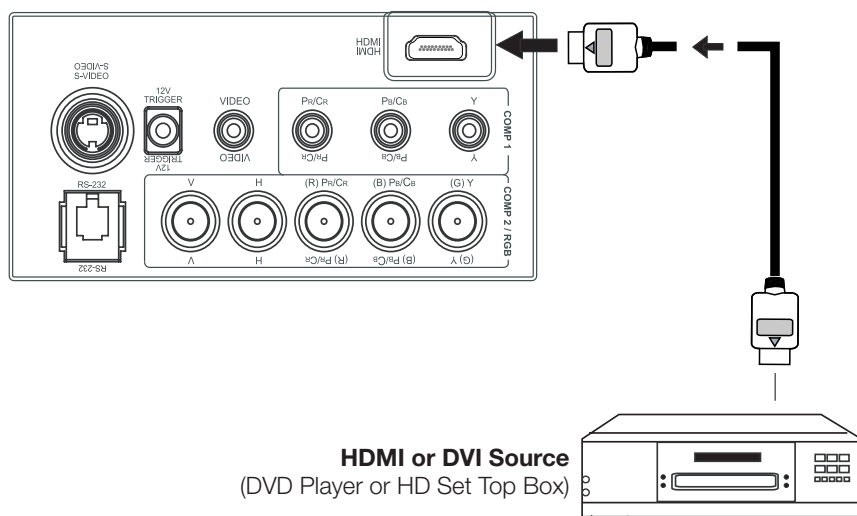

Figure 3-4. HDMI/DVI Source Connections

RGB Connections: Connect your personal computer or other RGB source (DVD player or HD set top box) to the **COMP 2/RGB** input; see Figure 3-5. You can use the included DB15HD-to-5 x BNC cable if your RGB source has a 15-pin, VGA-type connector.



Note

The CL-610 supports the following computer resolutions:
1024x768, 800x600 and 640x480.

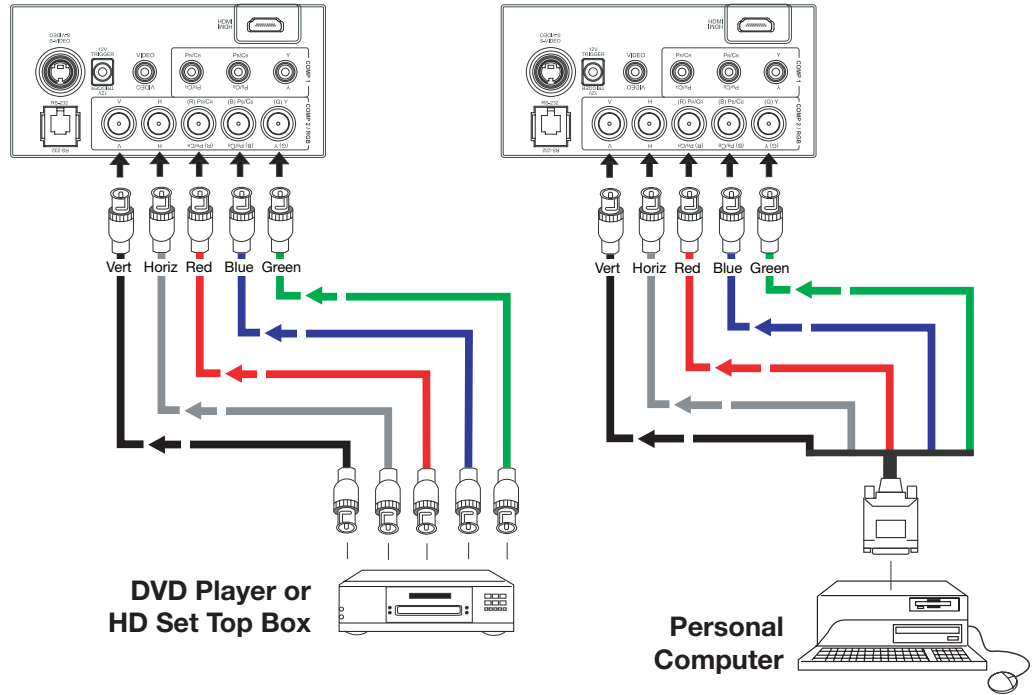

Figure 3-5. RGB Connections

Progressive Component Video Connections: Connect your progressive component source (DVD player or HD set top box) to the **COMP 2/RGB** input as shown in Figure 3-6.

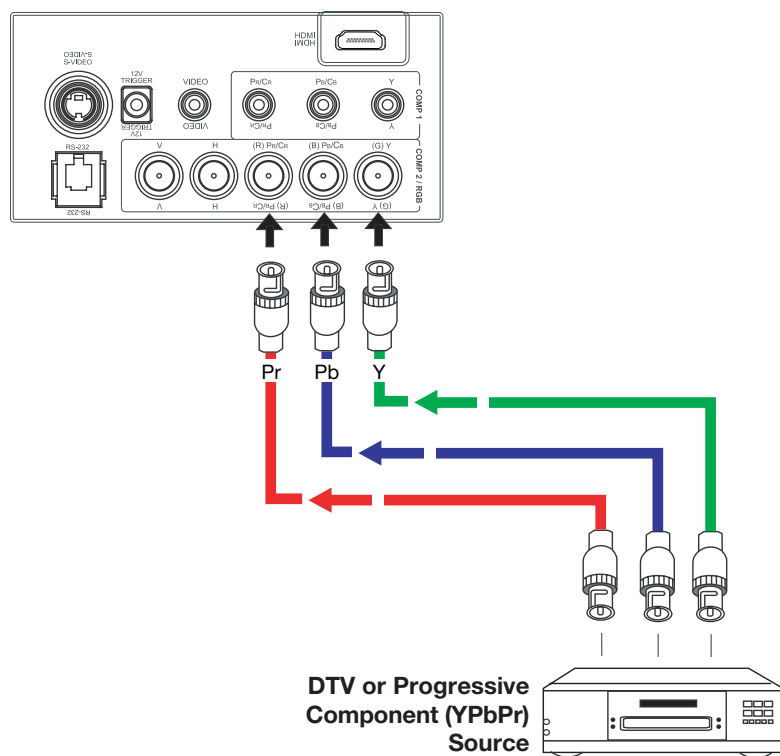

Figure 3-6. Progressive Component Video Connections

Composite/S-Video/Component Video Connections: Use the included cables to connect your composite, S-Video and SD (480i) component video sources to the CL-610 as shown in Figure 3-7.

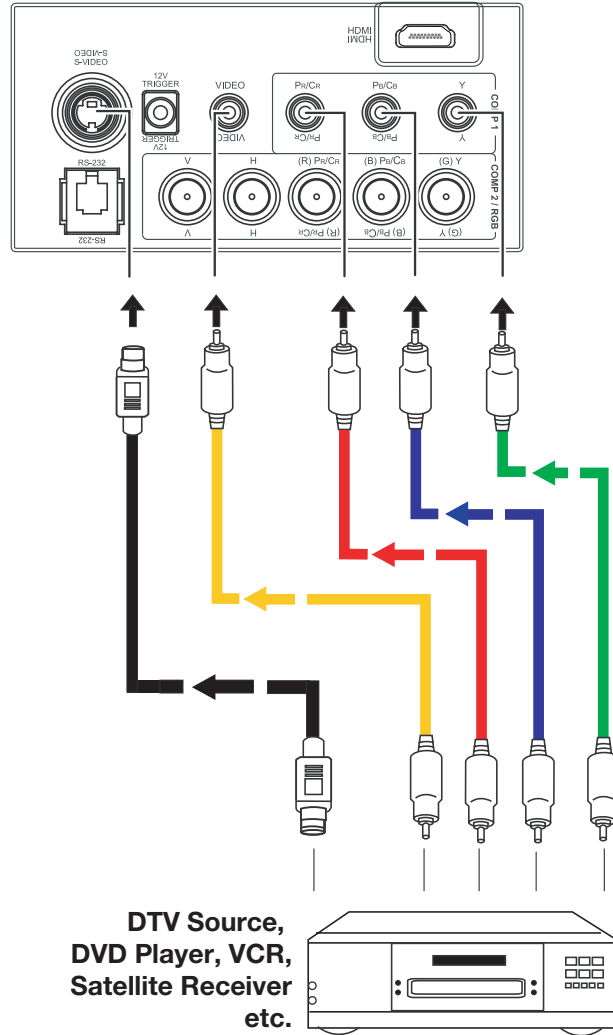
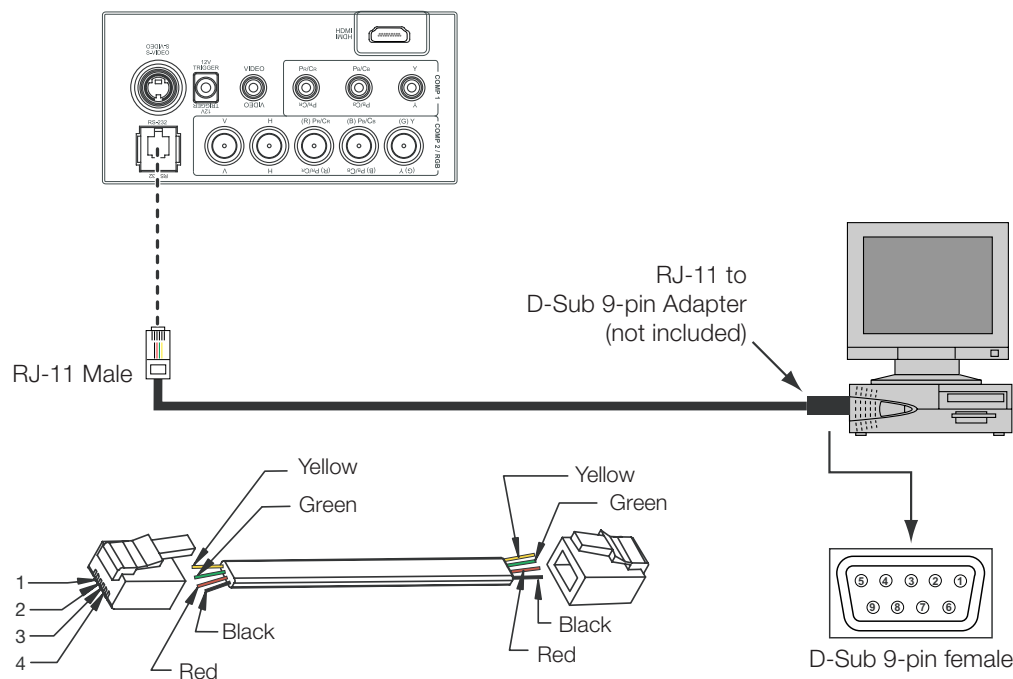

Figure 3-7. Composite, S-Video and Component Video Connections

Connect a PC or home theater control/automation system (if present) to the RS-232 port on the CL-610; see Figure 3-8. Use a standard, 4-wire RJ-11 telephone cable, wired straight-through.

◀ **RS-232 Controller Connection**

For more information about using this connection, refer to **Serial Communications** on page 53.



RS-232 Adapter Wiring		
D-Sub 9-pin female	4-pin RJ-11	Function
2	2	Transmit Data
3	3	Receive Data
5	1, 4	Ground
1, 4, 6, 7, 8, 9	--	Not Connected

Figure 3-8. RS-232 Control System Connection

Connecting 12-volt Trigger Output to External Theater Equipment

If your home theater contains a retractable screen, screen mask or other 12-volt trigger-activated equipment, use the cable supplied with the CL-610 to connect it to the 12-volt trigger output as shown in Figure 3-9.

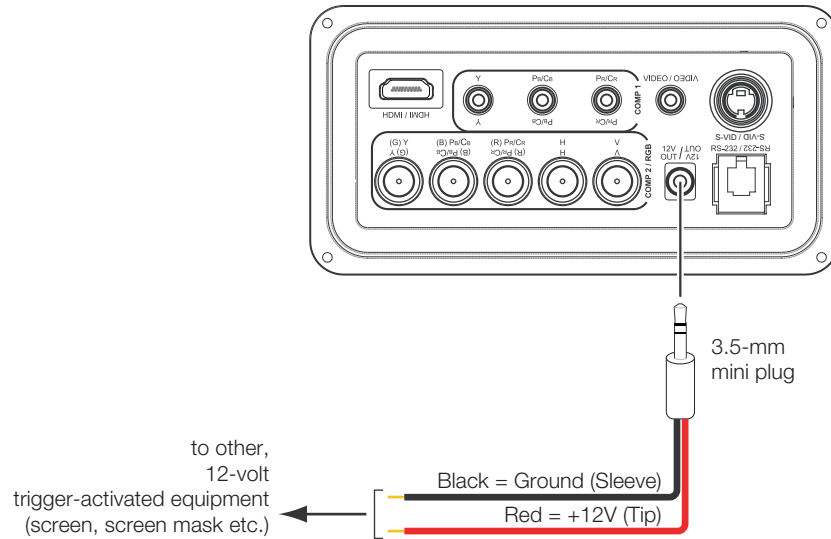
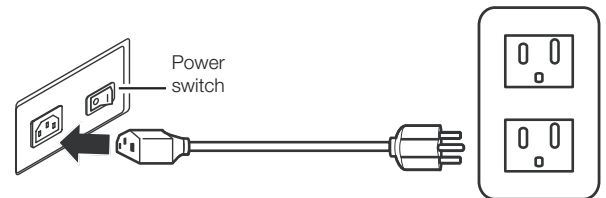

Figure 3-9. Connecting the 12-Volt Trigger Output to Other Equipment

Connecting to AC Power

The CL-610 ships with various types of AC power cords. Choose the one that is appropriate to your locale.

Plug the female end of the power cord into the AC receptacle on the rear of the projector (AC 100V ~ 240V). Then, connect the other end to your AC power source.



1. Turn on your source components.
2. Turn on the main power switch at the rear of the projector. The **POWER** LED lights orange. The **LAMP** and **TEMP** LEDs light red briefly, then go out.
3. Press the **ON** button on the remote control to turn on the CL-610. The **POWER** LED flashes orange to indicate that it is warming up.
4. When the projector is ready for use, the **POWER** LED lights green.
5. "Searching..." appears on the screen before the CL-610 identifies the input signal and remains there until a valid signal is detected.
6. If an incompatible input signal exceeds the range of the projector, a "No signal supported" message appears on the screen. This message remains on the screen until you change the input signal.

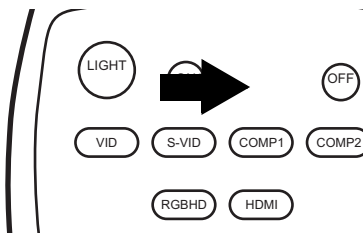

3.6 Turning On the Power

The CL-610 OSD language is initially set to English, but can also display the menus in French, Spanish, Italian or German. To change the OSD language:

1. Press **MENU**.
2. Select **Installation** from the Main Menu and press **ENTER**.
3. Select **Language** from the Installation Menu and press **ENTER**.
4. Press **▲** or **▼** to highlight the desired language. (The change takes effect immediately.)

3.7 Changing the OSD Language

By default, the CL-610 is configured for a "floor/front" installation, in which the projector is installed upright and in front of the screen. If it is installed behind the screen and/or mounted on a ceiling, you must change the picture orientation. To do this:

1. Press **MENU** on the remote control.
2. Select **Installation** from the Main Menu and press **ENTER**.
3. Select **Picture Orientation** from the Installation Menu and press **ENTER**.
4. Choose **Floor Rear**, **Ceiling Front** or **Ceiling Rear** to match the installation method.

3.8 Adjusting the Picture Orientation

The CL-610 gives you a great deal of control over the picture size and focus.

Adjust the projected image size with the zoom ring on the lens. To focus the image, rotate the focus ring on the lens.

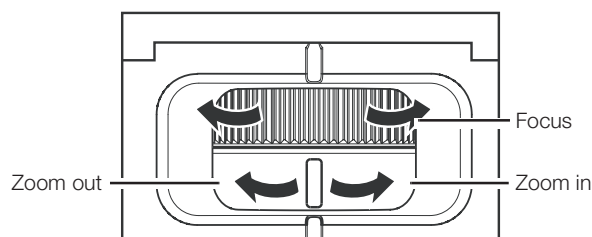

3.9 Zoom and Focus Adjustments

3.10 Installing and Adjusting the CineWide Anamorphic Lens

If you are installing a CineWide-equipped projector, proceed as follows to install and adjust the anamorphic lens.



Note

It is extremely important that the primary lens is properly adjusted before you install the anamorphic lens. Ensure that the image from the primary lens is perfectly centered on the screen.

The Anamorphic lens mount kit consists of everything shown in Figure 3-10. If any items are missing or damaged, please contact your Runco dealer or Runco Customer Service at (800) 23RUNCO.

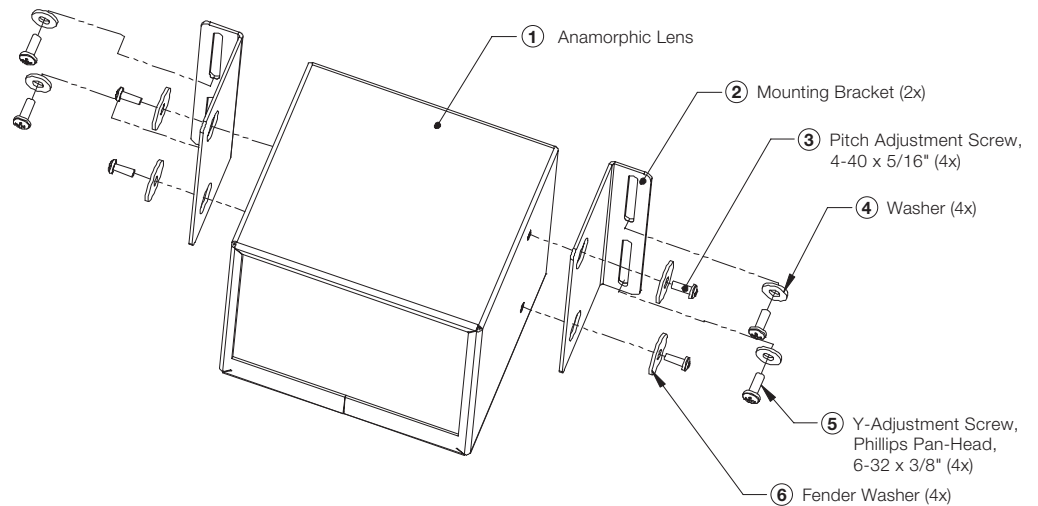

Figure 3-10. Anamorphic Lens Mounting Assembly - Exploded View

**Remove the Projector
Front Jewelry** ➤

Loosen the small Phillips screw (directly below the lens) holding the jewelry in place. Then, remove the jewelry.

**Installing the Anamorphic
Lens** ➤

1. Use the Pitch Adjustment Screws (item #3) and Washers (item #6) to attach the Mounting Brackets (item #2) to the Anamorphic Lens (item #1). (Do not fully tighten the screws yet.)
2. Use the four Y-Adjustment Screws (item #5) and Washers (item #4) to attach the Anamorphic Lens assembly to the front of the projector. (Again, do not fully tighten the screws yet.)

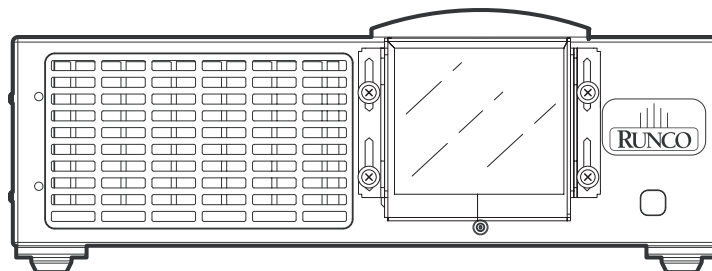

Height (Y) Adjustment:

1. Project a white field on the screen.
2. Ensure that the four Y-Adjustment Screws are loose enough to allow movement of the lens assembly.
3. Slowly move the anamorphic lens into place so that there are no shadows on the top or bottom of the screen:

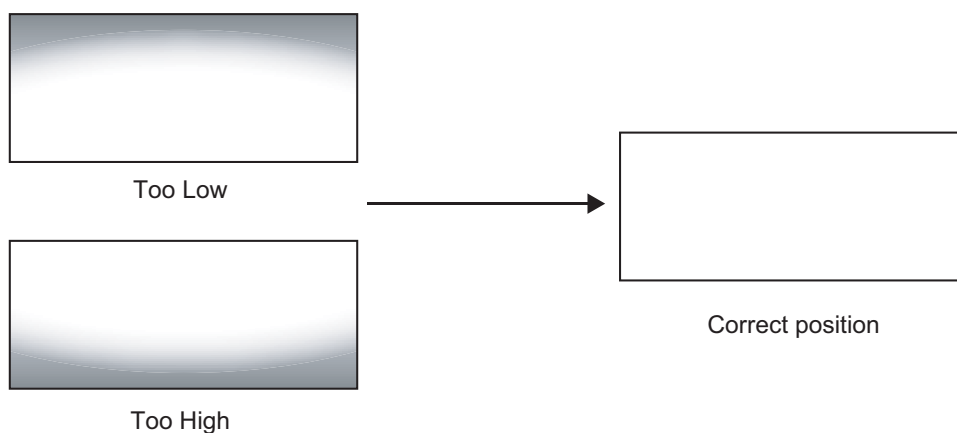

4. When the height is properly set, tighten the Y-Adjustment Screws to secure the lens in place.

Adjusting the Pitch (Angle): Next, angle the lens to even out any top-to-bottom pincushion distortion. To do this, loosen the Pitch Adjustment Screws on either side of the lens to allow it to pivot freely. Then, adjust the anamorphic lens angle so that the projected image is rectangular:

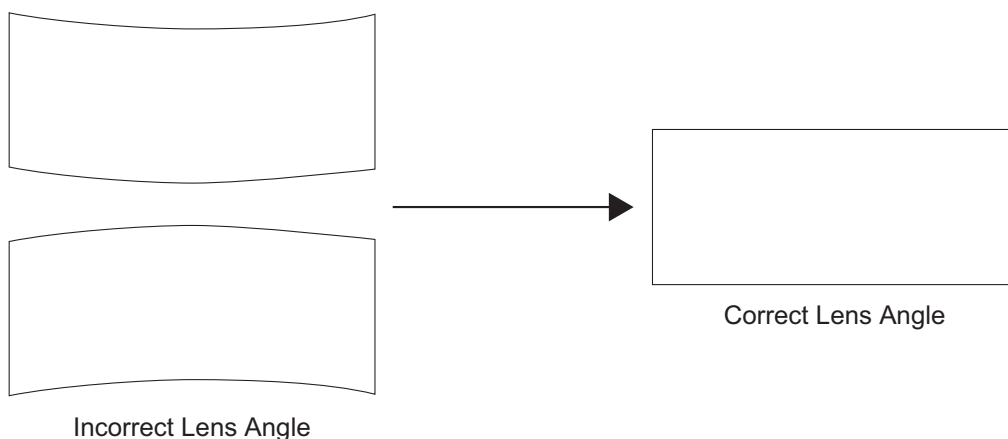

The anamorphic lens will almost always be angled with respect to the projector; this is normal.

Once the proper lens angle has been set, firmly tighten the Pitch Adjustment Screws to secure the lens in place.

◀ **Adjusting the Anamorphic Lens**



To avoid clipping the corners of the image, position the anamorphic lens as close as possible to the primary lens.



There may be some pincushion distortion even after the lens is properly adjusted, especially at shorter throw distances. If this is the case, Runco recommends that you slightly over-scan the image into the screen frame area to mask the distortion.

4. Operation

- Press the **MEM1** button on the remote control to recall settings for the current input from the “Memory 1” memory preset.
- Press **ISF NT (Night)** to recall settings for the current input from the “ISF Night” memory preset.
- Press **ISF DAY** to recall settings for the current input from the “ISF Day” memory preset.



Press **FACT** to recall the factory-default settings for the current input. An on-screen confirmation message appears. Press **FACT** again to confirm.

Use these buttons to select the appropriate aspect ratio for the type of program material being viewed. For more information on aspect ratios, refer to Table 4-1.

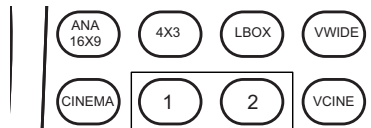

When you turn on the CL-610, it switches to the last selected input and looks for a valid signal.

Use these buttons on the remote control to select an input source directly.

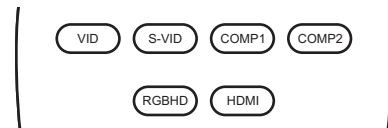

For PIP and PBP purposes, there are two groups of inputs separated by their display modes:

- **Video (SD) group:** Video, S-Video and Component 1 inputs.
- **Graphic (HD) group:** HDMI and Component 2/RGB inputs.

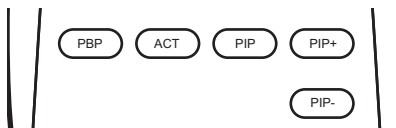

PIP and PBP show one input from the Graphic group within or beside one input from the Video group respectively.

- Press **PBP** to enable the PBP function. Press **PBP** again to switch the screens left to right. Press **PBP** again to turn PBP off.
- Press **ACTIVE** to switch to the active window. (You can only switch inputs in the active window.)
- Press **PIP** to enable the PIP function. Press **PIP** again to switch the main window. Press **PIP** again to turn PIP off.
- To adjust the size of the PIP window, press **PIP+** or **PIP-**.
- Adjust the position of the PIP window with the arrow buttons (▲, ◀, ▼, ▶).

4.1 Selecting Video Memory

4.2 Selecting an Aspect Ratio

4.3 Selecting An Input Source

4.4 Using Picture-In-Picture and Picture-By-Picture (PIP/PBP)

4.5 Turning Off the Power

1. Press the **OFF** button to turn off the projector.
2. The **POWER** LED blinks green and the fans will speed up for a quick cool-down. The projector will not accept any commands during the cool-down period.
3. After approximately three minutes, the fans will stop running and the **POWER** LED lights solid orange.
4. You can turn the projector back on after approximately two minutes.

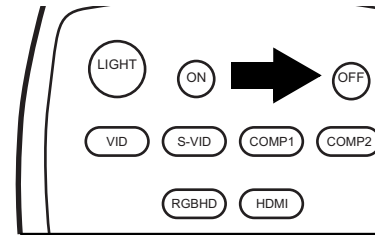

4.6 Using the On-Screen Menus

- Press the **MENU** button on the remote control to display the Main Menu. To select a menu item, use the UP and DOWN buttons on the remote control to highlight it. Press **ENTER** or ► to confirm your selection.
- Use the arrow buttons to select menu items or change settings.
- Press **EXIT** to return to the previous menu.
- Press **MENU** to turn off the OSD menu. (When the Main Menu is displayed, pressing **EXIT** also turns off the menu.)

The CL-610 OSD menus are arranged hierarchically, as shown in Figure 4-1. Depending on the selected input source and signal characteristics, some menu options may not be available.

Video S-Video Component1 Component2 RGB-HD HDMI	Brightness	0 ... 60	Option	Reset Image Settings	Yes / No			
	Contrast	0 ... 32		Sleep Timer	0, 10, 20, 30 ... 180 minutes			
	Color	0 ... 64		Lamp Hours	(read only)			
	Tint	0 ... 30		OSD Timer	0, 3, 6, 9 ... 60 seconds			
	Sharpness	-14 ... 0 ... +20		OSD Position	Horizontal			
	Filter	0, 1, 2 or 3			Vertical			
	Color Temperature	0, 1 (5400 K), 2 (6500K), 3 (8500 K), 4 or 5 (Custom)		PC & HD Adjust (480p and higher-res. signals only)	Auto		Frequency	0, +1, +2, +3 ... +17
	ICC Selection	Standard, NTSC, HDTV or PAL			Phase		0, +1, +2, +3 ... +31	
	Store Image Settings	Memory 1			H. Position		-30, -29 ... 0 ... +29, +30	
Restore Image Settings	Memory 1, ISF Night or ISF Day		V. Position	-28, -27 ... 0 ... +29, +30				
Aspect Ratio	Anamorphic (16:9)		Set Up	PIP/PBP Set Up (not available when used with the SDC-1)	PIP/PBP Enable	On / Off		
	Standard (4:3)			PIP Set Up	PIP Off			
	Letterbox				Graphic in Video			
	Virtual Wide				Video in Graphic			
	Cinema				PBP Off			
	Virtual Cinema			(available only on CL-610 projectors equipped with the CineWide option)	PBP Set Up	Graphic by Video		
		Video by Graphic						
Installation	Language	English, French, Spanish, German or Italian	DNR	0, +1, +2, +3 ... +15				
	Picture Orientation	Floor Front, Floor Rear, Ceiling Front or Ceiling Rear	White Balance	Gamma		Red / Green / Blue		
	Keystone Adjust	-14, -13 ... 0 ... +13, +14		Gain				
	Background Color	Blue or White	Offset					
	RS-232 Baud Rate	9600, 38400 or 115200	Store Color Temp. 4					
	Blue Image	On / Off	Store Color Temp. 5					
			Gamma Selection	2.8, 2.5, 2.2, 1.0, RUNCO Enhance 1, RUNCO Enhance 2 or ISF Day				
			SD Enhance	H Enhance		0, +1, +2, +3 ... +127		
		V Enhance						
		Chroma Enhance						
		H Threshold						
		V Threshold						
		Image Over Scan	Total	0, +1, +2, +3 ... +15				
			Horizontal					
		Image Shift	Vertical					
			Horizontal	-30, -29, ... 0 ... +29, +30				
		Amplitude Adjust	Vertical					
			Horizontal	-60, -59 ... 0 ... +59, +60				
		Horizontal Masking	0, +1, +2, +3 ... +100	(CineWide versions only)				
		Video Black Level	0 IRE or 7.5 IRE					
		Lamp Power	250W or 200W					
		Remote Control	Primary					
		Reset Lamp Timer	Secondary					
			Yes / No					
		Fan Control	Mode	Auto Normal, Auto Hi. Altitude or Manual				
			Fan Speed (Manual Mode)					
		Return to User OSD						
ISF Calibration	Reset Picture Adjust	Yes / No	ISF Calibration	Reset Picture Adjust	Yes / No			
	Picture Adjust	Brightness, Contrast, Color etc.		Picture Adjust	Brightness, Contrast, Color etc.		(see above)	
	White Balance	Gamma, Gain, Offset etc.		White Balance	Gamma, Gain, Offset etc.		(see above)	
	Gamma Selection	2.8, 2.5, 2.2, 1.0, RUNCO Enhance 1, RUNCO Enhance 2 or ISF Day		Gamma Selection	2.8, 2.5, 2.2, 1.0, RUNCO Enhance 1, RUNCO Enhance 2 or ISF Day			
	Blue Image	On / Off		Blue Image	On / Off			
	ICC Adjust	NTSC / HDTV / PAL		ICC Adjust	NTSC / HDTV / PAL		R / G / B / Y / C / M Intensity / Sat. / Hue	
	Store Settings	Memory 1, ISF Night or ISF Day		Store Settings	Memory 1, ISF Night or ISF Day			
	Splash Screen Timer	+5, +6, +7 ... +60 seconds		Splash Screen Timer	+5, +6, +7 ... +60 seconds			
	ISF Enable	On / Off		ISF Enable	On / Off			
	Return to User OSD			Return to User OSD				

Figure 4-1. CL-610 OSD Menu Structure

Main Menu ➤

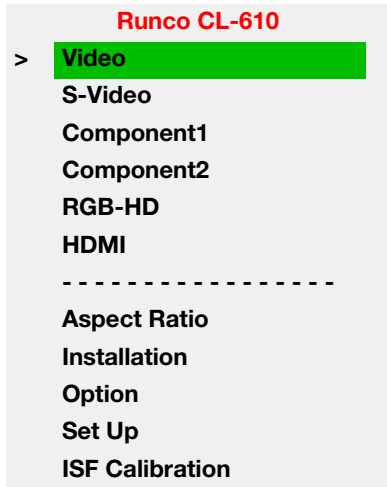

The Main Menu is the starting point for accessing all projector functions.

(The Set Up and ISF Calibration menus are hidden and not accessible until you enter a passcode.)

The active source is indicated by an arrow (>) to its left; in the example at left, Video is the active source. To select a different source, use the ▲ or ▼ button to highlight it and press **ENTER** or ►.

Picture Adjustment ➤

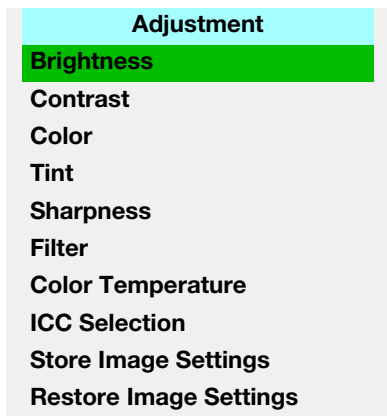

Use the controls in the Adjustment Menu to calibrate your CL-610 for optimum picture quality. To access the Adjustment menu, press **MENU**, highlight the active source and press **ENTER** or ►.

To adjust a setting, use the ▲ or ▼ button to highlight it and press **ENTER**. Use the ◀ or ▶ button to change the setting. When finished, press **EXIT**.

The CL-610 has been designed to incorporate setup and calibration standards established by the Imaging Science Foundation (ISF). The ISF has developed carefully crafted, industry-recognized standards for optimal video performance and has implemented a training program for technicians and installers to use these standards to obtain optimal picture quality from Runco video display devices. Accordingly, Runco recommends that setup and calibration be performed by an ISF certified installation technician.

All signal types require separate processing. Therefore, you need to calibrate each input separately.



Note

*When you change a picture quality setting, save the change to a preset afterwards. Otherwise, the change will be lost when a different input is selected. (Picture quality settings are saved for each input and resolution separately.) For information about saving settings, refer to **Store Image Settings** on page 37.*

Although it may be possible to obtain satisfactory picture quality using the naked eye and regular program material, Runco recommends using the following calibration tools for best results:

- External test pattern source -- Ovation Multimedia, Digital Video Essentials or AVIA test DVD or equivalent.
- A blue filter (provided with many test DVDs), for color level and tint adjustments.

Connect your test pattern source to the input that you are calibrating and proceed as follows. **Perform the adjustments in the order listed here.**

Brightness: On your external test pattern source, select a PLUGE pattern. (PLUGE is an acronym for "Picture Line-Up Generation Equipment.") Figure 4-2 shows a typical PLUGE pattern.

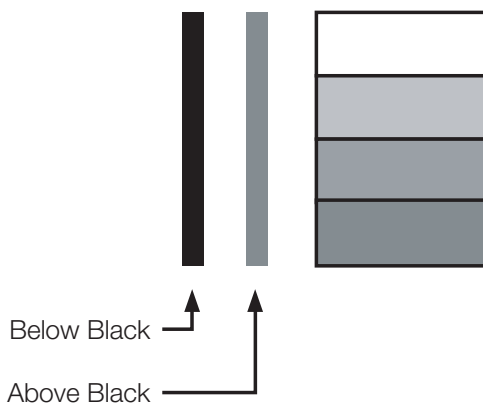

Figure 4-2. Typical PLUGE Pattern for Adjusting Brightness

PLUGE patterns vary but generally consist of some combination of black, white and gray areas against a black background. The example above includes two vertical bars and four shaded boxes.

Select Brightness from the Adjustment menu and press **ENTER**. Adjust the brightness so that:

- The darkest black bars disappear into the background.
- The dark gray areas are barely visible.
- The lighter gray areas are clearly visible.
- The white areas are a comfortable level of true white.
- The image contains only black, gray and white (no color).

Contrast: On your external test pattern source, select a stepped, gray-bar pattern like the one shown in Figure 4-3.

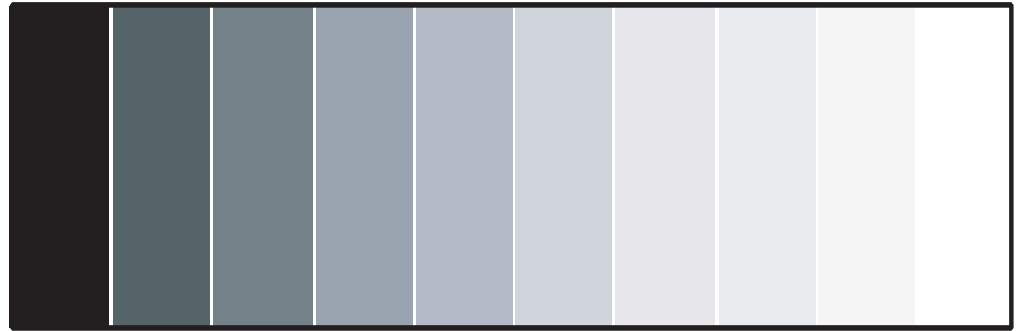

Figure 4-3. Typical Gray Bar Pattern for Adjusting Contrast

Select Contrast from the Adjustment menu and press **ENTER**. Adjust the contrast to a point just below which the white rectangle starts to increase in size.



Note

Brightness and contrast controls are interactive. A change to one may require a subtle change to the other in order to achieve the optimum setting.

Color Saturation: On your external test pattern source, select a color bar pattern like the one shown in Figure 4-4.

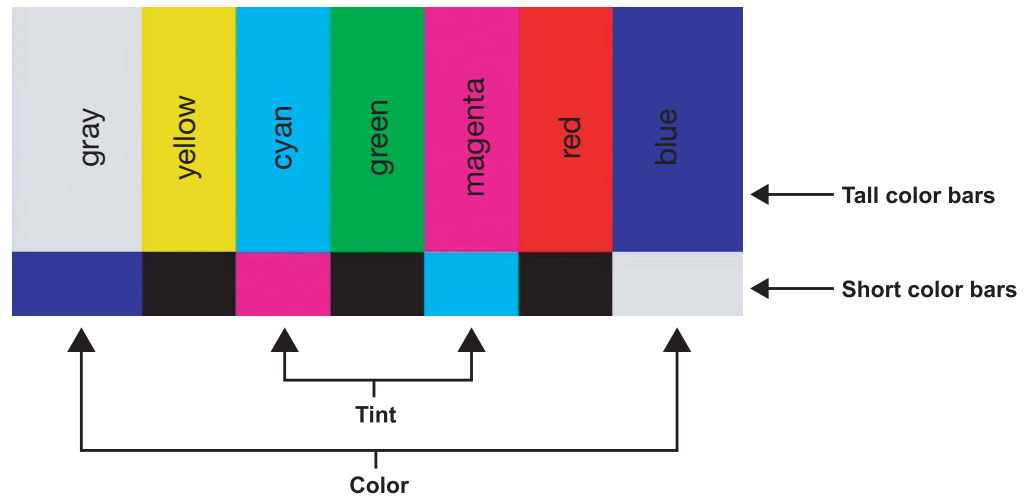
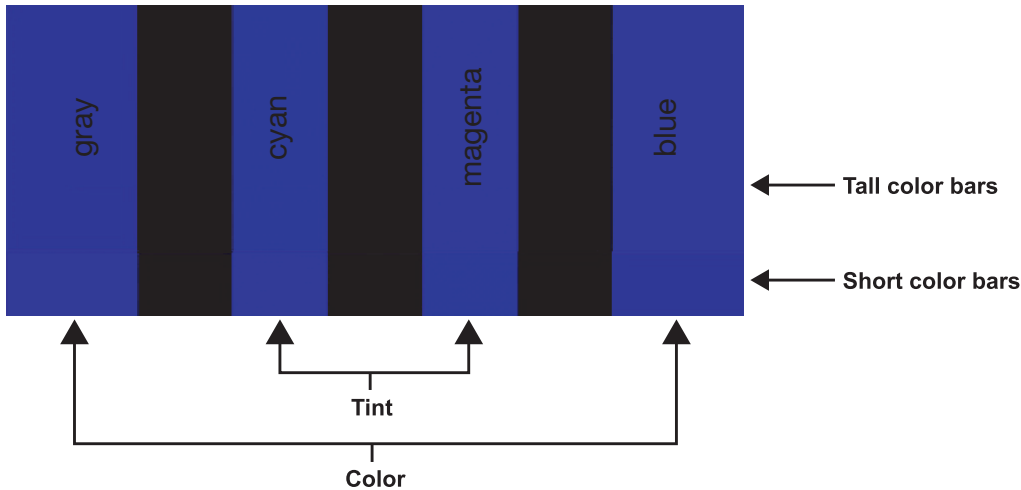

Figure 4-4. Typical Color Bar Pattern for Adjusting Color Saturation and Tint

Select Color from the Adjustment menu and press **ENTER**. While looking at the color bar pattern through a blue filter, adjust the color saturation level until the outermost (gray and blue) color bars appear to be a single shade of blue:



Tint: Tint or “hue” is essentially the ratio of red to green in the color portion of the image. When tint is decreased, the image appears redder; when it is increased the image appears greener. To set the tint, select Tint from the Adjustment menu and press **ENTER**. While looking at the color bar pattern through a blue filter, adjust the tint level until the cyan and magenta color bars (on either side of the green bar) appear to be a single shade of blue.

**Note**

Like the brightness and contrast controls, the color and tint controls are interactive. A change to one may require a subtle change to the other in order to achieve the optimum setting.

Sharpness: “Sharpness” is the amount of high-frequency detail in the image. To adjust sharpness, select Sharpness from the Adjustment menu and press **ENTER**. On your external test pattern source, select a pattern like the one shown in Figure 4-5. Adjust as needed, looking for white edges around the transitions from black to gray and differently-sized lines in the “sweep” patterns at the top and bottom. Lower the sharpness setting to eliminate them.

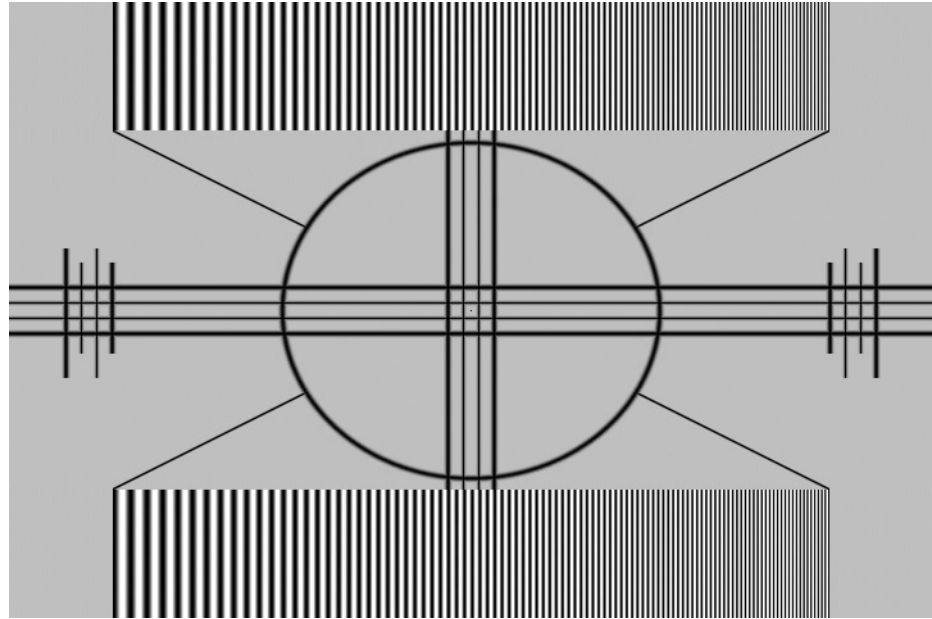

Figure 4-5. Typical Test Pattern for Adjusting Sharpness



Note

The Sharpness setting has no effect if the Sharpness Filter (see below) is set to 0.

Filter: The **Filter** setting controls the behavior of the Sharpness control. The available settings depend on the vertical resolution of the input signal, as follows:

- **With a 480i signal**, you can apply the sharpness control to either the input signal (1), the output signal (2), both (3) or neither (0).
- **With a 480p or higher-resolution signal**, the sharpness control is applied only to the output signal and only when you set the Sharpness Filter to “on” (1).

Color Temperature: The CL-610 has six memory settings for Color Temperature. Four of these settings are factory set to default as follows:

- 0 -- Original lamp color temperature
- 1 -- 5400 kelvins
- 2 -- 6500 kelvins
- 3 -- 8500 kelvins
- 4 -- Custom
- 5 -- Custom

Custom 4 and 5 memory are installer-adjustable and can be used to create custom settings. There are nine adjustable “white balance” parameters available for the Custom 4 and 5 settings (three each for red, green and blue). These are described later in this section; refer to **Set Up** on page 42.

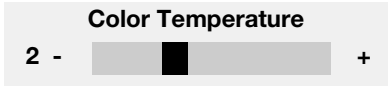

Note

You must enter a passcode in order to enter the Set Up menu.

ICC Selection: Use the ICC Selection menu to select the color space that is appropriate for the source signal, to achieve optimal color balance.



Note

The International Color Consortium (ICC) is a group of imaging product vendors that promotes and develops cross-platform, vendor-neutral color measurement and management standards.

If you select NTSC, HDTV or PAL, you can make further adjustments to individual color space characteristics in the ICC Adjust sub-menu under the ISF Calibration menu, described later in this section. (The Standard color space is factory-set and not adjustable.)

Store Image Settings: Once the desired adjustments have been entered, select Store Image Settings to save these settings into the “Memory 1” memory location.

Restore Image Settings: To recall stored custom image quality settings, select Restore Image Settings and choose “Memory 1,” “ISF Night” or “ISF Day.”

To change the aspect ratio (size and shape) of the projected image, select Aspect Ratio from the Main Menu and press **ENTER**. Select the appropriate aspect ratio for your screen size and the type of program material being viewed; refer to Table 4-1.

◀ **Aspect Ratio**



Note

When you change the aspect ratio, save the change to a preset afterwards. Otherwise, the change will be lost when a different input is selected. (The aspect ratio is saved for each input and resolution separately.)

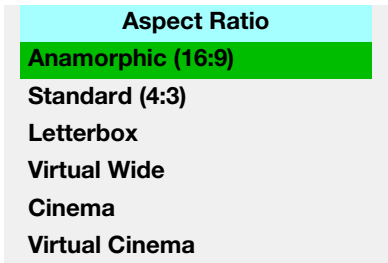

Table 4-1. Aspect Ratio Settings



Aspect Ratio	Remote Control Key	Description	
Anamorphic	ANA	 <p>The diagram consists of two rectangular boxes. The top box is labeled '16:9 Image on 16:9 Screen' and shows a wide rectangle with four white circles at the corners. The bottom box is labeled '4:3 Image on 16:9 Screen' and shows a narrower rectangle with four white circles at the corners.</p>	<p>Select Anamorphic to view 16:9 DVDs and HDTV programs in their native aspect ratio. 4:3 images are stretched horizontally to fit a 16:9 screen.</p>
Standard 4:3	4X3	 <p>The diagram shows a wide rectangle with four white circles at the corners. A smaller, narrower rectangle is centered within it, also containing four white circles. The text 'Active Image Area (4:3)' is centered between the two rectangles.</p>	<p>Standard 4:3 scales the input signal to fit in the center of the 16:9 screen. 4:3 is the aspect ratio used by computer monitors, standard television programming and most VHS video cassettes.</p>
Letterbox	LBOX	 <p>The diagram shows a wide rectangle with four white circles at the corners. A smaller, narrower rectangle is centered within it, also containing four white circles. The text 'Letterbox Image on 16:9 Screen' is centered between the two rectangles.</p>	<p>In Letterbox mode, the image is stretched vertically; the top and bottom portions are “blanked off.” Letterbox is best suited for viewing LaserDisc movies or non-anamorphic DVDs on a 16:9 screen.</p>
VirtualWide	VWIDE	 <p>The diagram shows a wide rectangle with four white circles at the corners. A smaller, narrower rectangle is centered within it, also containing four white circles.</p>	<p>VirtualWide scales a 4:3 image NON-linearly (more on the sides than in the center) to fit a 16:9 screen.</p>

Table 4-1. Aspect Ratio Settings (continued)

Aspect Ratio	Remote Control Key	Description	
Cinema	CINEMA	 <p>2.35:1 Image on 16:9 Screen (without CineWide)</p>  <p>2.35:1 Image on 2.35:1 Screen (with CineWide)</p>	<p>Select Cinema to view 2.35 source material in its native aspect ratio.</p> <p>With a 16:9 screen and a non-CineWide projector (no anamorphic lens), the upper and lower portions of the screen are masked, but the geometry of the active image area is unchanged.</p> <p>With a 2.35:1 screen and a CineWide-equipped projector, the projector enlarges the 2.35:1 image so that the active image area fills the 16:9 chip surface, eliminating the black bars. The secondary anamorphic lens then vertically compresses the image to fit a 2.35:1 screen.</p>
Virtual Cinema	VCINE	 <p>16:9 Image on 2.35:1 Screen</p>  <p>16:9 Image on 2.35:1 Screen with Virtual Cinema</p>	<p>A 16:9 image is scaled NON-linearly (more on the sides than in the center) to fit a 2.35:1 screen.</p> <p>Virtual Cinema is available only on the CL-610/CineWide and CL-610LT/CineWide.</p>

Installation ➤

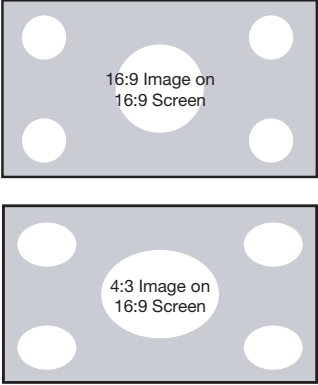
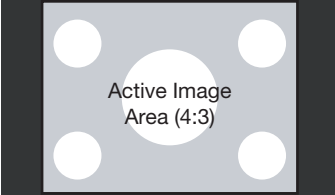
- Installation
- Language
- Picture Orientation
- Keystone Adjust
- Background Color
- RS-232 Baud Rate
- Blue Image

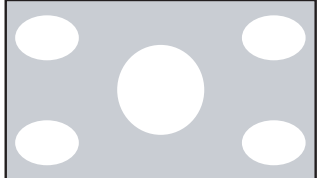
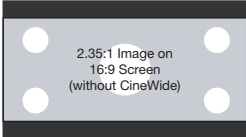
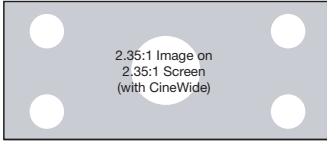
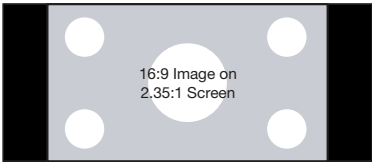
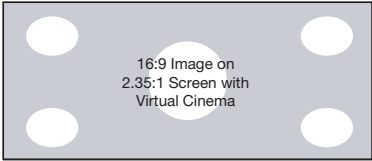
To access the Installation adjustments, press **MENU**, then press the ▲ or ▼ button to highlight Installation and press **ENTER**. The Installation sub-menu, shown at left, appears. Press **EXIT** to return to the previous menu or press **MENU** to close all menus.



Note

*When you change a setting in the Installation menu, the change takes effect immediately; you do not need to press **ENTER** afterwards. (Press **EXIT** to return to the previous menu or **MENU** to exit.)*

Language: Press the ▲ or ▼ button to select from the available languages: English, French, Spanish, German and Italian.

Picture Orientation: Press the ▲ or ▼ button to change the orientation of the projected image. The CL-610 can be installed on a ceiling or in a rear-screen configuration with one or more mirrors. There are four settings: Floor Front, Ceiling Front, Floor Rear and Ceiling Rear.

Keystone Adjust: To correct distortion resulting from the angle of projection, select Keystone Adjust and use the ◀ or ▶ button to make the image rectangular.



Tip

Runco recommends that the keystone feature not be used unless absolutely necessary, as it may cause artifacts in the image.

Background Color: Press the ▲ or ▼ button to select the image Background Color (blue or white). The Background Color appears when no incoming signal is present.

RS-232 Baud Rate: Press the ▲ or ▼ button to select the projector's RS-232 Baud Rate. This function is used to change the transfer rate of the RS-232 connection. (This setting must match the data rate of the device connected to the RS-232 input.)

Blue Image: Press the ▲ or ▼ button to turn the Blue Image Off or On. This feature removes all red and green color information from the image (simulating a blue filter), and is useful for color-calibrating the projector or other video components.

Option ➤

- Option
- Reset Image Settings
- Sleep Timer
- Lamp Hours
- OSD Timer
- OSD Position
- PC & HD Adjust
- PIP/PBP Set Up
- DNR

To access the Option adjustments, press **MENU**, then press the ▲ or ▼ button to highlight Option and press **ENTER**. The Installation sub-menu will then appear (see above). Press **EXIT** to return to the previous menu or press **MENU** to close all menus.

Reset Image Settings: To restore the default image settings for the current input source ONLY, press the ▶ button to highlight "Yes," then press **ENTER**.

Sleep Timer: The Sleep Timer automatically puts the projector into standby mode after the amount of time you specify here. (A warning appears on-screen one minute before this is to occur.)

Use the ◀ or ▶ button to set the timer for anywhere from 10 minutes to 3 hours, in 10-minute increments. To disable the Sleep Timer, set it to 0.

Lamp Hours: To find out how long the projector lamp has been in use, select Lamp Hours and press **ENTER**.

OSD Timer: Use the ◀ or ▶ button to set the OSD Timer. This timer controls how long the menus remain on-screen after selecting them. Select from 0 to 60 seconds, in 3-second increments. When you set the OSD to 0, the menus remain on-screen until you hide them by pressing **MENU**.

To adjust the horizontal and vertical position of the OSD, select OSD Position and press **ENTER**. Then, press the ▲ or ▼ button to select Horizontal or Vertical and use the ◀ or ▶ button to adjust.

PC & HD Adjust: Use the settings in the PC & HD Adjust menu to fine-tune 480p and higher-resolution signals for optimum picture quality.

- **Auto:** Adjusts the phase, frequency and position automatically.
- **Freq.** Adjusts the frequency of the signal.
- **Phase:** Adjust the phase if the image (usually from an RGB source) shows shimmer or “noise.” Pixel phase adjusts the phase of the pixel sampling clock relative to the incoming signal. The effect of this control is similar to that of a tracking control on a VCR.

For best results, use a good test pattern such as a smooth gray consisting of a clear pattern of black and white pixels, or a similar “half on, half off” graphic image. (You may find that you can stabilize the image at more than one point. Use either setting in this case.)

- **H. Pos.:** Adjusts the horizontal position of the image.
- **V. Pos.:** Adjusts the vertical position of the image.



Note

To adjust the image position with a 480i source, use the Image Shift controls in the Set Up menu (see page 43).

PIP/PBP Set Up: Select PIP/PBP Set Up from the Option menu to change the PIP/PBP settings.

- **PIP/PBP Enable:** Press the ▲ or ▼ button to select PIP/PBP Enable, then press **ENTER**. Press the ▲ or ▼ button to select Off or On, then press **ENTER**.
- **PIP Set Up:** Press the ▲ or ▼ button to select PIP Set Up, then press **ENTER**. Press the ▲ or ▼ button to select PIP Off, Graphic in Video or Video in Graphic, then press **ENTER**.
- **PBP Set Up:** Press the ▲ or ▼ button arrows to select PBP Set Up, then press **ENTER**. Press the ▲ or ▼ button to select PBP Off, Graphic by Video or Video by Graphic, then press **ENTER**.

DNR: Use the ◀ or ▶ button to adjust the Digital Noise Reduction (DNR). DNR is useful for clearing up noisy images from interlaced SD sources. Adjust as desired, keeping in mind that reducing noise (which reduces high frequencies) may also soften the image.

Set Up ➤

To access advanced picture quality adjustments, use the up- or down-arrow keys to highlight Set Up and press **ENTER**. Use the number buttons on the remote to enter the Set Up menu passcode when prompted and press **ENTER** again. Then, press **MENU** on the remote control.

Set Up**White Balance**

Gamma Selection

SD Enhance

Image Over Scan

Image Shift

Amplitude Adjust

Horizontal Masking

Video Black Level

Lamp Power

Remote Control

Reset Lamp Timer

Fan Control

Return to User OSD

**Note**

You only need to enter the Set Up menu passcode the first time you select that menu after turning on the projector.

White Balance: To remove any trace of color from the white areas of the projected image, choose White Balance from the Set Up menu and press **ENTER**.

- **Gamma:** “Gamma” is a global setting that determines how gray shades are displayed between minimum input (black) and maximum input (white) for all signals. A good gamma setting helps to optimize blacks and whites while ensuring smooth transitions for the “in-between” values utilized in other grays. Unlike “Brightness” and “Contrast” controls, the overall tone of your images can be lightened or darkened without changing the extremes and all images will be more vibrant while still showing good detail in dark areas.

In all but the most unusual situations, the appropriate “Gamma Selection” (see below) will produce accurate colors and a satisfying contrast level. However, it is sometimes necessary to adjust the red, blue and green gamma curves individually. To do this, select Gamma from the White Balance sub-menu and use the left- and right-arrow buttons to manipulate the on-screen slidebars.

- **Gain:** Use the Gain controls to correct color imbalances in the bright areas of the image. A good way to do this is to use a test pattern consisting mostly of solid white areas, such as an 80 IRE “window” pattern. If the white areas contain traces of red, green or blue, decrease the Gain for that color.
- **Offset:** Use the Offset controls in the White Balance sub-menu to correct color imbalances in the dark areas of the image. A good way to do this is to use a test pattern consisting mostly of dark gray areas, such as a 30 IRE “window” pattern. If the gray areas contain traces of red, green or blue, decrease the Offset for that color.
- **Store Color Temp.4/Store Color Temp.5:** When you are finished adjusting the Gamma, Gain and Offset, select Store Color Temp.4 or Store Color Temp.5 to store your settings. To recall them, set the Color Temperature to +4 or +5 in the Image Adjustment menu (refer to **Picture Adjustment** on page 32).

Gamma Selection: The normal gamma setting of 2.2 is correct for almost all signals and conditions. If excess ambient light washes out the image and it becomes difficult or impossible to see details in dark areas, lower the gamma setting to compensate. This will improve contrast while maintaining good details for blacks. Conversely, if the image is washed out and unnatural, with excessive detail in black areas, increase the setting. Again, good gamma improves contrast while maintaining good details for blacks and whites.

SD Enhance: The SD Enhance menu gives you options for improving the quality of standard-definition, 480i images. (For 480p and higher-definition images, the controls in this menu are disabled.) Keep in mind that these controls add frequencies that are not present in the original signal, and may make images appear “noisy” if misused.

- **H Enhance/V Enhance:** These controls can improve the apparent horizontal and/or vertical resolution of the image.
- **Chroma Enhance:** This control adds chroma (color information) to the input signal and can make colors appear more vibrant and saturated.
- **H Threshold/V Threshold/Chroma Threshold:** Set these to +11 or higher to activate the enhancement controls described above. Generally, the higher the threshold, the more noticeable the enhancements you make will be.

Image Over Scan: Image Over Scan pushes the outside edge of the active picture area of the video signal out beyond the edge of the display area.

Some television programs are produced based on the assumption that older television sets may not display the outer edges of the broadcast picture area. Over scan effectively trims away these inactive, outer edges and enlarges the remaining portion of the image to fill the display area.

Use the on-screen slidebar to select the desired amount of over scan.

For HDTV, DVDs and other video sources, Image Over Scan is generally not necessary or desirable.

Image Shift: The Image Shift menu allows you to precisely center the image on the screen. (These controls are available only with a 480i source signal.)

- **Horizontal:** This control moves the image right or left within the area of available pixels.
- **Vertical:** This option moves the image up or down within the area of available pixels.



Note

1. To adjust the image position with a 480p or higher-resolution source, use the PC & HD Adjust controls in the Option menu, described on page 41.
2. The values shown represent where the approximate center of the image lies in relation to the total number of pixels available horizontally or vertically. This varies widely according to the signal; watch the image while adjusting.

Amplitude Adjust: The Amplitude Adjust menu allows you to fine-tune the currently-selected image aspect ratio by stretching it horizontally or vertically, in small increments. This can be useful if your projector is equipped with an anamorphic lens.

The Horizontal control adjusts the image width while keeping the height constant. Similarly, the Vertical control adjusts the image height while keeping the width constant.

Horizontal Masking (CL-610/CineWide and CL-610LT/CineWide only): To achieve the proper image geometry with the secondary anamorphic lens, select Horizontal Masking from the Set Up menu. Then, use the ◀ or ▶ button to change the native aspect ratio of the display, in small increments.

Video Black Level: This control compensates for incoming elevated black levels present in certain video signals, and ensures that blacks in the display are neither “crushed” (where dark grays appear black) nor excessively elevated (where blacks appear dark gray). By default, the projector automatically determines the best setting according to the type of incoming video signal:

- **0 IRE:** Used for DVD output with “enhanced black,” SECAM, most PAL standards and Japanese NTSC.
- **7.5 IRE:** Used for most NTSC video signals.

For some types of video, you may want to override the setting. Generally, if black appears crushed when brightness = 30, choose “0 IRE.” If black appears excessively elevated, use “7.5 IRE.”

Lamp Power: Select Lamp Power from the Set Up Menu to adjust the lamp output level. You can choose to run the lamp as bright as possible (250W; this is the default setting) or you can choose the lower (200W) setting. Generally, lower lamp output can prolong the life of the lamp, but decreases brightness.

Remote Control: The Remote Control menu shows you the primary and secondary infrared (IR) codes to which the CL-610 will respond. The Primary IR code is permanently set to +20. The secondary IR code is also +20.

You can change the secondary IR code if either:

- Another device in the theater (a DVD player, for example) is responding to commands from the CL-810 remote control in ways that are unpredictable or undesirable.
- You have multiple CL-610 projectors and want to control them independently, as opposed to broadcasting commands from a single remote to all of them. In this scenario, you can use multiple remotes programmed to use different IR codes. Or, you can use a single remote and change the IR code as needed to address a specific projector.

When you change the secondary IR code, the remote sends that code instead of the primary IR code.



Note

The Remote Control menu is read-only and need not be visible in order to change the secondary IR code.

To simultaneously change the secondary IR code and synchronize that remote with a projector, *point the remote at the projector*, then press and hold ◀ and ▶ simultaneously for five seconds. The Remote Control edit window, shown at right, appears. Type a new, two-digit code.

The procedure for changing the secondary IR code on the remote *only* is the same, except that you point the remote away from the projector.

Reset Lamp Timer: When you replace the projector lamp (refer to **Lamp Replacement** on page 49), you should also reset the lamp timer. To do this, select Reset Lamp Timer from the Set Up menu. Press the right-arrow key on the remote to highlight “Yes,” then press **ENTER** to confirm the reset.

**Note**

Reset the Lamp Timer ONLY after you replace the lamp. Otherwise, the reported “Lamp Hours” will be inaccurate.

**WARNING**

Do not exceed the recommended lamp life of 2000 hours. An old lamp becomes increasingly fragile and prone to sudden failure.

Fan Control: Select Fan Control from the Set Up Menu to control the operation of the projector’s cooling fan.

- **Mode:** In most cases, the default Fan Control Mode (Auto Normal) will maintain the correct operating temperature. If the lamp frequently turns off due to overheating, or in certain high-altitude operating environments, you may need to change this setting to Auto Hi. Altitude or Manual.
- **Fan Speed:** If you set the Fan Mode to Manual, select Fan Speed and use the on-screen slidebar to adjust the speed.

After changing either of these settings, press **EXIT** to return to the previous menu.

Return to User OSD: To exit the Set Up menu, use the up- or down-arrow keys to highlight Return to User OSD and press **ENTER**.

To return to the Set Up menu, select it from the Main Menu, press **ENTER** twice, then press **MENU** on the remote control. (You do not need to re-enter the passcode.)

ISF Calibration ►**ISF Calibration****Reset Picture Adjust**

Picture Adjust

White Balance

Gamma Selection

Blue Image

ICC Adjust

Store Settings

Splash Screen Timer

ISF Enable

Return to User OSD

To access the ISF Calibration menu, select ISF Calibration from the Main Menu and press **ENTER**. Use the number buttons on the remote control to enter the ISF Calibration menu passcode when prompted and press **ENTER** again. Then, press **MENU** on the remote control.

**Note**

This menu should be used by ISF-certified technicians only.

Reset Picture Adjust: To restore the ISF default image settings for the current input source ONLY, press the ► button to highlight “Yes” then press **ENTER**.

Picture Adjust: These settings are described in the **Picture Adjustment** section (page 32).

White Balance / Gamma Selection: These settings are described in the previous section, **Set Up**.

Blue Image: This setting is described in the **Installation** section (refer to page 40).

ICC Adjust: Use the ICC Adjust controls to customize the stored NTSC, HDTV and/or PAL color space characteristics. To do this, select the color space to modify. Then, select a component color (Red, Green, Blue, Yellow, Cyan or Magenta).

For each component color, you can adjust the following:

- **Intensity:** This sidebar adjusts the intensity – also known as *luminance* – of a given color.
- **Sat.** This sidebar adjusts the color saturation level – the amount of that color in a video image. Lower settings produce less saturated colors; a setting of “0” removes that color from the image entirely. If the saturation is too high, that color will be overpowering and unrealistic.
- **Hue:** This sidebar adjusts the red/green color hue for true color reproduction of video signals. For best results, adjust tint while displaying an external color bars test pattern (see Figure 4-4). Otherwise, it is recommended that Hue remain at its default setting.

When you have finished customizing the color space, select Store Setting and press **ENTER**.

Store Settings: For each input, the CL-610 lets you store image quality settings as presets that you can recall at a later time. You can create up to three presets per input and resolution.

**Note**

When you change a setting, save the change to a preset afterwards. Otherwise, the change will be lost when a different input is selected. (Most settings are saved for each input and resolution separately.)

To store image quality settings to a preset:

1. Select Picture Adjust from the ISF Calibration menu.
2. Select Color Temperature from the Picture Adjust menu.
3. Use the ◀ or ▶ button to set the color temperature to “4” or “5.” **Make a note of your selection.**
4. Press **EXIT**.
5. Adjust brightness and contrast as described in the **Picture Adjustment** section (page 32). Exit the Picture Adjustment menu when finished.
6. Select White Balance from the ISF Calibration menu. Adjust the grayscale as required (refer to **White Balance** on page 42).
7. From the White Balance menu, select “Store Color Temp. 4” or “Store Color Temp. 5” (depending on your selection in Step 3) and press **ENTER**.
8. From the ISF Calibration menu, select Save ISF Settings and choose “Save ISF Night” to store your settings.
9. Repeat Steps 1 through 8 for the “Save ISF Day” preset.

**Tip**

The first time you perform this procedure, store the current white balance settings in both color temperatures (4 and 5). This will give you a convenient starting point for color temperature 5, should you wish to use it for the other preset.

To recall stored custom image quality settings, select Restore Image Settings from the Picture Adjustment menu (refer to **Picture Adjustment** on page 32) and choose “Memory 1,” “ISF Night” or “ISF Day.” Or, simply use the corresponding buttons on the remote control.

Splash Screen Timer: Use the ◀ or ▶ button to set the Splash Screen Timer. This timer controls how long the startup (ISF and Runco logo) image stays on-screen after you turn on the projector. Select from 5 to 60 seconds, in one-second increments. When finished, press **EXIT**.

ISF Enable: Select ISF Enable from the ISF Calibration menu to control the display of the ISF logo on the CL-610 splash screen upon power-up.

You can personalize the CL-610 splash screen with the projector owner’s name and/or the installer’s name. For instructions, refer to Appendix A.

Return to User OSD: To exit the ISF Calibration menu, use the up- or down-arrow keys to highlight Return to User OSD and press **ENTER**.

To return to the ISF Calibration menu, select it from the Main Menu, press **ENTER** twice, then press **MENU** on the remote control. (You do not need to re-enter the passcode.)

Notes:

Maintenance and Troubleshooting

The lamp should be replaced when it reaches the end of its life (typically 2000 hours), or sooner if a noticeable degradation in brightness occurs. Contact your Runco dealer to obtain a replacement lamp.

5.1 Lamp Replacement

1. Turn off the projector and unplug the power cord.
Allow the projector to cool down for approximately 45 minutes prior to removing the lamp assembly for replacement.

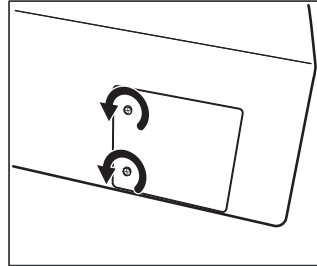

2. Remove the two screws from the lamp cover.

3. Remove the lamp cover.

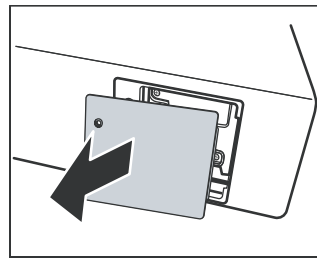

4. Remove the two lamp assembly mounting screws.

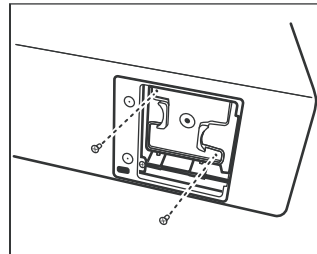

5. Grasp the lamp assembly handle and pull gently, removing the lamp module from the projector housing.

6. Install the new lamp module and replace the two screws you removed in Step 4.

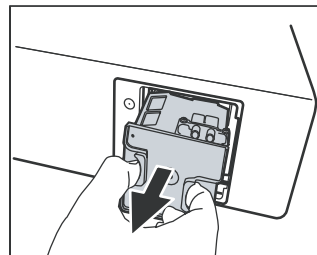

7. Replace the lamp cover at the top first and secure it with the two screws you removed in Step 2.

8. Turn on the power and select Reset Lamp Timer from the Set Up menu to reset the lamp timer (refer to **Reset Lamp Timer** on page 45).

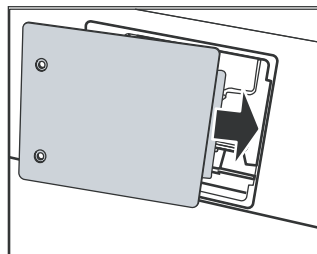

5.2 Troubleshooting Tips

Table 5-1 provides some general guidelines for troubleshooting problems you may encounter with the CL-610. If the suggested solutions fail to resolve the problem or if you encounter an issue not described here, please contact Runco Technical Support.

Table 5-1. Troubleshooting Chart

Symptom	Possible Cause(s)	Solution
The projector does not turn on.	<ul style="list-style-type: none"> The CL-610 is not plugged in or the AC outlet is not active. The main power switch (at the rear of the projector) is off. Lamp cover is not securely attached. 	<ul style="list-style-type: none"> Ensure that the CL-610 is plugged in and that the AC outlet is active. Turn on the power switch. Securely attach the lamp cover.
The projector does not turn back on after it was powered off.	<ul style="list-style-type: none"> The projector will not turn on for two minutes after power-off, to protect the lamp. 	<ul style="list-style-type: none"> Wait until the CL-610 completes its cool-down (POWER LED lights solid orange).
The remote control does not work correctly.	<ul style="list-style-type: none"> The batteries have run out. 	<ul style="list-style-type: none"> Replace the batteries.
The projector is on and OSD menus appear, but there is no video image on-screen.	<ul style="list-style-type: none"> Incorrect source selection. Source component is not turned on. Source component is connected incorrectly or not at all. 	<ul style="list-style-type: none"> Select the correct source. Turn on the source. Check cable connection from source component to projector.
A projected image from a DVD is split or otherwise scrambled.	<ul style="list-style-type: none"> DVD player is connected to the Component input and set to progressive scan mode. 	<ul style="list-style-type: none"> Turn off progressive scan on the DVD player.
Image is blurred.	<ul style="list-style-type: none"> The lens is not correctly focused. 	<ul style="list-style-type: none"> Adjust the focus by turning the focus ring.
Image is too bright and/or lacks definition in the bright areas of the image.	<ul style="list-style-type: none"> Contrast is set too high. 	<ul style="list-style-type: none"> Lower the contrast setting.
Image appears "washed out" and/or dark areas appear too bright.	<ul style="list-style-type: none"> Brightness is set too high. 	<ul style="list-style-type: none"> Lower the brightness setting.
Colors in the image are swapped; for example, reds appear blue or vice versa.	<ul style="list-style-type: none"> The Red/Pr, Green/Y or Blue/Pb outputs from the source are connected to the wrong inputs on the CL-610. 	<ul style="list-style-type: none"> Ensure that the source outputs are connected to the correct CL-610 input.
TEMP and LAMP LEDs are both flashing red.	<ul style="list-style-type: none"> The lamp cover is open. Fans are not working properly. 	<ul style="list-style-type: none"> Close the lamp cover. Please contact your Runco dealer for assistance.

Table 5-1. Troubleshooting Chart (continued)

Symptom	Possible Cause(s)	Solution
LAMP LED lights solid red.	<ul style="list-style-type: none"> The lamp has failed or exceeded its usage life. 	<ul style="list-style-type: none"> Replace the lamp with a new one.
TEMP LED lights solid red.	<ul style="list-style-type: none"> CL-610 internal temperature is too high. 	<ul style="list-style-type: none"> Power off the CL-610 and allow it to cool down. Ensure that the intake and exhaust vents are not blocked. Turn the projector back on. If the problem persists, please contact your Runco dealer for assistance.

Notes:

6. Serial Communications

To interface the CL-610 with a home theater automation/control system or a PC running terminal emulation software:

1. Connect it to your control system or PC as shown in Figure 3-8.
2. Start a terminal session on your PC using a terminal-emulation program, such as HyperTerminal.
3. Configure the RS-232 controller or PC serial port as follows: no parity, eight data bits, one stop bit and no flow control. Set the baud rate to match that of the projector (115200, 38400 or 9600).
4. Press **<Enter>**. You should see a command prompt (>) in the terminal window.
5. Type a command from among those listed in Table 6-1 and press **<Enter>**. For example, to change the aspect ratio to Letterbox, type `x063x` **<Enter>**.

Serial commands to the CL-610 take the following form:

- Commands are in ASCII format.
- Commands are not case-sensitive; `x001x` and `x001x` are equivalent.
- A carriage return MUST follow each command.



Note

The CL-610 will not accept serial commands for 30 seconds after it is turned on or off.

Table 6-1. Serial Commands

Code	Function
x001x	Power On
x002x	Power Off
x003x	Menu
x004x	Enter
x005x	Exit
x006x	Up (arrow key)
x007x	Down (arrow key)
x008x	Left (arrow key)
x009x	Right (arrow key)
x011x	Show active source and aspect ratio information
x021x	Keypad 1

6.1 RS-232 Connection and Port Configuration

6.2 Serial Command Syntax

Table 6-1. Serial Commands (continued)

Code	Function
x022x	Keypad 2
x023x	Keypad 3
x024x	Keypad 4
x025x	Keypad 5
x026x	Keypad 6
x027x	Keypad 7
x028x	Keypad 8
x029x	Keypad 9
x030x	Keypad 0
x031x	Store image settings to Memory 1
x032x	Store image settings to ISF Night
x033x	Store image settings to ISF Day
x046x	Restore image settings from Memory 1
x047x	Restore image settings from ISF Night
x048x	Restore image settings from ISF Day
x049x	Load default of current source
x051x	Single source, full-screen
x052x	PIP - graphics on video
x053x	PIP - video on graphics
x054x	PBP - graphics by video
x055x	PBP - video by graphics
x056x	PIP - increase sub-window size
x057x	PIP - decrease sub-window size
x058x	Set PIP/PBP active window
x061x	Anamorphic (16:9) aspect ratio
x062x	Standard (4:3) aspect ratio
x063x	Letterbox aspect ratio
x064x	VirtualWide aspect ratio
x065x	Cinema aspect ratio
x066x	Virtual Cinema aspect ratio
x071x	RS-232 baud rate = 9600
x072x	RS-232 baud rate = 38400

Table 6-1. Serial Commands (continued)

Code	Function
x073x	RS-232 baud rate = 115200
x081x	Image orientation = floor front
x082x	Image orientation = ceiling front
x083x	Image orientation = floor rear
x084x	Image orientation = ceiling rear
x091x	Lamp Power = 200W
x092x	Lamp Power = 250W
x121x	OSD Language = English
x122x	OSD Language = French
x123x	OSD Language = Spanish
x124x	OSD Language = German
x125x	OSD Language = Italian
x131x	Switch to Composite input
x132x	Switch to S-Video input
x133x	Switch to RGB-HD input
x134x	Switch to DVI input (HDMI)
x135x	Switch to Component 1 input
x136x	Switch to Component 2 input
x156x	Background Color = Grey
x157x	Background Color = Blue
x158x	Background Color = White
x161x	Un-freeze Image
x162x	Freeze Image
x181x	Toggle Blue Image on/off

Notes:

7. Specifications

Table 7-1 lists the CL-610 specifications.

Table 7-1. CL-610 Specifications

Projector Type:	Digital Light Processing (DLP), Single-Chip DMD
Native Resolution:	1280 x 720 (16:9)
Aspect Ratios:	4:3, Letterbox, 16:9 Anamorphic, VirtualWide, Cinema, Virtual Cinema
Video Standards:	NTSC, PAL, SECAM
DTV Compatibility:	480p, 576p, 720p, 1080i
Scan Frequency:	Horizontal: 15 - 80 kHz Vertical: 50 - 100 Hz
Picture Size (16:9 Screen):	Recommended Width: 72 in. (1.83 m) to 96 in. (2.44 m) Capable of screen widths between 48 in. (1.22 m) and 200 in. (5.08 m)
Throw Distance (Factor x Screen Width):	Refer to Table 3-3
Horizontal and Vertical Lens Shift:	None; electronic image shift via OSD controls
Video Inputs:	(1) Composite Video, (1) S-Video, (1) RGB/Component Video (5x BNC), (1) RCA Component Video, (1) HDMI
Control Options:	<ul style="list-style-type: none">- Discrete IR remote- Built-in keypad- Serial commands via RS-232
RS-232 Communication Parameters:	9600, 38400 or 115200 bps, no parity, 8 data bits, 1 stop bit, no flow control
12V Output:	Max. 0.25 Amps, active when projector is turned on; Tip = +12V; Sleeve = Ground

7.1 CL-610 Specifications

Table 7-1. CL-610 Specifications (continued)**Brightness and Contrast:****Cinema Standards Measurement System (CSMS) Specifications**

- Brightness: 14.5 to 21.6 foot-Lamberts (fL)
- Contrast Ratio: 200:1 to 220:1

These measurements are taken from the projector in a controlled, home theater environment. All measurements are made to ANSI/NAPM IT7.228-1997 specifications using the Photo Research PR-650 SpectraColorimeter and Minolta LS-100 Luminance Meter, Video Essentials test DVD and a 1.3 gain, 72-inch wide screen. The projector is calibrated to a color temperature of 6,500K and has a minimum of 150 hours of usage.

The foot-Lambert (fL) is the unit of measurement used in commercial movie theaters to express image brightness at the screen surface. The Society of Motion Picture and Television Engineers (SMPTE) specifies 16 fL as the target image brightness for film-based projectors using an open gate (without film in the projector). More importantly, today SMPTE specifies 12 fL as the target image brightness in Digital Cinema theaters. The foot-Lambert measurement is dependent on screen size, screen gain and projector light output.

Home Theater Calibration Specifications

- Light Output: 442 to 587 ANSI Lumens
- Contrast Ratio: 200:1 to 220:1

These specifications are obtained by calibrating the projector as described above for CSMS measurements.

Industry-Standard Specifications

- Light Output: 1250 ANSI Lumens
- Contrast Ratio: 1500:1 to 3100:1

These are typical projector brightness and contrast specifications found in most companies' sales literature. Runco includes these measurements in its literature to allow for direct comparison with other manufacturers' projectors. These measurements are typically taken at 9,000K to 13,000K to get expected performance data when the projector is used in professional, commercial and industrial displays.

Lamp:	250 Watts
Estimated Lamp Life:	2000 hours
Power Requirements:	100 to 240 VAC (auto-sensing), 50/60 Hz, 310 Watts
Operating Environment:	41°F to 95°F (5°C to 35°C), 20% to 80% humidity (non-condensing)
Dimensions:	See Figure 7-1
Weight (without lens):	34 lbs. (15.42 kg)
Regulatory Approvals:	Complies with FCC, CE C-Tick
Limited Warranty:	Projector: Two (2) years parts and labor from the date of delivery to the end user. Lamp: 1000 hours or six (6) months, whichever comes first.
Specifications are subject to change without notice.	

Figure 7-1 shows the CL-610 dimensions.

7.2 CL-610 Dimensions

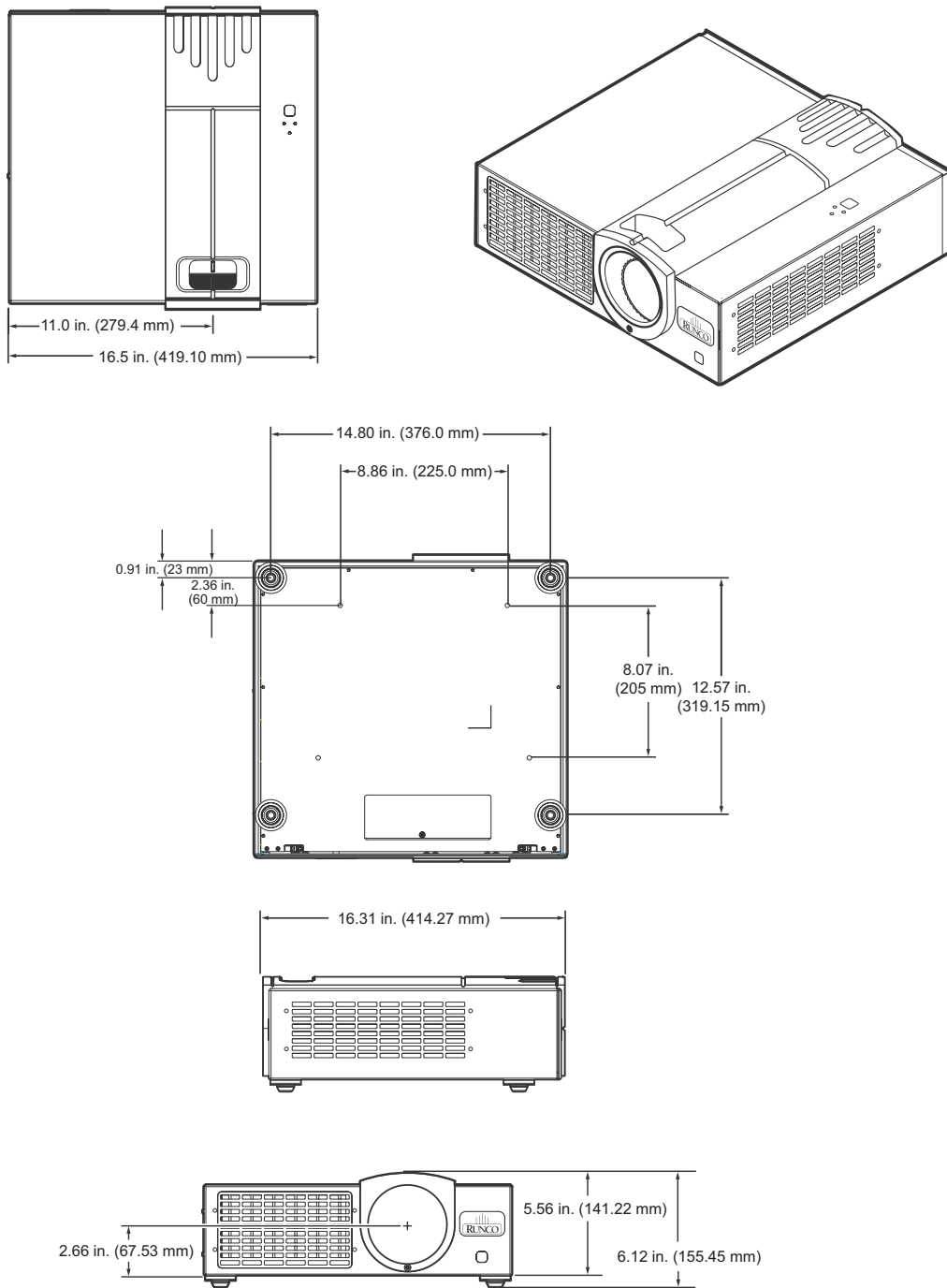

Figure 7-1. CL-610 Dimensions

Notes:

Appendix A. Personalizing the ISF Splash Screen on the CL-610

Screen on the CL-610

This Appendix describes how to personalize the ISF splash screen on the Runco CL-610 Series DLP Projectors.



Note

Only ISF-trained and -certified technicians should attempt this procedure!

1. Connect a PC to the CL-610 RS-232 port and establish a serial connection; refer to **RS-232 Connection and Port Configuration** on page 53 if you need instructions.
2. Press **MENU** on the **projector** remote control. Use the up- or down-arrow keys to highlight **ISF Calibration** and press **ENTER**. Use the number buttons on the remote control to enter the ISF Calibration menu passcode, then press **ENTER** again.
3. Press **MENU** on the projector remote control. Then, select **Splash Screen Timer** from the ISF Calibration menu.
4. Use the left- or right-arrow buttons to set the Splash Screen Timer. This timer controls how long the startup (Runco/ISF logo) image stays on-screen after you turn on the projector. The range is from 5 to 60 seconds in 1-second increments. For this procedure, set it to 30 seconds and press **EXIT**.
5. In the HyperTerminal window, at the command prompt (>), type U1 followed by the customer name, four or five spaces and the ISF calibrator name:

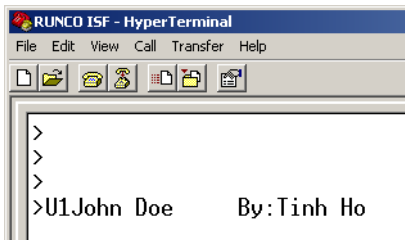

6. Press **<Enter>**.
7. Press **MENU** on the projector remote control. Then, select **ISF Calibration** from the Main menu.
8. Select **ISF Enable** from the ISF Calibration menu and set it to **On**.

9. Power-cycle the projector to see the change:



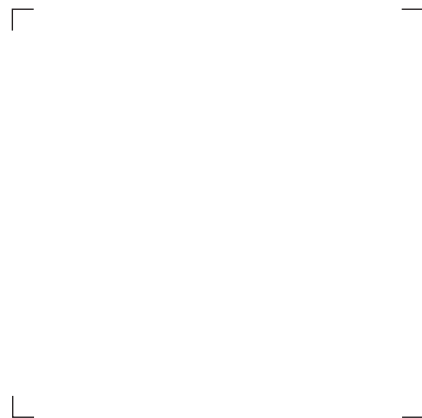

SERIAL NUMBER
RUMA-011115
rev 10-24-06 v2.0

Free Manuals Download Website

<http://myh66.com>

<http://usermanuals.us>

<http://www.somanuals.com>

<http://www.4manuals.cc>

<http://www.manual-lib.com>

<http://www.404manual.com>

<http://www.luxmanual.com>

<http://aubethermostatmanual.com>

Golf course search by state

<http://golfingnear.com>

Email search by domain

<http://emailbydomain.com>

Auto manuals search

<http://auto.somanuals.com>

TV manuals search

<http://tv.somanuals.com>