



Russell Hobbs

23 Litre Digital Microwave with Grill



Model Number: RHM2308

Please read these instructions carefully
and keep them for future reference

For Customer Services & Spare Parts please call
01204 664 084

Opening times: Monday – Friday
9am – 5pm

Contents

	Page
About this microwave oven	3
Safety instructions.....	4
Microwave oven Installation.....	5
Feature diagram.....	6
Connection to the mains supply.....	6
Control panel.....	7
Operating instructions.....	8
Setting the clock.....	8
Microwave cooking.....	8
Grill Cooking.....	9
Combination Cooking I.....	10
Combination Cooking II.....	10
Express cooking.....	10
Auto defrost.....	10
Auto Cooking.....	10
Child safety lock.....	11
Cleaning and care.....	11
Problem solving.....	12
Important utensil information.....	12
Non-rewireable mains plug.....	14
Specification.....	14

For Customer Services & Spare Parts please call **01204 664 084** Opening times: Monday – Friday 9am – 5pm

About this microwave oven

Microwaves are high-frequency electromagnetic waves similar to radio waves. While radio waves may vary in length from one metre to many kilometres, microwaves are very short (less than 12.5 centimetres). Microwaves do not make any heat themselves but only cause water molecules in food to vibrate. This vibration produces the heat that cooks the food. This is why your food will come out of the microwave piping hot, when your utensils inside the oven stay much cooler. The microwaves do not stay in the air or in the food when you open the microwave oven door.

The microwave oven will work using an ordinary household electrical socket. Inside the microwave oven is the magnetron, which turns the electrical energy into microwaves. Microwaves cannot go through metal, so the inside of the oven is lined with metal. The door is lined with a fine metal mesh which stops microwaves getting through. This means that when the microwave oven door is shut, there is no possibility that microwaves can be released. This is why the microwave oven has been made so that it will not work when the door is open.

Before you use your microwave oven

- 1 Remove all the packaging. **Do not remove** the small piece of card from the right hand side of the cavity wall. This is called a wave-guide cover and allows the microwaves to pass through to cook the food.
- 2 Check the oven after unpacking for any visual damage such as:
 - A misaligned door
 - Damage to the door
 - Dents or holes in the door window and screen
 - Dents in the inside

If you can see any damage do not use the oven

Safety instructions

Warning: this oven must be positioned so that the plug is accessible and the plug socket is within easy reach of the power cord.

Warning: only allow children to use the oven without supervision when adequate instructions have been given so that the child is able to use the oven in a safe way and understands the hazards of improper use.

- Children should be supervised to ensure they do not play with the appliance, and the appliance and cable should be kept completely out of reach of young children.
- This appliance is not designed for use by children, or persons with reduced physical, sensory or mental capabilities, and should not be used by such persons unless they can do so safely. Where necessary, such persons (or anyone with lack of experience or knowledge) should first be given supervision or instruction concerning use of the appliance by a person responsible for their safety.

Warning: it is hazardous for anyone other than a competent person to carry out any service or repair operation which involves the removal of a cover which gives protection against exposure to microwave energy.

Warning: if the door or door seals are damaged, the oven must not be operated until it has been repaired by a competent person. The door seals are located around the window on the inside of the door. These seals are not airtight, although no microwaves can be released; it is normal for small amounts of air or steam to escape when the oven is in use.

Warning: liquids and other foods must not be heated in sealed containers, as they are liable to explode.

- Do not operate the microwave if damaged or after it malfunctions. In the event the supply cord is damaged, it must only be replaced by a qualified service engineer, with a suitably approved part.
- Keep the microwave, cable and plug dry, never immerse in water.
- When heating food in plastic or paper containers, keep an eye on the oven due to the possibility of ignition
- Only use the oven for preparing food. For example do not use for drying clothes, paper or any other non-food items, or for sterilising purposes.
- To avoid damaging the oven, do not use the oven when the cavity is empty. The oven may be empty (used as a timer) with the power set to zero
- Do not use the oven when it is empty. This could damage the oven.
- Do not store anything in the oven, such as papers, cookbooks and so on.
- Do not cook any food surrounded by a membrane, such as egg yolks, potatoes, chicken livers, ready meals and so on without piercing them several times with a fork.
- Eggs in their shell and whole hard-boiled eggs should not be heated in microwave ovens since they may explode, even after microwave heating has ended.
- Never cover the air vents or put any objects into the openings in the outer case.
- Never remove parts from the oven such as the feet, screws and so on.
- Only use utensils recommended in these instructions
- Do not try to deep-fry foods in this oven.
- Heat from the contents of a container may be transmitted to the container itself, so please be careful when removing it from the oven. Please remember that the food or liquid inside will be releasing some steam or will be spitting. Never cover any container fully, always leave a gap for steam to escape.
- Cooking utensils may become hot because of heat transferred from the heated food. This is especially true if plastic wrap has been covering the top and handles of the utensil. You may

For Customer Services & Spare Parts please call **01204 664 084** Opening times: Monday – Friday 9am – 5pm

- need oven gloves to handle the utensil.
- In order to avoid burns, the contents of feeding bottles and baby food jars shall be stirred or shaken and the temperature checked before consumption.
- Always test the temperature of cooked food, never eat or drink food or liquid straight from the oven, allow it to stand for a few minutes and stir to distribute the heat evenly.
- Microwave heating of beverages can result delayed eruptive boiling, therefore care must be taken when handling the container.
- Food containing a mixture of fat and water (for example, stock) should stand for 30 to 60 seconds in the oven after it has been turned off. This is to allow the mixture to settle and to prevent it from bubbling when a spoon is placed in it, or a stock cube is added.
- When heating or cooking food or liquid, remember that there are certain foods (such as Christmas puddings, jam and mincemeat), which heat up very quickly.
- When heating or cooking foods that contain a lot of fat or sugar, do not use plastic containers.
- Always have the glass tray and turntable support in place when using the oven.
- Do not cook food directly on the glass tray. Put food on a suitable plate or in a bowl before putting it in the oven.

To reduce the risk of fire in the oven cavity:

- Do not overcook food
- Do not leave the microwave oven unattended while you are using it
- Remove wire twist-ties from bags before putting the bag in the oven
- If materials inside the oven catch fire, keep the oven door closed, turn the oven off at the wall switch, or shut the power off at the fuse or circuit-breaker panel

FOOD SAFETY

- Do not cook raw meat or raw shellfish in a microwave, due to the possibility for uneven heating.
- Do not use the microwave oven for home canning or bottling. Improperly canned or bottle foods may spoil and be dangerous to eat.
- Follow cooking instructions on food packaging and always check the temperature of food before serving.

Microwave oven installation

Warning: do not install the oven over a cooker or other heat producing appliance. This will damage the oven. The oven must be placed away from high temperatures and steam.

- This microwave oven weighs approximately 12kg so you must put it on a horizontal surface that is strong enough to support this weight.
- This microwave is designed to be free standing and is not intended to be used 'built in' or in a cabinet.
- Do not put anything on the top of the microwave oven.
- Only use the accessories supplied by the manufacturer.

1. Select a level surface that provides enough space for the outlet vents.
2. A minimum clearance of 3 inches (7.5cm) is required between the oven and any adjacent walls. One side must be open. Leave a minimum clearance of 12 inches (30cm) above the oven.
3. Place the oven as far away from radios and TV's as possible. Using the oven may cause interference with the reception.
4. Plug the oven into a suitable 13amp mains socket, make sure the voltage is the same as on the rating label (do not use extension cables or mains socket adaptors).

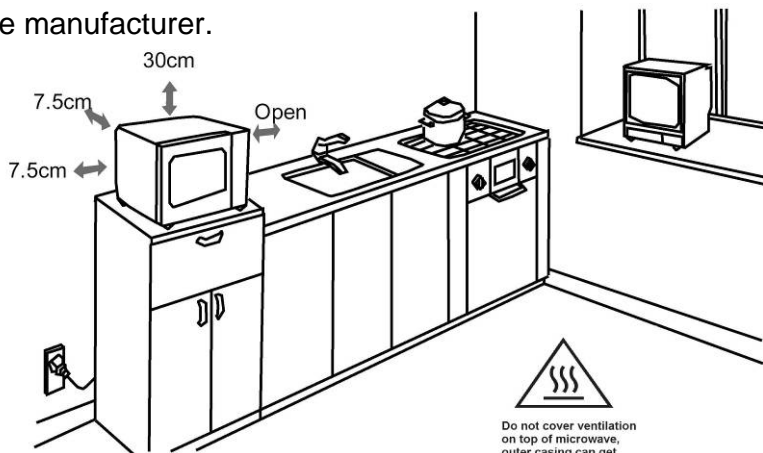

For Customer Services & Spare Parts please call **01204 664 084** Opening times: Monday – Friday 9am – 5pm

Feature diagram

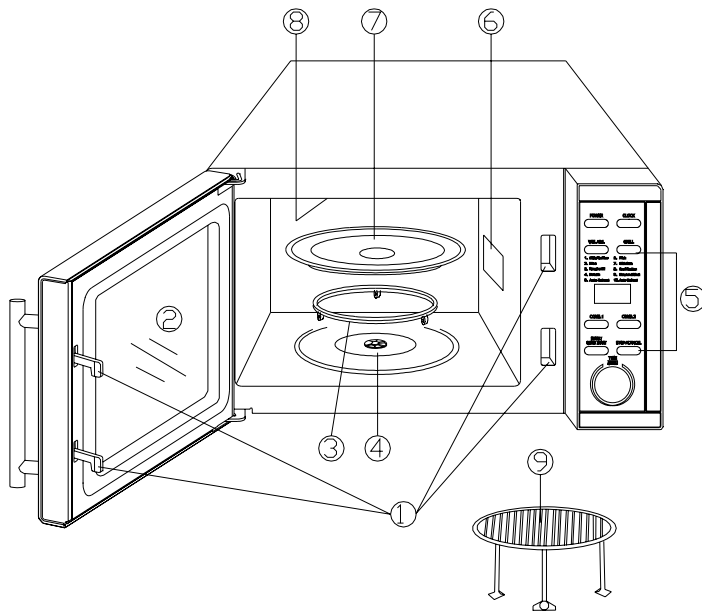

- 1 Door safety lock system
- 2 Oven window
- 3 Roller Ring
- 4 Shaft
- 5 Control Panel
- 6 Wave guide cover (do not remove)
- 7 Glass tray
- 8 Grill Heater
- 9 Mental Rack

Connection to the mains supply

WARNING - THIS APPLIANCE MUST BE EARTHED

This appliance is designed to operate from a mains supply of AC230-240V ~ 50HZ. Check that the voltage marked on the product corresponds with your supply voltage. This product is fitted with a 13A plug complying with BS1363.

If this plug is unsuitable or needs to be replaced, please note the following:

Important: The wires in the mains lead are coloured in accordance with the following code:

GREEN/YELLOW-EARTH

BLUE-NEUTRAL

BROWN-LIVE



DANGER
Electric
Shock Risk

Control panel

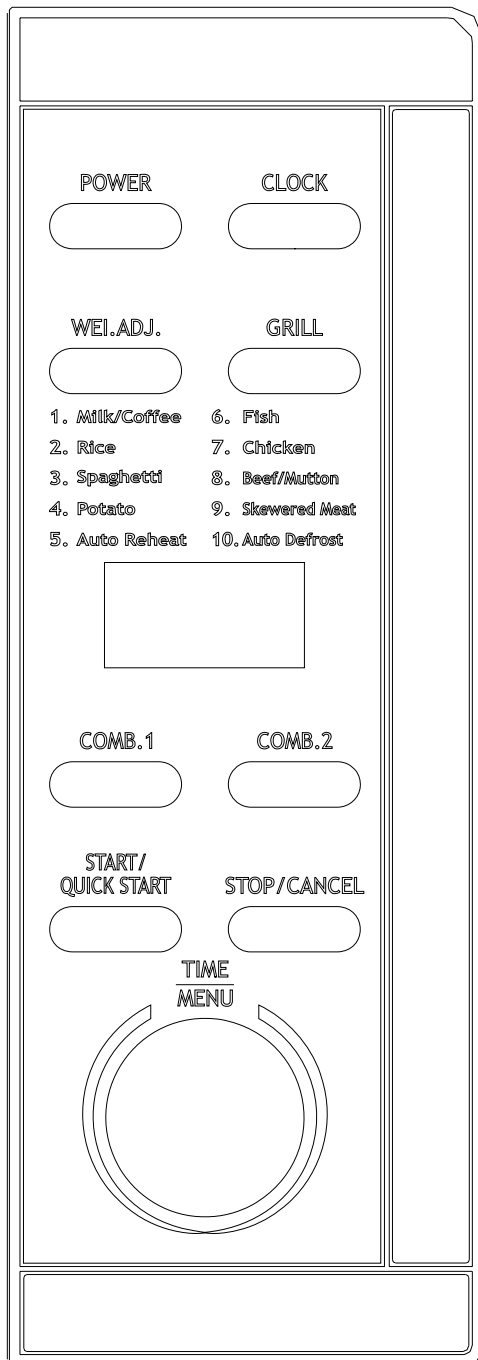

- **MENU ACTION SCREEN**

Cooking time, power, action indicator, and clock time are displayed.

- **POWER**

Press to select microwave power level.

- **CLOCK**

Touch to set the digital clock.

- **GRILL**

Press to set a grill-cooking program.

- **WEI.ADJ.**

Press to specify the food weight or the number of serving.

- **AUTO COOK MENU**

Milk/Coffee, Rice, Spaghetti, Potato, Auto reheat, Fish, Chicken, Beef/Mutton, Skewered Meat, Auto Defrost

- **COMB.1/COMB.2**

Cooking with combined microwave and grill power.

- **START/QUICK START**

Touch the button a number of times to set cooking time and cook immediately at full power level.

Touch to start a cooking program.

- **STOP/CANCEL**

Touch to stop cooking program or clear all previous settings before cooking starts.

✧ It is also used to set child lock.

- **TIME/MENU**

Turn the dial to set the oven clock time and input cooking time.



Turn the dial to select an auto-cooking menu including auto defrost.

2. After cooking, the system will beep four times and END is displayed.

GRILL COOKING

Grill cooking is particularly useful for thin slices of meat, steaks, chops, kebabs, sausages and pieces of chicken. It is also suitable for hot sandwiches and au gratin dishes. The longest cooking time is 60 minutes.

Suppose you want to program grill cooking for 12 minutes.

1. Press the STOP/CANCEL button once to reset the system.
2. Press GRILL button, the display shows “ : 1 0”, “” and  flashing.
3. Turn the TIME/MENU dial to enter cooking time until the correct cooking time (12:00) is displayed.
4. Press START/QUICK START button, the displays shows “”.

COMBINATION COOKING I

30% of time for microwave cooking, 70% for grill cooking. Use for fish, potatoes or au gratin. Suppose you want to set combination 1 cooking for 25 minutes.

1. Press COMB.1 button, the display shows “ : 1 0”, “COMB1” and  flashing.
2. Turn TIME/MENU dial to enter 25:00.
3. Press START/QUICK START button.

COMBINATION COOKING II



55% of time for microwave cooking, 45% for grill cooking. Use for pudding, omelets, baked potatoes and poultry.

Suppose you want to set combination 2 cooking for 12 minutes.

1. Press COMB.2 button, the display shows “ : 1 0”, “COMB2” and  flashing.
2. Turn TIME/MENU dial to enter 12:00.
3. Press START/QUICK START button.

EXPRESSING COOKING

This feature allows you to start the oven quickly at high power.

Press the START/QUICK START button to set the cooking time, the oven starts work at full power level after 2 seconds, the displays shows 、. The longest cooking time is 12 minutes.

Suppose you want to set 2 minutes for quick start.



1. If needed, press the STOP/CANCEL button once to reset the system.
2. Press START/QUICK START repeatedly until display 2

Note: After cooking, the system will beep four times and END is displayed.

AUTO DEFROST

The oven allows the defrosting of meat, poultry, and seafood. The time and the defrosting power are adjusted automatically once the weight is programmed. The range weight of frozen foods varies from 100g to 1800g.

FOR EXAMPLE: Suppose you want to defrost 600g of shrimp.

1. Place the shrimp to be defrosted into the oven.
2. Turn TIME/MENU dial until the display “1 00” , and “AUTO”、、 flashing.
3. Turn TIME/MENU dial again to choose a weight 600g.
4. Press START/QUICK START button.

Note: In the middle of cooking time the system will sound to remind you to turn over the food and pause until you depress the button START/QUICK START to enter into the next defrosting stage, and the system resume

For Customer Services & Spare Parts please call **01204 664 084** Opening times: Monday – Friday 9am – 5pm

AUTO COOK

For food or the following cooking mode, it is not necessary to program the duration and the cooking power. It is sufficient to indicate the type of food that you wish to cook as well as the weight of this food.

You may need to turn food over at the middle of cooking time to obtain uniform cooking.
For example: to cook 400g of fish.

1. Turn TIME/MENU dial until display code 6.
2. Press WEI.ADJ. button repeatedly until display 400g.
3. Press START/QUICK START button.

Note: After cooking, the system will beep four times and END is displayed.

Auto Cook Code/Menu

Code	Food/cooking mode	
1	Milk/Coffee (each 200ml)	<ol style="list-style-type: none">1. Press WEI.ADJ. button to indicate weight of food2. The result of auto cooking depends on factors such as the shape and size of food, your personal preference as to the doneness of certain foods and even how well you happen to place food in the oven. If you find the result at any rate not quite satisfactory, please adjust the cooking time a little bit accordingly.3. For spaghetti add boiled water before cooking.4. For item 7, 8 and 9, oven will stop during cooking to let you turn food over and then close the door, press the START/QUICK START button to resume cooking.
2	Rice (g)	
3	Spaghetti (g)*	
4	Potatoes (each 230g)	
5	Auto Reheat (g)	
6	Fish (g)	
7	Chicken (g)	
8	Beef/Mutton (g)	
9	Skewered Meat (g)	

CHILD SAFETY LOCK

Use to prevent unsupervised operation of the oven by little children. The CHILD LOCK indicator will show on display screen, and the oven can not be operated while the CHILD LOCK is set.

To set the Child Lock: In standby mode, press and hold the PAUSE/CANCEL button for 3 seconds, a beep sounds and "🔒" lights, now all buttons (except PAUSE/CANCEL) are disabled.

To cancel the Child Lock: Press and hold the PAUSE/CANCEL button for 3 seconds until lock indicator on display goes off.

Cleaning and Care

Failure to maintain the oven in a clean condition, could lead to deterioration of the surface that could adversely affect the life of the appliance and possibly result in a hazardous condition. The oven should be cleaned regularly and any food deposits removed.

- Before you clean the microwave oven, turn it off and unplug it.
- Keep the inside of the oven clean. When food or liquids stick to the oven walls, wipe with a damp cloth. We recommend that you do not use harsh detergent or abrasives.
- On the right hand side wall of the cavity is the wave guide cover. Microwaves are passed through this cover to enable your food to cook. It is important that the wave guide cover is kept clean at all times. To do this wipe with mild detergents and water, then dry. Do not remove the waveguide cover.
- You should clean the outside of the oven with a damp cloth and polish dry with a soft dry cloth. Do not allow water to seep into the ventilation openings.
- Wipe the door and window on both sides, the door seals and adjacent parts frequently with a damp cloth to remove any spills or spatters. Do not use an abrasive cleaner.
- Do not allow the control panel to become wet. Clean with a soft, damp cloth. Do not use detergents, abrasives or spray-on cleaners on the control panel.
- If steam builds up inside or around the outside of the oven door, wipe with a soft cloth. This may happen when the microwave oven is used in humid conditions.
- If the inside of the oven smells, put a cup of water with the juice and the skin of one lemon in a deep microwave bowl. Microwave it for three minutes, wipe the cavity walls thoroughly and then dry with a soft cloth.
- Regularly clean the turntable support and oven floor. Simply wipe the bottom surface of the oven with mild detergents and water, and then dry. You can wash the turntable support in soapy water. Check that it is correctly fitted after cleaning.
- Regularly remove the glass tray to clean it, and wash in warm soapy water.
- Do not remove the waveguide cover on the inside wall of the cavity.

Problem solving

The microwave oven may cause interference to your radio, TV or similar equipment. If it does, you can get rid of the interference by moving the radio, TV or equipment as far away from your microwave oven as possible.

If the oven doesn't work, if the display does not appear or if the display has disappeared

- Make sure the oven is plugged in securely. If it is not, remove the plug from the socket, wait 10 seconds and plug it in again securely.
- Check the premises for a blown circuit fuse or a tripped main circuit breaker. If these seem to be working properly, test the socket with another appliance.

If the microwave power will not work

- Make sure the door is securely closed. Otherwise, the microwave energy will not flow into the oven.

Important utensil information

- Use only cookware that is approved to be used in a microwave oven.
- Do not use metal pans or dishes with metal handles.
- Do not use anything with a metal trim.
- Do not use paper covered wire twist-ties on plastic bags.
- Do not use melamine dishes as they contain a material, which will absorb microwave energy. This may cause the dishes to crack or burn, and will slow down the cooking speed.
- Do not cook using a container with a restricted opening, such as bottles, as they may explode.
- Do not heat baby bottles with the teat left on and remove the teat if replacing the bottle back into the oven.
- Only use thermometers that are approved for microwave ovens.
- Do not use the microwave oven for heating utensils.

Non-rewireable mains plug

If your appliance is supplied with a non-rewireable plug fitted to the mains lead you will find that it incorporates a fuse, the value of which is indicated either on the base of the plug or on the fuse carrier. Should the fuse need replacing, you must use an ASTA approved fuse (conforming to BS1362) of the same rating. If the fuse cover is lost the plug must not be used until a replacement is obtained from an electrical supplier. If you need to remove the plug, cut it from the mains lead and dispose of it. Never attempt to re-use this plug or insert it into a socket outlet, as there is a very great risk of an electric shock.

SPECIFICATIONS:

Rated voltage:	230-240V~50Hz,
Operating frequency:	2,450MHz
Microwave input:	1200W
Power output:	900W 1000W (Grill)
Outside Dimensions:	281mm x 483mm x 398mm
Oven capacity dimensions	220mm x 340mm x 320mm
Oven Capacity:	23 Litres
Weight:	Approx. 14.1kg

For Customer Service and
Spare Parts please call

01204 664 084

Opening times:

Monday – Friday

9am until 5pm

Revision 1



This symbol is known as the 'Crossed-out wheellie bin Symbol'. When this symbol is marked on a product/batteries, it means that the product/batteries should not be disposed of with your general household waste. Only discard electrical/electronic/battery items in separate collection schemes, which cater for the recovery and recycling of materials contained within. Your co-operation is vital to make sure the success of these schemes and for the protection of the environment. For your nearest disposal facility, visit www.recycle-more.co.uk or ask in store for details.

We reserve the right due to possible changes to design to alter the instruction manual without prior notice.

For Customer Services & Spare Parts please call **01204 664 084** Opening times: Monday – Friday 9am – 5pm

Free Manuals Download Website

<http://myh66.com>

<http://usermanuals.us>

<http://www.somanuals.com>

<http://www.4manuals.cc>

<http://www.manual-lib.com>

<http://www.404manual.com>

<http://www.luxmanual.com>

<http://aubethermostatmanual.com>

Golf course search by state

<http://golfingnear.com>

Email search by domain

<http://emailbydomain.com>

Auto manuals search

<http://auto.somanuals.com>

TV manuals search

<http://tv.somanuals.com>