

DIM-1

Instruction Manual

Doorbell Interface Module

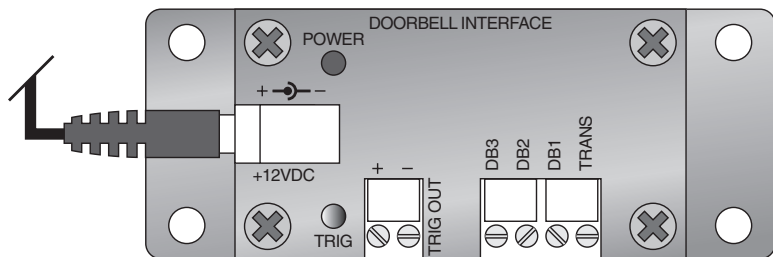

Product Overview

The DIM-1 Doorbell Interface Module's primary purpose is to mute a multi-source/multi-zone audio system so a preexisting doorbell can be heard when it rings. The DIM-1 does not generate an audible chime, but provides a six-second 12V trigger to the multi-zone system which is used to mute the system so the doorbell can be heard. The DIM-1 connects the Russound CA4.4i, CA6.4i, CAV6.6 and the PR-4Zi multi-zone systems to the doorbell of the home by a few simple connections.

Installation Instructions

DIM-1 installation requires an existing doorchime with door button that operates on 12-18VAC or DC. It also requires a 12VDC power supply (Russound 846C, not included).

- 1) Turn off the power to the doorbell transformer and the audio distribution system. You will be making open wire connections to the doorbell.
- 2) The DIM-1 should be located indoors and mounted within 3 feet of the multi-zone audio system and convenient to the electrical outlet that the 12VDC power supply will use. The DIM-1 should be positioned so that the LED indicators can be seen during installation.
- 3) Connect the DIM-1 "TRANS" terminal to the transformer terminal that is connected directly to the doorbell chime module. Connect the doorbell

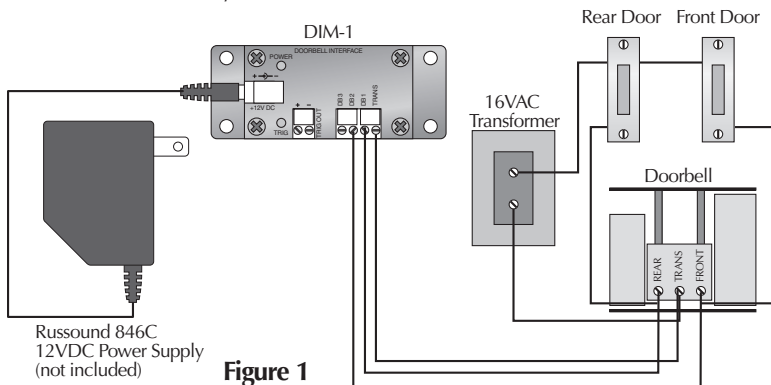

Figure 1

switched contacts at the doorbell chime module to the connections labeled "DB1," "DB2" and "DB3" on the DIM-1. This connects up to 3 separate doorbell buttons to the DIM-1. Refer to Figure 1. Note that the connectors can be unplugged for easy wiring.

- 4) **Connection to Multi-zone System:** The trigger output of the DIM-1 connects to the audio system using a 1/8" mono plug. Connect the mono plug to the controller (see below for specific system connections) and snip off the excess length from the other end of the cable. Strip the two wires from this end and determine which wire comes from the tip by using a continuity meter. The wire from the tip (+) connects to the "TRIG OUT (+)" terminal of the DIM-1. The other wire from the sleeve (-) connects to the "TRIG OUT (-)" of the DIM-1. Refer to Figure 2.

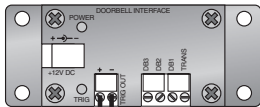
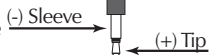

Figure 2



- 4a) **PR-4Zi Connection:** For operation with the PR-4Zi, connect the 1/8" mini plug into the Mute Input connection. Refer to Figure 3.
- 4b) **CAi Series Connection:** For operation with the CA4.4i/CA6.4i, connect the 1/8" mini plug into the Mute Input connection. Refer to Figure 4.
- 4c) **CAV Series Connection:** For operation with the CAV6.6, connect the 1/8" mini plug into the Page Trigger Input connection. Refer to Figure 5.

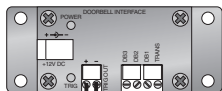
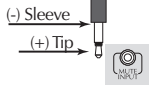

Figure 3



PR-4Zi

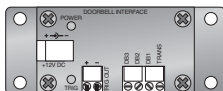
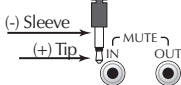

Figure 4



CAi Series

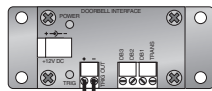
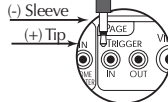

Figure 5



CAV6.6

Operating Instructions

- 1) Power the doorbell system and your audio distribution system.
- 2) Plug the 12VDC power supply into the DIM-1. The red and green LED should be on. After 6 seconds the green LED will go out.
- 3) Ring the doorbell. The green LED on the DIM-1 should illuminate for 6 seconds and then go out.
- 4) Play audio through the audio system.
- 5) Ring the doorbell while the audio is playing. The audio should mute for 6 seconds and then return.

Limited Warranty

The Russound DIM-1 is fully guaranteed against all defects in materials and workmanship for two (2) years from the date of purchase. During this period, Russound will replace any defective parts and correct any defect in workmanship without charge for either parts or labor. For this warranty to apply, the unit must be installed and used according to its written instructions. If service is necessary, it must be performed by Russound. The unit must be returned to Russound at the owner's expense and with prior written permission. Accidental damage and shipping damage are not considered defects, nor is damage resulting from abuse or from servicing by an agency or person not specifically authorized in writing by Russound. This Warranty does not cover: Damage caused by abuse, accident, misuse, negligence, or improper installation or operation; Power surges and lightning strikes; Normal wear and maintenance; Products that have been altered or modified; Any product whose identifying number, decal, serial number, etc. has been altered, defaced or removed. Russound sells products only through authorized Dealers and Distributors to ensure that customers obtain proper support and service. Any Russound product purchased from an unauthorized dealer or other source, including retailers, mail order sellers and online sellers will not be honored or serviced under existing Russound warranty policy. Any sale of products by an unauthorized source or other manner not authorized by Russound shall void the warranty on the applicable product. Damage to or destruction of components due to application of excessive power voids the warranty on those parts. In these cases, repairs will be made on the basis of the retail value of the parts and labor. To return for repairs, the unit must be shipped to Russound at the owner's expense, along with a note explaining the nature of service required. Be sure to pack the unit in a corrugated container with at least three (3) inches of resilient material to protect the unit from damage in transit. Before returning a unit for repair, call Russound at (603) 659-5170 for a Return Authorization number. Write this number on the shipping label and ship to: Russound, ATTN: Service, 5 Forbes Road, Newmarket, NH 03857

Russound®

5 Forbes Rd. Newmarket, NH 03857, USA

☎ 603.659.5170 • Fax 603.659.5388

e-mail: tech@russound.com

Rev. 1 28-1102

Download from www.Somanuals.com. All Manuals Search And Download.

Free Manuals Download Website

<http://myh66.com>

<http://usermanuals.us>

<http://www.somanuals.com>

<http://www.4manuals.cc>

<http://www.manual-lib.com>

<http://www.404manual.com>

<http://www.luxmanual.com>

<http://aubethermostatmanual.com>

Golf course search by state

<http://golfingnear.com>

Email search by domain

<http://emailbydomain.com>

Auto manuals search

<http://auto.somanuals.com>

TV manuals search

<http://tv.somanuals.com>