

RYOBI®

MODEL 2075RC GAS TRIMMER OPERATOR'S MANUAL

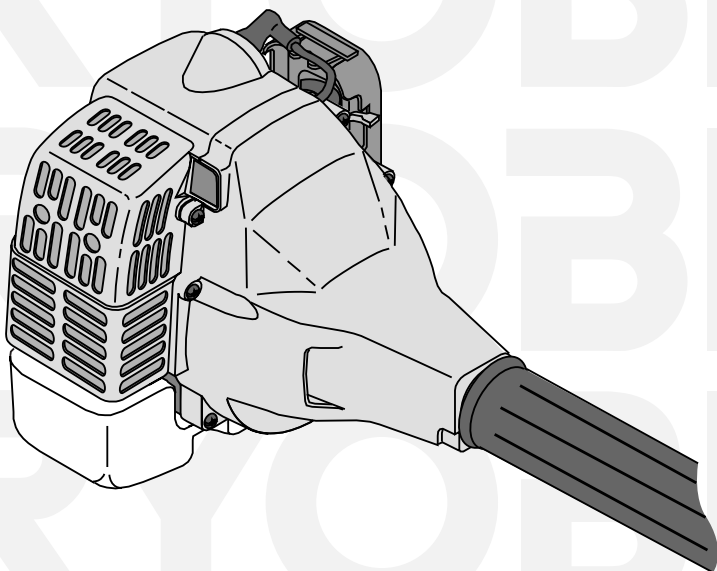

FOR QUESTIONS, CALL 1-800-345-8746 in U.S.
or 1-800-265-6778 in CANADA

IMPORTANT MANUAL

DO NOT THROW AWAY

INTRODUCTION

THANK YOU

Thank you for purchasing this quality product. This modern outdoor power tool is designed to provide many hours of useful service. You will find it to be a great labor-saving device.

This operator's manual provides you with easy-to-understand operating instructions. Read the entire manual and follow all of the instructions to keep your new outdoor power tool in top operating condition.

The other manual that came with your power tool, the parts manual, contains all of the information that you need to order parts.

PRODUCT REFERENCES, ILLUSTRATIONS AND SPECIFICATIONS

All information, illustrations and specifications in this manual are based on the latest product information available at the time of printing. We reserve the right to make changes at any time without notice.

Copyright © 1998 Ryobi Outdoor Products, Inc. All Rights Reserved.

Bump Head™ is a trademark of Ryobi Outdoor Products.

SpeedSpool® is a registered trademark of Ryobi Outdoor Products.

SERVICE INFORMATION

Service on this unit both within and after the warranty period should be performed only by an authorized and approved service dealer. Dial **1-800-345-8746** in the United States and **1-800-265-6778** in Canada to obtain the listing of the authorized service dealer nearest you.

Do not return the unit to the retailer.

NOTE: PROOF OF PURCHASE WILL BE REQUIRED FOR WARRANTY SERVICE.

Make sure this manual is carefully read and understood before starting or operating this equipment.

THIS PRODUCT IS COVERED BY ONE OR MORE OF THE US PATENTS LISTED BELOW:
5,076,149; 4,901,682; 4,779,405; 4,651,422;
4,505,040; 4,463,498; 4,369,742; 4,342,236;
4,223,441; 2,125,688; D-249,012; D-239,329;
OTHER PATENTS PENDING.

TABLE OF CONTENTS

I.	California Emission Regulations	3
II.	Safety Warnings	3-6
	A. Safety and International Symbols . . .	5-6
III.	Assembly Instructions	7
	A. Installing the Loop Handle	7
	B. Installing the String Guard	7
IV.	Oil and Fuel Information	8
V.	Operating Instructions	9-10
	A. Starting/Stopping Instructions	9
	B. Adjusting Trimming Line Length	10
	C. Decorative Trimming	10
VI.	Maintenance and Repair Instructions .	10-15
	A. Maintenance Schedule	10
	B. Line Installation for the SpeedSpool .	11
	C. Winding the Existing Inner Reel with New Line	11
	1. Releasing the Inner Reel	12
	2. Cleaning the SpeedSpool	12
	D. Installing a Prewound Reel	13
	E. Air Filter Maintenance	13
	F. Carburetor Adjustment	14
	G. Replacing the Spark Plug	15
	H. Cleaning and Storage	15
VII.	Troubleshooting Chart	16
VII.	Specifications	17
IX.	Notes	18
X.	Warranty	19

CONTENTS OF CARTON

This unit should consist of the following:

- Model 2075RC Assembled with SpeedSpool Head
- Loop Handle and Hardware
- Handle Bottom Clamp
- String Guard and Hardware
- 4 oz. Bottle of 2-Cycle Oil
- Operator's Manual and Parts Manual
- Owner's Registration/Warranty Card

SPARK ARRESTOR

NOTE: For users on U.S. Forest Land and in the states of California, Maine, Oregon and Washington. All U.S. Forest Land and the state of California (Public Resources Codes 4442 and 4443), Oregon and Washington require, by law that certain internal combustion engines operated on forest brush and/or grass-covered areas be equipped with a spark arrestor, maintained in effective working order, or the engine be constructed, equipped and maintained for the prevention of fire. Check with your state or local authorities for regulations pertaining to these requirements. Failure to follow these requirements could subject you to liability or a fine. **This unit is not factory equipped with a spark arrestor.** If these items are required in your area, ask your LOCAL SERVICE dealer to install the **Optional Accessory Part #181696 Spark Arrestor Kit.**

FOR QUESTIONS, CALL 1-800-345-8746 IN U.S. OR 1-800-265-6778 in CANADA

CALIFORNIA EMISSION REGULATIONS

The engine of your lawn and garden care product meets the 1995 to 1998 California emissions regulations. These units are identified by the label on the engine of your product. A typical identification label is shown.

To ensure that your unit continues to meet these regulations, refer to the following information and instructions in this operator's manual.

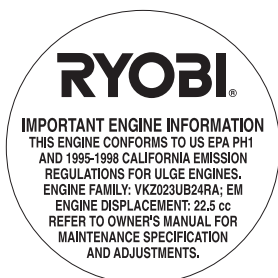

California Proposition 65 Warning:



WARNING



THE ENGINE EXHAUST FROM THIS PRODUCT CONTAINS CHEMICALS KNOWN TO THE STATE OF CALIFORNIA TO CAUSE CANCER, BIRTH DEFECTS OR OTHER REPRODUCTIVE HARM.

SAFETY WARNINGS

THE PURPOSE OF SAFETY SYMBOLS IS TO ATTRACT YOUR ATTENTION TO POSSIBLE DANGERS. THE SAFETY SYMBOLS, AND THE EXPLANATIONS WITH THEM, DESERVE YOUR CAREFUL ATTENTION AND UNDERSTANDING. THE SAFETY WARNINGS DO NOT BY THEMSELVES ELIMINATE ANY DANGER. THE INSTRUCTIONS OR WARNINGS THEY GIVE ARE NOT SUBSTITUTES FOR PROPER ACCIDENT PREVENTION MEASURES.

SYMBOL

MEANING



SAFETY ALERT SYMBOL: Indicates danger, warning, or caution. Special attention is required in order to avoid serious personal injury. May be used in conjunction with other symbols or pictographs.



DANGER: Failure to obey a safety warning will result in serious injury to yourself or to others. Always follow the safety precautions to reduce the risk of fire, electric shock, and personal injury.



WARNING: Failure to obey a safety warning can result in injury to yourself and others.



CAUTION: Failure to obey a safety warning may result in property damage or personal injury to yourself or to others. Always follow the safety precautions to reduce the risk of fire, electric shock, and personal injury.

NOTE: Advises you of information or instructions vital to the operation or maintenance of the equipment.

SAFETY WARNINGS

• IMPORTANT SAFETY INFORMATION •

READ ALL INSTRUCTIONS

BEFORE OPERATING

- Read the instructions carefully. Be familiar with the controls and proper use of the unit.
- Children and adolescents must not manipulate units, except for adolescents in training and under the supervision of a specialist.
- All guards and safety attachments must be installed properly before operating the unit.
- Thoroughly inspect the unit for loose or damaged parts before each use. Do not use until adjustments or repairs are made.
- Carefully inspect the areas to be cut. Remove all debris that could become entangled in the string or blade. Also remove any objects that could be thrown during cutting.
- Be aware of the risk of injury to the head, hands and feet.

SAFETY WARNINGS FOR GAS TRIMMERS

WARNING: Gasoline is highly flammable and its vapors can explode if ignited. Take the following precautions:

- 1) Store fuel only in containers specifically designed and approved for the storage of such materials.
- 2) Always stop the engine and allow it to cool before filling the fuel tank. Never remove the cap of the fuel tank, or add fuel, when the engine is hot.
- 3) Pressure can build up in the fuel tank. Loosen the fuel tank cap slowly to relieve any pressure in the tank.
- 4) Add fuel in a clean, well-ventilated area. Wipe up any spilled fuel immediately. If fuel has been spilled, avoid creating a source of ignition or starting the engine until fuel vapors have dissipated.
- 5) Ensure correct fuel or fuel/oil mixture is used. Never operate the unit without the fuel cap securely in place.
- 6) Move the unit at least 10 feet (3 m) from the fueling point before starting the engine. Do not smoke, keep sparks and open flames away from the area while adding fuel or operating the unit.

WHILE OPERATING

- Wear safety glasses or goggles and ear/hearing protection at all times when operating this unit. Always wear a face or dust mask if the operation is dusty.
- Dress properly. Do not operate this unit when barefoot or wearing open sandals. Always wear sturdy, rubber-soled footwear. The use of gloves and long pants are recommended.
- Do not wear loose fitting clothing or articles such as scarves, strings, chains, ties, etc. because they could get drawn into the air intake. Also make sure long hair does not get drawn into the air intake. Long hair must be pulled back and secured off shoulders and neck.
- The string guard must be in place at all times while operating the unit.
- Before each use, check that the cutting head is correctly fixed, that the trigger returns automatically in neutral position, and that the cutting head remains stationary when the engine is idling.
- Before starting, adjust the handle to your size and make sure that the cutting head is not in contact with anything.
- Use the unit only in daylight or good artificial light.
- Operate this unit only in a well-ventilated area outdoors. Carbon monoxide exhaust fumes can be lethal in a confined area.
- Avoid accidental starting. Be in the starting position whenever pulling the starting rope. The operator and unit must be in a stable position while starting.
- Use the right tool. Do not use this unit for any job except for which it is intended.
- Do not overreach. Keep proper footing and balance at all times.
- Always hold the unit with both hands when operating. Keep a firm grip on both the front and rear handles or grips.
- Keep hands, face, and feet away from all moving parts. Do not attempt to touch or stop the cutting head when it is rotating.
- Do not touch the muffler or cylinder. These parts get extremely hot from operation and remain hot for a short time after the equipment is turned off.

SAFETY WARNINGS

- Keep all bystanders, especially children and pets, at least 30 feet (9.1 m) away from the unit during operation.
- Do not operate the engine faster than the speed necessary to cut, trim or edge. Do not run the engine at high speed when not cutting.
- Always stop the engine when cutting is delayed or when walking from one cutting location to another.
- Do not operate unit without both trimming lines extended, and the proper line installed.
- Do not extend the trimming line beyond the length of the guard as specified in this manual.
- If you strike or become entangled with a foreign object, stop the engine immediately and check for damage. Repair any damage before further operation is attempted. Do not operate the unit with loose or damaged parts.
- Frequently inspect the condition of the cutting head. All damaged parts must be replaced immediately. Follow all the required precautions when undertaking replacement.
- All interventions, whether for maintenance, repair or for changing cutting head or safety attachments, must be undertaken with the engine/motor stopped.
- Use only genuine replacement parts when servicing this unit. These parts are available from your authorized dealer. The use of non-standard parts, or other accessories or attachments not designed for this unit, could result in serious injury to the user or damage to the unit and void your warranty.
- Keep unit clean of vegetation and other materials. They may become lodged between the cutting head and guard mount.
- To reduce fire hazard, replace faulty mufflers and spark arrestors, keep the engine and muffler free of grass, leaves, excessive grease or carbon buildup.





OTHER SAFETY WARNINGS

- Never store the unit, with fuel in the tank, inside a building where fumes may reach an open flame or spark.
- Allow the engine to cool before storing in an enclosure.
- Lock up and store the unit in an appropriate and dry location to prevent unauthorized use and damage.
- Keep these instructions. Refer to them frequently and use them to instruct other users. If you loan someone this unit, also loan them these instructions.











SAVE THESE INSTRUCTIONS

SAFETY AND INTERNATIONAL SYMBOLS

This operator's manual describes safety and international symbols and pictographs that may appear on this product. Read the operator's manual for complete safety, assembly, operating and maintenance and repair information.

SYMBOL	MEANING
	<ul style="list-style-type: none"> • SAFETY ALERT SYMBOL Indicates danger, warning, or caution. May be used in conjunction with other symbols or pictographs.
	<ul style="list-style-type: none"> • READ OPERATOR'S MANUAL Failure to follow operating instructions and safety precautions in operator's manual can result in serious injury. Read operator's manual before starting or operating this unit.
	<ul style="list-style-type: none"> • FOR SERVICE INFORMATION, CALL: USA: 1-800-345-8746 CANADA: 1-800-265-6778
	<ul style="list-style-type: none"> • WEAR EYE AND HEARING PROTECTION WARNING: Thrown objects and loud noise can cause severe eye injury and hearing loss. Wear eye and ear protection when operating this unit.

SAFETY WARNINGS

SYMBOL	MEANING
	<ul style="list-style-type: none"> • KEEP BYSTANDERS AWAY <p>WARNING: Keep all bystanders, especially children and pets, at least 30 feet (9.1 m) away from the trimming area.</p>
	<ul style="list-style-type: none"> • PRIMER BULB <p>Push primer bulb, fully and slowly, 5 to 7 times.</p>
	<ul style="list-style-type: none"> • UNLEADED FUEL <p>Always use clean, fresh unleaded fuel.</p>
	<ul style="list-style-type: none"> • INDICATES OIL <p>Refer to operator's manual for the proper type of oil.</p>
	<ul style="list-style-type: none"> • CHOKE CONTROL <ul style="list-style-type: none"> • "START" position (A). • "RUN" position (B).
	<ul style="list-style-type: none"> • THROWN OBJECTS AND ROTATING CUTTER CAN CAUSE SEVERE INJURY <p>WARNING: Do not operate unit as a trimmer without string guard in place. Keep away from rotating cutter.</p>
	<ul style="list-style-type: none"> • IGNITION SWITCH <p>ON / START / RUN</p>
	<ul style="list-style-type: none"> • IGNITION SWITCH <p>OFF or STOP</p>
	<ul style="list-style-type: none"> • HOT SURFACE WARNING <p>Do not touch a hot muffler, gear box or cylinder. You may get burned. These parts get extremely hot from operation and remain hot for a short time after the unit is turned off.</p>
	<ul style="list-style-type: none"> • ROTATING CUTTER CAN CAUSE SEVERE INJURY <p>WARNING: Stop engine/motor and disconnect lower drive shaft from unit prior to making adjustments, removing, or cleaning.</p>

ASSEMBLY INSTRUCTIONS

INSTALLING AND ADJUSTING THE LOOP HANDLE

If the loop handle is not assembled on this model, use the following instructions:

1. Place the loop handle and bottom handle clamp on the boom shaft (Fig. 1).
2. Install, **one at a time**, the four (4) screws and four (4) hex nuts with a Phillips screwdriver.

NOTE: Install all four (4) screws before you tighten any of them.

3. Adjust the loop handle to the desired position.
4. Tighten the clamp screws securely.

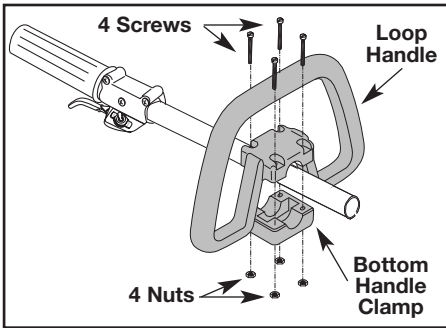

Fig. 1

INSTALLING THE STRING GUARD

If the string guard is not assembled on this model, use the following instructions:



WARNING: To avoid serious personal injury, the string guard must be in place while operating this unit.

1. Slide the string guard onto the guard mount above the string head assembly. Align the screw holes in the string guard with the screw holes in the string assembly (Fig. 2).

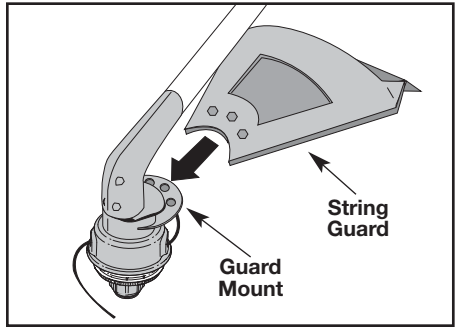

Fig. 2

2. Place the three hex nuts into the recessed holes on top of the guard (Fig. 3).

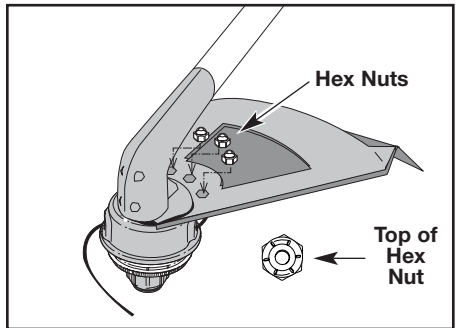

Fig. 3

3. Install the screws into the holes from the bottom of the guard (Fig. 4).

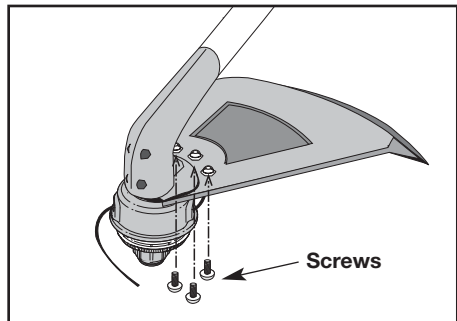

Fig. 4

OIL AND FUEL INFORMATION

Old or improperly mixed fuel are usually the main reasons for the unit not running properly. Be sure to use fresh, clean fuel and follow the instructions carefully for the proper fuel/oil mixture.

NOTE: Alcohol-blended fuel absorbs moisture (water). As little as 1% moisture in the fuel can cause fuel and oil to separate and form acids when stored. If this type of fuel must be used, use fresh fuel (less than 60 days old), and mix according to the mixing instructions.

DEFINITION OF BLENDED FUELS

Today's fuels are often a blend of gasoline and one or more oxygenates such as ethanol, methanol or MTBE (ether).

USE OF BLENDED FUELS

If you choose to use a blended fuel or its use is unavoidable, the following precautions are recommended.

1. Always use fresh fuel mix per your operator's manual.
2. Use the special additive STA-BIL® or an equivalent.
3. Always agitate the fuel mix before fueling the unit.
4. Drain the tank and run the engine dry before storing the unit.



WARNING: Gasoline is extremely flammable and its vapors can explode if they are ignited. To avoid serious personal injury, always stop the engine and allow it to cool before filling the fuel tank. Do not smoke while filling the tank. Keep sparks and open flames away from the area.



WARNING: Pressure can build up in the fuel tank. Loosen the fuel tank cap slowly to relieve any pressure in the tank.

USE OF FUEL ADDITIVES



The use of fuel additive, such as STA-BIL® Gas Stabilizer or an equivalent, will inhibit corrosion and minimize the formation of gum deposits. Add 0.8 oz (23 ml) per gallon of fuel per instructions on container. NEVER add fuel additives directly to the unit's fuel tank. Using a fuel additive can keep fuel fresh for up to six (6) months.



CAUTION: For proper engine operation and maximum reliability, pay strict attention to the oil and fuel mixing instructions on the 2-cycle oil container. Use a 32:1 fuel/oil ratio. Use 2-cycle oil. Using improperly mixed fuel can severely damage the engine.

OIL AND FUEL MIXING INSTRUCTIONS

Thoroughly mix the proper ratio of 2-cycle engine oil with unleaded gasoline in a separate fuel can, 32:1. Do not mix them directly in the engine fuel tank. See the table below for specific gas and oil mixing ratios.

 UNLEADED GAS	+	 RYOBI OIL
1 U.S. GALLON (3.8 liters)	+	4.0 fl. oz. (118 ml)
1 LITER	+	30 ml
MIXING RATIO - 32:1		

OPERATING INSTRUCTIONS

STARTING/STOPPING



WARNING: Operate this unit only in a well-ventilated area outdoors. Carbon monoxide exhaust fumes can be lethal in a confined area.



WARNING: Avoid accidental starting. Be in the starting position whenever pulling the starter rope. To avoid serious personal injury, the operator and unit must be in a stable position while starting.

1. **MIX OIL WITH GAS AND FILL FUEL TANK WITH FUEL/OIL MIXTURE** per instructions on page 8.
2. Put the **IGNITION SWITCH IN THE "ON" POSITION** (Fig. 5).
3. **FULLY PRESS AND RELEASE THE PRIMER BULB 5 TO 7 TIMES. FUEL SHOULD BE VISIBLE IN THE BULB** (Fig. 6).
4. **PLACE THE CHOKE LEVER IN THE "START" POSITION (A)** (Fig. 6).
5. **WITH THE UNIT ON THE GROUND, SQUEEZE THE THROTTLE TRIGGER FULLY AND PULL THE STARTER ROPE BRISKLY** (Fig. 7) until the engine sounds like it wants to run (normally 2 to 5 pulls).

NOTE: Keep the throttle trigger depressed at all times until the engine is warmed up.

6. **PLACE THE CHOKE LEVER IN THE "RUN" POSITION (B)** (Fig. 6).
7. **PULL THE STARTER ROPE BRISKLY 1 TO 3 TIMES TO START THE ENGINE** (Fig. 7).
8. If the engine does not start, repeat steps 4 through 7.

NOTE: If the engine floods while attempting to start the unit, place the choke lever in the "RUN" position (B), squeeze the throttle trigger, and pull the starter rope briskly. The engine should start within three (3) to eight (8) pulls.

9. Keep throttle trigger depressed for 5 to 10 seconds to warm up engine.

NOTE: Choking is not required when starting a warm engine. Start a warm engine in the "RUN" POSITION.

10. To stop the engine, put the **IGNITION SWITCH IN THE "OFF" POSITION** (Fig. 5).

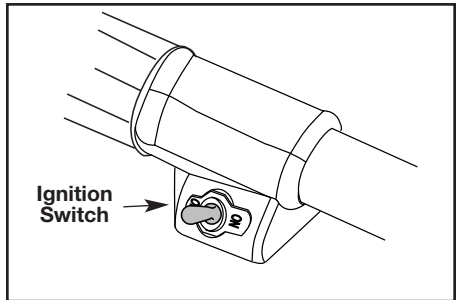

Fig. 5

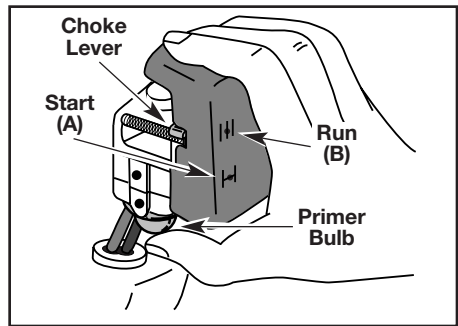

Fig. 6



Fig. 7

OPERATING INSTRUCTIONS

ADJUSTING TRIMMING LINE LENGTH

Your unit is equipped with a cutting head that allows the operator to release more trimming line without stopping the engine. To release additional line, lightly tap the cutting head on the ground (Fig. 8) while operating the unit at high speed.

NOTE: Always keep the trimming line fully extended. Line release becomes more difficult as cutting line becomes shorter.

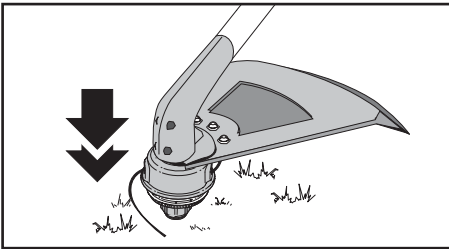

Fig. 8

Each time the head is bumped, about 1 inch (25.4 mm) of trimming line is released. A blade in the string guard will cut the line to the proper length if excess line is released.

For best results, tap the head on bare ground or hard soil. If line release is attempted in tall grass, the engine may stall.

DECORATIVE TRIMMING

Decorative trimming is accomplished by removing all vegetation around trees, posts, fences, etc.

Rotate the entire unit so that the cutting head is at a 30° angle to the ground (Fig. 9).

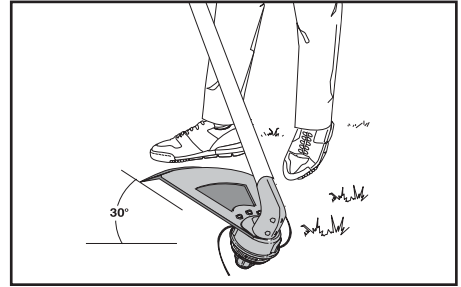

Fig. 9



CAUTION: Do not remove or alter the line cutting blade assembly. Excessive line length will cause clutch to overheat and may result in serious personal injury.

MAINTENANCE AND REPAIR INSTRUCTIONS

MAINTENANCE SCHEDULE

These required maintenance procedures should be performed at the frequency stated in the table. They should also be included as part of any seasonal tune-up.



WARNING: Never perform maintenance or repairs with unit running. Always perform maintenance and repairs on a cool unit. Disconnect spark plug wire to make sure the unit will not start.

FREQUENCY	MAINTENANCE REQUIRED	REFER TO:
Daily or Before Starting Engine	Fill fuel tank with correct oil and fuel mixture.	Page 8
Every 10 Hours	Clean and re-oil air filter.	Pages 13-14
Every 50 Hours	Check spark plug condition and gap.	Page 15

MAINTENANCE AND REPAIR INSTRUCTIONS

LINE INSTALLATION FOR THE SPEEDSPOOL®

The trimming line in the speed spool may be replaced by two different methods.

- Winding the existing inner reel with new line
- Installing a prewound inner reel

TO INSTALL NEW TRIMMING LINE, IT IS NOT NECESSARY TO REMOVE THE BUMP KNOB.

The Correct Line to Use



WARNING: Always use genuine Ryobi replacement line. **Do not use metal-reinforced line.**

It is very important to use the correct size line. **Use line with a diameter of 0.080 in (2.03 mm).** The motor may overheat and fail if you use a larger line.

WINDING THE EXISTING INNER REEL WITH NEW LINE

NOTE: Before installing new trimming line onto the existing inner reel, remove any old line from the SpeedSpool by pulling the line out of the line loading or locking holes (Figs. 11 and 12).

1. Line up the arrow on the inner reel with the arrow on the outer spool (Fig. 10).



WARNING: Always use the correct line length when installing trimming line on the unit. If longer line is used than specified in this manual, the line may not release properly.

TOP VIEW OF THE SPEEDSPOOL

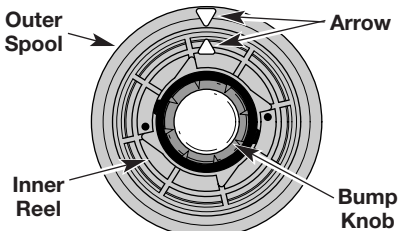

Fig. 10

NOTE: Do not wind the inner reel before the second line is installed into the reel.

2. Insert **10 feet (2.5 m) of .080 in (2.03 mm) trimming line** into one of the two eyelets and push it up through the line loading hole in the inner reel (Fig. 11). Do not bend the line when inserting it into the eyelet.

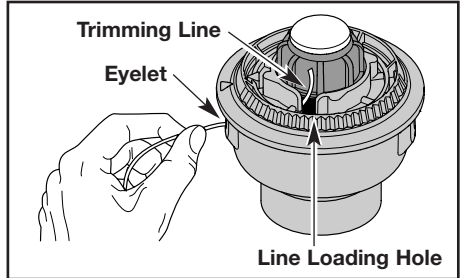

Fig. 11

3. Insert the line into the locking hole (Fig. 12) no more than 1/2 inch (12.7 mm). Do not push the line too far into the inner reel. A small loop is formed when the line is inserted correctly (Fig. 12).

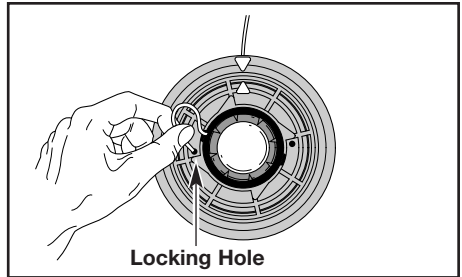

Fig. 12

4. Pull the line away from the spool until the line is tight against the inner reel (Fig. 13).

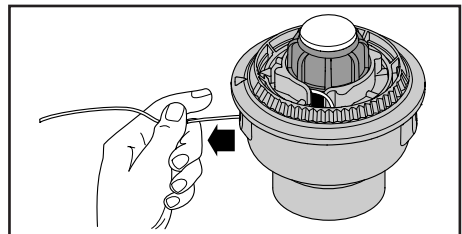

Fig. 13

MAINTENANCE AND REPAIR INSTRUCTIONS

5. Repeat the procedure with the second eyelet and use the same amount of line as specified in Step 2.
6. Wind the inner reel counterclockwise until approximately four (4) inches of line remains outside of the eyelets in the outer spool (Fig. 14).

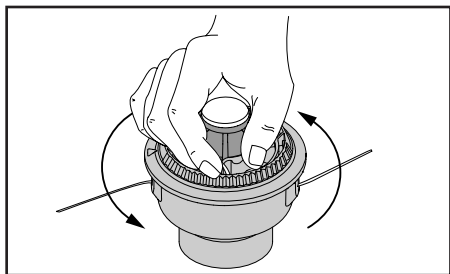

Fig. 14

7. If winding the line becomes difficult or the line jams, pull the ends of the line away from the spool and continue winding the inner reel counterclockwise (Fig. 15).

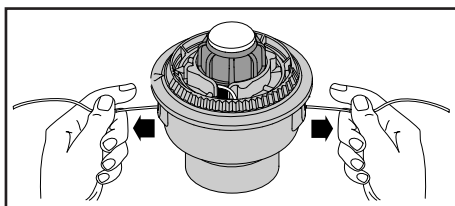

Fig. 15

Releasing the Inner Reel

If the SpeedSpool does not operate correctly when bumping the head on the ground, use the following instructions.

Pull the ends of the line firmly away from the spool to release the inner reel (Fig. 15). If this procedure does not release the inner reel, follow the "Cleaning the SpeedSpool" instructions below.

Cleaning the SpeedSpool

If the SpeedSpool becomes difficult to wind or does not operate correctly when bumping the head on the ground, use the following instructions.

1. If you need to remove the Bump Knob to clean the spool or remove jammed, excess line, hold the outer spool, and unscrew the Bump Knob counterclockwise (Fig. 16).

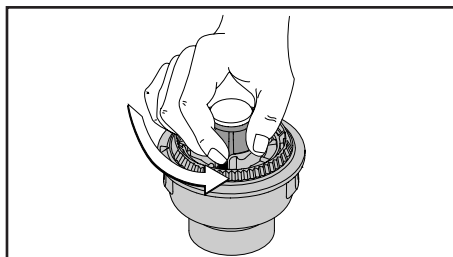

Fig. 16

2. Remove the Bump Knob, foam seal, spring, inner reel, and trimming line from the outer spool (Fig. 17).

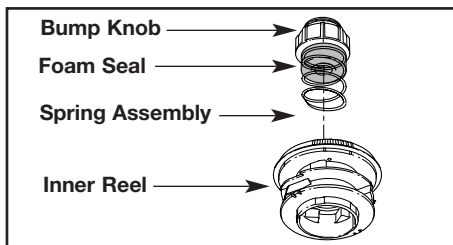

Fig. 17

3. Remove any debris or grass from the knob, spring, inner reel, and foam seal. Remove any existing line from the inner reel before cleaning. Wash the inner reel with warm soapy water (Fig. 18).

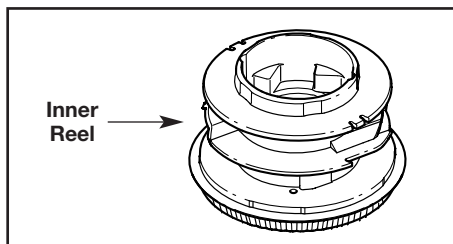

Fig. 18

MAINTENANCE AND REPAIR INSTRUCTIONS

NOTE: The inner reel must be completely dry before reinstalling it into the outer spool. Do not lubricate the inner reel or outer spool assembly.

4. Clean the shaft and the inner surface of the outer spool. To clean the shaft underneath the plunger, press down on the plunger (Fig. 19). Remove any dirt and/or debris from the shaft.

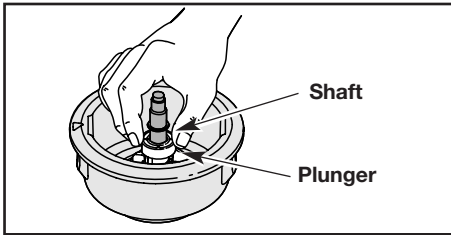

Fig. 19

5. Install the inner reel, spring, foam seal, and Bump Knob into the outer spool (Fig. 17).
6. Tighten the Bump Knob clockwise.
7. Install new line as described in **Line Installation for the SpeedSpool**.

INSTALLING A PREWOUND REEL

1. Insert the ends of the two trimming lines into the eyelets in the outer spool (Fig. 20), then grasp the ends and pull firmly to release the line from the holding slots in the outer spool.
2. Hold the inner reel in place and install the Bump Knob, spring and foam seal in the counterclockwise direction. Line installation is now complete.

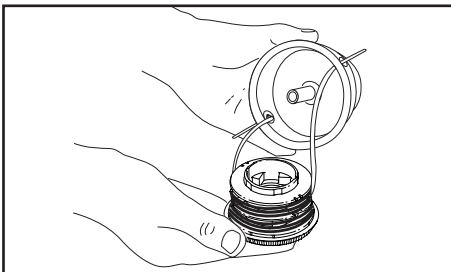

Fig. 20

AIR FILTER MAINTENANCE

CLEAN AND RE-OIL THE AIR FILTER EVERY 10 HOURS OF OPERATION. Your unit's air filter is one of the most important areas to maintain. If it is not maintained, you will void the warranty. Before cleaning, make sure the unit is turned off.

1. Remove the carburetor/air filter cover by pushing on the tab on top of the cover (Fig. 21).

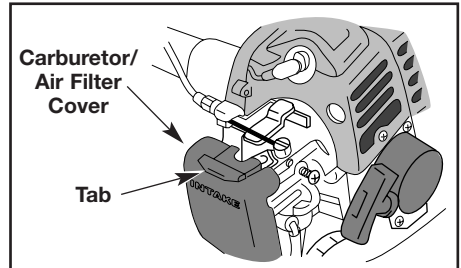

Fig. 21

2. Remove the air filter (Fig. 22).

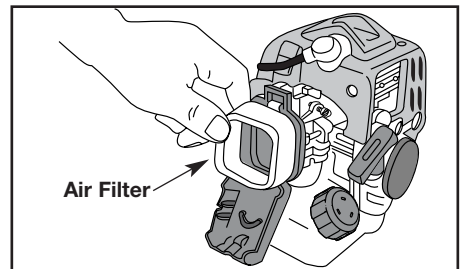

Fig. 22

3. Wash the filter in detergent and water (Fig. 23). Rinse the filter thoroughly and allow it to dry.

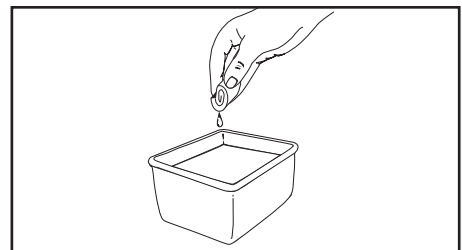

Fig. 23

MAINTENANCE AND REPAIR INSTRUCTIONS

4. Apply enough clean motor oil to lightly coat the filter (Fig. 24).

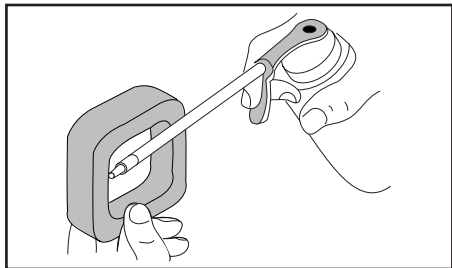

Fig. 24

5. Squeeze the filter to spread and remove excess oil (Fig. 25).
6. Reinstall the filter (Fig. 22) and air filter cover.

NOTE: If the unit is operated without the carburetor/air filter cover assembled, you will **VOID** the warranty.

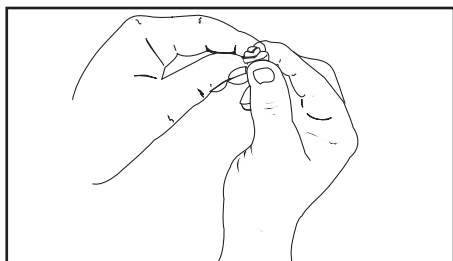

Fig. 25

CARBURETOR ADJUSTMENT

This unit is equipped with a diaphragm-type carburetor that has been carefully calibrated at the factory. In most cases, no further adjustment is required.

Old or improperly mixed fuel are usually the main reasons for the unit not running properly. Drain and refill the tank with fresh properly mixed fuel prior to doing any adjustments. Refer to **Oil and Fuel Information** for the proper ratio.

The condition of the air filter is important to the operation of the unit. A dirty air filter will restrict the air flow, which upsets the fuel-air mixture in the carburetor. The resulting symptoms are often mistaken for an out-of-adjustment carburetor. Therefore, check the condition of the air filter before adjusting the carburetor. Refer to **Air Filter Maintenance**.

If the following conditions are experienced, it may be necessary to adjust the carburetor:

- The engine will not idle
- The engine hesitates or stalls on acceleration
- A loss of engine power that is not corrected by new fuel or cleaning the air filter and muffler

NOTE: Warm up the engine for 30-60 seconds before adjusting the carburetor.

Adjusting Carburetor

1. Clean the air filter if it is dirty. Refer to **Air Filter Maintenance**.
2. Fill the tank with clean, properly mixed fuel. Refer to **Oil and Fuel Information**.
3. If the engine stops frequently when idling, turn the idle speed screw **clockwise** 1/2 turn until the engine stabilizes (Fig. 26).
4. If the cutting head keeps rotating after the trigger is released, turn the idle speed screw **counterclockwise** 1/2 turn until the head stops rotating (Fig. 26).

NOTE: Careless adjustments can seriously damage your unit. It is recommended that carburetor adjustments be made by an authorized service dealer.

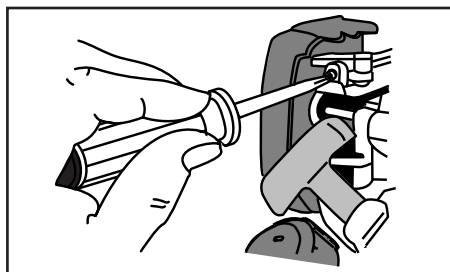

Fig. 26

MAINTENANCE AND REPAIR INSTRUCTIONS

REPLACING THE SPARK PLUG

Use a Champion RCJ-6Y spark plug (or equivalent). Correct air gap is **0.025 in. (0.655 mm)**. Remove plug after **every 50 hours of operation** and check its condition.

1. Stop the engine and allow it to cool. Pull the wire off of the spark plug.
2. Clean around the spark plug and remove it from the cylinder head. Use a 5/8" socket to remove the plug.



CAUTION: Replace a cracked, fouled or dirty spark plug. Do not sand blast, scrape, or clean electrodes because the engine could be damaged by grit entering the cylinder.

3. Set the air gap at **0.025 in. (0.655 mm)** using a wire feeler gauge (Fig. 27). Install a correctly gapped spark plug into the cylinder head. Torque to **110-120 in•lb (12.3-13.5 N•m)**.

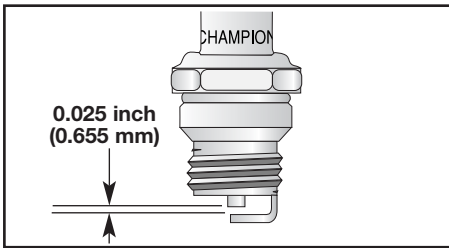

Fig. 27

CLEANING



WARNING: Always turn off your trimmer before you clean or perform any maintenance on it.

Use a small brush to clean off the outside of the unit. Do not use strong detergents on plastic housing or handle. They can be damaged by household cleaners that contain aromatic oils such as pine and lemon, and by solvents such as kerosene. Wipe off any moisture with a soft cloth.

STORAGE

If the unit will be stored for an extended period of time, use the following storage procedure.

1. Drain all fuel from the fuel tank and drain into a container with the same 2-cycle fuel mixture. **Do not use fuel that has been stored for more than 60 days.** Dispose of the old fuel/oil mix in a safe manner and use a fresh mix.
2. Start the engine and allow it to run until it stalls. This ensures that all fuel has been drained from the carburetor.
3. Allow the engine to cool. Remove the spark plug and put approximately 1 oz (30 ml) of any high quality motor oil or 2-cycle oil into the cylinder. Pull the starter rope slowly to distribute the oil. Reinstall the spark plug.
4. Thoroughly clean the unit and inspect for any loose or damaged parts. Repair or replace damaged parts and tighten loose screws, nuts or bolts. The unit is now ready for storage.
5. To prevent unauthorized use or damage, lock up and store the unit in a dry, well-ventilated area.

NOTE: Remove the spark plug and drain all of the oil from the cylinder before attempting to start the trimmer after storage.

ACCESSORIES/REPLACEMENT PARTS

2-Cycle Oil.	147543
Spark Plug	181765
Replacement Line	181472
Replacement Line Cartridge	181460
Inner Reel Spring	181465
Bump Head Knob Assembly.	181468
Fuel Cap.	180000
Shoulder Strap	682075

TROUBLESHOOTING

PROBLEM	CAUSE	ACTION
Engine will not start	Ignition switch is "OFF" Empty fuel tank Primer bulb wasn't pressed enough Engine flooded Old or Improperly Mixed Fuel	Turn switch to "ON" Fill fuel tank Press primer bulb fully and slowly 5-7 times Use starting procedure WITHOUT USING CHOKE Drain fuel tank / Add fresh fuel mixture
Fouled spark plug	Excessive oil in oil/fuel mixture or Old Fuel	Replace spark plug / Drain fuel tank / Add fresh fuel mixture
Engine will not idle	Carburetor misadjusted Old or Improperly Mixed Fuel	Adjust carburetor Drain fuel tank / Add fresh fuel mixture
Engine will not accelerate	Old or Improperly Mixed Fuel Cutting head bound with grass	Drain fuel tank / Add fresh fuel mixture Stop engine and clean cutting head
Engine lacks power or stalls when cutting	Throttle wire has come loose Dirty air filter No oil in fuel or Old Fuel Carburetor misadjusted Cutting head bound with grass Muffler plugged	Tighten throttle wire Clean or replace air filter Drain fuel tank / Add fresh fuel mixture Adjust carburetor Stop engine and clean cutting head Clean or replace muffler (contact authorized service dealer)
Cutting head will not advance line	Cutting head out of line Inner reel bound up Cutting head dirty Line welded Line twisted when refilled Not enough line is exposed	Refill with new line Replace inner reel Clean inner reel and outer spool Disassemble, remove the welded section and rewind the line Disassemble and rewind line Push the Bump Knob and pull out line until 4 in (102 mm) of line is outside of the cutting head
Cutting line advances uncontrollably	Oil in cutting head	Clean cutting head

If further assistance is required, contact your authorized service dealer.

SPECIFICATIONS

ENGINE

Engine Type	Air-Cooled, 2-Cycle
Displacement	1.4 cu. in. (22.5 cc)
Clutch Type	Centrifugal
Operating RPM	6,500-8,000 rpm
Idle Speed RPM	2,600-3,400 rpm
Ignition Type	Electronic
Ignition Switch	Toggle Switch
Spark Plug Gap	0.025 inch (0.655 mm)
Lubrication	Fuel/Oil Mixture
Fuel/Oil Ratio	32:1
Carburetor	Diaphragm, All-Position
Starter	Auto Rewind
Muffler	Baffled with Guard
Throttle	Manual Spring Return
Fuel Tank Capacity	20 oz (591 ml)
Fuel Tank	HD Polyethylene

DRIVE SHAFT & CUTTING HEAD

Drive Shaft Housing	Aluminum Tube
Throttle Control	Finger-Tip Trigger
Operating Weight	11 lbs (4.989 kg)
Cutting Mechanism	String Cutting Head
Shoulder Strap	Optional
Line Spool	SpeedSpool
Line Spool Diameter	3 inches (76.2 mm)
Trimming Line Diameter	0.080 inches (2.03 mm)
Cutting Path Diameter	16 inches (40.64 cm)

NOTES

CALIFORNIA EMISSION CONTROL WARRANTY STATEMENT YOUR WARRANTY RIGHTS AND OBLIGATIONS

The California Air Resources Board and Ryobi Outdoor Products (ROP), is pleased to explain the emission control system warranty on your 1995 and later lawn and garden equipment engine. In California, new lawn and garden equipment engines must be designed, built and equipped to meet the State's stringent anti-smog standards. ROP must warrant the emission control system on your lawn and garden equipment engine for the periods of time listed below provided there has been no abuse, neglect or improper maintenance of your lawn and garden equipment engine.

Your emission control system may include parts such as the carburetor or fuel injection system, the ignition system, and catalytic converter. Also included may be hoses, belts, connectors and other emission-related assemblies.

Where a warrantable condition exists, ROP will repair your lawn and garden equipment engine at no cost to you including diagnosis, parts and labor.

The 1995 and later utility and lawn and garden equipment engines are warranted for two years. If any emission-related part on your engine is defective, the part will be repaired or replaced by ROP.

OWNER'S WARRANTY RESPONSIBILITIES:

- As the lawn and garden equipment engine owner, you are responsible for the performance of the required maintenance listed in your operator's manual. ROP recommends that you retain all receipts covering maintenance on your lawn and garden equipment engine, but ROP cannot deny warranty solely for the lack of receipts or for your failure to ensure the performance of all scheduled maintenance.
- As the lawn and garden equipment engine owner, you should however be aware that ROP may deny you warranty coverage if your lawn and garden equipment engine or a part has failed due to abuse, neglect, improper maintenance or unapproved modifications.
- You are responsible for presenting your lawn and garden equipment engine to a Ryobi Authorized Service Center as soon as a problem exists. The warranty repairs should be completed in a reasonable amount of time, not to exceed 30 days.

If you have any questions regarding your warranty rights and responsibilities, you should call 1-800-345-8746.

MANUFACTURER'S WARRANTY COVERAGE:

- The warranty period begins on the date the engine or equipment is delivered to the retail purchaser.
- The manufacturer warrants to the initial owner and each subsequent purchaser, that the engine is free from defects in material and workmanship which cause the failure of a warranted part for a period of two years.
- Repair or replacement of warranted part will be performed at no charge to the owner at an Authorized Ryobi Service Center. For the nearest location, please contact Ryobi at: 1-800-345-8746.
- Any warranted part which is not scheduled for replacement, as required maintenance which is scheduled only for regular inspection to the effect of "Repair or replace as necessary" is warranted for the warranty period. Any warranted part which is scheduled for replacement as required maintenance will be warranted for the period of time up to the first scheduled replacement point for that part.
- The owner will not be charged for diagnostic labor which leads to the determination that a warranted part is defective, if the diagnostic work is performed at an Authorized Ryobi Service Center.
- The manufacturer is liable for damages to other engine components caused by the failure of a warranted part still under warranty.
- Failures caused by abuse, neglect or improper maintenance are not covered under warranty.
- The use of add-on or modified parts can be grounds for disallowing a warranty claim. The manufacturer is not liable to cover failures or warranted parts caused by the use of add-on or modified parts.
- In order to file a claim, go to your nearest Authorized Ryobi Service Center. Warranty services or repairs will be provided at all Authorized Ryobi Service Centers.
- Any manufacturer approved replacement part may be used in the performance of any warranty maintenance or repair of emission related parts and will be provided without charge to the owner. Any replacement part that is equivalent in performance or durability may be used in non-warranty maintenance or repair and will not reduce the warranty obligations of the manufacturer.
- The following components are included in the emission related warranty of the engine, air filter, carburetor, primer, fuel lines, fuel pick up/fuel filter, ignition module, spark plug and muffler.

LIMITED TWO-YEAR WARRANTY

RYOBI OUTDOOR PRODUCTS warrants each new RYOBI Product for two (2) years according to the following terms.

This warranty extends to the original retail purchaser only and commences on the date of original retail purchase.

Any part of the RYOBI Product manufactured or supplied by RYOBI and found in the reasonable judgement of RYOBI to be defective in material or workmanship will be repaired or replaced by an authorized RYOBI service dealer without charge for parts and labor.

The RYOBI Product including any defective part must be returned to an authorized service dealer within the warranty period. The expense of delivering the RYOBI Product to the dealer for warranty work and the expense of returning it back to the owner after repair or replacement will be paid for by the owner. RYOBI's responsibility in respect to claims is limited to making the required repairs or replacements and no claim of breach of warranty shall be cause for cancellation or rescission of the contract of sale of any RYOBI Product. Proof of purchase will be required by the dealer to substantiate any warranty claim. All warranty work must be performed by an authorized RYOBI service dealer.

This warranty is limited to ninety (90) days from the date of original retail purchase for any RYOBI Product that is used for rental or commercial purposes, or any other income-producing purpose.

This warranty does not cover any RYOBI Product that has been subject to misuse, neglect, negligence, or accident, or that has been operated in any way contrary to the operating instructions as specified in the RYOBI Operator's Manual. This warranty does not apply to any damage to the RYOBI Product that is the result of improper maintenance or to any RYOBI Product that has been altered or modified so as to adversely affect the product's operation, performance or durability or that has been altered or modified so as to change its intended use. The warranty does not extend to repairs made necessary by normal wear or by the use of parts or accessories which are either incompatible with the RYOBI Product or adversely affect its operation, performance or durability.

In addition, this warranty does not cover:

- A. Tune-ups - Spark Plugs, Carburetor Adjustments, Filters
- B. Wear items - Bump Knobs, Outer Spools, Cutting Line, Inner Reels, Starter Pulley, Starter Ropes, Drive Belts

RYOBI reserves the right to change or improve the design of any RYOBI Product without assuming any obligation to modify any product previously manufactured.

ALL IMPLIED WARRANTIES ARE LIMITED IN DURATION TO THE TWO (2) YEAR WARRANTY PERIOD OR NINETY (90) DAYS FOR PRODUCTS USED FOR ANY COMMERCIAL PURPOSE. ACCORDINGLY, ANY SUCH IMPLIED WARRANTIES INCLUDING MERCHANTABILITY, FITNESS FOR A PARTICULAR PURPOSE, OR OTHERWISE, ARE DISCLAIMED IN THEIR ENTIRETY AFTER THE EXPIRATION OF THE APPROPRIATE TWO-YEAR OR NINETY DAY WARRANTY PERIOD. RYOBI'S OBLIGATION UNDER THIS WARRANTY, IS STRICTLY AND EXCLUSIVELY LIMITED TO THE REPAIR OR REPLACEMENT OF DEFECTIVE PARTS, AND ROP DOES NOT ASSUME OR AUTHORIZE ANYONE TO ASSUME FOR THEM ANY OTHER OBLIGATION. SOME STATES DO NOT ALLOW LIMITATIONS ON HOW LONG AN IMPLIED WARRANTY LASTS, SO THE ABOVE LIMITATION MAY NOT APPLY TO YOU.

RYOBI ASSUMES NO RESPONSIBILITY FOR INCIDENTAL, CONSEQUENTIAL OR OTHER DAMAGES INCLUDING, BUT NOT LIMITED TO EXPENSE OF RETURNING THE RYOBI PRODUCT TO AN AUTHORIZED SERVICE DEALER AND EXPENSE OF DELIVERING IT BACK TO THE OWNER, MECHANIC'S TRAVEL TIME, TELEPHONE OR TELEGRAM CHARGES, RENTAL OF A LIKE PRODUCT DURING THE TIME WARRANTY SERVICE IS BEING PERFORMED, TRAVEL, LOSS OR DAMAGE TO PERSONAL PROPERTY, LOSS OF REVENUE, LOSS OF USE OF THE PRODUCT, LOSS OF TIME, OR INCONVENIENCE. SOME STATES DO NOT ALLOW THE EXCLUSION OR LIMITATION OF INCIDENTAL OR CONSEQUENTIAL DAMAGES, SO THE ABOVE LIMITATION OR EXCLUSION MAY NOT APPLY TO YOU.

This warranty gives you specific legal rights, and you may also have other rights which vary from state to state.

This warranty applies to all RYOBI Products manufactured by RYOBI and sold in the United States and Canada.

To locate your nearest service dealer dial 1-800-345-8746 in the United States or 1-800-265-6778 in Canada.

RYOBI®

RYOBI OUTDOOR PRODUCTS

550 N. 54th Street
Chandler, AZ 85226 U.S.A.

RYOBI CANADA INC.

275 Industrial Rd
Cambridge, Ontario N1R 6K2 CANADA

SAVE THESE INSTRUCTIONS FOR FUTURE REFERENCE.

FOR QUESTIONS CALL 1-800-345-8746 IN U.S.

OR 1-800-265-6778 IN CANADA

**OPERATOR'S MANUAL PART NO. 181959
PRINTED IN U.S.A.**

**REV. A (7508)
1/98**

Free Manuals Download Website

<http://myh66.com>

<http://usermanuals.us>

<http://www.somanuals.com>

<http://www.4manuals.cc>

<http://www.manual-lib.com>

<http://www.404manual.com>

<http://www.luxmanual.com>

<http://aubethermostatmanual.com>

Golf course search by state

<http://golfingnear.com>

Email search by domain

<http://emailbydomain.com>

Auto manuals search

<http://auto.somanuals.com>

TV manuals search

<http://tv.somanuals.com>