

Register your product and get support at
www.philips.com/welcome

English

SYNTIA

Type HD8833
SUP 037R

OPERATING INSTRUCTIONS



EN

READ THESE OPERATING INSTRUCTIONS CAREFULLY BEFORE USING THE MACHINE.

CE

PHILIPS
 **Saeco**

IMPORTANT SAFEGUARDS

When using electrical appliances, basic safety precautions should always be followed, including the following:

1. Read all instructions.
2. Do not touch hot surfaces. Use handles or knobs.
3. To protect against fire, electric shock and injury to persons do not immerse cord, plugs, or appliance in water or other liquid.
4. Close supervision is necessary when the appliance is used by or near children.
5. Unplug from outlet when not in use and before cleaning. Allow to cool before putting on or taking off parts, and before cleaning the appliance.
6. Do not operate any appliance with a damaged cord or plug or after the appliance malfunctions, or has been damaged in any manner. Return appliance to the nearest authorized service facility for examination, repair or adjustment.
7. The use of accessory attachments not recommended by the appliance manufacturer may result in fire, electric shock or injury to persons.
8. Do not use outdoors.
9. Do not let cord hang over edge of table or counter, or touch hot surfaces.
10. Do not place on or near a hot gas or electric burner, or in a heated oven.
11. Always attach plug to appliance first, then plug cord into wall outlet. To disconnect, turn any control to "off", then remove plug from wall outlet.
12. Do not use appliance for other than intended use.
13. Save these instructions.

SAVE THESE INSTRUCTIONS

CAUTION

This appliance is for household use only. Any servicing, other than cleaning and user maintenance, should be performed by an authorized service center. Do not immerse machine in water. To reduce the risk of fire or electric shock, do not disassemble the machine. There are no parts inside the machine serviceable by the user. Repair should be done by authorized service personnel only.

1. Check voltage to be sure that the voltage indicated on the nameplate corresponds with your voltage.
2. Never use warm or hot water to fill the water tank. Use cold water only.
3. Keep your hands and the cord away from hot parts of the appliance during operation.
4. Never clean with scrubbing powders or harsh cleaners. Simply use a soft cloth dampened with water.
5. For optimal taste of your coffee, use purified or bottled water. Periodic descaling is still recommended every 2-3 months.
6. Do not use caramelized or flavored coffee beans.

INSTRUCTIONS FOR THE POWER SUPPLY CORD

- A. A short power-supply cord (or detachable power-supply cord) is to be provided to reduce risks resulting from becoming entangled in or tripping over a longer cord.
- B. Longer detachable power-supply cords or extension cords are available and may be used if care is exercised in their use.
- C. If a long detachable power-supply cord or extension cord is used,
 1. The marked electrical rating of the detachable power-supply cord or extension cord should be at least as great as the electrical rating of the appliance
 2. If the appliance is of the grounded type, the extension cord should be a grounding-type 3-wire cord, and
 3. The longer cord should be arranged so that it will not drape over the counter top or table top where it can be pulled on by children or tripped over.

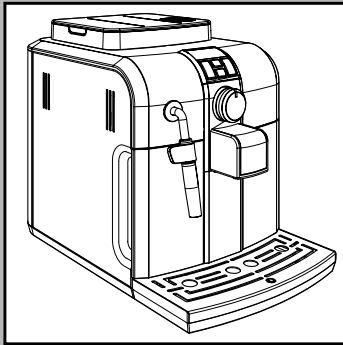

GENERAL INFORMATION

The coffee machine is suitable for preparing espresso coffee using either coffee beans or ground coffee and is equipped with a device to dispense steam and hot water. The structure of the machine has been designed for domestic use only and is not suitable for continuous professional-type operation.

Keep these operating instructions in a safe place and make them available to anyone who may use the coffee machine.

For further information or in case of problems that are not included or not completely explained in these instructions, please contact an authorized service center.



Warning. No liability is held for damage caused by:

- **Incorrect use not in accordance with the intended purposes;**
- **Repairs not carried out by authorized service centers;**
- **Tampering with the power cord;**
- **Tampering with any parts of the machine;**
- **Storage or use of the machine at a temperature outside the operating temperature range (+15°C / +45°C);**
- **The use of non-original spare parts and accessories.**

In these cases, the warranty shall be deemed null and void.

SAFETY REGULATIONS



Never allow water to come into contact with any of the electrical parts of the machine: Danger of short circuit! Steam and hot water may cause scalding! Do not direct the steam/hot water wand towards body parts. Carefully handle the steam/hot water wand by its grip: Danger of scalding!

Intended Use

The coffee machine is intended for domestic use only. Do not make any technical changes or use the machine for unauthorized purposes since this would create serious hazards! The appliance is not to be used by persons (including children) with reduced physical, mental or sensory abilities or with limited experience and/or expertise, unless they are supervised by a person responsible for their safety, or they are instructed by this person on how to properly use the machine.

Power Supply - Power Cord

Only connect the coffee machine to a suitable socket.

The voltage must correspond to that indicated on the machine label located on the inside of service door.

Never use the coffee machine if the power cord is defective or damaged.

If damaged, the power cord must be replaced by the manufacturer or an authorized service center. Do not pass the power cord around corners, over sharp edges or over hot objects and keep it away from oil. Do not use the power cord to carry or pull the coffee machine.

Do not pull out the plug by the power cord or touch it with wet hands. Do not let the power cord hang freely from tables or shelves.

For the Safety of Others

Keep children under control to prevent them from playing with the product. Children are not aware of the risks related to electric household appliances. Do not leave the machine packaging materials within the reach of children.

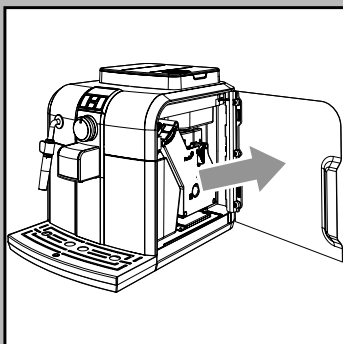

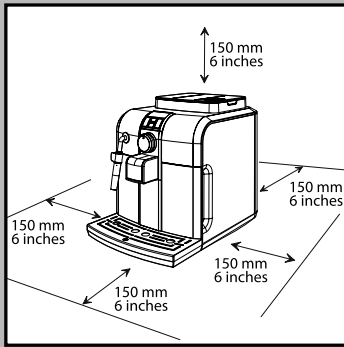

Danger of Burns

Never direct the steam/hot water wand towards yourself or others: **Danger of scalding!** Always use the handles or knobs provided.

Machine Location - Suitable Location for Operation and Maintenance

For best use, it is recommended to:

- Choose a safe, level surface, where there will be no danger of overturning it or being injured.
- Choose a location that is sufficiently well-lit, clean and near an easily reachable socket.
- Provide for a minimum distance from the sides of the machine as shown in the illustration.
- During machine turning on/off, it is recommended to place an empty glass under the dispensing head.

Do not keep the machine at a temperature below 0°C (32°F).

Frost may damage the machine.

Do not use the coffee machine outdoors.

In order to prevent its housing from melting or being damaged, do not place the machine on very hot surfaces and close to open flames.

Storing the Machine - Cleaning

Before cleaning the machine, turn it off by pressing the "STAND-BY" button, and then switch the power button to "0". Remove the plug from the socket.

Wait for the machine to cool down.

Never immerse the machine in water!

It is strictly forbidden to tamper with the internal parts of the machine.

Water left in the tank for several days should not be consumed. Wash the tank and fill it with fresh drinking water.

If the machine will not be used for a long time, dispense water from the steam wand, and carefully clean the Pannarello (if supplied), then turn it off and unplug it.

Store it in a dry place, out of the reach of children.

Keep it protected from dust and dirt.

Servicing / Maintenance

In case of failure, problems or a suspected fault resulting from the falling of the machine, immediately remove the plug from the socket.

Never attempt to operate a faulty machine.

Servicing and repairs may only be carried out by authorized service centers.

All liability for damages resulting from work not carried out by professionals is declined.

Fire Safety Precautions

In case of fire, use carbon dioxide (CO₂) extinguishers. Do not use water or dry powder extinguishers.

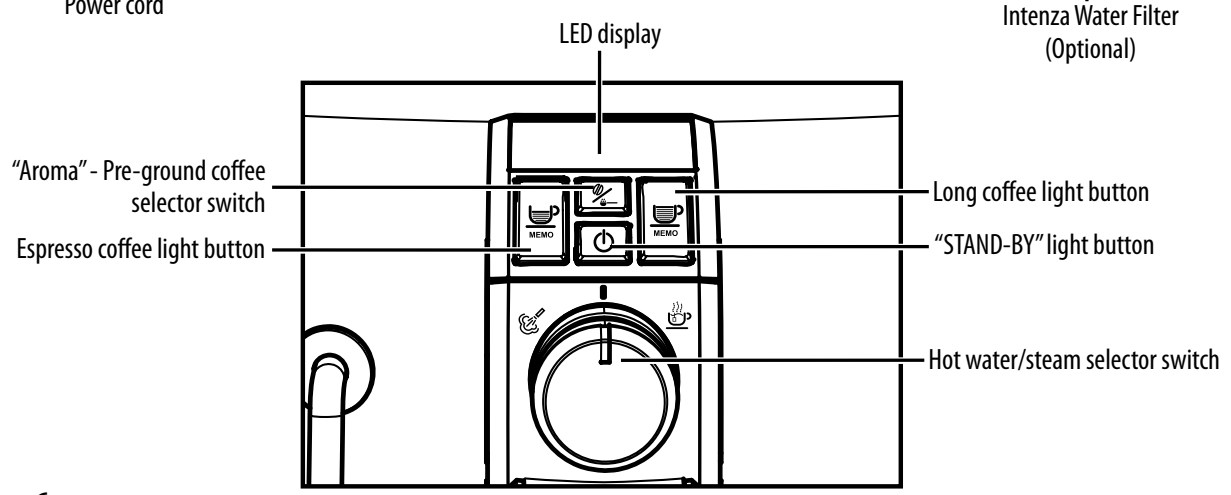
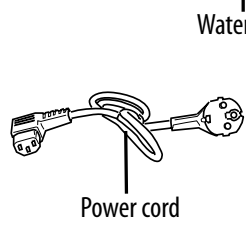
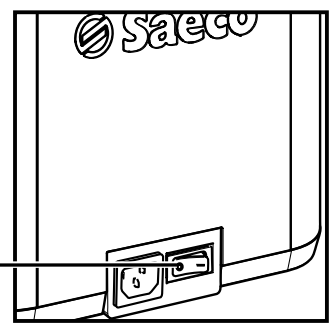
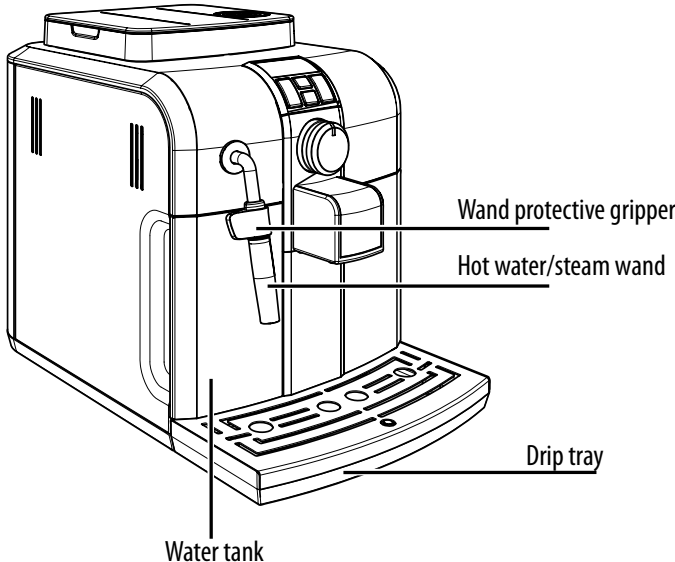
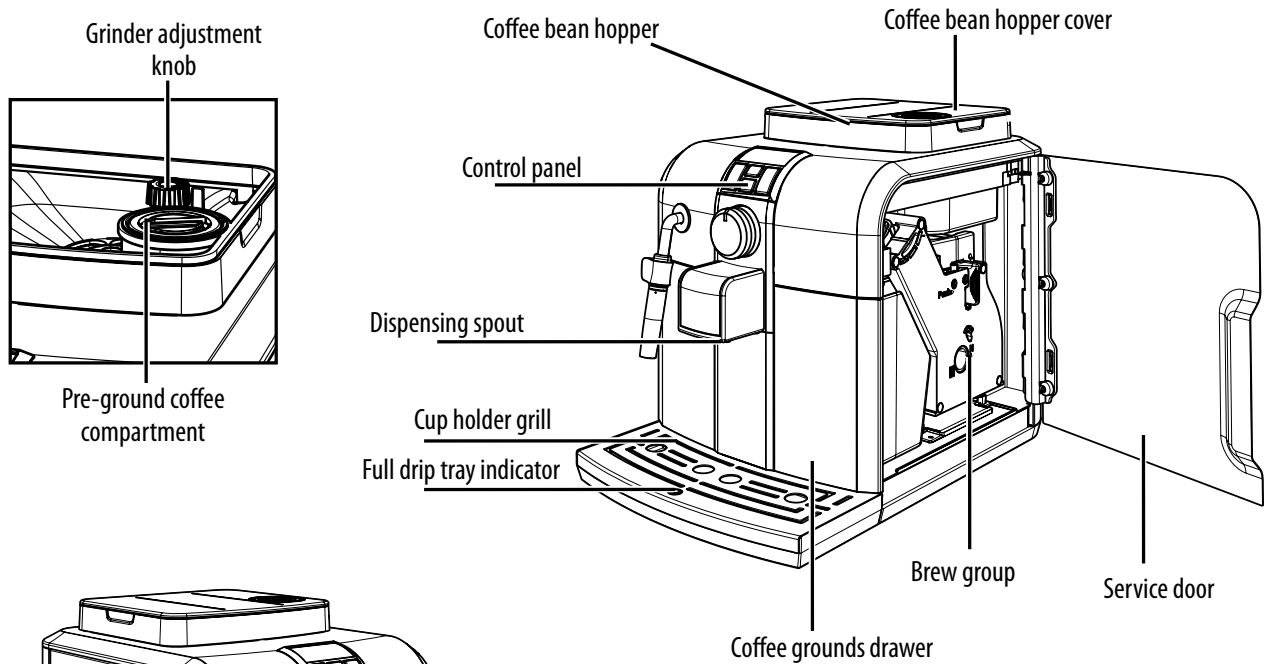

INSTALLATION

For your safety and the safety of others, carefully follow the instructions provided in the "Safety Regulations" section.

Machine Packaging

The original packaging has been designed and constructed to protect the machine during transport. We recommend keeping the packaging material for possible future transport.

Preliminary Operations

- Remove the coffee bean hopper cover and the drip tray with grill from the packaging.
- Remove the coffee machine from the packaging and position it in a place that meets the requirements described in the safety regulations.
- Place the drip tray with grill into its appropriate seat on the machine. Make sure it is fully inserted to its limit stop.
- Insert the coffee bean hopper cover.

i Note: Insert the plug in the machine and in the wall socket only when indicated and check that the power button is switched to "0".

i Important note: Carefully read the explanatory descriptions of all the warnings the machine displays to the user via the lights on the control panel display (see section "Display Warnings").

! NEVER remove the drip tray when the machine is turned on. Wait a couple of minutes after turning on/off, as the machine will be carrying out a rinse/self-cleaning cycle (see section "Rinse/Self-cleaning Cycle").

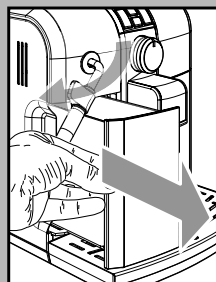
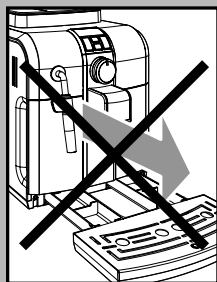
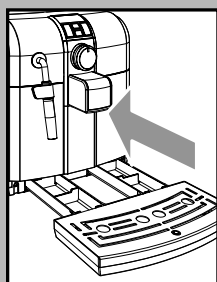

- Remove the water tank from its seat.
- Rinse and fill it with fresh water making sure that it is not filled exceeding the MAX level indicated in the water tank. Put the water tank back in its seat.

! Fill the tank only with fresh, non-sparkling water. Hot water or any other liquid may damage the tank and/or the machine. Do not turn on the machine when the tank is empty: Make sure there is enough water in the tank.

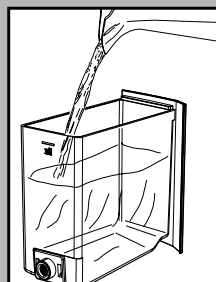

- Remove the coffee bean hopper cover.

i Note: The hopper may be provided with different safety features according to the regulations of the country of use of the machine.

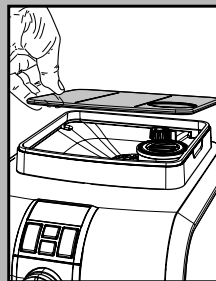

- Slowly pour the coffee beans into the hopper.

! Only coffee beans must be put into the coffee bean hopper. Ground coffee, instant coffee or any other object may damage the machine.

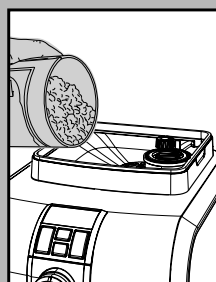

- Replace the coffee bean hopper cover.

- Insert the plug into the socket on the back of the machine.

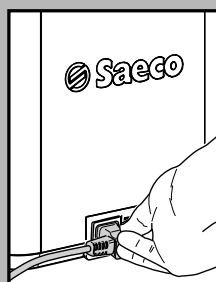

- Insert the plug of the other end of the cable into a wall socket with suitable power voltage.

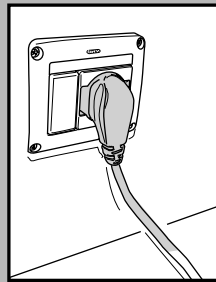

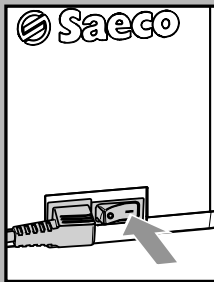

- Switch the power button to "I" to turn the machine on.

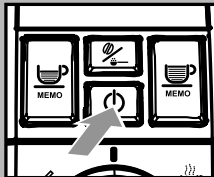

- The "STAND-BY" button blinks.



- Make sure the selector switch is in the "☺" position; if this is not the case, set it to that position.
- To turn the machine on simply press the "STAND-BY" button.

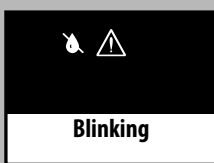

- The blinking icons (shown to the side) warn that the circuit must be primed.

i Note: Before starting the machine for the first time, and after long periods of inactivity, prime the water circuit.

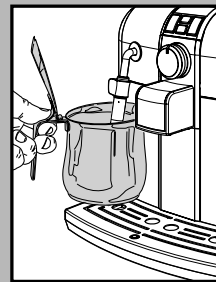

Circuit Priming

- To prime the water circuit, place a container under the steam wand (Pannarello, if supplied).

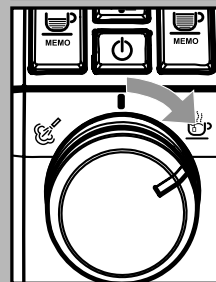

- Turn the selector switch clockwise to set it to the "☺" position. The machine starts the automatic priming of the circuit by letting out a preset quantity of water through the Pannarello.

Once the circuit has been primed, the icon shown in the figure will start blinking on the display.

Turn the selection knob back to its central position "☺".

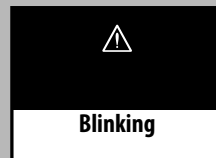

Blinking

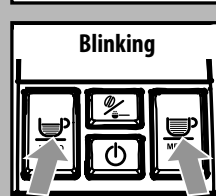

Blinking

- The buttons "☺" and "☺" on the control panel blink slowly together to show that the machine is warming up.

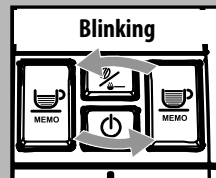

Blinking

i When warm-up is complete, the machine performs a rinse cycle of the internal circuits.

During this phase the buttons "☺" and "☺" blink alternately.

- When the operations described above are completed, the buttons "☺" and "☺" are steady on and the aroma icon on the display turns on.



Steady on

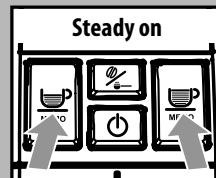

Steady on

i The displayed aroma is the factory setting when the machine is switched on for the first time, or it is the same as the aroma that was selected for the last brewed coffee.

The machine is then ready to brew beverages.

- To brew coffee, dispense hot water or steam, and properly use the machine, carefully follow the instructions provided.

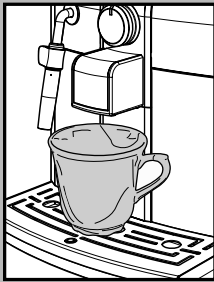

Using the machine for the first time or after a long period of inactivity.

These simple operations will make it possible to always brew excellent coffee.

- 1 Place a large container under the dispensing spout.
- 2 Before starting the procedure, check that the following icon is displayed and that the buttons "MEMO" and "MEMO" on the control panel are steady on.
- 3 Select the pre-ground coffee function by pressing the "☕" button one or more times.

i Do not add the pre-ground coffee to the compartment.

The icon will appear on the display.

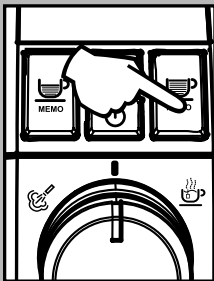
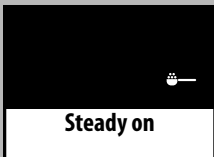
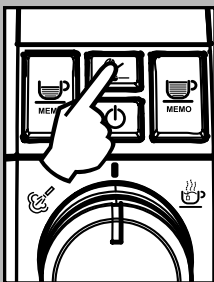

- 4 Press the button to brew a long coffee.
- 5 Wait until brewing is completed and empty the container.
- 6 Repeat the operations from step 1 to step 5 for 3 times; then continue with step 7.

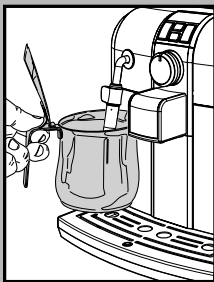

- 7 Place a container under the steam wand (Pannarello, if supplied).

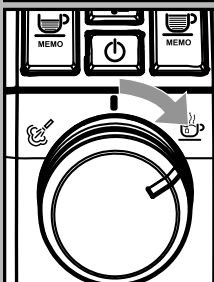

- 8 Turn the selector switch clockwise to set it to the "☕" position.

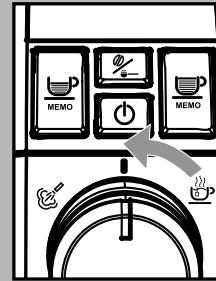
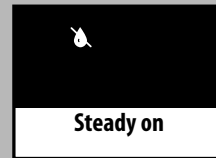

- 9 Dispense water until the no water signal is displayed, then turn the selector switch counter-clockwise to set it to the "☕" position.

- 10 At the end, fill the water tank again. Then the products can be brewed as described in the following sections.

Rinse/Self-cleaning Cycle

This cycle allow rinsing the coffee circuits with fresh water.

The cycle is carried out:

- At machine start (with cold boiler)
- After priming the water circuit (with cold boiler)
- During the Stand-by preparation phase (if a coffee product has been brewed)
- During the phase of activating the stand-by mode after pressing the "STAND-BY" button (if a coffee product has been brewed).

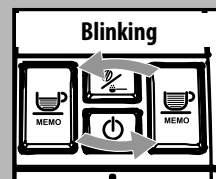

A small amount of water will be dispensed, which will rinse and heat all the machine components; in this phase the buttons "MEMO" and "MEMO" blink alternately.

Wait for the cycle to finish automatically.
You can stop dispensing by pressing either of the two brew buttons.

“INTENZA” water filter (optional)

To improve the quality of the used water, it is advisable to install the water filter.

Remove the water filter from its packaging, immerse it vertically (with the opening positioned upwards) in cold water and delicately press the sides so as to let the air bubbles out.

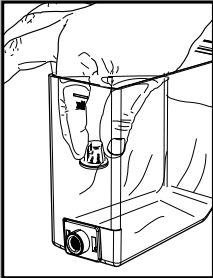

Remove the small white filter from the tank and store it in a dry place sheltered from dust.

Set the Intenza Aroma System as specified on the box.

A = Soft water

B = Medium water (standard)

C = Hard water

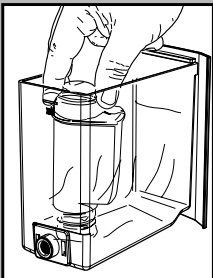

Put the water filter into the empty tank. Press it until its limit stop.

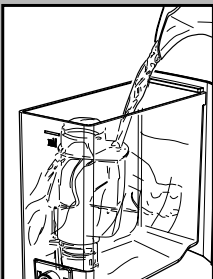

Fill the tank with fresh drinking water and reinsert it into the machine.

Dispense the water in the tank by using the hot water function (see the “Hot water dispensing” section).

Fill the water tank again. The machine is now ready to be used.

i **Note:** If there is no Intenza water filter, insert the small white filter previously removed into the water tank.

ADJUSTMENTS

The machine that you have bought allows for certain adjustments that will permit you to use it to its full potential.

Saeco Adapting System

Coffee is a natural product and its characteristics may change according to its origin, blend and roast. The Saeco coffee machine is equipped with a self-adjusting system that allows the use of all types of coffee beans available on the market (non caramelized).

- The machine automatically adjusts itself in order to optimise the extraction of the coffee, ensuring perfect compression of the tablet to obtain a creamy espresso coffee that will release all the aromas, regardless of the type of coffee used.
- The optimisation process is a learning process that requires the brewing of a certain number of coffees to allow the machine to adjust the compactness of the ground coffee.
- Attention should be given to special blends, which require grinder adjustments in order to optimise the extraction of the coffee (see the “Coffee Grinder Adjustment” section).

Coffee Grinder Adjustment

Warning! The grinder adjustment knob, inside the coffee bean hopper, must be turned only when the grinder is working. Do not pour ground and/or instant coffee into the coffee bean hopper.

Do not insert any material other than coffee beans into the hopper. The grinder contains moving parts that may be dangerous. Therefore, do not insert fingers and/or other objects. The grind setting may only be adjusted using the knob. Turn off the machine and unplug it from the socket before carrying out any type of operation inside the coffee bean hopper. Do not pour coffee beans when the coffee grinder is working.

The machine allows slight adjustments to the coffee grinder to adapt it to the kind of coffee used.

To make any adjustment, press and turn the knob inside the coffee bean hopper.

Press and turn the knob by one notch at a time and brew 2-3 cups of coffee; this is the only way to notice differences in grind.

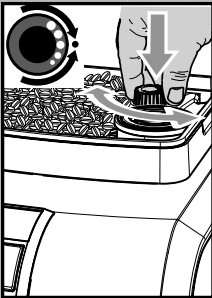

The reference marks inside the coffee bean hopper indicate the grind setting. There are 5 different grind settings to choose from with the following references:

Large Mark - Coarse Grind
Small Mark - Fine Grind.

Adjusting the Coffee Length

The machine allows you to adjust the amount of brewed coffee according to your taste and/or the size of your cups.

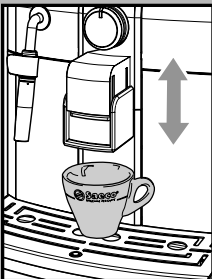

Each time the "MEMO" or "MEMO" buttons are pressed and released, the machine brews a pre-set amount of coffee, as per factory settings. This amount may be reprogrammed to your taste. Each button may be individually programmed for a specific brew setting.

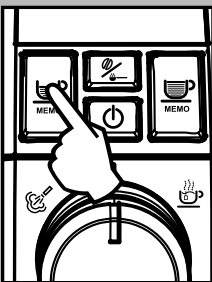

As an example, the following procedure describes the programming of the button "MEMO", which is normally associated with espresso coffee.

- Place a cup under the dispensing spout.
- Hold the "MEMO" button pressed for 5 seconds to enter the programming mode; the button "MEMO" blinks together with the lights of the display shown in the figure and the coffee will start to be brewed. These light signals remain active during the whole cycle.
- Press the "MEMO" button again when the amount of coffee in the cup reaches the desired level.

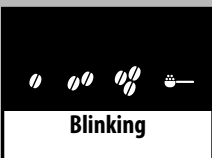

At this point the button "MEMO" is programmed; each time it is pressed and released, the machine will brew the same amount of coffee that was just programmed.

Stand-by

The machine is designed for energy saving. The machine automatically turns off after 60 minutes of inactivity.

The "MEMO" button blinks when the machine is in stand-by mode.

Note: During the turning off phase, the machine performs a rinse cycle, if a coffee product has been brewed.

Warning: When turning the machine on after it has been turned completely off, the machine will be in stand-by mode

To turn the machine on again simply press the STAND-BY button (if the power button is set to "I"). In this case the machine will go through the rinse cycle only if the boiler is cold.

COFFEE BREWING

Note: Should the machine not brew coffee, make sure that the water tank contains water.

Note: Before brewing coffee, check the lights on the display and on the control panel. Check that the water tank and the coffee bean hopper are full.

Note: Leave the selector on the coffee position "I" during the dispensing phase.

Note: Before brewing the coffee, adjust the height of the dispensing spout according to your needs, and select the aroma or the pre-ground coffee.

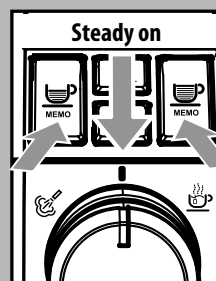

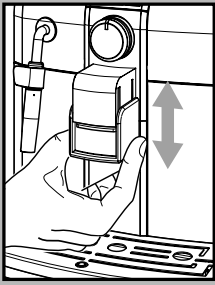

Dispensing Spout Adjustment

Most cups on the market can be used with this coffee machine.

The height of the dispensing spout may be adjusted to better fit the dimensions of the cups that you wish to use.



Manually move the dispensing spout up or down to adjust its height by placing your fingers as shown in the figure.

The recommended positions are:
For use with small cups;

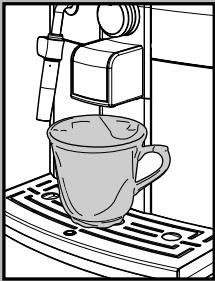

For use with large cups.



- Two cups can be placed under the dispensing spout for brewing two coffees at the same time.

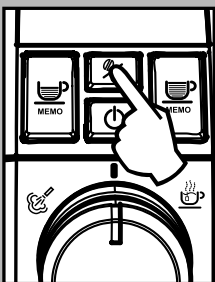

"Aroma" Adjustment

The machine is set-up for an amount of coffee to grind to be adjusted from 7 g to 10.5 g per coffee.

Four choices are possible by pressing and releasing the "☕" button (mild, medium or strong aroma, and ground coffee).

Selection can be made when the beans appear on the display.

Each time the "☕" button is pressed and released, the aroma changes by one degree:

- = Mild aroma
- = Medium aroma
- = Strong aroma

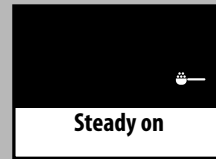
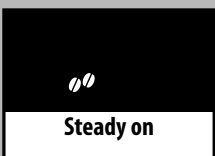

Selection must be made prior to selecting the coffee. The system sets the aroma according to the personal taste of the user.

After selecting "Strong aroma", the function for brewing coffee with pre-ground coffee is displayed.

This selection is displayed by the icon on the side.

Refer to the relevant section to use this function.

Using Coffee Beans

- To brew coffee, press and release: the "☕" button to select the desired aroma.

the "☕" button for an espresso coffee;

the "☕" button for a long coffee.

- The brewing cycle then starts:

To brew 1 cup of coffee, press the "☕" or "☕" button once. The pressed button will be steady on.

To brew 2 cups of coffee, press the "☕" or "☕" button twice consecutively. The pressed button will blink quickly.

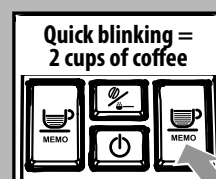
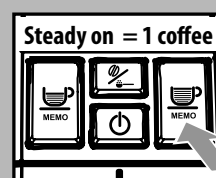
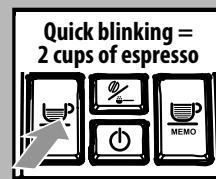
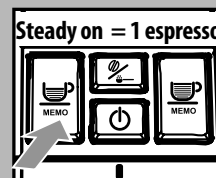
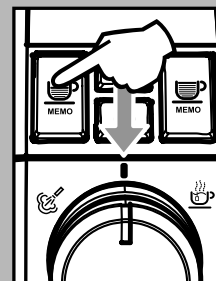

i To brew 2 coffees, the machine automatically grinds and doses the correct amount of coffee. Brewing two coffees requires two grinding cycles and two brewing cycles, which the machine carries out automatically.

- After the prebrewing cycle, coffee begins to come out of the dispensing spout.

- Coffee brewing stops automatically when the pre-programmed level is reached; however, it is possible to interrupt coffee brewing by pressing the button initially pressed.

i The machine is adjusted to brew a true Italian espresso coffee. This feature may slightly lengthen the brewing time, allowing the intense flavour of the coffee to develop fully.

Using Pre-ground Coffee

i This function allows using pre-ground and decaffeinated coffee.

Pre-ground coffee must be poured into the appropriate compartment positioned next to the coffee bean hopper. Only use ground coffee for espresso machines and never coffee beans or instant coffee.

i Note:

- If no pre-ground coffee is poured into the compartment, only water will be dispensed;
- If the dose is excessive and 2 or more measuring scoops of coffee are used, the machine will not brew the product. Also in this case, the machine will run an empty cycle and discharge any ground coffee into the coffee grounds drawer.

To brew coffee:

- Press and release the “☕” button until the pre-ground coffee function icon is displayed.
- Lift the pre-ground coffee compartment cover.
- Add **1 only 1 scoop** of pre-ground coffee to the compartment. Use the measuring scoop supplied with the machine to perform this operation. Then, close the cover.

! **Warning: Only add pre-ground coffee to the compartment. Other substances and objects may cause severe damage to the machine. This damage will not be covered by warranty.**

Press and release:

the “☕” button for an espresso coffee;

the “☕” button for a long coffee.

- The brewing cycle then starts. After the prebrewing cycle, coffee begins to come out of the dispensing spout.

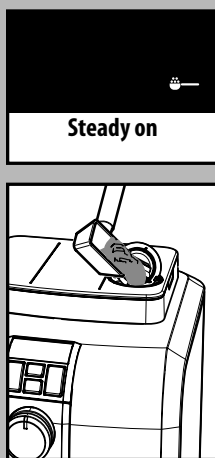

- Coffee brewing stops automatically when the pre-programmed level is reached; however, it is possible to interrupt coffee brewing by pressing the button initially pressed.

After dispensing the product, the coffee beans configuration of the machine is restored.

i Repeat the operations described above to brew other coffees.

DISPENSING HOT WATER

! **Warning: At the beginning, short spurts of hot water may come out. Danger of scalding. The hot water wand may reach high temperatures. Never touch it with bare hands.**

- Before dispensing hot water check that all the lights on the display and on the control panel are on.

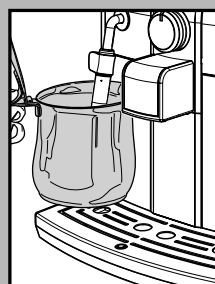
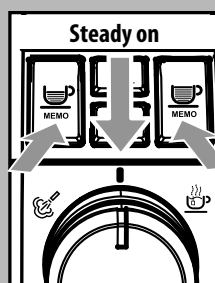
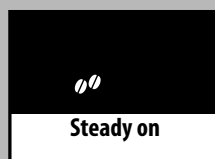

When the machine is ready, proceed as follows:

- Place a container under the steam wand (Pannarello, if supplied).

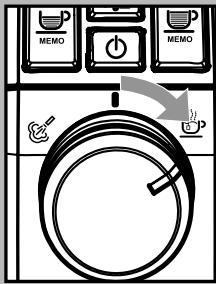

- Turn the selector switch clockwise to set it to the “☕” position.

i Note: The lights that indicate the aroma are off when dispensing hot water.

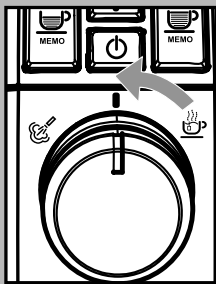

- Fill the cup with hot water to the desired level; to stop hot water dispensing, turn selector switch counter-clockwise back to the “☑” position. The machine returns to the normal operating mode.

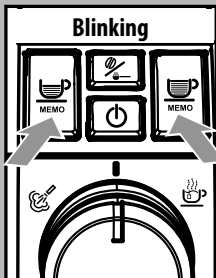

i Occasionally, after turning the selector switch, hot water may not be dispensed and the buttons will start blinking. Simply wait until the end of the warm-up phase so that hot water can be dispensed from the Pannarello.

STEAM DISPENSING / PREPARING A CAPPUCINO

Steam may be used to froth milk for a cappuccino, as well as to reheat other beverages.

! **Danger of scalding!** Brewing may be preceded by small jets of hot water. The steam wand may reach high temperatures. Never touch it with bare hands.

i Important note: immediately after using the steam to froth the milk, clean the steam wand (or Pannarello when provided). When the machine is ready, brew a small amount of hot water in a glass and clean the steam wand (or Pannarello when provided) externally. In this way, all parts will be perfectly clean



and free of any milk residue.

i To prepare your cappuccino, we recommend discharging the water in the steam wand.

- To discharge the water in the steam wand, place a container under the steam wand (Pannarello, if supplied).

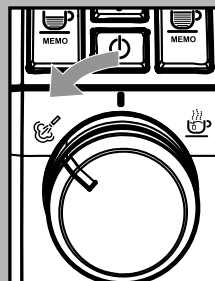

- When the machine is ready to brew coffee, turn selector switch counter-clockwise to set it onto the “☕” position. Residual water may come out of the steam wand (Pannarello, if supplied).

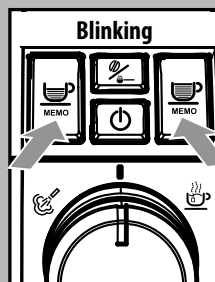

- The “☕” and “☕” lights blink during the preheating time required by the machine.

i Note: The lights that indicate the aroma are off when dispensing steam.

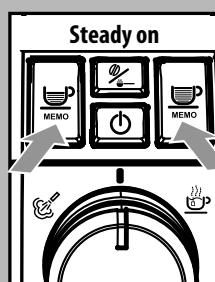

- Steam dispensing will begin when the buttons “☕” and “☕” are displayed steady on; soon after, only steam will begin to come out.

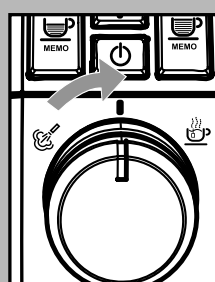

- Turn the selector switch clockwise and set it back to the “☕” position to stop dispensing steam.

- Fill 1/3 of the container you wish to use to prepare the cappuccino with cold milk.

i To ensure better results when preparing a cappuccino, use cold milk straight from the fridge.

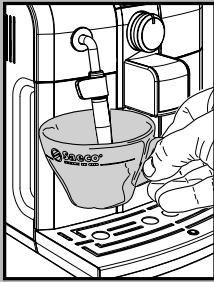

- Immerse the steam wand (Pannarello, if supplied) in the milk to be heated.

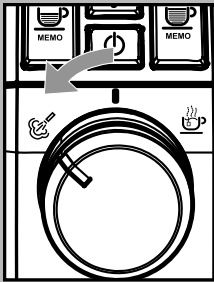

- Turn the selector switch counter-clockwise to set it to the “☕” position. Rotate the container and move it gently up and down to obtain uniform foam.

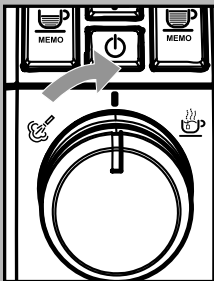

- After dispensing steam for the desired time, turn the selector switch clockwise and set it back to the “☕” position to stop dispensing steam.
- The same procedure can be used to heat other beverages.

After using the steam wand (Pannarello, if supplied), wash it as described in the “Cleaning and Maintenance” section.

i After using steam to prepare a beverage, it is possible to brew coffee or to dispense steam straight after.

i If the selector switch is left on the central position “0”, the machine, in order to save energy, automatically reaches the temperature needed to dispense coffee.

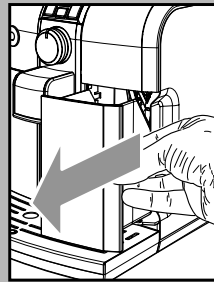

CLEANING AND MAINTENANCE

General Cleaning

- Empty and clean the coffee grounds drawer daily, with the machine turned on.

i Note: We recommend emptying the container if the machine is not going to be used for some days.

- Maintenance and cleaning operations can only be carried out when the machine is cold and disconnected from the electric network.
- Do not immerse the machine in water.
- Do not wash any of its parts in the dishwasher.
- Do not use sharp objects or harsh chemical products (solvents) for cleaning.
- Use a soft, dampened cloth to clean the machine.
- Do not dry the machine and/or its components using a microwave and/or standard oven.

i After preparing milk beverages, dispense hot water from the steam wand (Pannarello, if supplied) to obtain a thorough cleaning.

- Every day, after heating the milk, remove the external part of the Pannarello (if supplied) and wash it with fresh drinking water.
- Clean the steam wand weekly. In order to do this, perform the following operations:
 - Remove the external part of the Pannarello (for standard cleaning);
 - Remove the upper part of the Pannarello from the steam wand;
 - Wash the upper part of the Pannarello with fresh drinking water;
 - Wash the steam wand with a wet cloth and remove any milk residue;
 - Replace the upper part in the steam wand (make sure it is completely inserted).

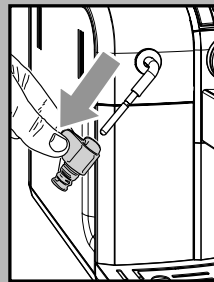
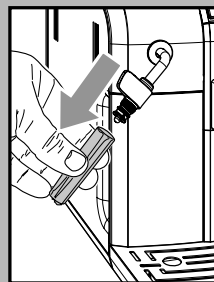

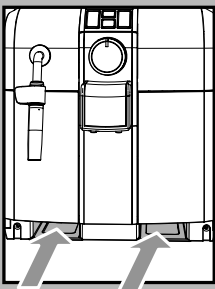
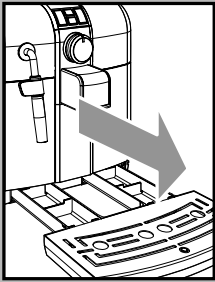
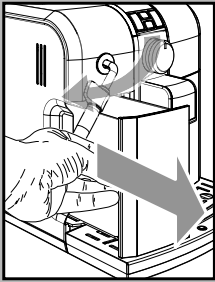

- Reassemble the external part of the Pannarello.
- We recommend cleaning the water tank daily. For an easier removal of the water tank, move the steam wand / Pannarello upwards:
 - Remove the small white filter in the water tank and wash it under running drinking water.
 - Reposition the small white filter in its housing by gently pressing and turning it at the same time.
 - Fill the water tank with fresh drinking water.
- Empty and clean the drip tray daily. Perform this operation also when the float is raised.
- Also clean the seat of the tray every week through the openings on the bottom of the machine.

Brew Group

- The brew group should be cleaned every time the coffee bean hopper is filled or at least once a week.
- Turn off the machine by pressing the ON/OFF button and remove the plug from the socket.
- Remove the coffee grounds drawer. Open the service door.
- To remove the brew group, pull it by the handle and press the «PUSH» button. The brew group must be washed only with lukewarm water with no detergent/soap.

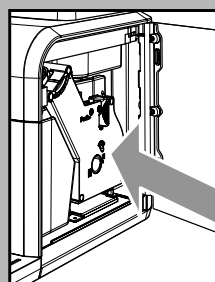
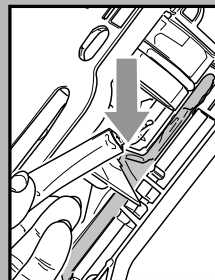
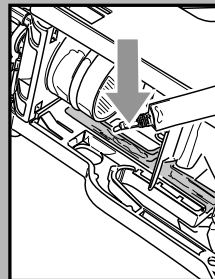
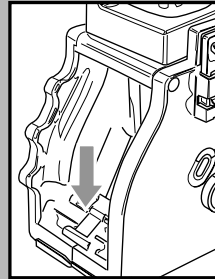
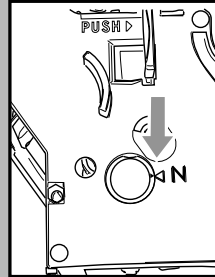
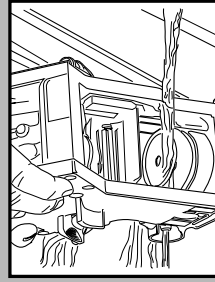

- Wash the brew group with lukewarm water and carefully clean the upper filter.
- Thoroughly wash and dry all the parts of the brew group.
- Thoroughly clean the inside of the machine.
- Make sure that the two reference signs match up.
- Make sure that the lever is in contact with the brew group. Press the "PUSH" button to make sure that the brew group is in the correct position.

i Lubricate the brew group after approximately 500 brewing cycles. The grease to lubricate the brew group may be purchased at authorised service centres.

- Lubricate the brew group guides using the supplied grease only.
- Apply the grease evenly on both side guides.
- Insert the brew group in its seat until it locks into place WITHOUT pressing the "PUSH" button.
- Insert the coffee grounds drawer. Close the service door.

DESCALING

Limescale normally builds up with the use of the appliance.

The machine must be descaled when the icon appears on the display.

i **Important note: It is recommended to refer to the next section, "Remarks on Descaling", for some tips about keeping the machine in perfect working order.**

i **Do not turn the machine off or put it in stand-by mode during the descaling process.**

i **Only use the Saeco descaling solution. Its formula has been designed to ensure better machine performance and operation for its whole operating life. If correctly used, it also avoids alterations in the brewed product.**

! **Warning! Never drink the descaling solution or any products dispensed until the cycle has been carried out to the end. Never use vinegar as a descaling solution.**

Before descaling, remove the Pannarello (if supplied) from the steam wand as described in the "Cleaning and Maintenance" section.

• Turn the machine on by pressing the "STAND-BY" button. **Wait for the machine to finish its rinse cycle and warm up.**

! **Warning! Remove the "Intenza" filter (if installed) before adding the descaling solution.**

• Pour the entire content of the Saeco concentrated descaling solution into the water tank, and then fill the tank with fresh drinking water up to the MAX level. Place the tank back in the machine.

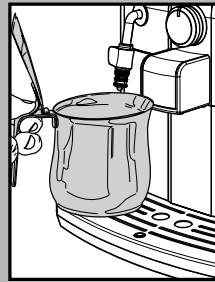
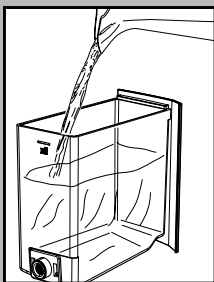
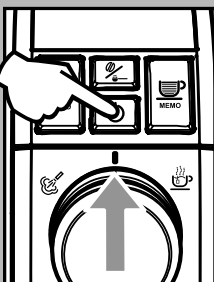
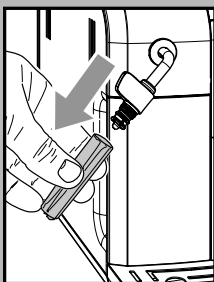
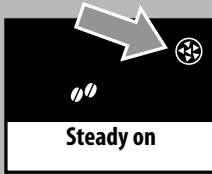

1 Place a container below the steam wand.

i **Use a container of at least 1 litre capacity. If you do not have a container of this capacity, once it is filled close the knob, empty the container and then place it again under the wand and repeat the procedure.**

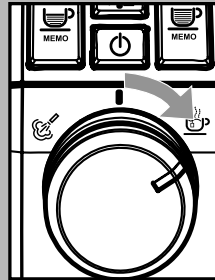

2 Only after adding the descaling solution in the tank, turn the selector switch clockwise to position "☕", and then dispense 2-3 cups of water (approx. 150 ml).

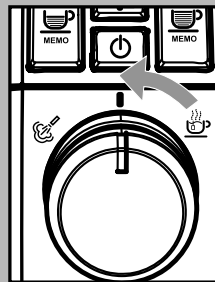

3 Stop dispensing by turning the selector switch back to its central position "0".

4 Allow the descaling solution to work for 10 minutes.

5 Repeat steps 2 and 3 at intervals of 3 minutes, until there is no descaling solution left in the water tank.

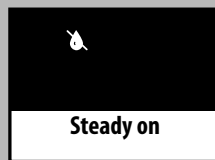

6 When the icon is displayed, rinse the water tank thoroughly and refill it with fresh drinking water.

7 Empty the container used to collect the liquid dispensed by the machine and place it under the steam wand.

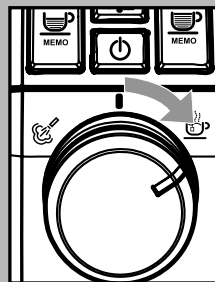
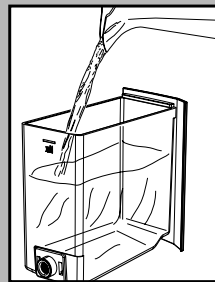

8 Turn the selector switch clockwise to set it to the "☕" position. The machine rinse cycle starts.

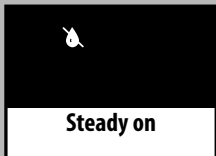

- 9 When the water in the tank is finished, the icon on the side is displayed to indicate that the selector switch must be brought back to the "0" position.

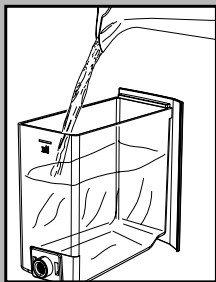
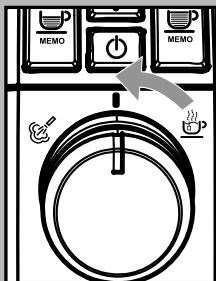

- 10 Rinse the water tank thoroughly and refill it with fresh drinking water.
11 Empty the container used to collect the liquid dispensed by the machine.

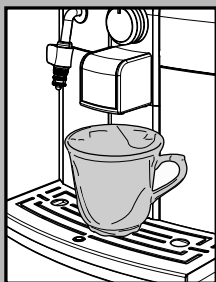

- 12 Place a large container under the dispensing spout.

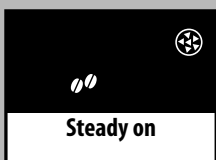

- 13 Before starting the procedure, check that the following icons are displayed.

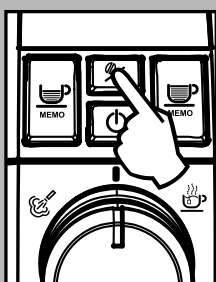

- 14 Select the pre-ground coffee function by pressing the "☕" button one or more times.

i Do not add the pre-ground coffee to the compartment.

The icon will appear on the display.



- 15 Press the button to brew a long coffee.

16 Wait until brewing is completed and empty the container with water.

- 17 Repeat the operations from step 12 to step 16 for 3 times; then continue with step 18.

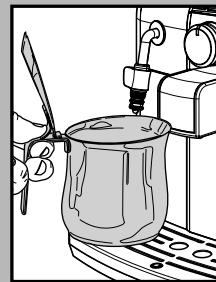

- 18 Place a container under the steam wand (Pannarello, if supplied).

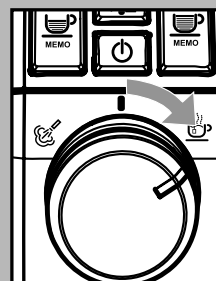

- 19 Turn the selector switch clockwise to set it to the "☕" position.

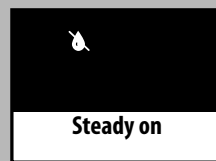

- 20 Dispense water until the no water signal is displayed, then turn the selector switch counter-clockwise to set it to the "0" position.

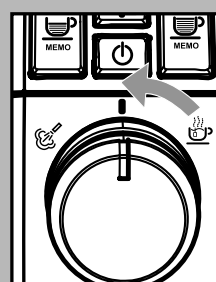

- 21 At the end, fill the water tank again.

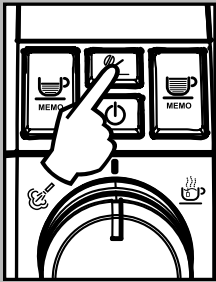

22 Hold the "MEMO" button pressed for 6 seconds to reset the machine and cancel the descaling alarm signal. The light "MEMO" turns off.

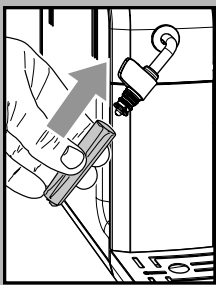

Reassemble the external part of the Panarello.

The descaling cycle is complete. Then, the products can be brewed.

i If the machine is switched off during the descaling cycle, next time the machine is switched on the cycle must be repeated from the beginning.

i The descaling solution must be disposed of according to the manufacturer's instructions and/or regulations in force in the country of use.

i After completing the descaling cycle, wash the brew group as described in the "Brew Group" section in the "Cleaning and maintenance" section.

Remarks on Descaling

The previous section explains the correct operations to perform to descale the machine.

The machine you have purchased is equipped with advanced software to check the quantity of used water in order to provide reliable information about the right time to carry out descaling operations.

This software has been programmed for standard water hardness.

In case of especially hard water (high calcium content), descaling cycles might have to be carried out more frequently, even if the machine does not display warning signals.

Even if the machine is not used often (e.g. 1 coffee per day), it is recommended to perform descaling cycles more frequently.

In these specific cases, it is recommended to perform descaling cycles every 1-2 months, even if the machine does not signal it.

CONTROL PANEL DISPLAY

Ready Signals

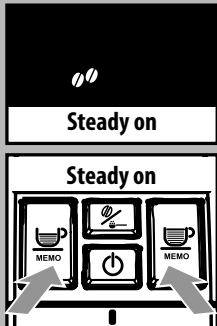

- The machine is ready for brewing coffee from bean and hot water dispensing.

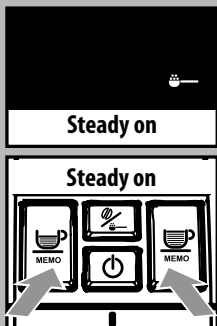

- The machine is ready for pre-ground coffee brewing.

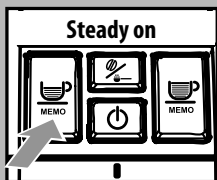

- The machine is brewing 1 cup of espresso coffee.

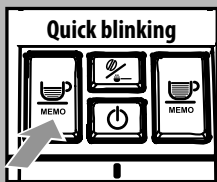

- The machine is brewing 2 cups of espresso coffee.

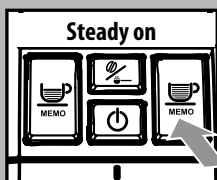

- The machine is brewing 1 cup of long coffee.

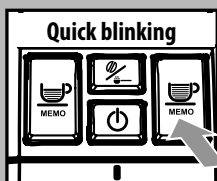

- The machine is brewing 2 cups of long coffee.

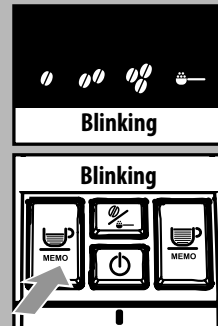

- The machine is programming the amount of coffee to be brewed for each espresso coffee.



- The machine is programming the amount of coffee to be brewed for each long coffee.

Warning Signals

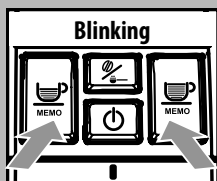

- The machine is warming up to brew coffee and dispense hot water or steam.

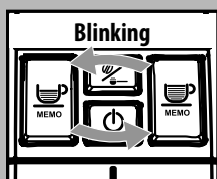

- The machine is performing the rinse cycle. Wait until the machine stops the operation.



- The machine needs a descaling cycle.



- The machine needs water circuit priming.



- Brew group overstressed
The coffee cycle will be interrupted. Perform a coffee cycle again.

Alarm Signals



- Return the hot water / steam knob to its correct position.
- Insert the brew group in the machine.
- Close the service door.



- Empty the coffee grounds drawer.



- Insert the coffee grounds drawer.



- No coffee beans in the coffee bean hopper. After refilling the hopper, the cycle can be restarted.



- Fill the water tank.



- OUT OF SERVICE
Turn off the machine using the power button on its back and turn it on again. If the error persists, contact the service centre.

TROUBLESHOOTING

Machine Actions	Causes	Solutions
The machine does not turn on.	The machine is not connected to the power source.	Connect the machine to the power source.
The coffee is not hot enough.	The cups are cold.	Warm the cups with hot water.
No hot water or steam is dispensed.	The hole of the steam wand is clogged.	Clean the hole of the steam wand using a pin. Make sure that the machine is turned off and has cooled before performing this operation.
	Pannarello is dirty (if supplied).	Clean the Pannarello.
The coffee has little crema. (see note)	The coffee blend is unsuitable, the coffee is not freshly roasted or the grind is too coarse.	Change coffee blend or adjust the grind as explained in the "Coffee Grinder Adjustment" section.
The machine takes a long time to warm up or the amount of water dispensed from the wand is too little.	The machine circuit is obstructed by limescale build-up.	Descale the machine.
The brew group does not come out.	The brew group is out of place.	Turn the machine on. Close the service door and insert the coffee grounds drawer. The brew group automatically returns to the initial position.
	Dregdrawer is inserted.	Remove the dregdrawer first, then the brew group.
The machine grinds the coffee beans but no coffee comes out. (see note)	Water tank is empty.	Fill the water tank and prime the circuit (section "Using the Machine for the First Time").
	Brew group is dirty.	Clean the brew group (section "Brew Group").
	Circuit is not primed.	Prime the circuit (section "Using the Machine for the First Time").
	Rare event that occurs when the machine is automatically adjusting the dose.	Brew a few coffees as described in section "Saeco Adapting System".
	The dispensing head is dirty.	Clean the dispensing head.
The coffee is too weak. (see note)	Rare event that occurs when the machine is automatically adjusting the dose.	Brew a few coffees as described in section "Saeco Adapting System".
Coffee is brewed slowly. (see note)	The coffee grind is too fine.	Change coffee blend or adjust the grind as explained in the "Coffee Grinder Adjustment" section.
	The circuit is not primed.	Prime the circuit (section "Using the Machine for the First Time").
	The brew group is dirty.	Clean the brew group (section "Brew Group").
Coffee leaks out of the dispensing head.	The dispensing head is clogged.	Clean the dispensing head and its holes.

Note: These problems can be considered normal if the coffee blend has been changed or if the machine has just been installed. In this case wait until the machine performs a self-adjusting operation as described in section "Saeco Adapting System".

Please contact Saeco Customer Service or an authorized service center for any problems not covered in the above table or when the suggested solutions do not solve the problem.

TECHNICAL SPECIFICATIONS

The manufacturer reserves the right to make changes to the technical specifications of the product.

Nominal Voltage - Power Rating - Power Supply	See label on the inside of the service door
Housing material	Thermoplastic material/Metal
Size (w x h x d)	10" x 12.5" x 16" (256 x 315 x 415 mm)
Weight	20 lbs. (9 kg)
Power Cord Length	47" (1.2m)
Control Panel	Front side
Pannarello (only available for certain models)	Special for cappuccinos
Water tank	1.2 litres – Removable type
Coffee Bean Hopper Capacity	9.2 oz. (260 g)
Dregdrawer Capacity	8
Pump pressure	15 bar
Boiler	Stainless steel type
Safety Mechanisms	Thermal fuse

English

MACHINE DISPOSAL

- The packing materials can be recycled.
- Appliance: Unplug the appliance and cut the power cord.
- Deliver the appliance and power cord to a service center or public waste disposal facility.

This product complies with eu directive 2002/96/ec.



The symbol  on the product or on its packaging indicates that this product may not be treated as household waste. Instead it shall be handed over to the applicable collection point for the recycling of electrical and electronic equipment.

By ensuring this product is disposed of correctly, you will help prevent potential negative consequences for the environment and human health, which could otherwise be caused by inappropriate waste handling of this product. For more detailed information about recycling of this product, please contact your local city office, your household waste disposal service or the shop where you purchased the product.

EC DECLARATION OF CONFORMITY
YEAR 09
EC 2006/95, EC 2004/108.

SAECO INTERNATIONAL GROUP S.P.A

Via Torretta, 240 - 40041 Gaggio Montano (Bo) - Italy

declare under our responsibility that the product :

AUTOMATIC COFFEE MAKER

SUP 037R

to which this declaration relates is in conformity with the following standards or other normative documents :

- Safety of household and electrical appliances - General requirements EN 60335-1(2002) + A1(2004) + A2(2006) + A11(2004) + A12(2006)+ A13(2008)
- Safety of household and electrical appliances - Part 2-15 Particular requirements for appliances for heating liquids EN 60335-2-15(2002) + A1(2005) + A2 (2008).
- Household and similar electrical appliances - Electromagnetic fields - methods for evaluation and measurement - EN 62233 (2008).
- Household and similar electrical appliances - safety - Part 2-14 Particular requirements for kitchen machines - EN 60335-2-14 (2006) + A1 (2008).
- Electromagnetic compatibility (EMC) - Requirements for household appliances , electric tools and similar apparatus - Part 1 - Emission - EN 55014-1 (2006).
- Electromagnetic compatibility (EMC) - Part. 3^ Limits - Section 2 : Limits for harmonic current emissions (equipment input current ≤ 16A for phase) EN 61000-3-2 (2006)
- Electromagnetic compatibility (EMC) - Part 3^ : Limits - Section 3 : Limitation of voltage changes , voltage fluctuations and flicker in public low - voltage supply systems , for equipment with rated current ≤ 16 A for phase and not subject to conditional connection EN 61000-3-3 (1995)+ corr.(1997) +A1 (2001) + A2 (2005).
- Electromagnetic compatibility - Requirements for household appliances , electric tools and similar apparatus - Part 2. Immunity - Product family standard EN 55014-2 (1997) + A1 (2001).

following the provisions of the Directives: EC 2006/95 , EC 2004/108.

Gaggio Montano
li, 28/04/2009

R & D Manager
Mr. Andrea Castellani

Type HD8833 - Cod.15002520 Rev.00 del 15-03-10

EN

The manufacturer reserves the right to change the features of the product without prior notice.



www.philips.com/saeco

Free Manuals Download Website

<http://myh66.com>

<http://usermanuals.us>

<http://www.somanuals.com>

<http://www.4manuals.cc>

<http://www.manual-lib.com>

<http://www.404manual.com>

<http://www.luxmanual.com>

<http://aubethermostatmanual.com>

Golf course search by state

<http://golfingnear.com>

Email search by domain

<http://emailbydomain.com>

Auto manuals search

<http://auto.somanuals.com>

TV manuals search

<http://tv.somanuals.com>