

Minuto

INSTRUCTIONS FOR USE

Type HD8761 - HD8764

Read carefully before using the machine.



EN

02

CE

Register your product and get support at

www.philips.com/welcome

IMPORTANT SAFEGUARDS

When using electrical appliances, basic safety precautions should always be followed, including the following:

1. Read all instructions.
2. Do not touch hot surfaces. Use handles or knobs.
3. To protect against fire, electric shock and injury to persons do not immerse cord, plugs, or appliance in water or other liquid.
4. Close supervision is necessary when the appliance is used by or near children.
5. Unplug from outlet when not in use and before cleaning. Allow to cool before putting on or taking off parts, and before cleaning the appliance.
6. Do not operate any appliance with a damaged cord or plug or after the appliance malfunctions, or has been damaged in any manner. Return appliance to the nearest authorized service facility for examination, repair or adjustment.
7. The use of accessory attachments not recommended by the appliance manufacturer may result in fire, electric shock or injury to persons.
8. Do not use outdoors.
9. Do not let cord hang over edge of table or counter, or touch hot surfaces.
10. Do not place on or near a hot gas or electric burner, or in a heated oven.
11. Always attach plug to appliance first, then plug cord into wall outlet. To disconnect, turn any control to "off", then remove plug from wall outlet.
12. Do not use appliance for other than intended use.
13. Save these instructions.

SAVE THESE INSTRUCTIONS

CAUTION

This appliance is for household use only. Any servicing, other than cleaning and user maintenance, should be performed by an authorized service center. Do not immerse machine in water. To reduce the risk of fire or electric shock, do not disassemble the machine. There are no parts inside the machine serviceable by the user. Repair should be done by authorized service personnel only.

1. Check voltage to be sure that the voltage indicated on the nameplate corresponds with your voltage.
2. Never use warm or hot water to fill the water tank. Use cold water only.
3. Keep your hands and the cord away from hot parts of the appliance during operation.
4. Never clean with scrubbing powders or harsh cleaners. Simply use a soft cloth dampened with water.
5. For optimal taste of your coffee, use purified or bottled water. Periodic descaling is still recommended every 2-3 months.
6. Do not use caramelized or flavored coffee beans.

INSTRUCTIONS FOR THE POWER SUPPLY CORD

- A. A short power-supply cord (or detachable power-supply cord) is to be provided to reduce risks resulting from becoming entangled in or tripping over a longer cord.
- B. Longer detachable power-supply cords or extension cords are available and may used if care is exercised in their use.
- C. If a long detachable power-supply cord or extension cord is used,
 1. The marked electrical rating of the detachable power-supply cord or extension cord should be at least as great as the electrical rating of the appliance
 2. If the appliance is of the grounded type, the extension cord should be a grounding-type 3-wire cord, and
 3. The longer cord should be arranged so that it will not drape over the counter top or table top where it can be pulled on by children or tripped over.

Congratulations on your purchase of a Saeco Minuto Classic Milk Frother full automatic espresso machine!
*To fully benefit from the support that Saeco offers, please register your product at **www.philips.com/welcome**.*
This user manual applies to HD8761 and HD8764.
The machine is suitable for preparing espresso coffees using whole coffee beans. It can also dispense steam and hot water. In this user manual you will find all the information you need to install, use, clean and descale your machine.

CONTENTS

IMPORTANT	4
Safety instructions	4
Warning	4
Caution	6
Compliance with standards	7
INSTALLATION	8
Product overview	8
General description	9
PREPARING FOR USE	10
Machine packaging.....	10
Machine installation.....	10
USING THE MACHINE FOR THE FIRST TIME	12
Circuit priming	12
Automatic rinse/self- cleaning cycle	13
Manual rinse cycle.....	14
Measuring and programming water hardness	16
“INTENZA+” water filter installation	17
Replacing the “INTENZA+” water filter.....	19
ADJUSTMENTS	20
Saeco Adapting System.....	20
Adjusting the ceramic coffee grinder.....	20
Adjusting the aroma (coffee strength)	21
Adjusting the dispensing spout.....	22
Adjusting the coffee length	23
ESPRESSO AND COFFEE BREWING	24
Espresso and Coffee brewing using coffee beans.....	24
Espresso and Coffee brewing using pre-ground coffee	25
STEAM DISPENSING /CAPPUCCINO BREWING	26
HOT WATER DISPENSING	27
CLEANING AND MAINTENANCE	28
Daily cleaning of the machine	28
Daily cleaning of the water tank.....	29
Daily cleaning of the Classic Milk Frother	30
Weekly cleaning of the machine	30
Weekly cleaning of the Classic Milk Frother.....	30
Weekly cleaning of the brew group.....	31
Monthly lubrication of the brew group	34
Monthly cleaning of the brew group with “Coffee Oil Remover”	35
Monthly cleaning of the coffee bean hopper	37
DESCALING	38
MEANING OF THE DISPLAY SYMBOLS	42
TROUBLESHOOTING	45
ENERGY SAVING	47
Stand-by	47
Disposal	47
TECHNICAL SPECIFICATION	48
GUARANTEE AND SERVICE	48
Guarantee	48
Service	48
ORDERING MAINTENANCE PRODUCTS	49

IMPORTANT

Safety instructions

This machine is equipped with safety features. Nevertheless read the safety instructions carefully and only use the machine as described in these instructions to avoid accidental injury or damage.

Keep this user manual for future reference.



The term **WARNING** and this sign warn against possible severe injuries, danger to life and/or damage to the machine.



The term **CAUTION** and this sign warn against slight injuries and/or damage to the machine.

Warning

- Connect the machine to a wall socket which is properly wired. Its main voltage should comply with the technical data of the machine.
- Do not let the mains cord hang over the edge of a table or counter, or touch hot surfaces.
- Never immerse the machine, mains plug or mains cord in water (danger of electrical shock).
- Never direct the hot water jet towards body parts (danger of burning).

- Do not touch hot surfaces. Use handles and knobs.
- Remove the mains plug from the wall socket:
 - If a malfunction occurs.
 - If the machine will not be used for a long time.
 - Before cleaning the machine.

Pull on the plug, not on the power cord. Do not touch the mains plug with wet hands.

- Do not use the machine if the mains plug, the mains cord or the machine itself is damaged.
- Do not make any modifications to the machine or its power cord. Only have repairs carried out by a service centre authorized by Philips to avoid a hazard.
- This machine is not intended for use by persons (including children) with reduced physical, sensory or mental capabilities, or lack of experience and knowledge, unless they have been given supervision or instruction concerning use of the machine by a person responsible for their safety.
- Children should be supervised to ensure that they do not play with the machine.
- Never insert fingers or other objects into the coffee grinder.

Caution

- The machine is for household use only. It is not intended for use in environments such as staff kitchens of shops, offices, farms or other work environments.
- Always put the machine on a flat and stable surface.
- Do not place the machine on a hot plate, directly next to a hot oven, heater or similar source of heat.
- Only put coffee beans into the coffee bean hopper. If ground coffee, instant coffee or any other substance is put in, it may damage the machine.
- Cool down the machine before insert or remove any component.
- Never use warm or hot water to fill the water tank. Use cold water only.
- Never clean with scrubbing powders or harsh cleaners. Simply use a soft cloth dampened with water.
- Descale your machine regularly. The machine indicates when descaling is needed. Not doing this will make your appliance stop working properly. In this case repair is not covered under your warranty!
- Do not keep the machine at temperature below 0 degree Celsius. Residue water in the heating system may freeze and cause damage.
- Do not leave water in the water tank when the machine is not used over a longer period of time. The water can become contaminated. Use fresh water every time you use the machine.

Compliance with standards

The machine complies with art.13 of the Italian Legislative Decree dated 25 July 2005, no. 151 "Implementation of the directives 2005/95/EC, 2002/96/EC and 2003/108/EC on the restriction of the use of certain hazardous substances in electrical and electronic equipment, as well as waste disposal".

This machine complies with EU directive 2002/96/EC.

INSTALLATION

Product overview

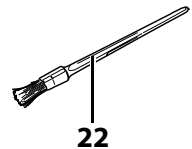
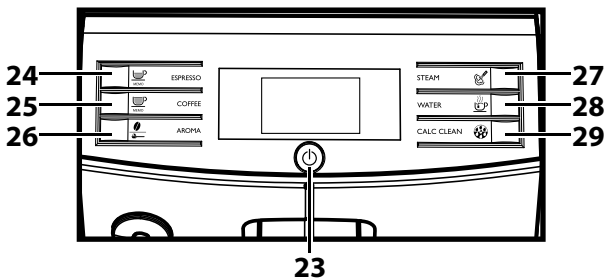
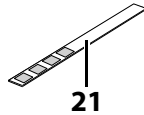
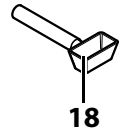
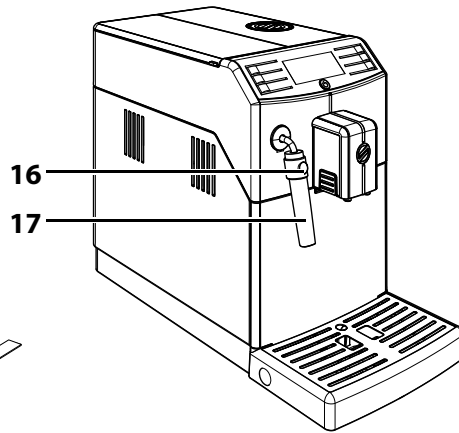
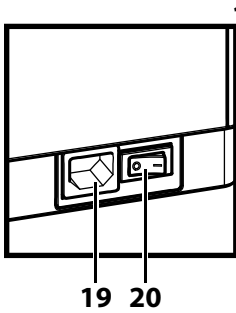
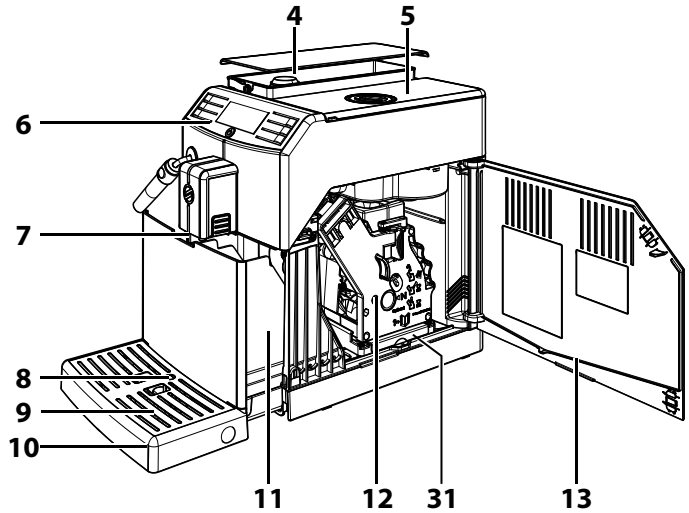
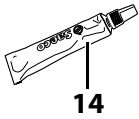
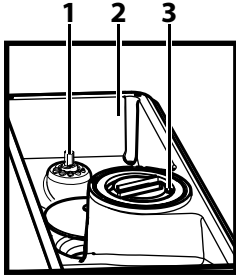

General description

1. Grinder adjustment knob
2. Coffee bean hopper
3. Pre-ground coffee compartment
4. Water tank + Lid
5. Coffee bean hopper lid
6. Control panel
7. Dispensing spout
8. Full drip tray indicator
9. Cup holder grill
10. Drip tray
11. Coffee grounds drawer
12. Brew group
13. Service door
14. Grease for the brew group
15. Power cord
16. Wand protective gripper
17. Classic Milk Frother (for hot water/steam)
18. Coffee grinder adjustment key + Pre-ground coffee scoop
19. Power cord socket
20. Power button
21. Water hardness tester strip
22. Cleaning brush
23. ON/OFF button
24. Espresso brew button
25. Coffee brew button
26. "Aroma" - Pre-ground coffee button
27. Steam button
28. Hot water button
29. Descaling button
30. Descaling solution- to be purchased separately
31. Coffee residues drawer

PREPARING FOR USE

Machine packaging

The original packaging has been designed and constructed to protect the machine during transport. We recommend keeping the packaging material for possible future transport.

Machine installation

1 Remove the machine from the packaging.

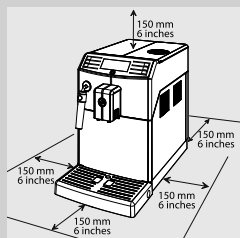

2 For best use, it is recommended to:

- Choose a safe, level surface, where there will be no danger of overturning it or being injured.
- Choose a location that is sufficiently well-lit, clean and near an easily reachable socket.
- Allow for a minimum distance from the sides of the machine as shown in the illustration.

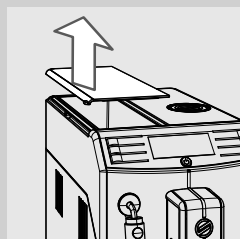

3 Remove the water tank lid.



4 Lift the water tank using the handle.

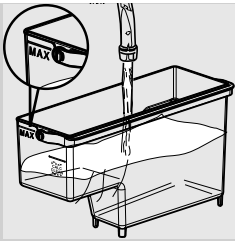

5 Rinse the water tank with fresh water.

6 Fill the water tank with fresh water up to the MAX level and reinsert it into the machine. Make sure it is fully inserted.

! **Caution:**

Never fill the water tank with warm, hot, sparkling water or any other liquid, as this may cause damage to the water tank and the machine.

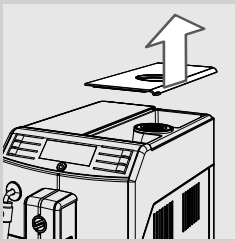

7 Remove the coffee bean hopper lid.

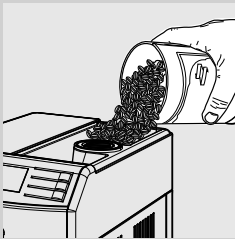

8 Slowly pour the coffee beans into the coffee bean hopper.

≡ **Note:**

Do not pour too many coffee beans into the coffee bean hopper as this will reduce the grinding performance of the machine.

! **Caution:**

Only coffee beans must be put into the coffee bean hopper. Ground coffee, instant coffee, caramelized coffee or any other object may damage the machine.

9 Put back the coffee bean hopper lid on the coffee bean hopper.

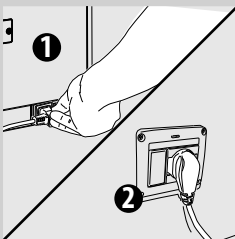

10 Insert the plug into the socket located on the back of the machine.

11 Insert the plug of the other end of the power cord into a wall socket with suitable power voltage.

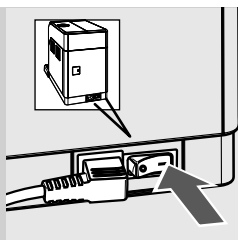

12 Switch the power button to "I" to turn on the machine. The "⏻" button blinks.

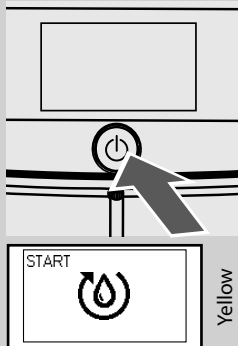

13 To turn on the machine simply press the "⏻" button. The control panel indicates that the circuit must be primed.

USING THE MACHINE FOR THE FIRST TIME

When using the machine for the first time, the following activities need to happen:

- 1) You need to prime the circuit.
- 2) The machine will perform an automatic rinse/ self-cleaning cycle.
- 3) You need to initiate a manual rinse cycle.

Circuit priming

During this process fresh water flows through the internal circuit of the machine and the machine warms up. This takes a few minutes.



1 Place a container under the Classic Milk Frother.



2 Press the “☕” button to start the cycle. The machine starts the automatic priming of the circuit by dispensing some water through the Classic Milk Frother.



Yellow

3 The bar under the icon shows the operation progress. When the process is complete, the machine stops dispensing automatically.

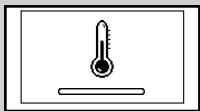

Yellow

4 Then the control panel shows the machine warm-up icon.

Automatic rinse/self- cleaning cycle

When warm-up is complete, the machine automatically performs a rinse/self-cleaning cycle of the internal circuit with fresh water. This takes less than a minute.

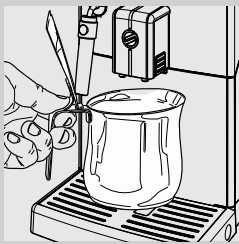

5 Place a container under the dispensing spout to catch the small amount of water which will be dispensed.



Yellow

6 The machine shows this display. Wait for the cycle to finish automatically.

Note:

You can stop dispensing by pressing the “☕” button.

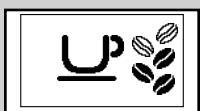

Green

7 When the above steps have been completed, the machine shows this display.

You can now proceed with the manual rinse cycle.

Manual rinse cycle

During this process you activate the coffee brewing cycle and fresh water flows through the steam/hot water circuit. This takes a few minutes.

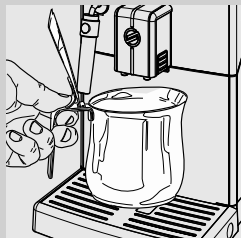

- 1 Place a container under the dispensing spout.

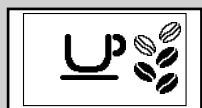

Green

- 2 Check that the machine shows this display.

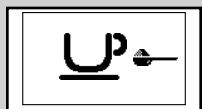

Green

- 3 Select the pre-ground coffee brewing function by pressing the "☕" button till visualizing the following display.



Note:

Do not add pre-ground coffee into the compartment.

- 4 Press the "☕" button. The machine starts dispensing water.
- 5 When the dispensing has finished, empty the container. Repeat operations from step 1 to step 4 twice, then continue with step 6.

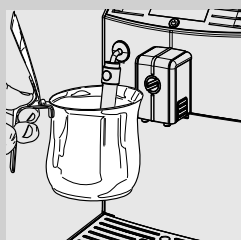

- 6 Place a container under the Classic Milk Frother.

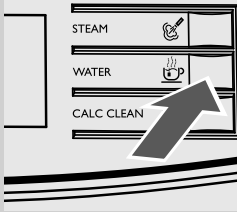

7 Press the “☕” button to start dispensing hot water.



Red

8 Dispense water until the no water icon appears.



Note:

You can interrupt the manual rinsing by pressing the “☕” button.

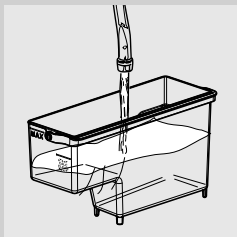

Green

9 At the end, fill the water tank again up to the MAX level. Now the machine is ready for brewing coffee.
You will see the display as shown at the left.



Note:

When you haven't used the machine for 2 or more weeks, the machine will automatically perform an automatic rinse/self-cleaning cycle after you switch it on. Thereafter you need to initiate the manual rinse cycle as described above.

The automatic rinse/self-cleaning cycle is also automatically initiated when the machine has been in stand-by mode, or switched off, for more than 15 minutes.

After this cycle has been completed, you can brew a coffee.

Measuring and programming water hardness

Measuring water hardness is very important for defining the frequency in which the machine has to be descaled and to install the "INTENZA+" water filter (for more detail on the water filter see next chapter).

To measure the water hardness follow the steps below:

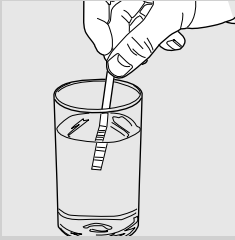

- 1** Immerse the water hardness tester strip (supplied with the machine) in water for 1 second.



Note:

The tester strip can only be used for one measurement.

- 2** Wait for one minute.

- 3** Check how many squares have changed the colour to red and then consult the table.



Note:

The numbers on the water hardness tester strip correspond to the water hardness adjustment settings.

- More precisely:
- 1 = 1 (very soft water)
 - 2 = 2 (soft water)
 - 3 = 3 (hard water)
 - 4 = 4 (very hard water)

The letters correspond to the references that are located at the base of the "INTENZA+" water filter. (see next chapter for this).

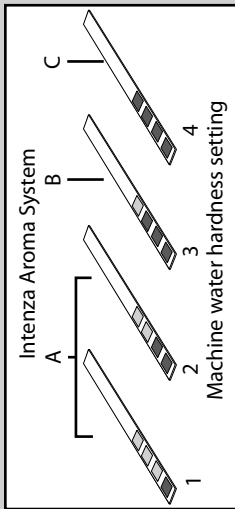

Green

- 4** Press the "☕" button and scroll the pages by pressing the "⏪" button until the following icon is displayed.



Note:

The machine is supplied with standard water hardness setting, suitable for most of the types of water.

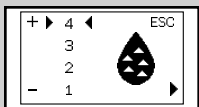

Yellow

- 5** Press the "MEMO" button to increase the value or the "⏩" button to decrease the value.

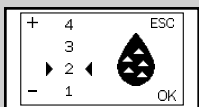

Yellow

- 6** Press the "☕" button to confirm the setting.



Green

- 7 Press the “☞” button to exit the programming MENU. The machine shows this display and is ready to brew.

“INTENZA+” water filter installation

We recommend you to install the “INTENZA+” water filter as this prevents lime scale to build up in your machine and preserves a more intense aroma to your coffee.

You can purchase separately the “INTENZA+” water filter. Please refer to the maintenance products page in this user manual for further details. Water is a crucial part of every coffee, so it's most important to always have it professionally filtered. Using the “INTENZA+” water filter will prevent mineral deposits from building up and improve your water quality.

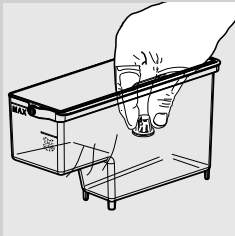

- 1 Remove the small white filter from the water tank and store it in a dry place.

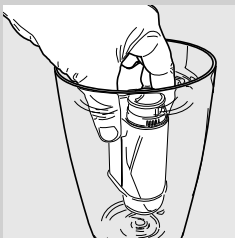

- 2 Remove the “INTENZA+” water filter from its packaging, immerse it vertically (with the opening positioned upwards) in cold water and gently press the sides so as to let the air bubbles out.

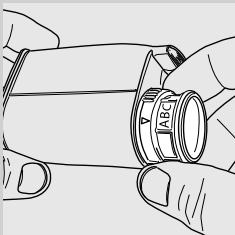

- 3 Set the “INTENZA+” water filter according to the measurements performed (see previous chapter) and indicated on the base of the filter:
 A = Soft water – equals 1 or 2 on the tester strip
 B = Hard water (standard) – equals 3 on the tester strip
 C = Very hard water – equals 4 on the tester strip

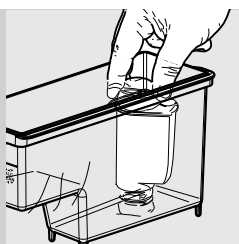

- 4 Put the "INTENZA+" water filter into the empty water tank. Press it until it cannot move further down.
- 5 Fill the water tank with fresh water and reinsert it into the machine.
- 6 Dispense the entire water tank by using the hot water function (see chapter "Hot water dispensing").
- 7 Fill the water tank again.

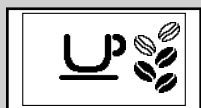

Green

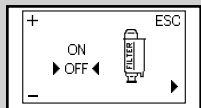

Yellow

- 8 Press the "☉" button and scroll the pages by pressing the "☉" button until the following display is displayed.

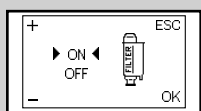

Yellow

- 9 Press the "☉" button to select "ON" and press the "☉" button to confirm.

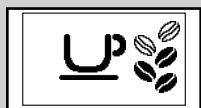

Green

- 10 To exit, press the "☉" button. The machine shows this display and is ready to brew.

In this way the machine has been programmed to inform the user of the need to replace the "INTENZA+" water filter.

Replacing the "INTENZA+" water filter

When the "INTENZA+" water filter needs to be replaced with a new one, the following icon is displayed.



Yellow

- 1 Replace the "INTENZA+" water filter as described in the previous chapter.

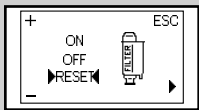

Yellow

- 2 Press the "☘" button and scroll the pages by pressing the "☘" button until the following icon is displayed.

- 3 Select the "RESET" option. Press the "☘" button to confirm.



Green

- 4 To exit, press the "☘" button. The machine shows this display and is ready to brew.

The machine is now programmed to manage a new "INTENZA+" water filter.

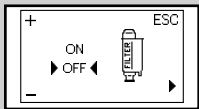

Yellow

Note:

If the "INTENZA+" water filter is already installed and you want to remove - but not replace - it, select the "OFF" option instead.

If there is no "INTENZA+" water filter installed, insert the small white filter previously removed into the water tank.

ADJUSTMENTS

The machine allows for certain adjustments so that you can brew the best tasting coffee possible.

Saeco Adapting System

Coffee is a natural product and its characteristics may change according to its origin, blend and roast. The machine is equipped with a self-adjusting system that allows the use of all types of coffee beans available on the market a part from caramelized and flavored coffee beans.

The machine automatically adjusts itself after brewing several cups of coffee to optimize the extraction of the coffee to the compactness of the ground coffee.

Adjusting the ceramic coffee grinder

Ceramic coffee grinders always guarantee accurate and perfect grinding and coarseness for every coffee specialty.

This provides for full aroma preservation, delivering the truly Italian taste in every cup.



Warning:

The ceramic coffee grinder contains moving parts that may be dangerous. Therefore, do not insert fingers and/or other objects. Only adjust the ceramic coffee grinder using the grinder adjustment key.

You can adjust the ceramic grinders to set the coffee grinding to your personal taste.



Warning:

The grinder adjustment knob, inside the coffee bean hopper, must be turned only when the ceramic coffee grinder is working.

This adjustment can be carried out by pressing and turning the grinder adjustment knob inside the coffee bean hopper, using the Coffee grinder adjustment key provided with the machine.

Adjusting the dispensing spout

The height of the dispensing spout can be adjusted to better fit the dimensions of the cups that you wish to use.

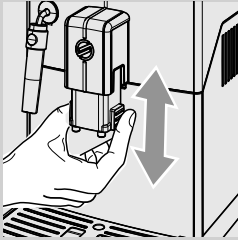

Move the dispensing spout up or down with your fingers to adjust its height as shown in the image.

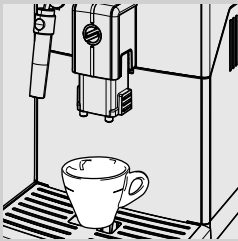

The recommended positions are:
For the use of small cups;

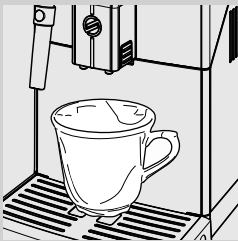

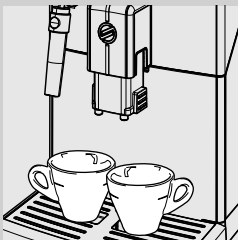

For the use of large cups.



Two cups can also be placed under the dispensing spout to brew two cups of espresso or Coffee at the same time.

Adjusting the coffee length

The machine allows you to adjust the amount of brewed coffee according to your taste and the size of your cups.

Each time the “” or “” button is pressed, the machine brews a pre-set amount of coffee. Each button may be individually programmed for a specific brew setting.

The following procedure describes the programming of the “” button.

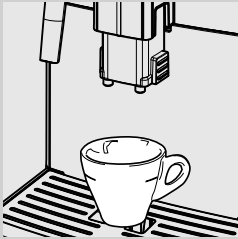

- 1 Place a cup under the dispensing spout.



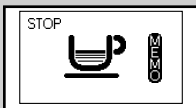

Green

- 2 Press and hold the “” button until the “MEMO” icon is displayed. Then release the button. The machine is now programming. The machine starts brewing coffee.



Green



- 3 Press the “” button as soon as the desired amount of coffee is reached.

Now the button “” is programmed; each time it is pressed, the machine will brew the same amount of espresso that was just programmed.



Note:

To program the “” button, the same steps should be followed.

You should always use the “” button to stop brewing coffee when the desired amount of coffee is reached, even when you are programming the “” button.

ESPRESSO AND COFFEE BREWING

Before brewing coffee, make sure that there are no warnings shown on the control panel, and that the water tank and coffee bean hopper are filled.

Espresso and Coffee brewing using coffee beans

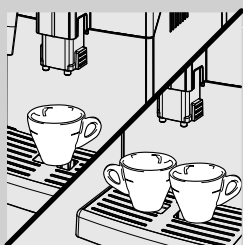

- 1 Place 1 or 2 cups under the dispensing spout.

- 2 To brew an espresso or a Coffee, press the “☕” button to select the desired aroma.

- 3 Press the “☕” button for an espresso or the “☕” button for a Coffee.

- 4 To brew 1 cup of espresso or Coffee, press the desired button once. This icon will be displayed.

- 5 To brew 2 cups of espresso or Coffee, press the desired button twice consecutively. This icon will be displayed.



Note:

In this operating mode, the machine automatically grinds and doses the correct amount of coffee. Brewing two espressos or two Coffee requires two grinding and brewing cycles, automatically carried out by the machine.

- 6 After the pre-brewing cycle, coffee begins to pour out of the dispensing spout.

- 7 Coffee brewing stops automatically when the pre-programmed level is reached; however, it is possible to stop earlier by pressing the “☕” button.



Green

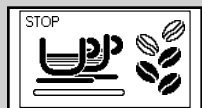

Green

Espresso and Coffee brewing using pre-ground coffee

This function allows to use pre-ground coffee.

With the pre-ground coffee function you can only brew one coffee at a time.



Green

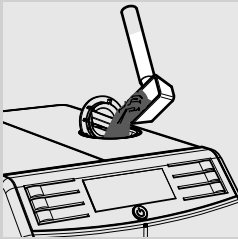

- 1 Press the “☕” button one or more times to select the pre-ground coffee function.

- 2 Lift the pre-ground coffee compartment lid and add one scoop of pre-ground coffee to the compartment. Use only the measuring scoop supplied with the machine then close the pre-ground coffee compartment lid.



Warning:

Add only pre-ground coffee to the pre-ground coffee compartment. Other substances and objects may cause severe damages to the machine. Such damages are not covered by your warranty.

- 3 Press the “☕
MEMO” button for an espresso or “☕
MEMO” button for a coffee. The brewing cycle starts.

- 4 After the pre-brewing cycle, coffee begins to pour out of the dispensing spout.

- 5 Coffee brewing stops automatically when the pre-programmed level is reached; it is possible to stop earlier by pressing the “☕
MEMO” button.

After brewing the product, the machines returns to the main menu.

Repeat the steps described above to brew more coffees using pre-ground coffee.



Note:

If no pre-ground coffee is poured into the pre-ground coffee compartment, only water will be dispensed.

If the dose is excessive and 2 or more pre-ground coffee scoop of coffee are used, the machine will not brew the product and any ground coffee will be discharged into the coffee grounds drawer.

STEAM DISPENSING /CAPPUCCINO BREWING

**Warning:**

Danger of scalding! Dispensing may be preceded by small jets of hot water. The Classic Milk Frother may reach high temperatures. Never touch it with bare hands. Use the appropriate protective handle only.

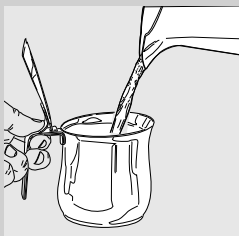

- 1 Fill 1/3 of a container with cold milk.

**Note:**

Use cold (~5°C / 41°F) milk with a protein content of at least 3% to ensure optimum results when preparing a cappuccino. You can use whole milk or low-fat milk depending on your personal taste.

**Note:**

When you plan to dispense steam right after switching on the machine or after brewing a coffee, some water still present in the circuit may need to be dispensed first.

For this press the "☞" button to dispense steam for a few seconds. Thereafter press the "☞" button to stop. Proceed with step 2.

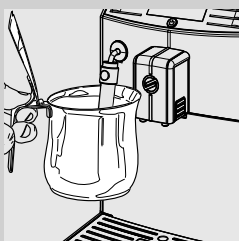

- 2 Immerse the Classic Milk Frother in the milk.

- 3 Press the "☞" button to start dispensing steam.

**Note:**

After 3 minutes the steam dispensing will stop. Push "☞" button to dispense again.

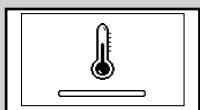

Yellow

- 4 The following icon may be displayed during the preheating time required by the machine.

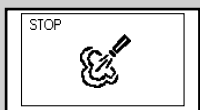

Green

- 5 Froth the milk by gently swirling the container and moving it up and down.

- 6 When the milk froth has the desired consistency, press "☞" button to stop dispensing steam.



Note:

After having pressed the “☕” button it will take a few seconds before the machine stops dispensing completely.



Caution:

Each time after frothing the milk you need to dispense a small amount of hot water into a container.

Remove the external part of the Classic Milk Frother and wash it with lukewarm water.



Note:

After dispensing steam, it is possible to brew an espresso or dispense hot water straight after.

HOT WATER DISPENSING



Warning:

Danger of scalding! Dispensing may be preceded by small jets of hot water. The Classic Milk Frother may reach high temperatures: never touch it with bare hands. Use the appropriate protective handle only.

Before dispensing hot water, check that the machine is ready to use and the water tank is filled.

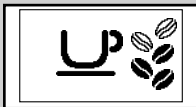

Green

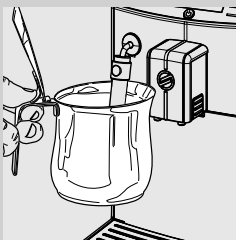

- 1 Place a container under the Classic Milk Frother.

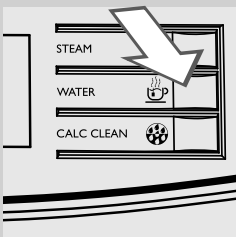

- 2 Press the “☕” button to start dispensing hot water.

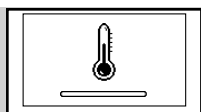

Yellow



Green

3 The following icon may be displayed during the preheating time required by the machine.

4 Pour the desired amount of hot water. To stop the hot water dispensing press the "☕" button.

CLEANING AND MAINTENANCE

Daily cleaning of the machine



Caution:

Timely cleaning and maintenance of your machine is very important as it prolongs the life of your machine. Your machine gets exposed to moist, coffee and lime scale continuously! In this chapter it is described in detail which activities you need to perform at which frequency. Not doing this will ultimately make your machine stop working properly. This repair is NOT covered by your warranty!



Note:

- Use a soft, dampened cloth to clean the machine.
- You may only wash the cup holder grill in the washing machine; the other parts need to be washed in lukewarm water.
- Do not immerse the machine in water.
- Do not use alcohol, solvents, and/or abrasive objects to clean the machine.
- Do not dry the machine and/or its components using a microwave and/or standard oven.

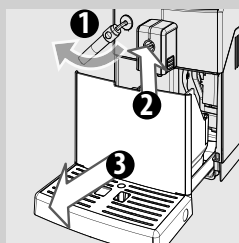

1 Empty and clean the coffee grounds drawer and the drip tray daily with the machine turned on.

Other maintenance operations can only be carried out when the machine is turned off and unplugged.

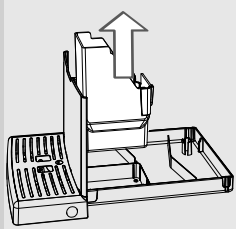

2 Remove the coffee grounds drawer and empty it.

3 Empty and clean the drip tray.

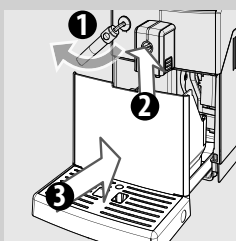

4 Insert the coffee grounds drawer back into the drip tray and this into the machine.

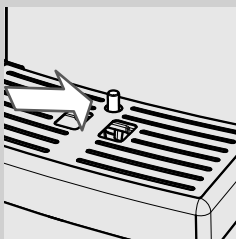

Note:

Empty the drip tray also when the full drip tray indicator is raised.

Daily cleaning of the water tank

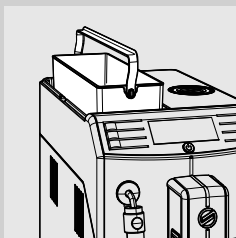

1 Remove the small white filter or the "INTENZA+" water filter (if installed) from the water tank and wash it with fresh water.

2 Put the small white filter back or the "INTENZA+" water filter (if installed) in its housing by gently pressing and turning it at the same time.

3 Fill the water tank with fresh water.

Daily cleaning of the Classic Milk Frother

It is important that you clean the Classic Milk Frother daily or after each use as it preserves hygiene and ensures perfect milk froth consistency.

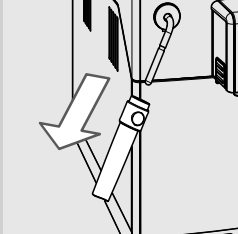

Each time after frothing the milk you need to dispense a small amount of hot water into a container.

Remove the external part of the Classic Milk Frother and wash it with lukewarm water.

Weekly cleaning of the machine

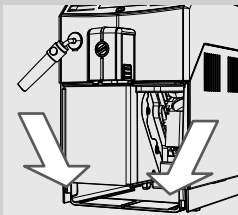

1 Clean the seat of the drip tray.

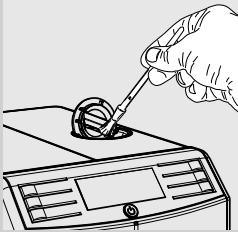

2 Clean the pre-ground coffee compartment with the cleaning brush.

Weekly cleaning of the Classic Milk Frother

The weekly cleaning is more thorough as you need to disassemble all parts of Classic Milk Frother.

You need to perform the following cleaning operations:

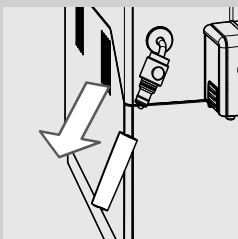

1 Remove the external part of the Classic Milk Frother. Wash it with lukewarm water.

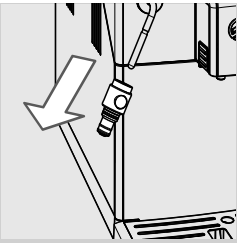

- 2** Remove the upper part of the Classic Milk Frother from the hot water/steam wand.
- 3** Wash the upper part of the Classic Milk Frother with fresh water.
- 4** Clean the hot water/steam wand of the Classic Milk Frother with a wet cloth to remove milk residues.
- 5** Put the upper part back in the hot water/steam wand (make sure it is completely inserted).
- 6** Reassemble the external part of the Classic Milk Frother.

Weekly cleaning of the brew group

The brew group should be cleaned every time the coffee bean hopper is filled or at least once a week.

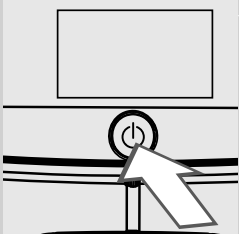

- 1** Turn off the machine by pressing the “⏻” button and unplug the power cord.

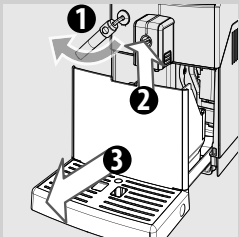

- 2** Remove the drip tray and coffee grounds drawer. Only at this time open the service door.

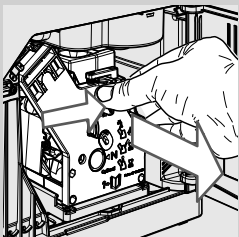

- 3** To remove the brew group, press the «PUSH» button and pull it by the handle.

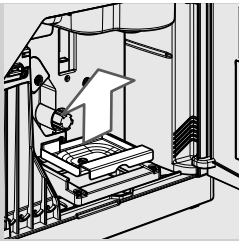

4 Remove the coffee residues drawer and wash it thoroughly.

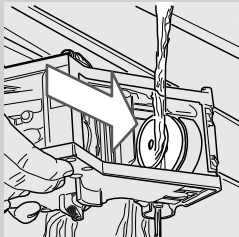

5 Thoroughly wash the brew group with fresh, lukewarm water and carefully clean the upper filter.

! **Caution:**

Do not use detergent/soap to clean the brew group.

6 Let the brew group air-dry thoroughly.

7 Thoroughly clean the inside of the machine using a soft, dampened cloth.

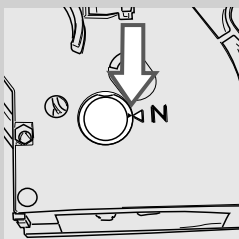

8 Make sure the brew group is in the rest position; the two reference signs must match. If they do not match, proceed as described in step (9).

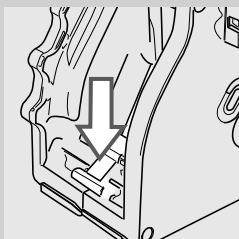

9 Gently pull down the lever until it is in contact with the brew group base and the two reference signs on the side of the brew group do match.

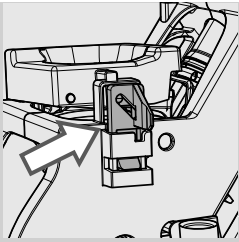

- 10** Make sure the hook to lock the brew group is in the correct position by firmly pressing the "PUSH" button until you hear a click. Check if the hook is at the top end position. If it is not, please try again.

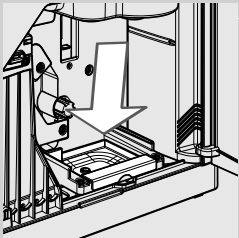
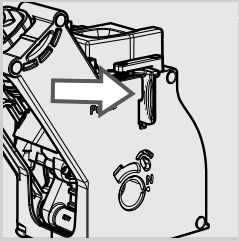

- 11** Insert the coffee residues drawer in its seat and ensure that it is correctly in place.



Note:

If the coffee residues drawer is not correctly positioned, the brew group may not fit into the machine.

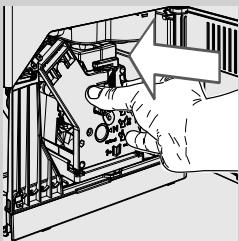

- 12** Insert the brew group in its seat again until it locks into place without pressing the "PUSH" button.

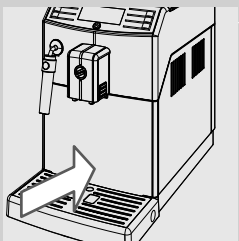

- 13** Insert the coffee grounds drawer with the drip tray back into the machine and close the service door.

Monthly lubrication of the brew group

Lubricate the brew group after approximately 500 cups of coffee or once a month. You can purchase the grease for the brew group separately to lubricate the brew group. Please refer to the maintenance products page in this user manual for further details.

**Caution:**

Before lubricating the brew group, clean it under fresh water and let it dry, as described in the "Weekly cleaning of the brew group" chapter.

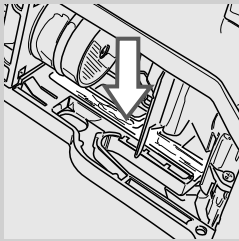
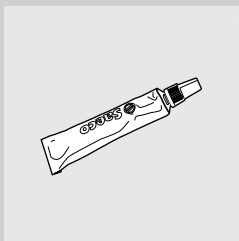

- 1** Apply the grease evenly on both side guides.

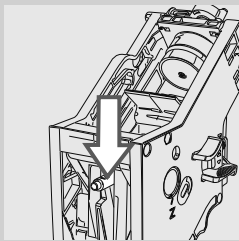
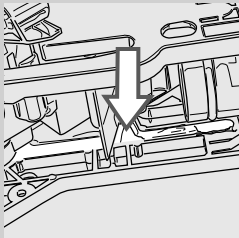

- 2** Lubricate the shaft too.

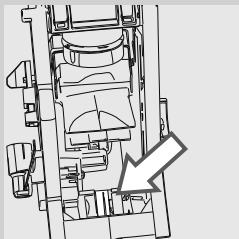

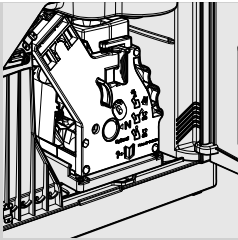

3 Insert the brew group in its seat until it locks into place. (see “Weekly Cleaning of the Brew Group” chapter).

4 Close the service door and insert the drip tray and the coffee grounds drawer.

Monthly cleaning of the brew group with “Coffee Oil Remover”



Besides weekly cleaning, we recommend running this cleaning cycle with the “Coffee Oil Remover” after approximately 500 cups of coffee or once a month. This operation completes the maintenance process of the brew group.

You can purchase separately the “Coffee Oil Remover”. Please refer to the maintenance products page in this user manual for further details.



Caution:

The “Coffee Oil Remover” tablets are to be used for cleaning only and do not have a descaling function. For the descaling procedure use the Saeco descaling solution and follow the procedure described in the “Descaling” chapter.

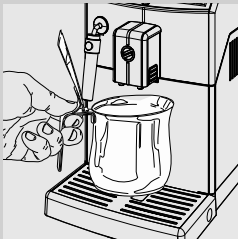

1 Place a container under the dispensing spout.

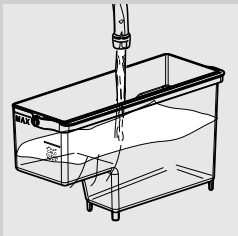

2 Make sure the water tank is filled with fresh water up to the “MAX” level.

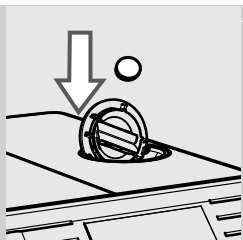

3 Put a "Coffee Oil Remover" tablet in the pre-ground coffee compartment.

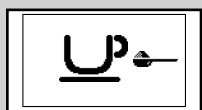

4 Press the "☕" button to select the pre-ground coffee function, without adding ground coffee.

5 Press the "MEMO" button to start a coffee brewing cycle.

6 Wait until the machine has dispensed half a cup of water.

7 Switch the power button on the back of the machine to "0".

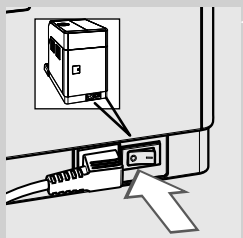

8 Let the solution take effect for approximately 15 minutes. Make sure you discard the dispensed water.

9 Switch the power button on the back of the machine to "I". To turn on the machine press the "☺" button. Wait until the automatic rinse cycle has been completed.

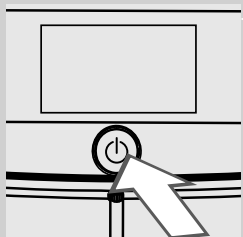

10 Remove the drip tray and the coffee grounds drawer and open the service door. Remove the brew group.

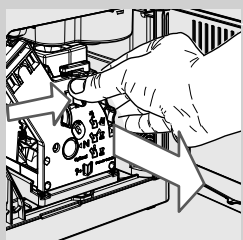

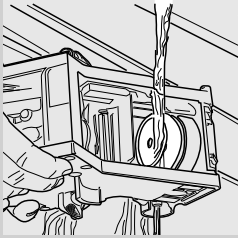

11 Wash the brew group thoroughly with fresh water.

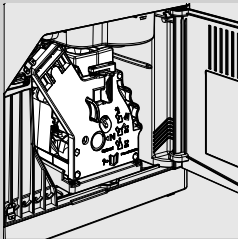

12 After rinsing the brew group, insert it again in its seat until it locks into place (see "Weekly cleaning of the brew group" chapter). Insert the drip tray and the coffee grounds drawer. Close the service door.



Green

13 Press the "☕" button to select the pre-ground coffee function, without adding coffee to the pre-ground coffee compartment.

14 Press the "☕" button to start a coffee brewing cycle.

15 Repeat steps 13 - 14 twice. Make sure you discard the dispensed water.

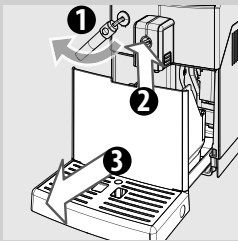

16 To clean the drip tray, place a "Coffee Oil Remover" tablet inside and fill it up to 2/3rds full with hot water. Let the cleaning solution take effect for about 30 minutes, then rinse thoroughly.

Monthly cleaning of the coffee bean hopper

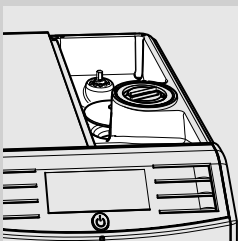

Clean the coffee bean hopper once a month when it is empty with a damp cloth to remove coffee oil. Thereafter refill it with coffee beans.

DESCALING

The descaling process takes approx. 35 minutes.



Yellow

Lime scale builds up inside the machine during use. It needs to be removed regularly as it may clog the water and coffee circuit of your machine. The machine tells you when descaling is needed. If the machine display shows the **CALC CLEAN** icon, it means that you need to descale.

**Caution:**

Not doing this will ultimately make your machine stop working properly, and in this case repair is NOT covered by your warranty.



Use the Descaling solution only. Its formula has been designed to ensure better machine performance.

You can purchase separately the Descaling solution. Please refer to the maintenance products page in this user manual for further details.

**Warning:**

Never drink the Descaling solution or any products dispensed until the cycle has been carried out to the end. Never use vinegar as a decalcifier.

**Note:**

During the descaling cycle do not switch off the machine. If this has happened you have to restart the descaling cycle to fully complete it. It will restart from the point the descaling cycle had previously been left.

To execute the descaling cycle, follow the steps below:

Before descaling:

- 1 Empty the drip tray and the coffee grounds drawer.

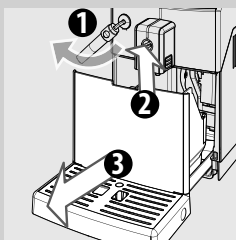

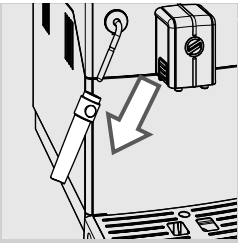

2 Remove the Classic Milk Frother from the hot water/steam wand.

3 Remove the "INTENZA+" water filter from the water tank if it was installed and replace it with the small white original one. Place the water tank back into the machine.

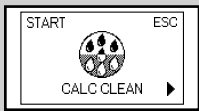

Yellow

4 Press the "☘" button.

5 Press the "☕" button to start the descaling process.

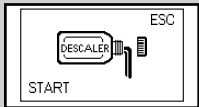

Yellow

Note:

If you press the "☕" button by mistake, press the "☘" button to quit.

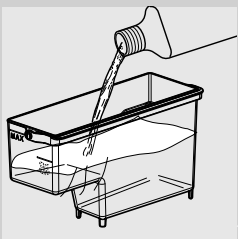

6 Remove the water tank and pour the entire content of the Descaling solution. Then fill the water tank with fresh water up to the calc clean level.

7 Place the water tank back into the machine.

Empty the drip tray and coffee grounds drawer and place them back.

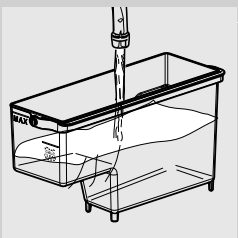

8 Place a large container (1.5L) under both the steam/hot water wand and the dispensing spout.

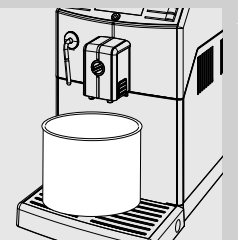

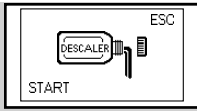

Yellow

9 Press the “” button to start the descaling cycle.

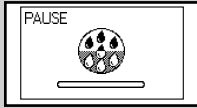



Yellow

10 The machine will start dispensing the descaling solution at intervals. The bar on the control panel shows the cycle progress.



Note:

The descaling cycle may be paused by pressing the “” button. To resume the cycle, press the “” button again. This allows you to empty the container or to stay away from the machine for a brief period of time.

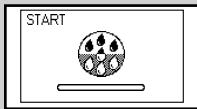

Yellow



Red

11 When this icon is displayed, the water tank is empty.

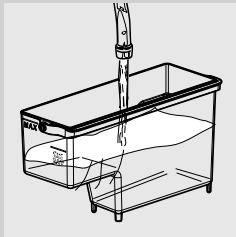

12 Remove the water tank, rinse it and fill it up to the MAX level with fresh water. Place it back into the machine. When inserting the water tank into the machine, the display below is displayed.

13 Empty the drip tray and servings container and place it back.

14 Empty the container and place it back under the steam/hot water wand and dispensing spout.



Yellow

15 Press the “” button to start the rinsing cycle.



Red

16 When this icon is displayed, the water tank is empty. Repeat steps 12-15. When the machine shows this icon again, continue with step 17.

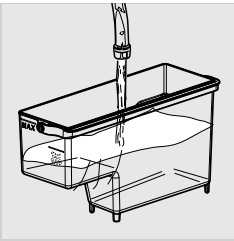

17 When the water tank is empty, remove the water tank, rinse it and fill it up to the MAX level with fresh water. Place it back into the machine.



Green

18 Empty the container and place it back under the steam/hot water wand and dispensing spout.

19 When the amount of water needed for the rinse cycle has been completely dispensed, this icon on the side is displayed. Press the  button to quit the descaling cycle.

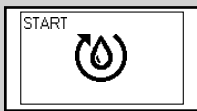

Yellow

20 Press the  button to prime the circuit.

21 The machine now carries out the warm-up and automatic rinse cycle to prepare for product brewing.

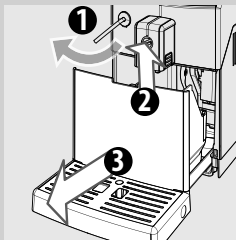

22 Remove and empty the container.

23 Empty the drip tray and place it back.

24 The descaling cycle is now complete.

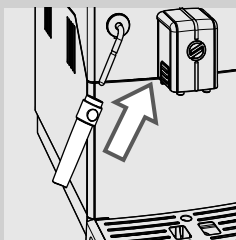

25 Remove the small white water filter and place back the "INTENZA+" water filter into the water tank if it was installed and the Classic Milk Frother.

 **Note:**

At the end of the descaling cycle, wash the brew group as described in the "Weekly cleaning of the brew group" chapter.

The two rinse cycles are performed in order to have the circuit cleaned with a preset amount of water to ensure proper machine performance. If the water tank is not filled up to MAX level, the machine might require three or more cycles.

MEANING OF THE DISPLAY SYMBOLS

This machine is equipped with a colour-coded system to make the user's understanding of the display signals easier. The icons are colour-coded according to the traffic light principle.

Ready Signals (Green Colour)



The machine is ready to brew products.

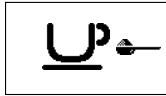

The machine is ready to brew pre-ground coffee.



Hot water dispensing.



Steam dispensing.

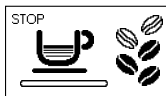

The machine is brewing one cup of espresso.

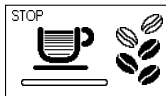

The machine is brewing one cup of Coffee.

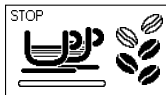

The machine is brewing two cups of espresso.

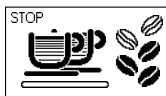

The machine is brewing two cups of Coffee.



The machine is programming the amount of coffee to be brewed.

Ready Signals (Green Colour)

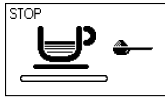

Coffee brewing using pre-ground coffee in progress.

Warning Signals (Yellow Colour)

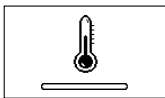

The machine is heating-up to brew beverages or dispense hot water.



The machine performs the rinsing cycle. Wait until the machine has completed the cycle.



The machine needs the "INTENZA+" water filter to be replaced.



The brew group is being reset due to machine reset.



Refill the coffee bean hopper with coffee beans and restart the cycle.

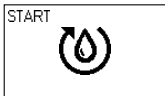

Prime the circuit.

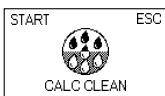

The machine needs to be descaled. Press the "☕" button to start the descaling process. Follow the steps described in the "Descaling" chapter of this manual.

If you want to descale later, press the "☞" button to continue using the machine.

Please note that not descaling your machine will ultimately make it stop working properly. In this case repair is NOT covered under your warranty.

Warning Signals (Red Colour)



Completely insert the drip tray with the coffee grounds drawer into the machine and close the service door.



Fill the coffee bean hopper.



The brew group must be inserted into the machine.

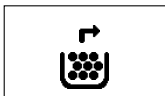

Empty the coffee grounds drawer.



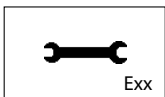

Fill the water tank.



Turn off the machine. After 30 seconds, turn it on again. Try this 2 or 3 times. If the machine does not start, contact the Philips SAECO hotline in your country and communicate the Error-code which you see on the display. You can find its contact details in the warranty booklet by-packed separately or on www.philips.com/support.

TROUBLESHOOTING

This chapter summarizes the most common problems you could encounter with your machine. If you are unable to solve the problem with the information below, visit www.philips.com/support for a list of frequently asked questions or contact the Philips Saeco hotline in your country. You find its contact details in the warranty booklet by-packed separately or on www.philips.com/support.

Machine actions	Causes	Solutions
The machine does not switch on.	The machine is not connected to the electric network, or the main switch is in "O" position.	Connect the machine to the electric network, turn the main switch to "I" position
The drip tray gets filled although no water is drained.	Sometimes water is drained automatically by the machine into the drip tray to manage the rinsing of the circuits and ensure optimum machine performance.	This is seen as normal machine behavior.
The red  icon is always displayed on the machine.	The coffee grounds drawer was emptied with the machine off.	The coffee grounds drawer must always be emptied with the machine on. Wait until the  icon is displayed before refitting the drawer.
Coffee is not hot enough.	The cups are cold.	Preheat the cups with hot water.
No hot water or steam is dispensed.	The hole of the hot water / steam wand is clogged.	Clean the hole of the steam wand using a pin. Make sure that the machine is off and cold before performing this operation.
	Classic Milk Frother is dirty.	Clean the Classic Milk Frother.
Coffee does not have enough crema. (See note)	The blend is unsuitable, coffee is not freshly roasted or the grind is too coarse.	Change coffee blend or adjust the grinder as explained in chapter "Adjusting the ceramic coffee grinder".
The machine takes a long time to warm up or the amount of water dispensed is too little.	The machine circuit is clogged by limescale.	Descale the machine.
The brew group cannot be removed.	The brew group is out of place.	Turn the machine on. Close the service door. The brew group automatically returns to the initial position.
	The coffee grounds drawer is inserted.	Remove the coffee grounds drawer before removing the brew group.

Machine actions	Causes	Solutions
The machine grinds the coffee beans but no coffee comes out. (See note)	There is no water.	Fill the water tank and prime the circuit (chapter "Using the machine for the first time").
	The brew group is dirty.	Clean the brew group ("Weekly cleaning fo the brew group" chapter).
	The circuit is not primed.	Prime the circuit (chapter "Using the machine for the first time").
	This might occur when the machine is automatically adjusting the dose.	Brew a few cups of coffee as described in chapter "Saeco Adapting System".
Coffee is too weak. (See note)	The dispensing spout is dirty.	Clean the dispensing spout.
	This might occur when the machine is automatically adjusting the dose.	Brew a few cups of coffee as described in chapter "Saeco Adapting System".
Coffee is brewed slowly. (See note)	The coffee grind is too fine.	Change coffee blend or adjust the grind as explained in chapter "Adjusting the ceramic coffee grinder".
	The circuit is not primed.	Prime the circuit (chapter "Using the machine for the first time").
	The brew group is dirty.	Clean the brew group ("Weekly cleaning fo the brew group" chapter).
Coffee leaks out of the dispensing spout.	The dispensing spout is clogged.	Clean the dispensing spout and its holes.

**Note:**

These problems can be considered normal if the coffee blend has been changed or if the machine has just been installed. In this case wait until the machine performs a self-adjusting operation as described in chapter "Saeco Adapting System".

ENERGY SAVING

Stand-by

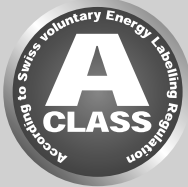

The Saeco full automatic espresso machine is designed for energy saving-proven by the Class A energy label.

After 30 minutes of inactivity the machine turns off automatically (unless you have differently programmed the stand-by time). If a product has been brewed the machine performs a rinsing cycle.

In stand-by mode, the energy consumption is below 1Wh.

To turn on the machine, press "I" button (if power button on the back of the machine is set to "I"). If the boiler is cold the machine performs a rinsing cycle.

Disposal



Do not throw away the machine with the normal household waste at the end of its life, but hand it in at an official collection point for recycling. By doing this, you help to preserve the environment.

- The packing materials can be recycled.
- Machine: unplug the machine and cut the power cord
- Deliver the appliance and power cord to a service center or public waste disposal facility.

This product complies with EU directive 2002/96/EC.

The symbol on the product or on its packaging indicates that this product may not be treated as household waste.

Instead it shall be handed over to the applicable collection point for the recycling of electrical and electronic equipment.

By ensuring this product is disposed of correctly, you will help prevent potential negative consequences for the environment and human health, which could otherwise be caused by inappropriate waste handling of this product. For more detailed information about recycling of this product, please contact your local city office, your household waste disposal service or the shop where you purchased the product.

TECHNICAL SPECIFICATION

The manufacturer reserves the right to make changes to the technical specifications of the product

Nominal Voltage - Power Rating - Power Supply	See label on the inside of the service door
Housing material	Thermoplastic material
Size (w x h x d)	215 x 330 x 429 mm
Weight	6.7 kg
Power Cord Length	1.2 m
Control Panel	On the front
Classic Milk Frother	Special for cappuccino
Size of cup	Up to 152 mm
Water Tank	1.8 liters – Removable type
Coffee Bean Hopper Capacity	250 gr
Coffee grounds drawer capacity	15
Pump pressure	15 bar
Boiler	Stainless steel type
Safety mechanisms	Thermal fuse

GUARANTEE AND SERVICE

Guarantee

For detailed information on your warranty and related conditions, please read the warranty booklet by-packed separately.

Service

We want to ensure that you remain satisfied with your machine. If not done already, please register your product on www.philips.com/welcome so that we can stay in contact with you and send you cleaning and descaling reminders.

If you need service or support, please visit the Philips website at www.philips.com/support or contact the Philips Saeco hotline in your country. You find its phone number in the warranty booklet by packed separately or on www.philips.com/support.

ORDERING MAINTENANCE PRODUCTS

For cleaning and descaling, use Saeco maintenance products only. You can purchase these at the Philips online shop at www.shop.philips.com/service, your local dealer or at authorised service centers.

If you have any difficulties obtaining maintenance products for your machine, please contact the Philips Saeco hotline in your country.

You find its contact details in the warranty booklet by-packed separately or on www.philips.com/support.

Overview of maintenance products



- Decalcifier CA6700



- INTENZA+ Water filter cartridge CA6702

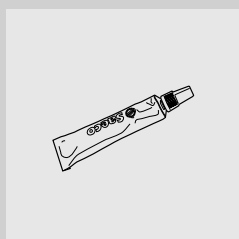

- Grease HD5061



- Coffee Oil Remover CA6704



- Maintenance Kit CA 6706

Rev.00 del 15-02-13



421940438211

EN

02

The manufacturer reserves the right to make changes without prior notice.



www.philips.com/welcome

Free Manuals Download Website

<http://myh66.com>

<http://usermanuals.us>

<http://www.somanuals.com>

<http://www.4manuals.cc>

<http://www.manual-lib.com>

<http://www.404manual.com>

<http://www.luxmanual.com>

<http://aubethermostatmanual.com>

Golf course search by state

<http://golfingnear.com>

Email search by domain

<http://emailbydomain.com>

Auto manuals search

<http://auto.somanuals.com>

TV manuals search

<http://tv.somanuals.com>