



02

English

Minuto

USER MANUAL

Type HD8772

Read carefully before using the machine.



EN

02



Register your product and get support at

www.philips.com/welcome

IMPORTANT SAFEGUARDS

When using electrical appliances, basic safety precautions should always be followed, including the following:

1. Read all instructions.
2. Do not touch hot surfaces. Use handles or knobs.
3. To protect against fire, electric shock and injury to persons do not immerse cord, plugs, or appliance in water or other liquid.
4. Close supervision is necessary when the appliance is used by or near children.
5. Unplug from outlet when not in use and before cleaning. Allow to cool before putting on or taking off parts, and before cleaning the appliance.
6. Do not operate any appliance with a damaged cord or plug or after the appliance malfunctions, or has been damaged in any manner. Return appliance to the nearest authorized service facility for examination, repair or adjustment.
7. The use of accessory attachments not recommended by the appliance manufacturer may result in fire, electric shock or injury to persons.
8. Do not use outdoors.
9. Do not let cord hang over edge of table or counter, or touch hot surfaces.
10. Do not place on or near a hot gas or electric burner, or in a heated oven.
11. Always attach plug to appliance first, then plug cord into wall outlet. To disconnect, turn any control to "off", then remove plug from wall outlet.
12. Do not use appliance for other than intended use.
13. Save these instructions.

SAVE THESE INSTRUCTIONS

CAUTION

This appliance is for household use only. Any servicing, other than cleaning and user maintenance, should be performed by an authorized service center. Do not immerse machine in water. To reduce the risk of fire or electric shock, do not disassemble the machine. There are no parts inside the machine serviceable by the user. Repair should be done by authorized service personnel only.

1. Check voltage to be sure that the voltage indicated on the nameplate corresponds with your voltage.
2. Never use warm or hot water to fill the water tank. Use cold water only.
3. Keep your hands and the cord away from hot parts of the appliance during operation.
4. Never clean with scrubbing powders or harsh cleaners. Simply use a soft cloth dampened with water.
5. For optimal taste of your coffee, use purified or bottled water. Periodic descaling is still recommended every 2-3 months.
6. Do not use caramelized or flavored coffee beans.

INSTRUCTIONS FOR THE POWER SUPPLY CORD

- A. A short power-supply cord (or detachable power-supply cord) is to be provided to reduce risks resulting from becoming entangled in or tripping over a longer cord.
- B. Longer detachable power-supply cords or extension cords are available and may be used if care is exercised in their use.
- C. If a long detachable power-supply cord or extension cord is used,
 1. The marked electrical rating of the detachable power-supply cord or extension cord should be at least as great as the electrical rating of the appliance
 2. If the appliance is of the grounded type, the extension cord should be a grounding-type 3-wire cord, and
 3. The longer cord should be arranged so that it will not drape over the counter top or table top where it can be pulled on by children or tripped over.

*Congratulations on your purchase of a Saeco Minuto Automatic Milk Frother full automatic coffee machine!
To fully benefit from the support that Saeco offers, please register your product at **www.philips.com/welcome**.
This user manual applies to HD8772.
The machine is made for preparing espresso and coffee using whole coffee beans and for dispensing steam and hot water. In this user manual you will find all the information you need to install, use, clean and descale your machine.*

CONTENTS

INSTALLATION	4
Product Overview	4
General Description	5
PREPARING FOR USE	6
Machine Packaging	6
Machine Installation	6
USING THE MACHINE FOR THE FIRST TIME	8
Circuit Priming	8
Automatic Rinse/Self-Cleaning Cycle	9
Manual Rinse Cycle	10
Measuring and Programming Water Hardness	12
"INTENZA+" Water Filter Installation	13
Replacing the "INTENZA+" Water Filter	15
ADJUSTMENTS	16
Saeco Adapting System	16
Adjusting the Ceramic Coffee Grinder	16
Adjusting the Aroma (Beverage Strength)	17
Adjusting the Dispensing Spout	18
"ESPRESSO" or "COFFEE" selection lever	19
Adjusting the Beverage Cup Length	21
BREWING AN "ESPRESSO"	22
Brewing an Espresso using Coffee Beans	22
Brewing an Espresso using Pre-Ground Coffee	23
BREWING A COFFEE	24
Brewing a Coffee Using Coffee Beans	24
Brewing a coffee Using Pre-Ground Coffee	25
DISPENSING STEAM/CAPPUCCINO BREWING	27
HOT WATER DISPENSING	29
CLEANING AND MAINTENANCE	31
Daily Cleaning of the Machine	31
Daily Cleaning of the Water Tank	32
Daily Cleaning of the Automatic Milk Frother	33
Weekly Cleaning of the Machine	34
Weekly Cleaning of the Brew Group	35
Monthly Cleaning of the Automatic Milk Frother	37
Monthly Lubrication of the Brew Group	43
Monthly Cleaning of the Brew Group with "Coffee Oil Remover"	44
Monthly Cleaning of the Coffee Bean Hopper	46
DESCALING	47
PROGRAMMING	51
The following settings can be adjusted	51
How to Program the Machine	52
MEANING OF THE DISPLAY ICONS	54
TROUBLESHOOTING	58
ENERGY SAVING	60
Stand-by	60
Disposal	60
TECHNICAL SPECIFICATIONS	61
WARRANTY AND SERVICE	61
Warranty	61
Service	61
ORDERING MAINTENANCE PRODUCTS	62

INSTALLATION

Product Overview

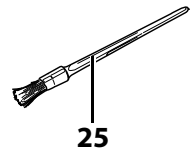
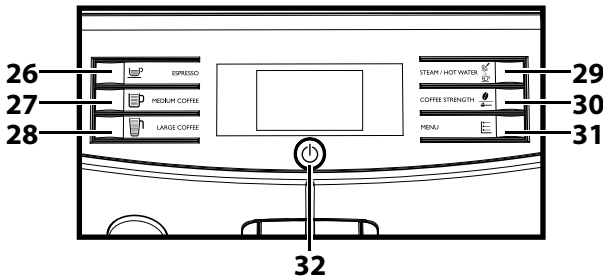
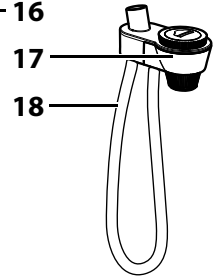
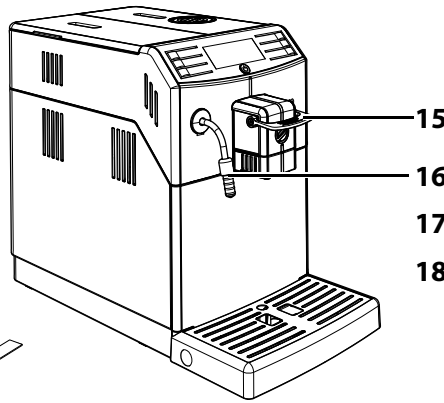
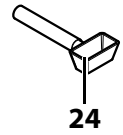
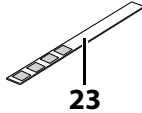
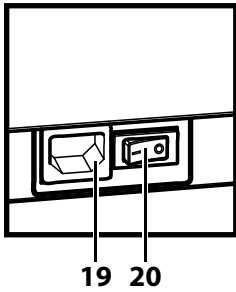
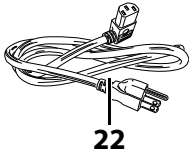
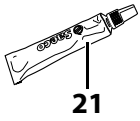
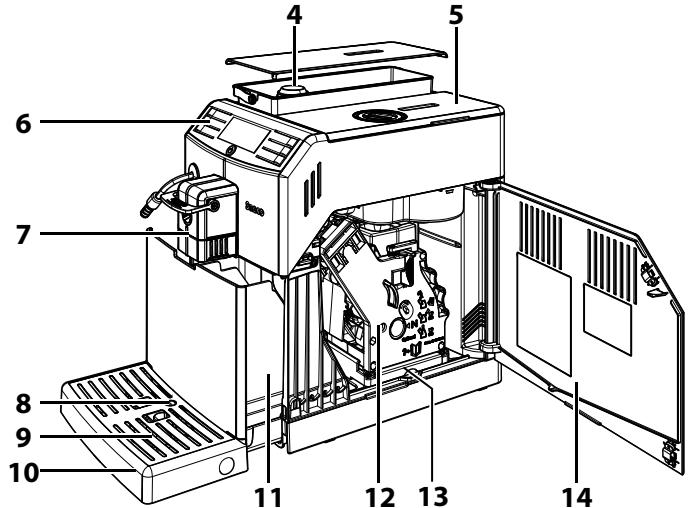
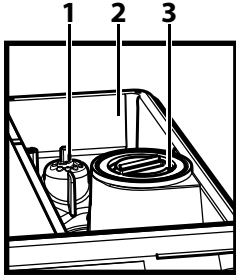

General Description

1. Grinder adjustment knob
2. Coffee bean hopper
3. Pre-ground coffee compartment
4. Water tank + Lid
5. Coffee bean hopper lid
6. Control panel
7. Espresso / coffee dispensing spout
8. Full drip tray indicator
9. Cup holder grill
10. Drip tray
11. Coffee grounds drawer
12. Brew group
13. Coffee residues drawer
14. Service door
15. Espresso/Coffee selection lever
16. Steam wand + rubber grip for Automatic Milk Frother
(also for hot water dispensing)
17. Automatic Milk Frother (also for steam dispensing)
18. Suction tube for Automatic Milk Frother
19. Power cord socket
20. Power button
21. Grease for the brew group
22. Power cord
23. Water hardness test strip
24. Coffee grinder adjustment key + Pre-ground coffee scoop
25. Cleaning brush
26. Espresso brew button
27. Medium coffee brew button
28. Long coffee brew button
29. Hot water/steam button
30. "Aroma" - Pre-ground coffee button
31. Menu button
32. ON/OFF button
33. Descaling solution- to be purchased separately

PREPARING FOR USE

Machine Packaging

The original packaging has been designed and constructed to protect the machine during transport. We recommend keeping the packaging material for possible future transport.

Machine Installation

1 Remove the machine from the packaging.

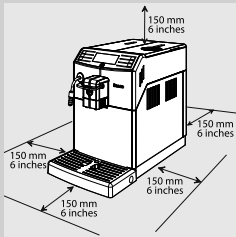

2 For best use, it is recommended to:

- Choose a safe, level surface, where there will be no danger of overturning the machine or being injured.
- Choose a location that is sufficiently well-lit, clean and near an easily reachable socket.
- Allow for a minimum distance from the sides of the machine as shown in the illustration.

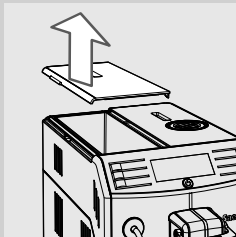

3 Remove the water tank lid.

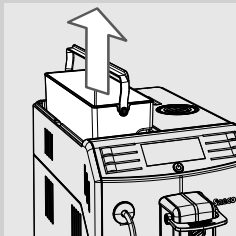

4 Lift the water tank using the handle.

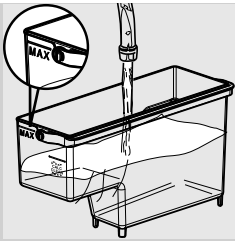

5 Rinse the water tank with fresh water.

6 Fill the water tank with fresh water up to the MAX level and reinsert it into the machine. Make sure it is fully inserted.



Caution:

Never fill the water tank with warm, hot, sparkling water or any other liquid, as this may cause damage to the water tank and the machine.

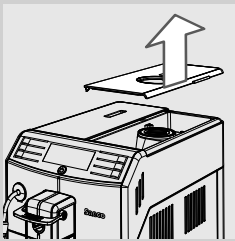

7 Remove the coffee bean hopper lid.

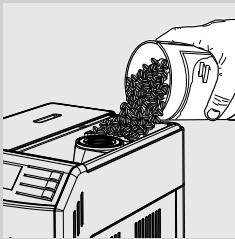

8 Slowly pour the coffee beans into the coffee bean hopper.



Note:

Do not pour too many coffee beans into the coffee bean hopper as this will reduce the grinding performance of the machine.



Caution:

Only coffee beans must be put into the coffee bean hopper. Ground coffee, instant coffee, flavored coffee or any other object may damage the machine.

9 Put back the coffee bean hopper lid on the coffee bean hopper.

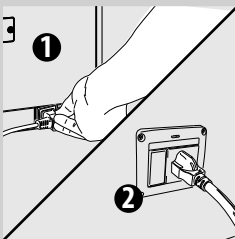

10 Insert the plug into the socket located on the back of the machine.

11 Insert the plug at the other end of the power cord into a wall socket with suitable power voltage.

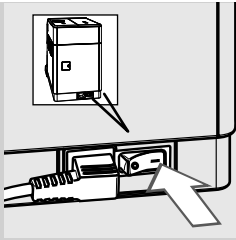

12 Switch the power button to "I" to turn on the machine. The "⏻" button flashes.

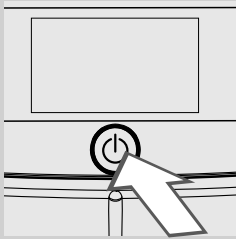

13 To turn on the machine simply press the "⏻" button. The control panel indicates that the circuit must be primed.



USING THE MACHINE FOR THE FIRST TIME

When using the machine for the first time, the following activities need to happen:

- 1) You need to prime the circuit.
- 2) The machine will perform an automatic rinse/self-cleaning cycle.
- 3) You need to initiate a manual rinse cycle.

Circuit Priming

During this process fresh water flows through the internal circuit of the machine and the machine warms up. This takes a few minutes.

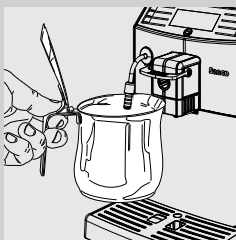

1 Place a container under the steam wand.

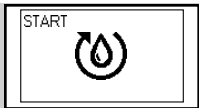

Yellow

- Press the “☺” button to start the cycle. The machine starts the automatic priming of the circuit by dispensing some water through the steam wand.



- The bar under the icon shows the operation progress. When the process is completed, the machine stops dispensing automatically.



Yellow

- Then the control panel shows the machine warm-up icon.

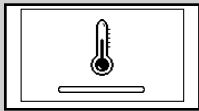

Yellow

Automatic Rinse/Self-Cleaning Cycle

When warm-up is complete, the machine automatically performs a rinse/self-cleaning cycle of the internal circuit with fresh water. This takes less than a minute.

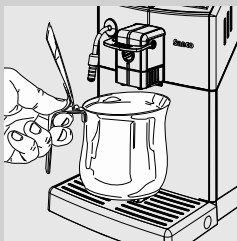

- Place a container under the dispensing spout to catch the small amount of water which will be dispensed.



Yellow

- The machine shows this display. Wait for the cycle to finish automatically.



Note:

You can stop dispensing by pressing the “☺” button.

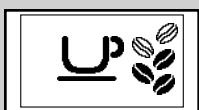

Green

- When the above steps are complete, the machine shows this display. You can now perform the manual rinse cycle.

Manual Rinse Cycle

During this process you activate the coffee brewing cycle and fresh water flows through the water circuit. This takes a few minutes.



- 1 Place a container under the dispensing spout.

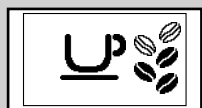

Green

- 2 Check that the machine shows this display.

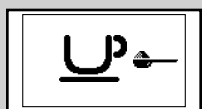

Green

- 3 Select the pre-ground coffee brewing function by pressing the “☕” button. The machine shows this display.



Note:

Do not add pre-ground coffee to the compartment.



- 4 Check that the selection lever is set to “ESPRESSO”. Press the “☕” button. The machine starts dispensing water.

- 5 When the dispensing has finished, empty the container. Repeat the operations from step 1 to step 4 twice, then continue with step 6.

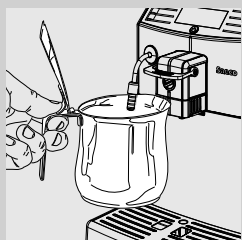

- 6 Place a container under the steam wand.

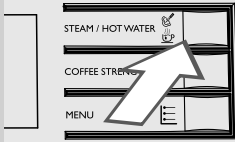

7 Press the “☞☕” button. The machine shows this display.



8 Press the “☞☕” button to start dispensing hot water.

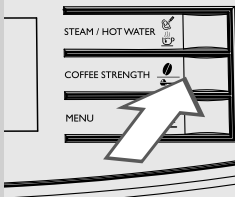

9 Dispense water until the no water icon appears.



Note:

You can interrupt the manual rinsing by pressing the “☞☕” button. To restart press the “☞☕” button and then the “☞☕” button.

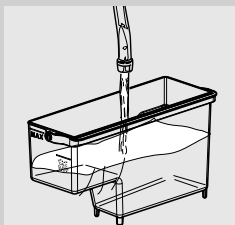

10 Fill the water tank again up to the MAX level. Now the machine is ready for coffee brewing.
The display to the left will be shown.



Note:

When the machine has not been operated for at least two weeks, it will automatically perform a start-up rinse/self-cleaning cycle. Following this, you need to initiate a manual rinse cycle as described above.

The automatic rinse/self-cleaning cycle starts automatically when the machine has been in stand-by mode or switched off for more than 15 minutes. At the end of the cycle, it is possible to brew a coffee.

Measuring and Programming Water Hardness

Water hardness measuring is very important in order to define the descaling frequency and to install the "INTENZA+" water filter (for more detail on the water filter, see next chapter).

To measure the water hardness follow the steps below:

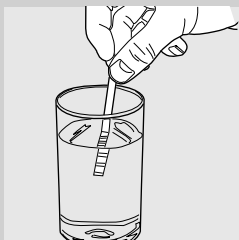

- 1 Immerse the water hardness test strip (supplied with the machine) in water for 1 second.



Note:

The test strip can only be used for one single measurement.

- 2 Wait for one minute.

- 3 Check how many squares have changed to the color red and then refer to the table.



Note:

The numbers on the water hardness test strip correspond to the water hardness adjustment settings.

More precisely:

1 = 1 (very soft water)

2 = 2 (soft water)

3 = 3 (hard water)

4 = 4 (very hard water)

The letters correspond to the references that are located at the base of the "INTENZA+" water filter (see next chapter).

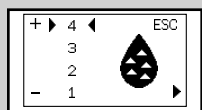
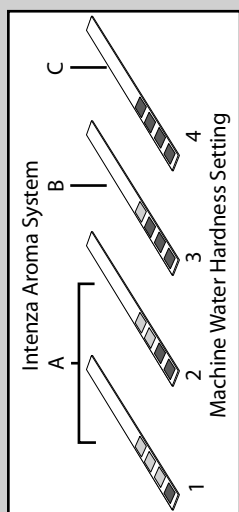

Yellow

- 4 Press the "ESC" button and scroll the pages by pressing the "4" button until the following icon is displayed.



Note:

The machine is supplied with a standard water hardness setting, suitable for most types of water.

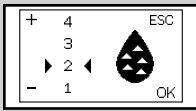

Yellow

5 Press the “☕” button to increase the value or the “☕” button to decrease the value.

6 Press the “☰” button to confirm the setting.



Green

7 Press the “☕☕” button to exit the programming MENU. The machine shows this display and is ready to brew.

“INTENZA+” Water Filter Installation

We recommend that you install the “INTENZA+” water filter as this prevents limescale build-up in your machine and preserves a more intense aroma of your coffee.



The “INTENZA+” water filter can be purchased separately. For further details, please refer to the maintenance products page in this manual. Water is a crucial part of every espresso/coffee, so it’s important to always have it professionally filtered. Using the “INTENZA+” water filter will prevent mineral deposits from building up and improve your water quality.

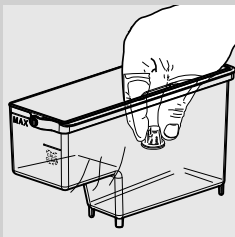

1 Remove the small white filter from the water tank and store it in a dry place.

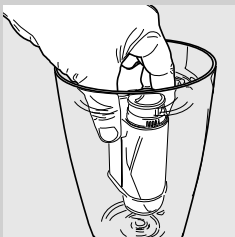

2 Remove the “INTENZA+” water filter from its packaging, immerse it vertically (with the opening positioned upwards) in cold water and gently press the sides so as to let the air bubbles out.

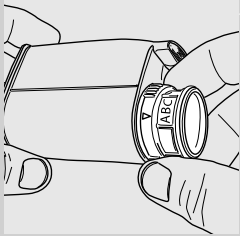

- 3** Set the "INTENZA+" water filter according to the measurements performed (see previous chapter) and indicated on the base of the filter:
 A = soft water – equals 1 or 2 on the test strip
 B = hard water (standard) – equals 3 on the test strip
 C = very hard water – equals 4 on the test strip

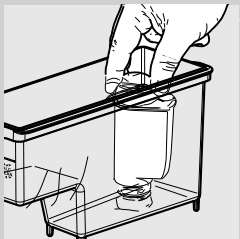

- 4** Put the "INTENZA+" water filter into the empty water tank. Press it down until it cannot move any further.

- 5** Fill the water tank with fresh water and reinsert it into the machine.

- 6** Dispense all the water of the tank by using the hot water function (see "Hot Water Dispensing" chapter).

- 7** Fill the water tank again.

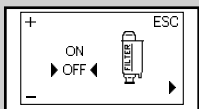

Yellow

- 8** Press the "☰" button and scroll the pages by pressing the "☰" button until the following display is shown.

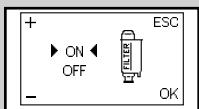

Yellow

- 9** Press the "☕" button to select "ON" and press the "☰" button to confirm.



Green

- 10** To exit, press the "☕" button. The machine shows this display and is ready to brew.

The machine has been programmed to inform the user when to replace the "INTENZA+" water filter.

Replacing the "INTENZA+" Water Filter

When the "INTENZA+" water filter needs to be replaced with a new one, the following icon is displayed.



Yellow

- 1 Replace the "INTENZA+" water filter as described in the previous chapter.

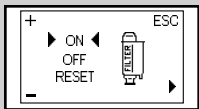

Yellow

- 2 Press the "≡" button and scroll the pages by pressing the "≡" button until the following icon is displayed.

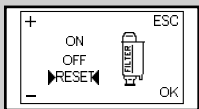

Yellow

- 3 Select the "RESET" option. Press the "≡" button to confirm.



Green

- 4 To exit, press the "☕" button. The machine shows this display and is ready to brew.

The machine is now programmed to manage a new "INTENZA+" water filter.

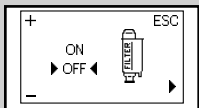

Yellow

- Note:**
If the "INTENZA+" water filter is already installed and you want to remove, but not replace it, select the "OFF" option instead.

If there is no "INTENZA+" water filter installed, insert the small white filter previously removed back into the water tank.

ADJUSTMENTS

The machine allows for certain adjustments so that you can brew the best tasting coffee possible.

Saeco Adapting System

Coffee is a natural product and its characteristics may change according to its origin, blend and roast. The machine is equipped with a self-adjusting system that allows the use of all types of coffee beans available on the market except for flavored coffee beans.

The machine automatically adjusts itself after brewing several cups of coffee to optimize the extraction of the coffee to the compactness of the ground coffee.

Adjusting the Ceramic Coffee Grinder

Ceramic coffee grinders always guarantee accurate and perfect grinding and coarseness for every coffee speciality.

This technology provides for full aroma preservation, delivering the truly Italian taste in every cup.



Warning:

The ceramic coffee grinder contains moving parts that may be dangerous. Do not insert fingers or other objects. Only adjust the ceramic coffee grinder using the grinder adjustment key.

The grinders can be set to adjust the grinding to your personal taste.

Adjusting the Dispensing Spout

The height of the dispensing spout can be adjusted to better fit the dimensions of the cups that you wish to use. The lower part of the dispensing spout can be removed to allow a tumbler to be used.

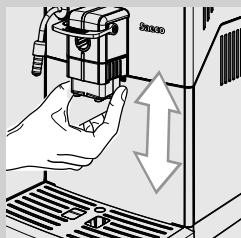

Move the dispensing spout up or down with your fingers to adjust its height as shown in the image.



The recommended positions are:
For the use of small cups;



For the use of large cups.

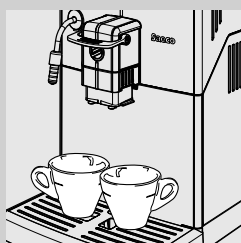

Two cups can also be placed under the dispensing spout to brew two cups of espresso at the same time.

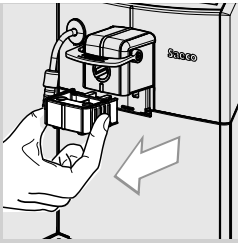

Remove the lower part of the dispensing spout to allow a tumbler to be used.

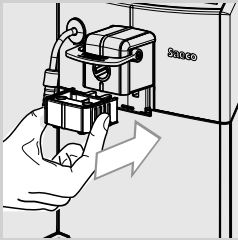
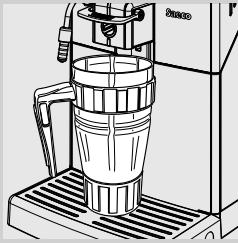

Note:

Before installing the lower part of the dispensing spout, clean it together with the upper part.

“ESPRESSO” or “COFFEE” selection lever

The machine allows you to adjust the brewing pressure according to the desired beverage type.

This selection allows you to optimize machine operation to improve the quality of coffee brewing and the desired result in the cup.

This selection must be made prior to brewing a beverage by simply moving manually the lever positioned on the dispensing spout.

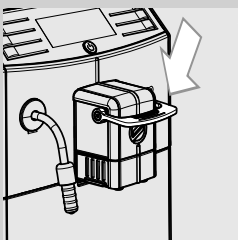



Red

The lever allows two types of brewing:

- 1 Push the lever downwards to select the "ESPRESSO" function.

In this position you can brew an espresso coffee by pressing the "☕" button.



Note:

If an espresso coffee is selected with the lever in the wrong position, the following icon will be displayed reminding you to set the lever to the correct position.

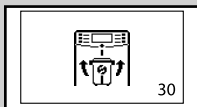

Red

- 2 Push the lever upwards to select the "COFFEE" function.

In this position you can brew a medium or long coffee by pressing the "☕" button or the "☕" button.



Note:

If a "COFFEE" product is selected with the lever in the wrong position, the following icon will be displayed reminding you to set the lever to the correct position.

Adjusting the Beverage Cup Length

The machine allows you to adjust the amount of brewed coffee according to your taste and the size of your cups. Each time the “☺”, “☹” or “☹☺” button is pressed, the machine brews a pre-set amount of beverage. Each button may be individually programmed for a specific brew setting.

The following procedure describes how to program the “☺” button.

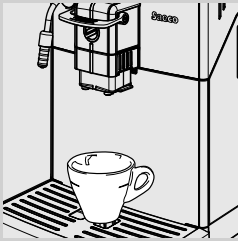

1 Place a cup under the dispensing spout.

2 Check the position of the selection lever.



Green

3 Press and hold the “☺” button until the “MEMO” icon appears on the display, then release the button. The machine has now entered programming mode. The machine starts brewing coffee.



Green

4 Press the “☺” button as soon as the desired amount of coffee is reached.

Now the “☺” button is programmed; each time it is pressed, the machine will brew the same amount of espresso that was just programmed.

Note:

To program the other two “☹” or “☹☺” beverages, the same steps should be followed. You should always use the “☺” button to stop brewing coffee when the desired amount of coffee is reached even when you are programming the other two “☹” or “☹☺” beverages.

BREWING AN "ESPRESSO".

Before brewing an espresso coffee, make sure that there are no warnings shown on the control panel, and that the water tank and coffee bean hopper are filled.

Brewing an Espresso using Coffee Beans

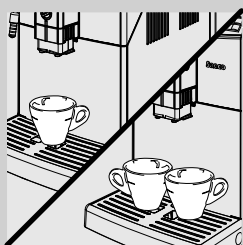

- 1 Place 1 or 2 cups under the dispensing spout.



- 2 Push the lever downwards to select the "ESPRESSO" function.



Green

- 3 To brew an espresso, press the "☕" button to select the desired aroma.

- 4 To brew an espresso, press the "☕" button once. This icon will be displayed.



Green

- 5 To brew two espressos, press the "☕" button twice consecutively. This icon will be displayed.



Note:

In this operating mode, the machine automatically grinds and doses the correct amount of coffee. Brewing two espressos requires two grinding and brewing cycles, automatically carried out by the machine.

- 6 After the prebrewing cycle, the beverage begins to pour out of the dispensing spout.
- 7 Espresso brewing automatically stops when the preset level is reached; press the “☕” button to stop it earlier.

Brewing an Espresso using Pre-Ground Coffee

This function allows you to use pre-ground coffee.

With the pre-ground coffee function you can only brew one beverage at a time.



- 1 Push the lever downwards to select the “ESPRESSO” function.

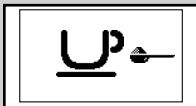

- 2 Press the “☕” button until the display shows the icon for pre-ground coffee.

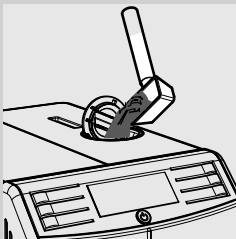

- 3 Lift the pre-ground coffee compartment lid and add one scoop of pre-ground coffee to the compartment. Use only the measuring scoop supplied with the machine. Then close the pre-ground coffee compartment lid.



Warning:

Add only pre-ground coffee to the pre-ground coffee compartment. Other substances and objects may cause severe damage to the machine. Such damage will not be covered by warranty.

4 Press the “☕” button to brew an espresso. The brewing cycle starts.

5 After the prebrewing cycle, the beverage begins to pour out of the dispensing spout.

6 Brewing automatically stops when the preset level is reached; press the “☕” button to stop it earlier.

After brewing, the machine returns to the main menu.

Repeat the steps described above to brew more espressos using pre-ground coffee.



Note:

If no pre-ground coffee is poured into the pre-ground coffee compartment, only water will be dispensed.

If the dose is excessive and 2 or more scoops of pre-ground coffee are used, the machine will not brew the product and any ground coffee will be discharged into the coffee grounds drawer.

BREWING A COFFEE

Before brewing coffee, make sure that there are no warnings shown on the control panel, and that the water tank and coffee bean hopper are filled.

Brewing a Coffee Using Coffee Beans

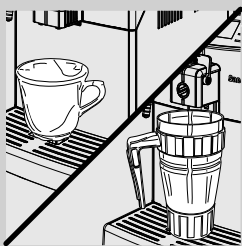

1 Place 1 MUG or 1 TUMBLER under the dispensing spout.



Note:

Refer to section “Adjusting the Dispensing Spout” for the “Tumbler” positioning.



2 Push the lever upwards to select the “COFFEE” function.

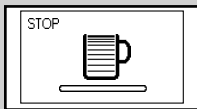

Green

3 To brew a beverage, press the “☉” button to select the desired aroma.

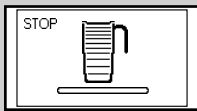

Green

4 To brew a medium coffee, press the “☉” button once. This icon will be displayed.

5 To brew a long coffee, press the “☉” button once. This icon will be displayed.



Note:

In this operating mode, the machine automatically grinds and doses the correct amount of coffee.

6 After the prebrewing cycle, the beverage begins to pour out of the dispensing spout.

7 Beverage brewing automatically stops when the preset level is reached; press the “☉” button to stop it earlier.

Brewing a coffee Using Pre-Ground Coffee

This function allows you to use pre-ground coffee.

With the pre-ground coffee function you can only brew one beverage at a time.



1 Push the lever upwards to select the “COFFEE” function.

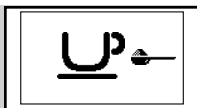

Green



2 Press the “☕” button to select the pre-ground coffee function.

3 Lift the pre-ground coffee compartment lid and add one measuring scoop of pre-ground coffee to the compartment. Use only the measuring scoop supplied with the machine. Then close the pre-ground coffee compartment lid.

**Warning:**

Add only pre-ground coffee to the pre-ground coffee compartment. Other substances and objects may cause severe damage to the machine. Such damage will not be covered by warranty.

4 Press the “☕” button for a medium coffee or the “☕” button for a long coffee. The brewing cycle starts.

5 After the prebrewing cycle, coffee begins to pour out of the dispensing spout.

6 Coffee brewing automatically stops when the preset level is reached; press the “☕” button to stop it earlier.

After brewing, the machine returns to the main menu.

Repeat the steps described above to brew more coffees using pre-ground coffee.

**Note:**

If no pre-ground coffee is poured into the pre-ground coffee compartment, only water will be dispensed.

If more scoops have been added, the machine will not brew the product and the ground coffee in the compartment will be discharged into the coffee grounds drawer.

DISPENSING STEAM/CAPPUCCINO BREWING

**Warning:**

Danger of scalding! Dispensing may be preceded by small jets of hot water. The Automatic Milk Frother may reach high temperatures. Never touch it with bare hands. Use the appropriate protective handle only.

- 1 Fill 1/3 of a container with cold milk.

**Note:**

To make a good quality cappuccino, use cold milk (~5°C / 41°F) with a protein content of at least 3%. Whole milk or skimmed milk may be used depending on individual taste.

**Note:**

When you plan to dispense steam right after switching on the machine or after brewing a coffee, some water still present in the circuit may need to be dispensed first. For this press the “☕” button and then the “☕” button to dispense steam for a few seconds. Thereafter press the “☕” button to stop. Continue with step 2.

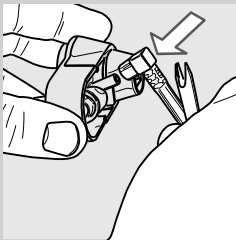

- 2 Insert the suction tube into the Automatic Milk Frother.

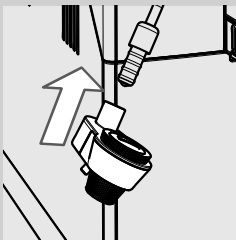

- 3 Insert the Automatic Milk Frother until it locks in place in the steam wand seat.

**Caution:**

Make sure that the suction tube outer surface is clean for hygienic reasons.

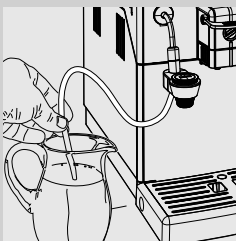

- 4 Plunge the suction tube in the milk container.

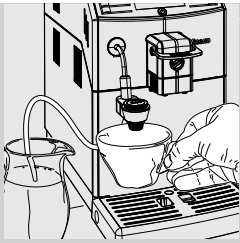

5 Place a cup under the Automatic Milk Frother.

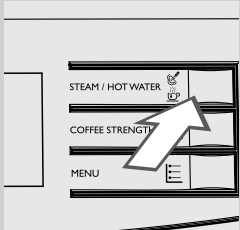

6 Press the “☕” button. The machine shows this display.



Red

7 Press the “☕” button to start dispensing steam.



Note:

Steam dispensing automatically stops after a continued use of 3 minutes. Press the “☕” button then the “☕” button to start dispensing steam again.

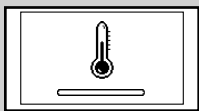

Yellow

8 The following icon is displayed during pre-heating time required by the machine.



Green

9 When this icon is displayed, the machine dispenses frothed milk directly in the cup.

10 Press the “☕” button to stop brewing.

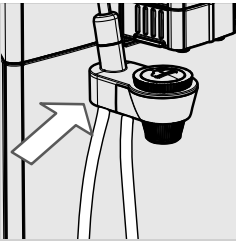

11 For storage you can put the suction tube as shown in the picture.



Note:

After having pressed the “☕” button it will take a few seconds before the machine stops dispensing steam completely.



Caution:

After frothing the milk, a small quantity of hot water must be dispensed into a container. See chapter "Daily cleaning of the Automatic Milk Frother" for detailed cleaning instructions.



Green



Note:

After frothing the milk, it is possible to brew an espresso or dispense hot water straight after.

HOT WATER DISPENSING



Warning:

Danger of scalding! Dispensing may be preceded by small jets of hot water. The Automatic Milk Frother may reach high temperatures. Never touch it with bare hands. Use the appropriate protective handle only.

Before dispensing hot water, make sure that the machine is ready to use and the water tank is filled.

1

Place a container under the steam wand.

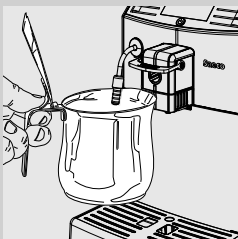

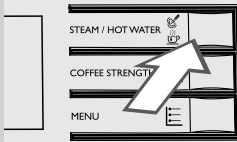

2 Press the “☕” button. The machine shows this display.



3 Press the “☕” button to start dispensing hot water.

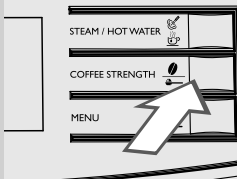

4 The following icon is displayed during pre-heating time required by the machine.

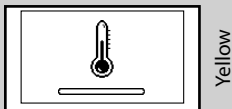

5 Pour the desired amount of hot water. To stop the hot water dispensing, press the “☕” button.



CLEANING AND MAINTENANCE

Daily Cleaning of the Machine



Caution:

Timely cleaning and maintenance of your machine is very important as it prolongs the life of your machine. Your machine is continuously exposed to moisture, coffee and limescale!

The activities you need to perform and their frequency are described in detail in this chapter. Not doing this will ultimately make your machine stop working properly. This repair is NOT covered by your warranty!



Note:

- Use a soft, dampened cloth to clean the machine.
- Only the cup holder grill and the Automatic Milk Frother can be washed in the dishwasher. All other components must be washed with lukewarm water.
- Do not immerse the machine in water.
- Do not use alcohol, solvents, and/or abrasive objects to clean the machine.
- Do not dry the machine and/or its components using a microwave and/or standard oven.

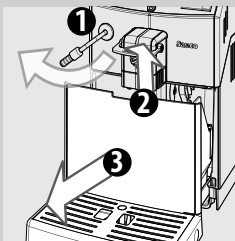

- 1** Empty and clean the coffee grounds drawer and the drip tray daily with the machine turned on.

Other maintenance operations can only be carried out when the machine is turned off and unplugged.

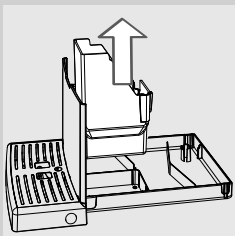

- 2** Remove the coffee grounds drawer and empty it.
- 3** Empty and clean the drip tray.

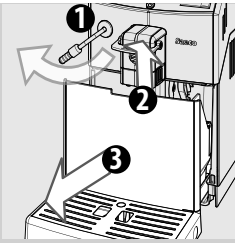

- 4 Insert the coffee grounds drawer back into the drip tray and this into the machine.

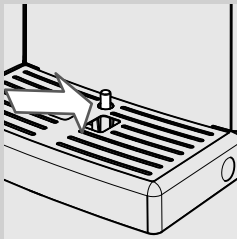

- Note:**
Also empty the drip tray when the full drip tray indicator is raised.

Daily Cleaning of the Water Tank

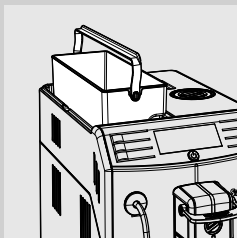

- 1 Remove the small white filter or the "INTENZA+" water filter (if installed) from the water tank and wash it with fresh water.
- 2 Put the small white filter or the "INTENZA+" water filter (if installed) back in its housing by gently pressing and turning it at the same time.
- 3 Fill the water tank with fresh water.

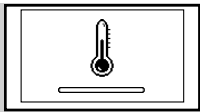

Yellow

4 Press the “☕” button to start dispensing steam.

5 This icon is displayed during pre-heating time required by the machine.



Green

6 The following icon will be displayed during the dispensing phase. Dispense water from the Automatic Milk Frother until clear water flows out. Press the “☕” button to stop dispensing.

7 Clean the suction tube with a damp cloth.

Weekly Cleaning of the Machine

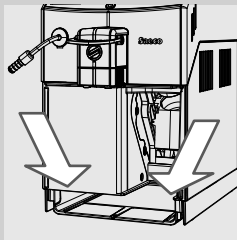

1 Clean the seat of the drip tray.

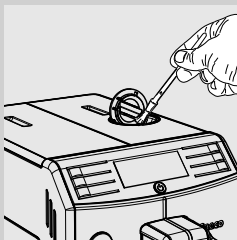

2 Clean the pre-ground coffee compartment with the cleaning brush.

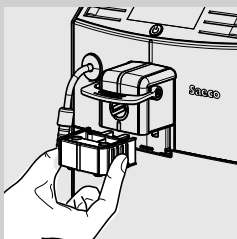

3 Remove the lower part of the dispensing spout and wash it with lukewarm water.

Weekly Cleaning of the Brew Group

The brew group should be cleaned every time the coffee bean hopper is filled or at least once a week.

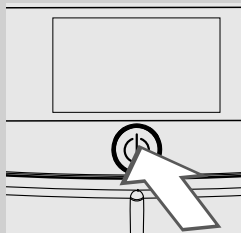

- 1 Turn off the machine by pressing the "⏻" button and unplug the power cord.

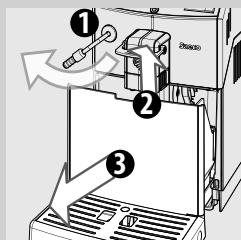

- 2 Remove the drip tray and coffee grounds drawer. Only at this time open the service door.

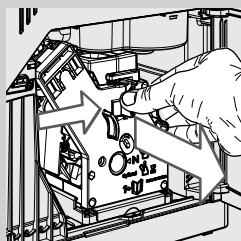

- 3 To remove the brew group, press the «PUSH» button pulling it by the handle and pull it out horizontally without turning it.

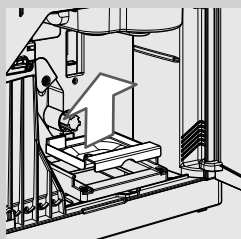

- 4 Remove the coffee residues drawer and wash it thoroughly.

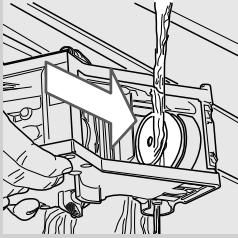

5 Thoroughly wash the brew group with fresh, lukewarm water and carefully clean the upper filter.

! **Caution:**

Do not use detergent or soap to clean the brew group.

6 Let the brew group air-dry thoroughly.

7 Thoroughly clean the inside of the machine using a soft, dampened cloth.

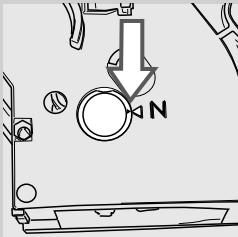

8 Make sure the brew group is in the rest position; the two reference signs must match. If they do not match up, proceed as described in steps 9-10.

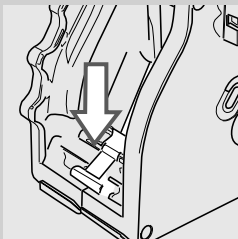

9 Gently pull down the lever until it is in contact with the brew group base and the two reference signs on the side of the brew group match.

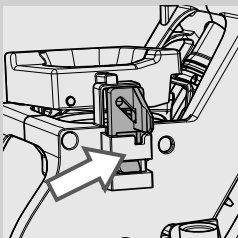

10 Make sure the hook to lock the brew group is in the correct position by firmly pressing the "PUSH" button until it locks into place. Check if the hook is at the top end position. If it is not, please try again.

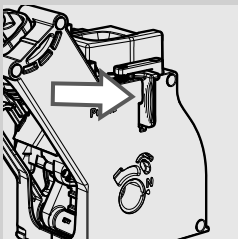

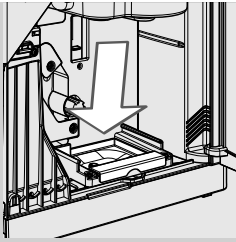

- 11** Insert the coffee residues drawer in its seat and ensure that it is correctly in place.



Note:

If the coffee residues drawer is not correctly positioned, the brew group may not fit into the machine.

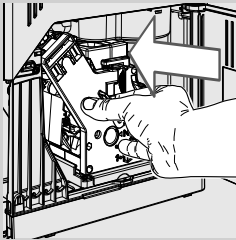

- 12** Insert the brew group in its seat again until it locks into place without pressing the "PUSH" button.

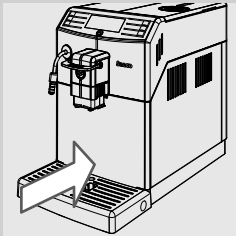

- 13** Insert the coffee grounds drawer with the drip tray back into the machine and close the service door.

Monthly Cleaning of the Automatic Milk Frother

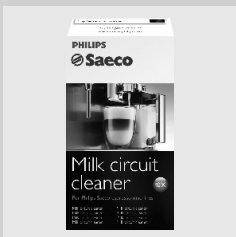

Every month you need to perform a more thorough cleaning of the Automatic Milk Frother using the "Saeco Milk Circuit Cleaner". The "Saeco Milk Circuit Cleaner" can be purchased separately. Please refer to the maintenance product page in this user manual for further details.



Warning:

Danger of scalding! Dispensing may be preceded by small jets of hot water.



Green

- 8** The following icon will be displayed during dispensing. When the solution has been completely dispensed, press the “☕” button to stop dispensing.



Note:

Steam dispensing automatically stops after a continued use of 3 minutes. Press the “☕☕” button then the “☕” button to start dispensing steam again.



Warning:

Never drink the solution dispensed during this step.

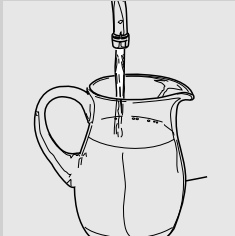

- 9** Rinse the container thoroughly and fill it with 17 ounces of fresh water to be used for the rinse cycle.

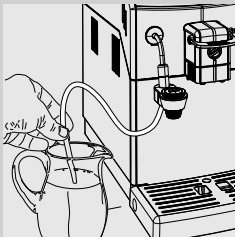

- 10** Insert the suction tube into the container.

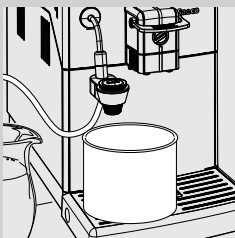

- 11** Empty the container and place it back under the Automatic Milk Frother.

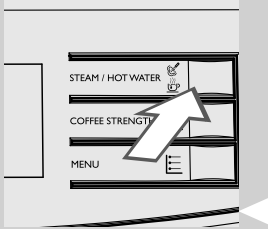

Red

12 Press the “☞☕” button. The machine shows this display.

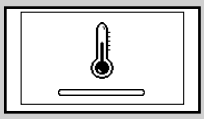

Yellow

13 Press the “☞” button to start dispensing steam.

14 This icon is displayed during pre-heating time required by the machine.



Green

15 The following icon will be displayed during dispensing. When the solution has been completely dispensed, press the “☞☕” button to stop dispensing.

Note:

Steam dispensing stops after 3 minutes. Press the “☞☕” button then the “☞” button to start dispensing steam again.

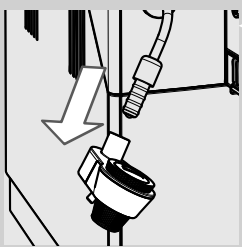

16 Wash all the Automatic Milk Frother components by following the instructions below.

17 Remove the Automatic Milk Frother from the machine.

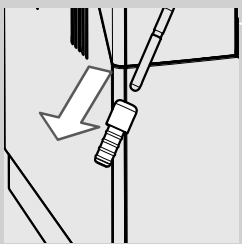

18 Remove the rubber grip from the steam wand.

Caution:

Warning: The tube could be hot if the machine has recently been used.

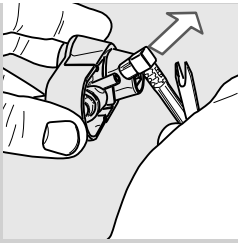

19 Take off the suction tube.

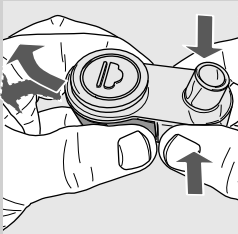

20 To detach the Automatic Milk Frother, press the sides and remove it by applying light lateral movements as shown in the figure.

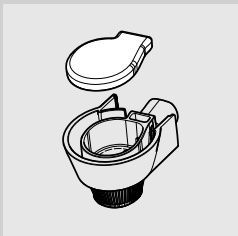

21 Remove the rubber lid as shown in the figure.



22 Wash all the components with lukewarm water.

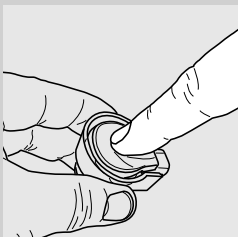

23 Attach the lid by pressing in the middle, and ensure that it is firmly in place.

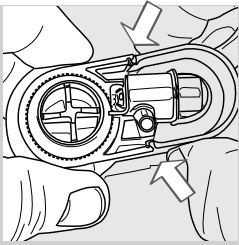

24 Attach the Automatic Milk Frother to the fitting and ensure it is locked into place in its seat.

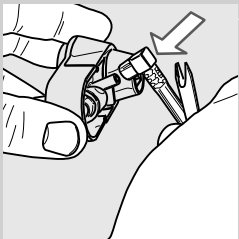

25 Install the suction tube.

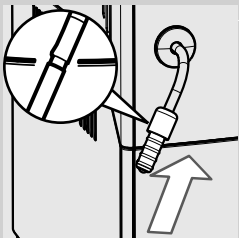

26 Insert the rubber grip back on the steam wand.



Caution:

Warning: The tube could be hot if the machine has recently been used.



Caution:

Do not insert the rubber grip further than the seat shown. In this case, the Automatic Milk Frother would not function correctly as it would not be able to draw up milk.

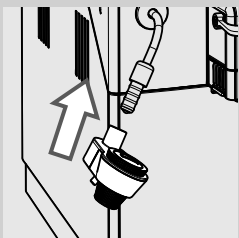

27 Insert the Automatic Milk Frother on the rubber grip until it locks into place.

Monthly Lubrication of the Brew Group

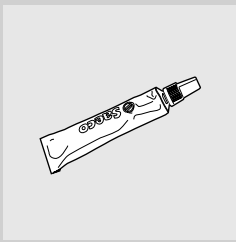

Lubricate the brew group after approximately 500 cups of coffee or once a month.

The grease to lubricate the brew group can be purchased separately. For further details, please refer to the maintenance products page in this manual.



Caution:

Before lubricating the brew group, clean it with fresh water and let it dry, as described in the “Weekly Cleaning of the Brew Group” chapter.

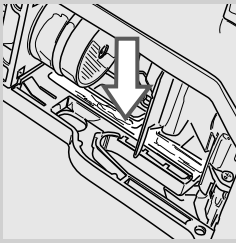

- 1 Apply the grease evenly on both side guides.

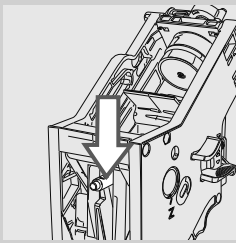
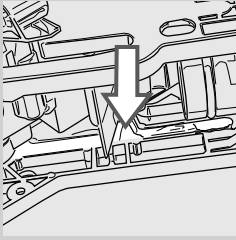

- 2 Also lubricate the shaft.

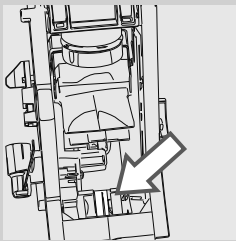

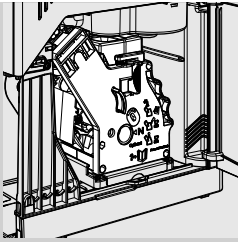

3 Insert the brew group in its seat until it locks into place (see “Weekly Cleaning of the Brew Group” chapter).

4 Close the service door and insert the drip tray and coffee grounds drawer.

Monthly Cleaning of the Brew Group with “Coffee Oil Remover”



Besides weekly cleaning, we recommend running the cleaning cycle with “Coffee Oil Remover” after approximately 500 cups of coffee or once a month. This operation completes the maintenance process for the brew group.

You can purchase separately the “Coffee Oil Remover”. For further details, please refer to the maintenance products page in this manual.



Caution:

The “Coffee Oil Remover” tablets are to be used for cleaning only and do not have a descaling function. For the descaling procedure use the Saeco descaling solution and follow the procedure described in the “Descaling” chapter.



1 Place a container under the dispensing spout.

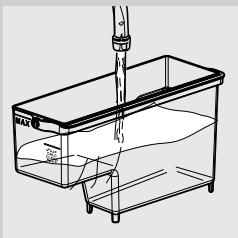

2 Make sure the water tank is filled with fresh water up to the “MAX” level.

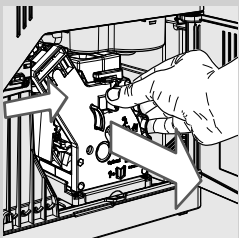
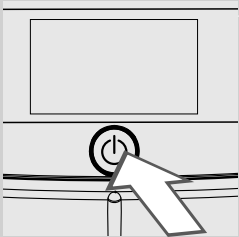
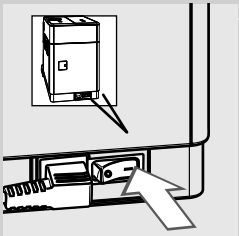
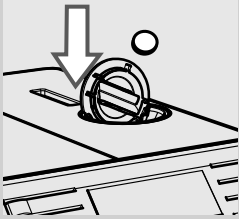

3 Put a "Coffee Oil Remover" tablet in the pre-ground coffee compartment.

4 Press the "☕" button to select the pre-ground coffee function without adding pre-ground coffee to the compartment.

5 Push the lever downwards to select the "ESPRESSO" function.

6 Press the "☕" button to start the brewing cycle.

7 Wait until the machine has dispensed half a cup of water.

8 Switch the power button on the back of the machine to "0".

9 Let the solution take effect for about 15 minutes. Make sure you discard the dispensed water.

10 Switch the power button on the back of the machine, to "I". To turn on the machine, press the "⏻" button. Wait until the end of the automatic rinse cycle.

11 Remove the drip tray and the coffee grounds drawer and open the service door. Remove the brew group.

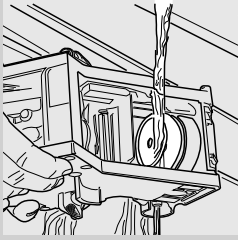

12 Wash the brew group thoroughly with fresh water.

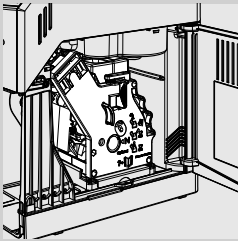

13 After rinsing the brew group, insert it again in its seat until it locks into place (see “Weekly Cleaning of the Brew Group” chapter). Insert the drip tray and the coffee grounds drawer. Close the service door.

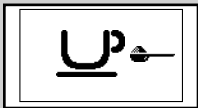

Green

14 Press the “☕” button to select the pre-ground coffee function without adding pre-ground coffee to the compartment.

15 Press the “☕” button to start the brewing cycle.

16 Repeat steps 14 to 15 twice. Make sure you discard the dispensed water.

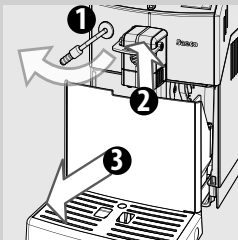

17 To clean the drip tray, place “Coffee Oil Remover” tablet inside and fill it 2/3rds full with hot water. Let the cleaning solution take effect for about 30 minutes, then rinse thoroughly.

Monthly Cleaning of the Coffee Bean Hopper

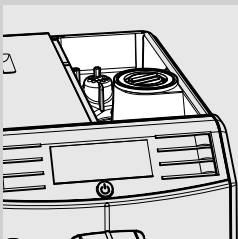

Clean the coffee bean hopper once a month when it is empty with a damp cloth to remove coffee oil. Thereafter refill it with coffee beans.

DESCALING

The descaling process takes approx. 35 minutes.



Yellow

Limescale builds up inside the machine during use. It needs to be removed regularly as it may clog the water and coffee circuit of your machine. The machine tells you when descaling is needed. If the machine display shows the **CALC CLEAN** icon, it means that you need to descale it.



Caution:

Not doing this will ultimately make your machine stop working properly, and in this case repair is NOT covered by your warranty.



Always use the specially formulated descaling solution, since it has been designed to optimize machine performance.

The descaling solution can be purchased separately. For further details, please refer to the maintenance products page in this manual.



Warning:

Never drink the descaling solution or any products dispensed until the cycle has been carried out to the end. Never use vinegar as a descaling solution.



Note:

During the descaling cycle do not switch off the machine. If the machine has been switched off, it will continue the descaling from the point at which it was interrupted the next time it is turned on.

To execute the descaling cycle, follow the steps below:

Before descaling:

- 1 Empty the drip tray and the coffee grounds drawer.

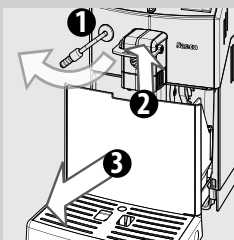

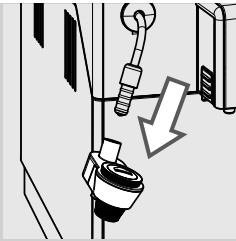

2 Remove the Automatic Milk Frother from the steam/hot water wand.

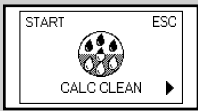

Yellow

3 Remove the "INTENZA+" water filter from the water tank if it was installed and replace it with the small white original one. Place the water tank back into the machine.

4 Press the "☰" button until the following display is shown.

5 Press the "☺" button to start the descaling process.

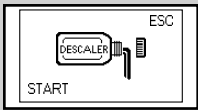

Yellow

Note:

If you press the "☺" button by mistake, press the "☺☺" button to quit.

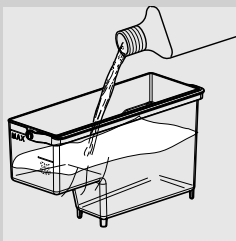

6 Remove the water tank and pour in the entire contents of the descaling solution. Then top up the tank with fresh water up to the calc clean level.

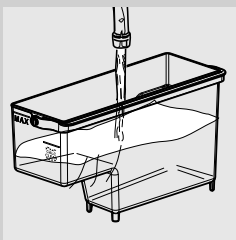

7 Place the water tank back into the machine.

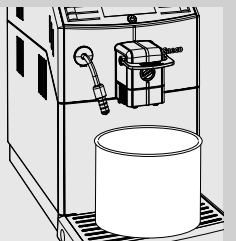

8 Place a large container (1.5 l) under both the steam/hot water wand and the dispensing spout.

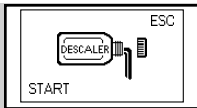

Yellow

9 Press the “” button to start the descaling cycle.

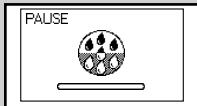



Yellow

10 The machine will start dispensing the descaling solution at regular intervals. The bar on the control panel shows the cycle progress.



Note:

The descaling cycle may be paused by pressing the “” button. To resume the cycle, press the “” button again. This allows you to empty the container or to stay away from the machine for a brief period of time.

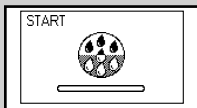

Yellow



Red

11 When this icon is displayed, the water tank is empty.

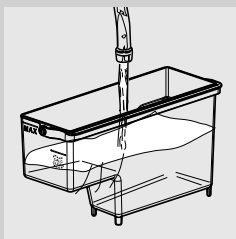

12 Remove the water tank, rinse it and fill it up to the MAX level with fresh water. Place it back into the machine. When inserting the water tank into the machine, the following display is shown.

13 Empty the drip tray and coffee grounds drawer and place them back in position.

14 Empty the container back and place it back under both the steam/hot water wand and the dispensing spout.



Yellow

15 Press the “” button to start the rinse cycle.



Red

16 When this icon is displayed, the water tank is empty. Repeat steps 12-15. When the machine shows this icon again, go to step 17.

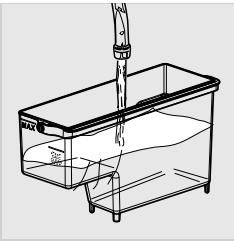

17 When the water tank is empty, remove the water tank, rinse it and fill it up to the MAX level with fresh water. Place it back into the machine.



Green

18 Empty the container back and place it back under both the steam/hot water wand and the dispensing spout.

19 When the amount of water needed for the rinse cycle has been completely dispensed, this icon on the side is displayed. Press the “☕” button to quit the descaling cycle.

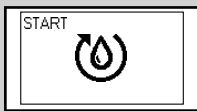

Yellow

20 Press the “☕” button to prime the circuit.

21 The machine now carries out the warm-up and automatic rinse cycle to prepare for product brewing.

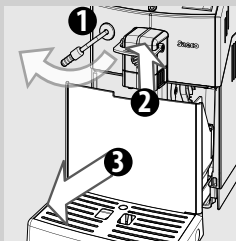

22 Remove and empty the container.

23 Empty the drip tray and place it back.

24 The descaling cycle is now complete.

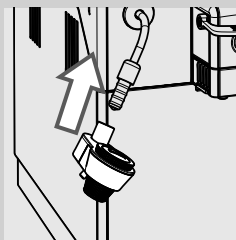

25 Remove the small white filter and replace the INTENZA+ water filter (if fitted) in the water tank. Reinsert the Automatic Milk Frother.



Note:

At the end of the descaling cycle, wash the brew group as described in the “Weekly cleaning of the brew group” chapter.

The rinse cycles are performed in order to have the circuit cleaned with a preset amount of water to ensure proper machine performance. If the water tank is not filled up to MAX level, the machine might require three or more cycles.

PROGRAMMING

It is possible to customise the machine's functions via the programming menu.

The following settings can be adjusted

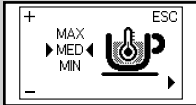

Yellow

Coffee temperature

This function adjusts the coffee brewing temperature.

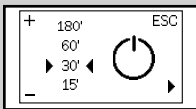

Yellow

Timer (stand-by)

This function adjusts the time taken for the machine to go into stand-by mode after the last brewing.

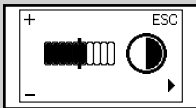

Yellow

Contrast

This function adjusts the contrast of the display to better view the messages.

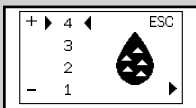

Yellow

Water hardness

This function adjusts the water hardness setting according to the area where you live.

- 1 = very soft water
- 2 = soft water
- 3 = hard water
- 4 = very hard water

For more details, please see the "Measuring and Programming Water Hardness" chapter.

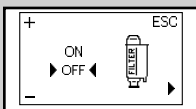

Yellow

"INTENZA+" Water Filter

This function manages the "INTENZA+" water filter. For more details, see the chapter about filter handling.

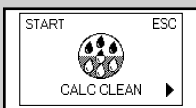

Yellow

Descaling cycle

This function activates the descaling cycle.



Yellow

Factory settings

This function allows you to reset all factory values.

How to Program the Machine

In this example, it is shown how to program the display contrast. Proceed in the same way to program the other functions.



Green

The programming menu can only be accessed when the machine is on and shows this display.

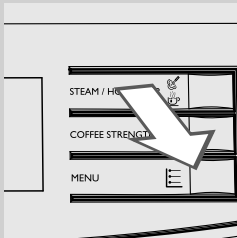

1 Press the "☰" button to access programming.

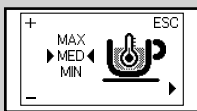

Yellow

2 The main screen will be displayed.

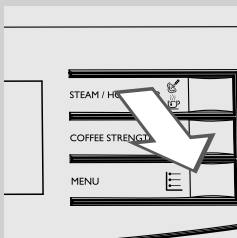

3 Press the "☰" button to scroll the pages until the display contrast function is displayed.

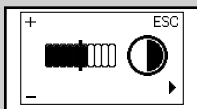

Yellow

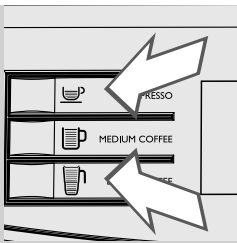

4 Press the “☕” and “☕” buttons to increase or decrease the value of the function.



5 When the display value is changed, the “OK” message appears. Press the “OK” button to confirm the change.

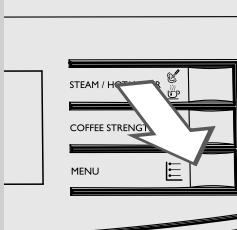

6 Press the “☕☕” button to exit the programming menu.

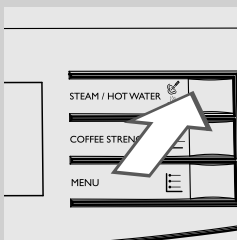

Note:

The machine automatically exits programming mode if no button is pressed for 3 minutes. The values that have been changed but not confirmed won't be saved.

MEANING OF THE DISPLAY ICONS

This machine is equipped with a color-coded system to make the user's understanding of the display signals easier. The icons are color-coded according to the traffic light principle.

Ready Signals (Green Color)

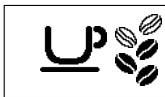

The machine is ready to brew products.

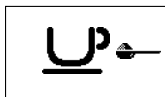

The machine is ready to brew pre-ground coffee.

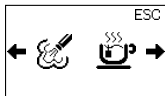

Steam or hot water selection.



Hot water dispensing.



Steam dispensing.

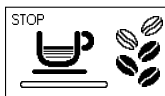

The machine is brewing one cup of espresso.

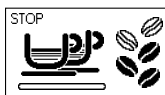

The machine is brewing two cups of espresso.



The machine is programming the amount of espresso to brew.

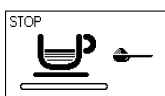

Espresso brewing using pre-ground coffee in progress.

Ready Signals (Green Color)

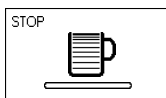

The machine is brewing one cup of medium coffee.

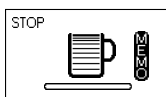

The machine is programming the amount of medium coffee to be brewed.

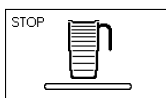

The machine is brewing one cup of long coffee.

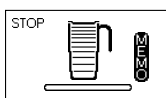

The machine is programming the amount of long coffee to be brewed.

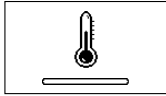
Warning Signals (Yellow Color)

The machine is in warm-up phase to brew beverages or dispense hot water/steam.



The machine is performing the rinse phase. Wait until the machine has completed the cycle.



The machine needs the "INTENZA+" water filter to be replaced.



The brew group is being reset due to machine reset.



Refill the coffee bean hopper with coffee beans. Put back the coffee bean hopper lid and restart the cycle.

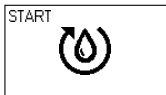

Prime the circuit.

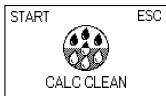

The machine needs to be descaled. Press the "☕" button to start the descaling process. Follow the steps described in the "Descaling" chapter of this manual.

If you want to descale later, press the "☕" button to continue using the machine.

Please note that not descaling your machine will ultimately make it stop working properly. In this case repair is NOT covered under your warranty.

Warning Signals (Red Color)



Completely insert the drip tray with the coffee grounds drawer into the machine and close the service door.

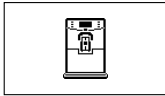

Fill the coffee bean hopper.



The brew group must be inserted into the machine.

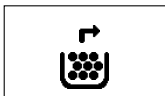

Empty the coffee grounds drawer. Wait about 5 seconds before placing it back.



Set the "ESPRESSO" or "COFFEE" selection lever to "ESPRESSO" within 30 seconds to complete brewing.



Set the "ESPRESSO" or "COFFEE" selection lever to "COFFEE" within 30 seconds to complete brewing.



Fill the water tank.

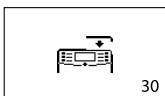

A beverage has been selected without the coffee bean hopper inner lid on the machine. Place the coffee bean hopper inner lid on the machine within 30 seconds to complete brewing.

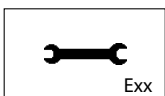



Turn off the machine. After 30 seconds, turn it on again. Try this 2 or 3 times. If the machine will not start, contact the Philips SAECO hotline in your country and quote the error code shown on the display. You can find its contact details in the warranty booklet packed separately or on www.philips.com/support.

TROUBLESHOOTING

This chapter summarizes the most common problems you could encounter with your machine.

If you are unable to solve the problem with the information below, visit www.philips.com/support for a list of frequently asked questions or contact the Philips Saeco hotline in your country.

The contact details can be found in the warranty booklet supplied separately or on www.philips.com/support.

Machine actions	Causes	Solutions
The machine does not switch on.	The machine is not connected to the electric network, or the power button is in the "O" position.	Connect the machine to the electric network and turn the power button to the "I" position.
The drip tray gets filled although no water is drained.	Sometimes water is drained automatically by the machine into the drip tray to manage the rinsing of the circuits and ensure optimum machine performance.	This is seen as normal machine behavior.
The red  icon is always displayed on the machine.	The coffee grounds drawer was emptied with the machine off.	The coffee grounds drawer must always be emptied with the machine on. Wait until the  icon is displayed before refitting the drawer.
The espresso is not hot enough.	The cups are cold.	Preheat the cups with hot water.
No hot water or steam is dispensed.	The hole of the hot water/steam wand is clogged.	Clean the hole of the steam wand using a pin. Make sure that the machine is off and has cooled down before performing this operation.
The espresso is not creamy enough (See note)	The blend is unsuitable, coffee is not freshly roasted or the grind is too coarse.	Change coffee blend or adjust the degree of grind as explained in the "Adjusting the Ceramic Coffee Grinder" chapter.
The machine takes a long time to warm up or the amount of water dispensed is too little.	The machine circuit is clogged by limescale.	Descale the machine.
The brew group cannot be removed.	The brew group is out of place.	Turn the machine on. Close the service door. The brew group automatically returns to the initial position.
	The coffee grounds drawer is inserted.	Remove the coffee grounds drawer before removing the brew group.

Machine actions	Causes	Solutions
The machine grinds the coffee beans but no coffee comes out. (See note)	There is no water.	Fill the water tank and prime the circuit (see "Using the Machine for the First Time" chapter).
	The brew group is dirty.	Clean the brew group (see "Weekly Cleaning of the Brew Group" chapter).
	The circuit is not primed.	Prime the circuit (see "Using the Machine for the First Time" chapter).
	This might occur when the machine is automatically adjusting the dose.	Brew a few cups of coffee as described in the "Saeco Adapting System" chapter.
	The dispensing spout is dirty.	Clean the dispensing spout.
The beverage is too weak. (See note)	This might occur when the machine is automatically adjusting the dose.	Brew a few cups of coffee as described in the "Saeco Adapting System" chapter.
The beverage is brewed slowly. (See note)	The coffee grind is too fine.	Change coffee blend or adjust the grind as explained in the "Adjusting the Ceramic Coffee Grinder" chapter.
	The circuit is not primed.	Prime the circuit (see "Using the Machine for the First Time" chapter).
	The brew group is dirty.	Clean the brew group (see "Weekly Cleaning of the Brew Group" chapter).
Coffee leaks out of the dispensing spout.	The dispensing spout is clogged.	Clean the dispensing spout and its holes.
Milk does not froth.	The Automatic Milk Frother is inserted too deep. No milk is being suctioned.	Leave the Automatic Milk Frother to cool down. Move it slightly downwards. Reposition it in its correct seat.
Frothed milk is too cold.	The cups are cold.	Preheat the cups with hot water.

**Note:**

* These problems can be considered normal if the coffee blend has been changed or if the machine has just been installed. In this case wait until the machine performs a self-adjusting operation as described in the "Saeco Adapting System" chapter.

ENERGY SAVING

Stand-by

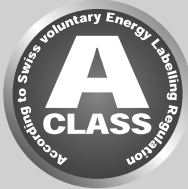

The Saeco full automatic espresso machine is designed for energy saving proven by the Class A energy label.

After 30 minutes of inactivity, the machine turns off automatically (unless a different stand-by time has been programmed). If a product has been brewed the machine performs a rinse cycle.

In stand-by mode, the energy consumption is below 1Wh. To turn on the machine, press the "⏻" button (if power button on the back of the machine is set to "I"). If the boiler is cold the machine performs a rinse cycle.

Disposal



Do not throw away the machine with the normal household waste at the end of its life, but hand it in at an official collection point for recycling. By doing this, you help to preserve the environment.

- The packing materials can be recycled.
- Machine: unplug the machine and cut the power cord.
- Deliver the appliance and power cord to a service centre or public waste disposal facility.

This product complies with EU Directive 2002/96/EC. The symbol on the product or on its packaging indicates that this product may not be treated as household waste. Instead, it must be handed over to the appropriate waste collection centre for the recycling of electrical and electronic equipment.

By ensuring this product is disposed of correctly, you will help prevent potential negative consequences for the environment and human health, which could otherwise be caused by inappropriate waste handling of this product. For more detailed information about recycling of this product, please contact your local council office, your household waste disposal service or the shop where you purchased the product.

TECHNICAL SPECIFICATIONS

The manufacturer reserves the right to make changes to the technical specifications of the product

Nominal Voltage - Power Rating - Power Supply	See label on the inside of the service door
Housing material	Thermoplastic material
Size (w x h x d)	215 x 330 x 429 mm / 8.5 x 13 x 16.9 inches
Weight	7.2 kg / 16 pounds
Power cord length	800 - 1200 mm / 32-47 inches
Control panel	Front panel
Automatic Milk Frother	Special for cappuccino
Cup sizes	up to 178mm / 7 inches
Water Tank	1.8 liters - Removable type
Coffee bean hopper capacity	250 g / 1 cup
Coffee grounds drawer capacity	15
Pump pressure	15 bar
Boiler	Stainless steel type
Safety devices	Thermal fuse

WARRANTY AND SERVICE

Warranty

For detailed information on your warranty and related conditions, please read the warranty booklet supplied separately.

Service

We want to ensure that you remain satisfied with your machine. If you have not already done so, please register your purchase at **www.philips.com/welcome**. This will enable us to stay in contact with you and send you cleaning and descaling reminders.

If you need service or support, please visit the Philips website at **www.philips.com/support** or contact the Philips Saeco hotline in your country. The contact details can be found in the warranty booklet supplied separately or on **www.philips.com/support**.

ORDERING MAINTENANCE PRODUCTS

For cleaning and descaling, use Saeco maintenance products only. You can purchase these at the Philips online shop at www.shop.philips.com/service, your local dealer or at authorised service centres.

If you have any difficulties obtaining maintenance products for your machine, please contact the Philips Saeco hotline in your country.

The contact details can be found in the warranty booklet supplied separately or on www.philips.com/support.

Overview of maintenance products:



- Descaling solution CA6700



- INTENZA+ Water filter cartridge CA6702

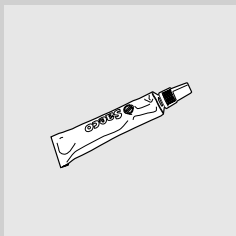

- Grease HD5061



- Coffee Oil Remover CA6704

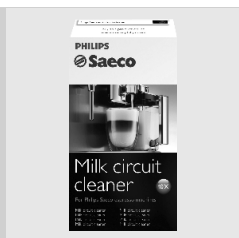

- Milk Circuit Cleaner: CA6705



- Maintenance Kit CA 6706



The manufacturer reserves the right to make changes without prior notice.

www.philips.com/welcome



421944010581

Rev.00 del 15-06-13

Free Manuals Download Website

<http://myh66.com>

<http://usermanuals.us>

<http://www.somanuals.com>

<http://www.4manuals.cc>

<http://www.manual-lib.com>

<http://www.404manual.com>

<http://www.luxmanual.com>

<http://aubethermostatmanual.com>

Golf course search by state

<http://golfingnear.com>

Email search by domain

<http://emailbydomain.com>

Auto manuals search

<http://auto.somanuals.com>

TV manuals search

<http://tv.somanuals.com>