

S·zone

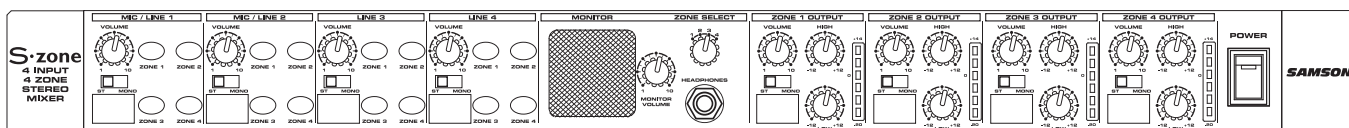

4 INPUT 4 ZONE STEREO MIXER

Owners Manual

SAMSON
A U D I O

Safety Instructions/Consignes de sécurité/Sicherheitsvorkehrungen/Instrucciones de seguridad



WARNING: To reduce the risk of fire or electric shock, do not expose this unit to rain or moisture. To reduce the hazard of electrical shock, do not remove cover or back. No user serviceable parts inside. Please refer all servicing to qualified personnel. The lightning flash with an arrowhead symbol within an equilateral triangle, is intended to alert the user to the presence of uninsulated "dangerous voltage" within the products enclosure that may be of sufficient magnitude to constitute a risk of electric shock to persons. The exclamation point within an equilateral triangle is intended to alert the user to the presence of important operating and maintenance (servicing) instructions in the literature accompanying the product.

Important Safety Instructions

1. Please read all instructions before operating the unit.
2. Keep these instructions for future reference.
3. Please heed all safety warnings.
4. Follow manufacturers instructions.
5. Do not use this unit near water or moisture.
6. Clean only with a damp cloth.
7. Do not block any of the ventilation openings. Install in accordance with the manufacturers instructions.
8. Do not install near any heat sources such as radiators, heat registers, stoves, or other apparatus (including amplifiers) that produce heat.
9. Do not defeat the safety purpose of the polarized or grounding-type plug. A polarized plug has two blades with one wider than the other. A grounding type plug has two blades and a third grounding prong. The wide blade or third prong is provided for your safety. When the provided plug does not fit your outlet, consult an electrician for replacement of the obsolete outlet.
10. Protect the power cord from being walked on and pinched particularly at plugs, convenience receptacles and at the point at which they exit from the unit.
11. Unplug this unit during lightning storms or when unused for long periods of time.
12. Refer all servicing to qualified personnel. Servicing is required when the unit has been damaged in any way, such as power supply cord or plug damage, or if liquid has been spilled or objects have fallen into the unit, the unit has been exposed to rain or moisture, does not operate normally, or has been dropped.

ACHTUNG: Um die Gefahr eines Brandes oder Stromschlags zu verringern, sollten Sie dieses Gerät weder Regen noch Feuchtigkeit aussetzen. Um die Gefahr eines Stromschlags zu verringern, sollten Sie weder Deckel noch Rückwand des Geräts entfernen. Im Innern befinden sich keine Teile, die vom Anwender gewartet werden können. Überlassen Sie die Wartung qualifiziertem Fachpersonal. Der Blitz mit Pfeilspitze im gleichseitigen Dreieck soll den Anwender vor nichtisolierter "gefährlicher Spannung" im Geräteinnern warnen. Diese Spannung kann so hoch sein, dass die Gefahr eines Stromschlags besteht. Das Ausrufezeichen im gleichseitigen Dreieck soll den Anwender auf wichtige Bedienungs- und Wartungsanleitungen aufmerksam machen, die im mitgelieferten Informationsmaterial näher beschrieben werden.

Wichtige Sicherheitsvorkehrungen

1. Lesen Sie alle Anleitungen, bevor Sie das Gerät in Betrieb nehmen.
2. Bewahren Sie diese Anleitungen für den späteren Gebrauch gut auf.
3. Bitte treffen Sie alle beschriebenen Sicherheitsvorkehrungen.
4. Befolgen Sie die Anleitungen des Herstellers.
5. Benutzen Sie das Gerät nicht in der Nähe von Wasser oder Feuchtigkeit.
6. Verwenden Sie zur Reinigung des Geräts nur ein feuchtes Tuch.
7. Blockieren Sie keine Belüftungsöffnungen. Nehmen Sie den Einbau des Geräts nur entsprechend den Anweisungen des Herstellers vor.
8. Bauen Sie das Gerät nicht in der Nähe von Wärmequellen wie Heizkörpern, Wärmeklappen, Öfen oder anderen Geräten (inklusive Verstärkern) ein, die Hitze erzeugen.
9. Setzen Sie die Sicherheitsfunktion des polarisierten oder geerdeten Steckers nicht außer Kraft. Ein polarisierter Stecker hat zwei flache, unterschiedlich breite Pole. Ein geerdeter Stecker hat zwei flache Pole und einen dritten Erdungsstift. Der breitere Pol oder der dritte Stift dient Ihrer Sicherheit. Wenn der vorhandene Stecker nicht in Ihre Steckdose passt, lassen Sie die veraltete Steckdose von einem Elektriker ersetzen.
10. Schützen Sie das Netzkabel dahingehend, dass niemand darüber laufen und es nicht geknickt werden kann. Achten Sie hierbei besonders auf Netzstecker, Mehrfachsteckdosen und den Kabelanschluss am Gerät.
11. Ziehen Sie den Netzstecker des Geräts bei Gewittern oder längeren Betriebspausen aus der Steckdose.
12. Überlassen Sie die Wartung qualifiziertem Fachpersonal. Eine Wartung ist notwendig, wenn das Gerät auf irgendeine Weise, beispielsweise am Kabel oder Netzstecker beschädigt wurde, oder wenn Flüssigkeiten oder Objekte in das Gerät gelangt sind, es Regen oder Feuchtigkeit ausgesetzt war, nicht mehr wie gewohnt betrieben werden kann oder fallen gelassen wurde.

ATTENTION: Pour éviter tout risque d'électrocution ou d'incendie, ne pas exposer cet appareil à la pluie ou à l'humidité. Pour éviter tout risque d'électrocution, ne pas ôter le couvercle ou le dos du boîtier. Cet appareil ne contient aucune pièce remplaçable par l'utilisateur. Confiez toutes les réparations à un personnel qualifié. Le signe avec un éclair dans un triangle prévient l'utilisateur de la présence d'une tension dangereuse et non isolée dans l'appareil. Cette tension constitue un risque d'électrocution. Le signe avec un point d'exclamation dans un triangle prévient l'utilisateur d'instructions importantes relatives à l'utilisation et à la maintenance du produit.

Consignes de sécurité importantes

1. Veuillez lire toutes les instructions avant d'utiliser l'appareil.
2. Conserver ces instructions pour toute lecture ultérieure.
3. Lisez avec attention toutes les consignes de sécurité.
4. Suivez les instructions du fabricant.
5. Ne pas utiliser cet appareil près d'une source liquide ou dans un lieu humide.
6. Nettoyez l'appareil uniquement avec un tissu humide.
7. Veillez à ne pas obstruer les fentes prévues pour la ventilation de l'appareil. Installez l'appareil selon les instructions du fabricant.
8. Ne pas installer près d'une source de chaleur (radiateurs, etc.) ou de tout équipement susceptible de générer de la chaleur (amplificateurs de puissance par exemple).
9. Ne pas retirer la terre du cordon secteur ou de la prise murale. Les fiches canadiennes avec polarisation (avec une lame plus large) ne doivent pas être modifiées. Si votre prise murale ne correspond pas au modèle fourni, consultez votre électricien.
10. Protégez le cordon secteur contre tous les dommages possibles (pincement, tension, torsion,, etc.). Veillez à ce que le cordon secteur soit libre, en particulier à sa sortie du boîtier.
11. Déconnectez l'appareil du secteur en présence d'orage ou lors de périodes d'inutilisation prolongées.
12. Consultez un service de réparation qualifié pour tout dysfonctionnement (dommage sur le cordon secteur, baisse de performances, exposition à la pluie, projection liquide dans l'appareil, introduction d'un objet dans le boîtier, etc.).

PRECAUCION: Para reducir el riesgo de incendios o descargas, no permita que este aparato quede expuesto a la lluvia o la humedad. Para reducir el riesgo de descarga eléctrica, nunca quite la tapa ni el chasis. Dentro del aparato no hay piezas susceptibles de ser reparadas por el usuario. Dirija cualquier reparación al servicio técnico oficial. El símbolo del relámpago dentro del triángulo equilátero pretende advertir al usuario de la presencia de "voltajes peligrosos" no aislados dentro de la carcasa del producto, que pueden ser de la magnitud suficiente como para constituir un riesgo de descarga eléctrica a las personas. El símbolo de exclamación dentro del triángulo equilátero quiere advertirle de la existencia de importantes instrucciones de manejo y mantenimiento (reparaciones) en los documentos que se adjuntan con este aparato.

Instrucciones importantes de seguridad

1. Lea todo este manual de instrucciones antes de comenzar a usar la unidad.
2. Conserve estas instrucciones para cualquier consulta en el futuro.
3. Cumpla con todo lo indicado en las precauciones de seguridad.
4. Observe y siga todas las instrucciones del fabricante.
5. Nunca utilice este aparato cerca del agua o en lugares húmedos.
6. Limpie este aparato solo con un trapo suave y ligeramente humedecido.
7. No bloquee ninguna de las aberturas de ventilación. Instale este aparato de acuerdo a las instrucciones del fabricante.
8. No instale este aparato cerca de fuentes de calor como radiadores, calentadores, hornos u otros aparatos (incluyendo amplificadores) que produzcan calor.
9. No anule el sistema de seguridad del enchufe de tipo polarizado o con toma de tierra. Un enchufe polarizado tiene dos bornes, uno más ancho que el otro. Uno con toma de tierra tiene dos bornes normales y un tercero para la conexión a tierra. El borne ancho o el tercero se incluyen como medida de seguridad. Cuando el enchufe no encaje en su salida de corriente, llame a un electricista para que le cambie su salida anticuada.
10. Evite que el cable de corriente quede en una posición en la que pueda ser pisado o aplastado, especialmente en los enchufes, receptáculos y en el punto en el que salen de la unidad.
11. Desconecte de la corriente este aparato durante las tormentas eléctricas o cuando no lo vaya a usar durante un periodo de tiempo largo.
12. Dirija cualquier posible reparación solo al servicio técnico oficial. Deberá hacer que su aparato sea reparado cuando esté dañado de alguna forma, como si el cable de corriente o el enchufe están dañados, o si se han derramado líquidos o se ha introducido algún objeto dentro de la unidad, si esta ha quedado expuesta a la lluvia o la humedad, si no funciona normalmente o si ha caído al suelo.

Table of Contents

Introduction	2
S zone Features	3
Controls and Functions	
Front Panel Layout	4
Rear Panel Layout	5
Designing an Installation Plan	6-7
Connecting the S zone	
Connecting the S zone Inputs	8-10
Connecting the S zone Zone Outputs	11
Operating the S zone	
Using the S zone Input Section	12
Set the Input for Stereo or Mono operation	12
Using the Zone Assignment switches	12
Using the VOLUME Control	12
Using the Monitor Section	13
Using the headphone	13
Controlling the Zone Outputs	14
Setting the Output level	14
Setting the Zone Output EQ For Voice	15
Setting the Zone Output EQ For Music	15
Using the Ducker	
Setting The DUCK ENABLE switches	16
Channel 1 DUCK ENABLE	16
Channel 2 DUCK ENABLE	16
CHANNEL 1 MASTER	16
Usng the Ducker-Switch Chart	17
S zone System Configurations	18-19
S zone Wiring Guide	20
Specifications	21
S zone Block Diagram	22
Notes	23-24

Copyright 2004, Samson Technologies Corp.

Printed October , 2004

Samson Technologies Corp.
575 Underhill Blvd.
P.O. Box 9031
Syosset, NY 11791-9031
Phone: 1-800-3-SAMSON (1-800-372-6766)
Fax: 516-364-3888
www.samsontech.com

Introduction

Congratulations on purchasing the Samson S zone, four channel, stereo zone mixer! Although this product is designed for easy operation, we suggest you take some time out first to go through these pages so you can fully understand how we've implemented a number of unique features.

The S zone is a professional quality 4-channel zone mixer that allows you to mix just about any audio signal including those from microphones, stereo CD and tape players, video players, and then lets you distribute an independent mix to any of the four stereo zones. Each of the input channels is assignable to any or all of 4 stereo zones outputs via easy to use LED backlit switches. The microphone inputs can be set to "duck" the zone inputs so that the background music automatically turns down when an announcement is made. On each the S zone's outputs, you'll find a convenient two-band equalizer allowing you to adjust the overall tonal response of each zone. A five-segment LED bar VU meter is present on all outputs providing a visual display of the level of each zone. Perhaps the most unique feature of the S zone is it's front panel monitor section. The zone assignment switch, headphone jack, level control and internal super speaker allow you to monitor the signal that is playing in any zone directly on the S zone, without having to physically be in the room that signal is playing in. The handy scribe strip for both the inputs and outputs make it easy to label the connected gear and the rooms the S zone is feeding. For easy installation, all the S zone connections are made with standard Euroblock connection strips.

In this manual, you'll find a detailed description of the features of the S zone, as well as a guided tour through the front and rear panels, step-by-step instructions for using the unit, suggested applications and full specifications.

You'll also find a warranty card enclosed—please don't forget to fill it out and mail it so that you can receive online technical support and so we can send you updated information about other Samson products in the future. Also, be sure to check out our website (www.samsontech.com) for complete information about our full product line.

With proper care and adequate air circulation, your S zone will operate trouble free for many years. We recommend you record your serial number in the space provided below for future reference.

Serial number: _____

Date of purchase: _____

Should your unit ever require servicing, a Return Authorization number (RA) must be obtained before shipping your unit to Samson. Without this number, the unit will not be accepted. Please call Samson at 1-800-3SAMSON (1-800-372-6766) for a Return Authorization number prior to shipping your unit. Please retain the original packing materials and if possible, return the unit in the original carton and packing materials.

S zone Features

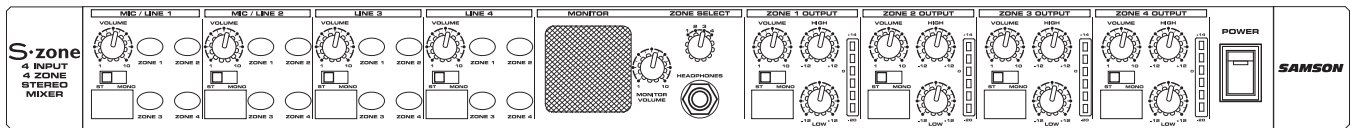

The Samson S zone four-channel stereo zone mixer utilizes state-of-the-art, high quality audio circuit technology for precise tonal and level control. Here are some of the S zone's main features:

- The S zone has four stereo Input Channels with a Volume control, Stereo/Mono switch and our dedicated Zone assignment switches.
- Channel 1 and Channel 2 inputs feature a high quality microphone pre-amp with phantom power allowing you to connect just about any dynamic or condenser microphone.
- The S zone features four stereo Zone Outputs, each with a Stereo/Mono switch, Volume control, High and Low equalizers and a six-segment LED bar VU Meter monitoring the output level, enabling you to control the overall level and tone independently for four discreet coverage areas.
- A remote Volume Control for each Zone Output, up to 3000 feet in distance is possible using standard 50k –100k linear taper potentiometer and two-conductor shielded wire.
- Microphone "Duck" switch on Channel 1 and Channel 2, which when turned on, allow any signal from the microphone inputs, like an announcement or page, to automatically lower the background music level.
- The S zone features a unique front panel monitor section including a zone assignment switch, head-phone jack, level control and internal super speaker allowing you to monitor the signal that is playing in any zone directly on the S zone, without having to physically be in the room that the signal is playing in.
- Ultra-low noise circuitry with high quality op-amps ensure superb audio fidelity.
- Electronically balanced and unbalanced input and output connections are made via easy to use Euroblock connection strips.
- Internal power supply ensures reliability and trouble-free operation.
- Standard 19" rack design (the S zone requires only a single rack space) for easy integration into any traveling or fixed installation audio system.
- Optional security cover kit prevents S Zone settings from accidentally being altered.
- All-steel chassis makes the S zone eminently road-worthy.
- Three year extended warranty.

Controls and Functions

Front Panel Layout

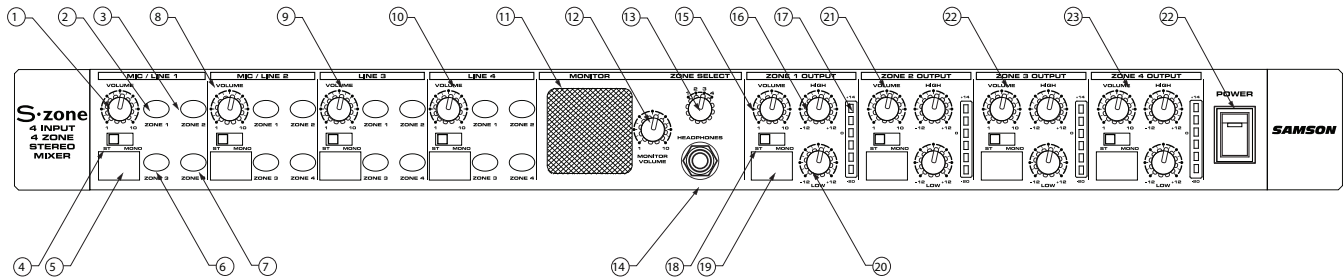

INPUT SECTION

- 1 **VOLUME** – Rotary control used to adjust the level of signal source connected to channel 1.
- 2 **ZONE 1** – When the LED Backlit switch is pressed in, the switch lights red and the input is assigned to ZONE 1.
- 3 **ZONE 2** – When the LED Backlit switch is pressed in, the switch lights green and the input is assigned to ZONE 2.
- 4 **STEREO/MONO switch** - This switch is used to select either stereo or mono input.
- 5 **SCRIBE STRIP** – Convenient area for marking the input source allowing you to label the channel with the device connected to the input.
- 6 **ZONE 3** – When the LED Backlit switch is pressed in, the switch lights amber and the input is assigned to ZONE 3.
- 7 **ZONE 4** – When the LED Backlit switch is pressed in, the switch lights orange and the input is assigned to ZONE 4.
- 8 **MIC/LINE 2** – Channel 2 input with the same knob and switch complement as Channel 1.
- 9 **LINE 3** – Channel 3 input with the same knob and switch complement as Channel 1.
- 10 **LINE 4** – Channel 4 input with the same knob and switch complement as Channel 1.

MONITOR SECTION

- 11 **MONITOR SPEAKER** – This built-in, miniature super-speaker allows you to listen to the signal that is present at any ZONE OUTPUT.
- 12 **MONITOR VOLUME** - This rotary control is used to adjust the monitor level heard in the front panel Headphone jack or SUPER SPEAKER.

- 13 **ZONE SELECT switch** – This four-position switch is used to assign any of the four Zones to play in the MONITOR SPEAKER or HEADPHONE JACK.
- 14 **HEADPHONE JACK** - Connect any standard stereo headphone using a standard 1/4-inch jack to monitor the ZONE OUTPUTS.

ZONE OUTPUT SECTION

- 15 **VOLUME** – This rotary control is used to control the overall level of OUTPUT ZONE 1.
- 16 **HIGH** – High frequency equalizer rotary control with +/-12 dB of cut or boost at 10kHz.
- 17 **OUTPUT METER** – Six-segment LED meter displaying the level of the ZONE 1 OUTPUT with -20 to +14 dB indicators.
- 18 **STEREO/MONO switch** - This switch is used to select either stereo or mono operation on the ZONE 1 OUTPUT.
- 19 **SCRIBE STRIP** – Convenient area for marking the ZONE OUTPUT allowing you to notate the room or area the zone is feeding.
- 20 **LOW**– Low frequency equalizer rotary control with +/-12 dB of cut or boost at 100Hz.
- 21 **ZONE OUTPUT 2** – ZONE 2 OUTPUT with the same knob and switch complement as ZONE 1 OUTPUT.
- 22 **ZONE OUTPUT 3** – ZONE 3 OUTPUT with the same knob and switch complement as ZONE 1 OUTPUT.
- 23 **ZONE OUTPUT 4** – ZONE 4 OUTPUT with the same knob and switch complement as ZONE 1 OUTPUT.
- 24 **POWER switch** – Use this switch to power the unit on and off.

Controls and Functions

Rear Panel Layout

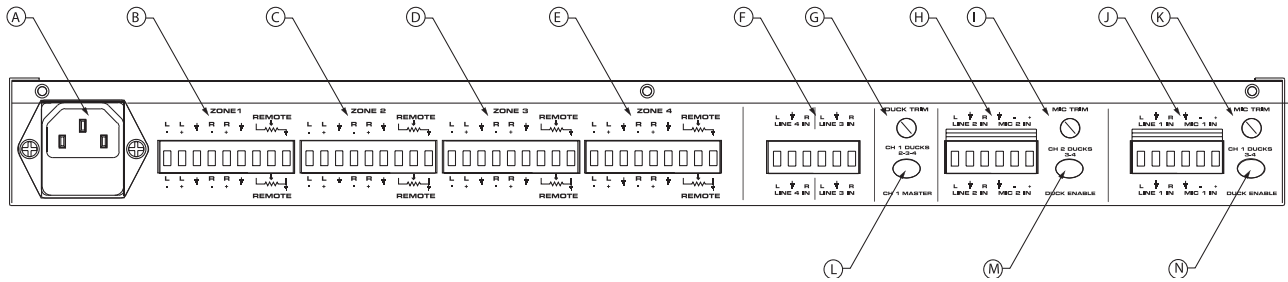

- A AC INPUT FUSE HOLDER** – Connect the supplied 3-pin IEC power cable here.
- B ZONE 1 OUTPUT** – This connector includes the Zone 1 Left and Right balanced output connections, along with the connections for the REMOTE volume control.
- C ZONE 2 OUTPUT** – This connector includes the Zone 2 Left and Right balanced output connections, along with the connections for the REMOTE volume control.
- D ZONE 3 OUTPUT** – This connector includes the Zone 3 Left and Right balanced output connections, along with the connections for the REMOTE volume control.
- E ZONE 4 OUTPUT** – This connector includes the Zone 4 Left and Right balanced output connections, along with the connections for the REMOTE volume control.
- F LINE 3 AND 4 INPUT** - This connector is used to hook up the LINE 3 and 4 Left and Right input connections.
- G DUCK TRIM** – This rotary control is used to adjust how much signal level is dropped when the microphone activates the DUCK circuit.
- H MIC/LINE 2** – This connector includes the connection for a stereo line level and mono microphone input for channel 2.
- I MIC TRIM** – The rotary control is used to adjust the input sensitivity of the microphone pre amplifier on channel 2.
- J MIC/LINE 1** – This connector includes the connection for a stereo line level and mono microphone input for channel 1.
- K MIC TRIM** – The rotary control is used to adjust the input sensitivity of the microphone pre amplifier on channel 2.
- L CH 1 MASTER switch** – This switch is used to enable the ducking function on channels 2, 3 and 4.
- M DUCK ENABLE**– Channel 2 will act as a ducking master when this switch is pressed in and the volume of channels 3 and 4 will automatically be lowered when the there is a microphone signal on Channel 2.
- N DUCK ENABLE** – Channel 1 will act as a ducking master when this switch is pressed in and the volume of channels 3 and 4 will automatically be lowered when the there is a microphone signal on Channel 1.

Designing an Installation Plan

Designing an Installation Plan

If you are a professional installer, you'll probably want to skip over this section, however if you are setting up your system for the first time this section can help make your installation a little bit easier.

Before you start plugging, stripping and connecting wires, it a good idea to have a clear installation plan. To create your installation plan you need to consider several design parameters including what sound sources will be used, if announcement paging is necessary, which rooms need to have sound, is remote volume control required, which type of speakers will do the best job for the room they are covering, and your wire plan.

Selecting the Sound Sources

The S zone provides four input channels with the ability to connect up to six input sources. On input Channel's 1 and 2 there is an input for connecting microphones with phantom power to operate condenser type mics. You can connect line level signals on all four input channels, so signals from TAPE, CD, DVD or Karaoke players, Audio Video TV monitors, Radio Tuners, DJ mixers or any other line level device can be used as a sound source. You may also be able to connect the output from a Home Hi-fi receiver if it's equipped with a line level output. For example, in a small to medium size restaurant you may want background music from a CD in a room, Disco Karaoke in another room and have the ability to have a hostess paging parties for their tables, and a cook paging a waitress to pick up an order. The S zone can accomplish all of this easily.

Creating the Audio Zones

You can create separate audio environments using the S zone's four output channels. Obviously, (or not perhaps not so obviously,) we call an output a zone on the unit, but a zone is also the area where you want to have sound. So, think about where you want to distribute the sound. The S zone can accomplish all of this easily. In addition, the S zone let's you easily connect a remote control level for each of the zones, so you can control the volume in the room even if the audio equipment is located somewhere else.

Now, take some time to consider where you need to have sound in your particular installation. After you have decided where you need to create sound zones, you can consider your speaker selection, but first decide where you are going to locate your equipment rack.

Locating Your Equipment Rack

Since the S zone is standard 19-inch rack mount device, you should consider using an equipment rack, such as the Samson SRK8. To select a good location for your equipment rack you should consider several points including the proximity to each of the sound zones, if the users need to access the gear like to change CD's or to adjust a volume level and if you have a convenient location to the electrical service, to name a few. You will need to consider the length of wire runs and routing necessary to make the connections from the equipment rack to the various sound zones. Depending on the speakers you choose, and the length of cable runs you need to make, you may choose to run speaker level or line level to the sound zones. If you are using passive (non-powered) speakers you will need to connect the S zone to a power amp and run speaker wire, however you need to be careful to pay attention to the wire gauge and total length of the wire run. If you are using powered (active) speakers you can run long distances using the balanced outputs directly from the S zone.

Another type of installation is one that uses speakers and amplifiers with 70-volt transformers. The benefit of these systems you can run long lengths of wire and have many speakers connected to a single amplifier. Since the equipment used in these types of installations are fairly specialized, you'll probably need professional help. Only a licensed and insured professional sound contractor should perform installations of 70-volt systems.

Selecting Speakers for Each Zone

To select the speakers you need to consider a few important issues like where you are going to place your power amplifiers, using powered or un-powered speakers, or if you need to run a 70-volt distributed sound system. The following sections provide an overview on how to connect passive speaker or active speakers in a typical installation.

Designing an Installation Plan

Using Passive Speakers

If you are using passive (un-powered) speakers you need to first decide where you will place your power amplifier. If the speakers in a particular sound zone are less than 100 feet away you can locate your power amplifier in the same rack as the S zone and wire the speaker wires from the amplifier to your sound zone.

NOTE: This type of wiring is known as "home-run wiring" since you are making direct connection from the amplifiers in the equipment rack to the speakers located in the sound zone room.

In this case, you would connect the S zone's Zone Output to the power amplifier input and then run the speaker wires to the passive speakers. If the speakers in a particular sound zone are further than 100 feet, you should consider placing the amplifier in the same room as the sound zone. In this case you will run balanced line level signal from the S zone's Zone Output over the long wire run to the input of the power amplifier located in the sound zone.

Using Active Speakers

If you are going more than 100 feet you can also consider using active speakers (speakers with built in power). When using active speakers you can connect the S zone's outputs using the balanced line level signals. In this case you will run line level signal from the S zone's Zone Output over the long wire run to the input of the powered speaker located in the sound zone. For more information on wiring for balanced signals see the wire guide on page 20 of this manual.

Setting up the S zone

Quick Start

We recommend that you take the time to read through this manual, and then, use it as a reference guide. If you are installing your first system you should read through the section "Designing an Installation Plan" on page 6 before you start connecting your S zone. If you're a professional installer you can skip over that section and if you want to get started running some signals through your inputs and outputs, you can follow the following quick start example.

Setting up your S zone is a simple procedure, which takes only a few minutes. The following section describes the set-up and operation of a simple installation using the S zone with a CD player and paging microphone.

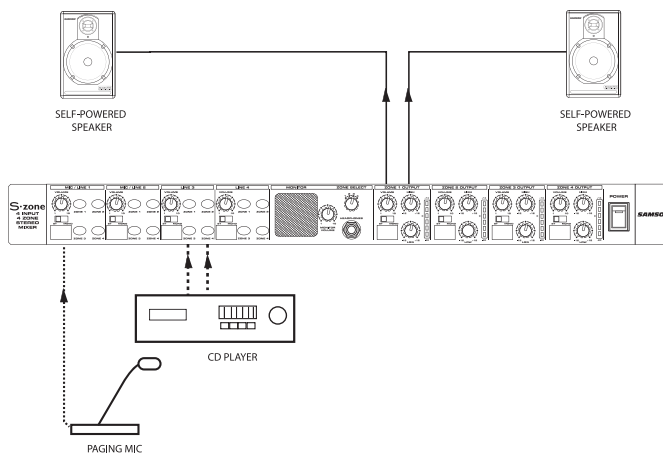

In this set up example, a paging microphone connected to the S zone's CHANNEL 1 input and a CD player connected to CHANNEL 3. The S zone's ZONE OUTPUT 1 is connected to a pair of active (self powered) speakers. If you are using passive speakers, the S zone's ZONE OUTPUT should be connected to the power amp input.

- Remove all packing materials (save them in case of need for future service) and decide where the unit is to be physically placed—it can be used freestanding or mounted in a standard 19" rack (The S zone requires only a single rack space).
- Make sure the power to all input sources (like CD, DVD, MP3 & TAPE players) and amplifiers in your audio system is off.
- Turn the volume control of your active speakers all the way off. If you are using passive speakers with a separate power amplifier, be sure to turn the power amp volume controls all the way off.

- On the front panel of the S zone, set all the VOLUME control knobs to their bottom-most "OFF" setting.
- Set all ZONE OUTPUT LOW and HIGH Equalizer control Knobs to their flat ("0") center detented position.
- Now, make the S zone input connections, using the Euroblock connectors on the rear panel.

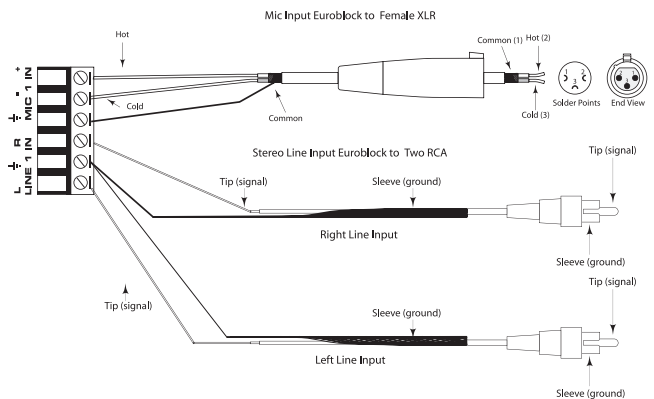

- Next, make the S zone output connections, using the Euroblock connectors on the rear panel.

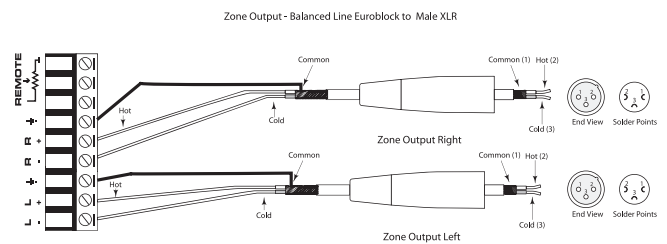

- Plug in the supplied AC connector and connect it to any standard AC socket.
- Press the front panel Power switch in order to turn on the S zone.
- Power on your CD player, then power your active speaker or power amp.
- On the Line 3 input channel, press the Zone 1 Switch.
- Apply an input signal from the CD player to the S zone and slowly raise the front panel LINE 3 Volume control knob to the "0" point.
- While the input signal is present, slowly raise the front panel ZONE OUTPUT 1 control knob to the "0" point (if sending signal from a CD Player, drive the mixer's output meters at approximately 0 VU).

Setting up the S zone

Quick Start - continued

- Once you get a good level reading on the ZONE OUTPUT VU meter, you can begin to slowly raise the volume control on your active speakers or power amp.

Now experiment with the level using both the Zone 1 Output and the power amp input level. On active speakers, there is usually a unity gain or 0 dB point on the volume control knob and you should set the control to that position to start. Then, you may need to lower the ZONE OUTPUT VOLUME control, or the speaker's volume control to set the proper level that you want in your particular room. If you are using a power amp, you may want to turn the power amp all the way up, and again, you may need to lower the ZONE OUTPUT VOLUME control to set the proper level. You may also need to lower the ZONE OUTPUT VOLUME control, or the power amp's volume control to set the proper level that you want in your particular room. This concept is known as "gain staging" and it is the most important part of getting a good sound. Ideally, you want the S zones Output level meter to read about 0 dB. This will give you the best signal to noise performance and cleanest sound. So, try to adjust the Zone Output Volume controls so that the VU Meter reads about 0 dB. Then adjust the volume control on the amplifier or speaker to a the desired listening level.

- Now that you have the basic system operation level set, you can get a level setting for your microphone connected to the S zone's CHANNEL 1 input. While speaking into your microphone, slowly raise the VOLUME control knob on CHANNEL 1 to the 0 position.
- At this point if the microphone is very low in volume, raise the level of the rear panel MIC TRIM control. If the microphone is very high in volume, lower the level of the rear panel MIC TRIM control. You want to set the MIC TRIM so that you have a good range of level control on the CHANNEL 1 VOLUME control without adding any distortion.

Note: The MIC TRIM level control allows you to set the best signal to noise level. Very simply put, this means the hottest mic level with the least amount of distortion. If the MIC TRIM is too low, the mic level may not be loud enough. If the MIC TRIM is set too high, the channel will distort. Use your ears to set the MIC TRIM to the highest point before you hear any distortion.

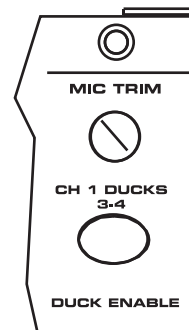

Mic Trim

- Experiment by moving each of the CHANNEL VOLUME control knobs up and down, carefully listening to get the best balance between your microphone and music from your CD player.

Now, read on and learn about more different wiring hook-ups and more on using some of the S zones advance features.

If you have followed all the steps above and are experiencing difficulties with any aspect of setting up or using your S zone, you can call Samson Technical Support (1-800-372-6766) between 9 AM and 5 PM EST, or contact your local distributor.

Connecting the S zone

Get Connected!

The S zone's rear panel is where you will find all (except the headphone jack) of the input and output connections. The S zone provides four input channels that can accept up to four line level sources and two microphones and four output channels to feed the sound zones. The connections for these inputs and outputs are made via standard Euroblock connectors (the mating ends to connect to your wires have been included). The Euroblock connectors are easy to wire-up; just strip your wire, insert it into the Euroblock connector and tighten down the screws. The next section of this manual will detail the connections for the S zone's inputs and outputs.

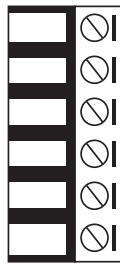

Euroblock Connector

Connecting the S zone Inputs

After you have designed a plan for your installation you will need to connect your audio sources to the S zone's inputs. You may want to connect several devices like microphones for paging, and other line level devices like CD, DVD, MP3, TAPE or Karaoke players or perhaps a radio tuner. Regardless of the sound source, it's important to connect the inputs properly. Follow the section and wiring diagrams below to connect your input sources. The microphone inputs accept low impedance (100 to 600 ohms) balanced or unbalanced microphones.

Connect your microphones to inputs channel 1 and 2 using the following wiring guide.

Note: The S zone always provides 15 volts of phantom power to the microphone inputs so you'll have no problem using just about any condenser microphone. Dynamic microphones can be connected as well.

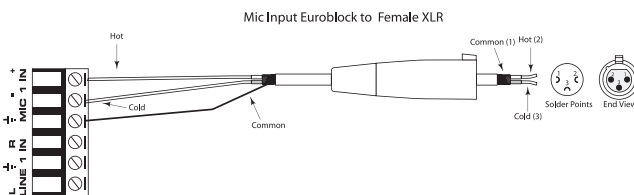

Mic Input Wiring for Channel 1 and 2

Next connect your line inputs to channels 2 using the wiring guide below.

These inputs are set to accept -10 dBV levels, which is the standard for devices like most CD and DVD players.

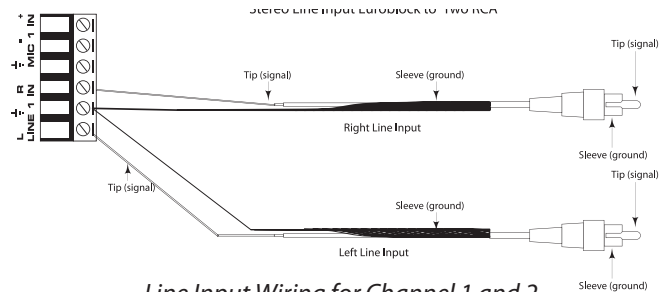

Line Input Wiring for Channel 1 and 2

Now connect your line inputs to channels 3 and 4 using the wiring guide below.

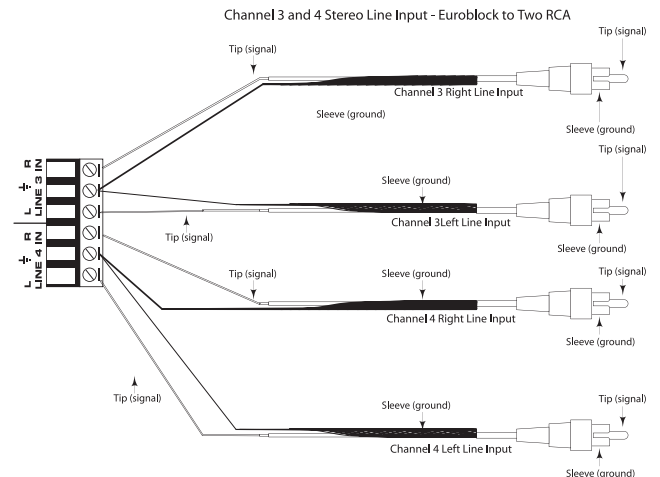

Line Input Wiring for Channel 3 and 4

These inputs are set to accept -10 dBV levels, which is the standard for devices like most CD and DVD players.

Connecting the S zone

Connecting the S zone Zone Inputs - continued

If you need to connect one or two microphones, along with more than two line level input sources, you can use the mic and line inputs for channel 1 and 2 at the same time. You should only do this if you need more than two line inputs. When you connect both the mic and line to the same input you will not be able to control the level of the two input sources individually. So, if possible in this situation, select a line level device that has its own output level control. You can use that level control to help you balance between the line level and the mic connected to the same input. To connect a mic and line input to Channel 1 and Channel 2 at the same time follow the wiring diagram below.

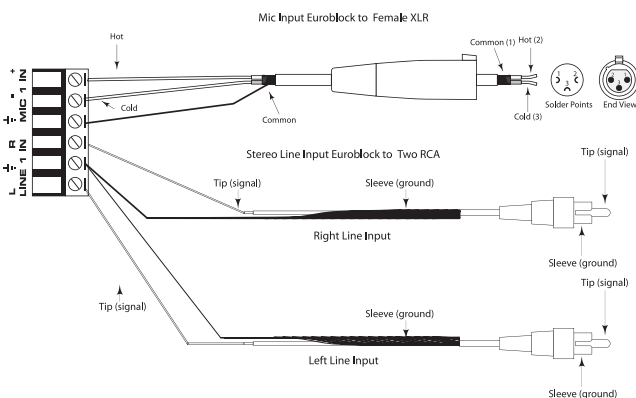

Mic/Line Input Wiring for Channel 1 and 2

Connecting the S zone Zone Outputs

After you have designed a plan for your installation you will need to connect the S zone's Zone Outputs to your power amplifiers or powered speakers. You can wire the S zone's Outputs for balanced or unbalanced. It is highly recommended that you use balanced wiring when you are running long runs of cable, let's say over 20 feet. When you run a balanced wire you benefit from CMR (Common Mode Rejection), which reduces the possibility of noise and hum from other interfering electrical device. Regardless of the sound source, it's important to connect the outputs properly.

To connect the Zone Outputs to a balanced input using standard XLR connectors, follow the wiring diagram below.

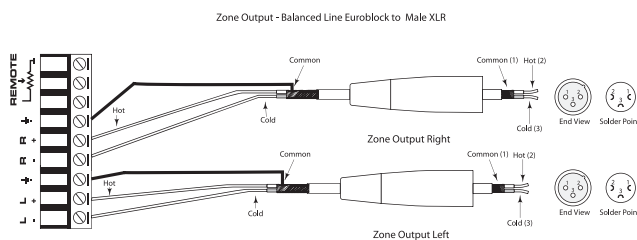

Zone Output Balance Line

To connect the S zone's Zone Outputs to an unbalanced input using standard 1/4-inch connectors, follow the wiring diagram below.

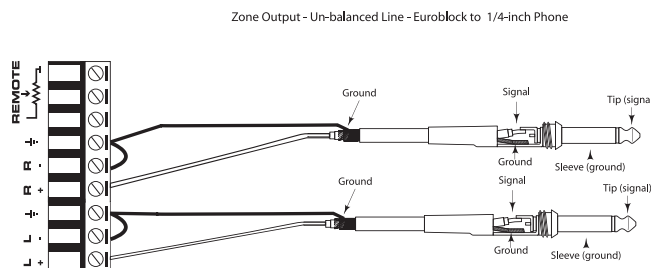

Zone Output Unbalance Line

Operating the S zone

Using the S zone Input Section

The S zone provides four stereo inputs that can also be set to accept mono signals. The input channels are where you will connect your sound sources like CD, DVD player, AV monitor output, paging mics or just about any other audio signal. Channel 1 and 2 also feature a high quality microphone input offering 58 dB of gain and phantom power for using condenser microphones. In addition, Channel 1 and 2 include a ducking feature, which will automatically lower the volume of the line inputs so that an announcement can be heard over the program music material.

The S zone's inputs are laid out in four separate input strips that include a volume control, a stereo/mono selection switch, four zone assignment switches and even a convenient scribe strip for labeling the input source.

Set the Input for Stereo or Mono Operation

The S zone is a stereo device and thanks to the STEREO/MONO switch you can set any of the input channels to accept either stereo or mono signals. If you are connecting a mono source like a microphone, you will want to set the Stereo/Mono switch to the MONO position. By selecting MONO, you do not have to worry about which speakers the mic will be routed to, regardless if you are using a mono or stereo sound zone. If you are connecting a device like a CD or DVD player and you want to run that signal in stereo, set the STEREO/MONO switch to STEREO position. To learn more of output using stereo and mono outputs see the section "Setting the Outputs for Stereo or Mono" operation on page 14 of this manual.

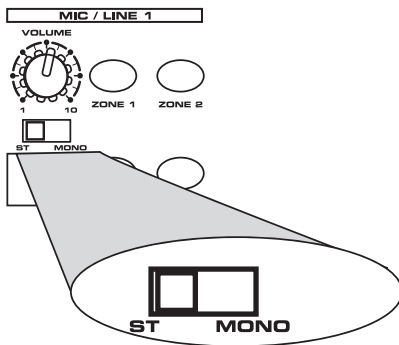

Channel Input Stereo / Mono switch

Using the Zone Assignment switches

The S zone channel input strips each have assignment switches for the four output zones, labeled ZONE 1, ZONE 2, ZONE 3 and ZONE 4. These switches are used to select which of the sound sources will be heard in each of the zones. The switches are backlit with red LED's, which illuminate when the switch is pressed in, indicating the input channel is assigned to the Zone Output. Using these switches, it is possible to choose what you are hearing in each zone. For example you may want make an announcement in the room connected to Zone 1, but not in Zone 2. In this case press the Zone Assign switch 1 on channel one, but do not engage the Zone 2 Assign switch,

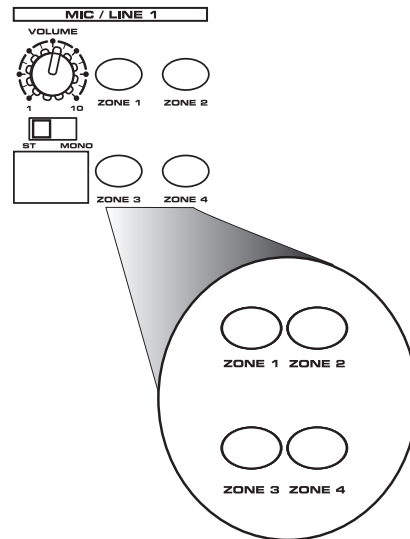

Channel Input Zone Assignment Switches

Using the VOLUME Control

Each channel of the four S zone's channels have an independent level control labeled VOLUME. It's a good idea to start your set-up with all of these turned off (in the fully counterclockwise position). Once you have all the channels connected, and the ZONE assignment is set, you can use the VOLUME control to adjust the level of the channel input in any zone.

Now that you have made the connections for your inputs, you can test the signals by using the S zones MONITOR selection.

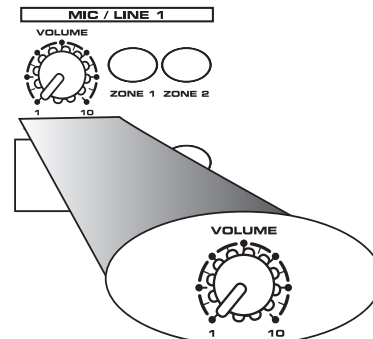

Channel Input Volume

Operating the S zone

Using the Monitor Section

The S zone features a unique monitor section located in the center of the unit allowing the operator or installer to listen to each of the zones in headphones or in the internal super speaker. The added convenience allows the installer or end user to monitor the program material that is playing in each zone from a single location in the building.

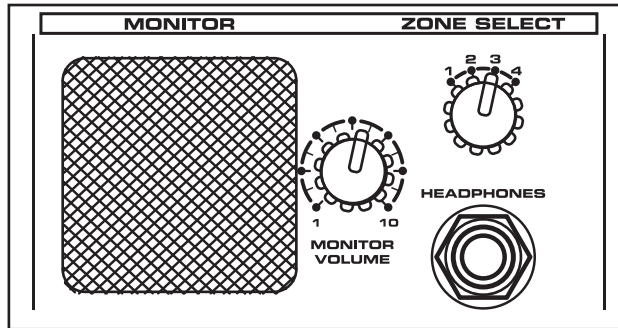

S zone Monitor Section

Using the headphone

Any standard headphone with an impedance of 8 – 200 ohms can be plugged into the front panel PHONES 1/4-inch jack. When a headphone is connected to the PHONES input, the internal super speaker will turn off allowing the user or installer to monitor any zone without disturbing the room ambiance.

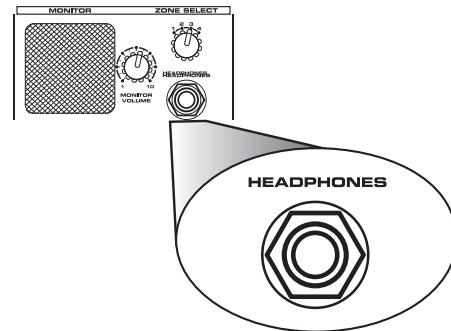

S zone Phones Jack

Selecting the Output

The ZONE SELECT is a four-position switch used to assign any zone to the monitor section for listening in the headphone or internal super speaker.

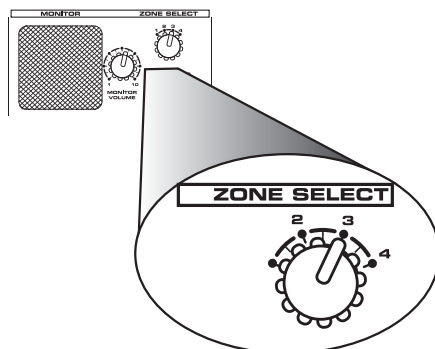

Monitor Section Zone Select Switch

Using the Monitor VOLUME control

When you are monitoring the signal from the selected sound zone, you can use the volume control to adjust the level in the internal Monitor super speaker or in the headphones.

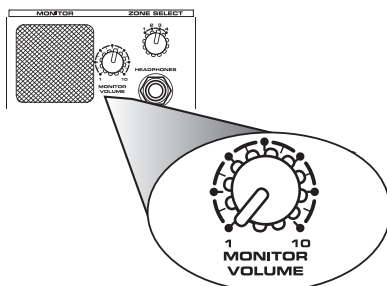

Monitor Section Output Volume Control Knob

Routing a signal to the Internal Monitor

The following section explains a simple procedure to route signal from inputs to outputs, and then monitor the Zone output in the Zone Monitor.

- Connect an input signal like a CD or DVD player to the one of the S zone's line inputs.
- Assign that input to the one or more zones using the input channel ZONE assignment switches.
- Now, adjust the assigned ZONE(s) OUTPUT VOLUME control(s) so that you see the input reading on the output meter(s).
- Position the ZONE SELECT switch to the Zone that you want to hear in the monitor.
- Now, use the Monitor VOLUME control to adjust the level in the speaker or headphone.

Note: If you assigned two or more inputs to different Zone Outputs, you will hear the different signals in the Monitor speaker or headphones as you change the ZONE SELECT switch.

Operating the S zone

Controlling the Zone Outputs

The S zone has four output zones, which are controlled using the four ZONE output strips located on the right side of the front panel. Each Zone Output has its own level control, output meter and two-band equalizer. You can adjust the overall volume using the Level control and even apply some basic equalization to contour the frequency response of the speaker system when necessary. You can also add a label for the zone name using a grease pencil or removable label on the Zone Output Scribe Strip.

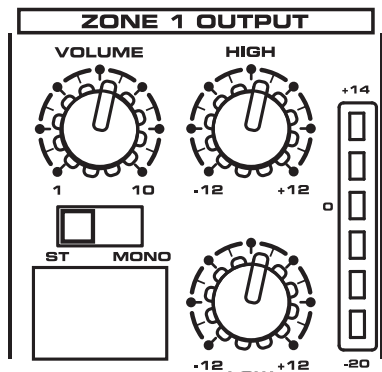

Zone Output Section

Setting the Output level

It's always a good idea to start with all the Zone Volume controls turned all the way down (fully counter-clockwise). Then, follow these steps.

- Once you have a signal playing in the input, assign the input to a zone.
- Now, slowly raise the LEVEL control until you get to the desired level and look for the level display on the zone output meter (approximately 0 VU on the output meter).

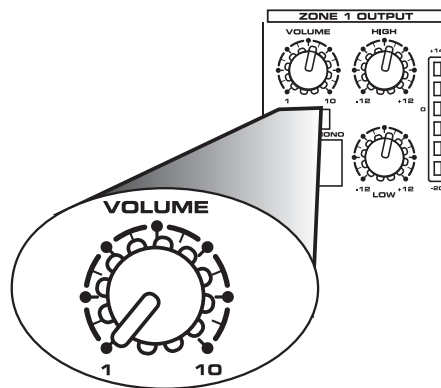

Zone Output Volume

Setting the ZONE OUTPUT for Stereo or Mono Operation

The S zone is a stereo device and thanks to the STEREO/MONO switch you can set any of the ZONE OUTPUT's to send either stereo or mono signals. In many installations, it is desirable to run mono sound zones since the sound is being distributed through several speakers and there is no one position. In other situations like around a cocktail lounge, perhaps a disco/karaoke dance floor in a restaurant or an outside patio in a home installation, you may want to run a stereo sound zone.

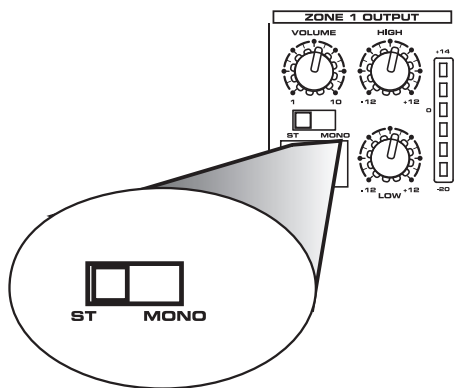

Zone Output Stereo / Mono switch

Operating the S zone

Using the Equalizer

Each of the four Zone Outputs includes a two-band equalizer allowing individual equalization settings on each output channel. Located in the Zone Output section on the right side of the front panel, each output's equalizer features LOW (BASS) and HIGH (TREBLE) controls. By using these controls to adjust the frequency response, you can set an individual tonal contour curve for the speakers connected to each Zone Output. For example if you are using a zone for announcement paging only, you can cut a little of the bass and treble which will produce an equalization contour emphasizing the midrange. For music you can add bass and treble to produce a "Hi-fi" equalization contour.

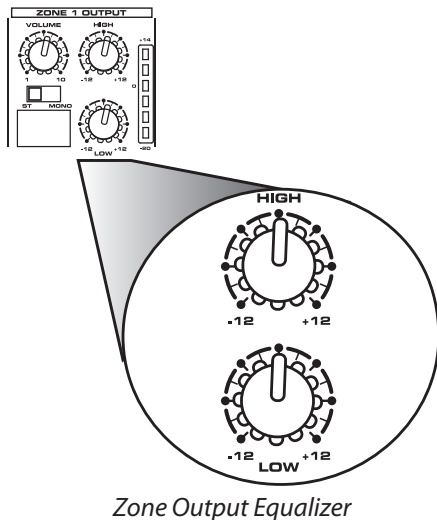

Zone Output Equalizer

The LOW Frequency EQ control provides up to 12 dB of CUT or BOOST at 100 Hz. You'll notice a single detent when the control knob is located in the center of its travel range indicating that there is no boost or cut and that the LOW frequency response of the channel is flat. The HIGH Frequency EQ control provides up to 12 dB of CUT or BOOST at 10kHz. You'll notice a single detent when the control knob is located in the center of its travel indicating that there is no boost or cut and that the HIGH frequency response of the channel is flat..

The next section explains how to apply some common equalization curves to for typical applications.

Setting the Zone Output EQ For Voice

To set the Zone Output equalizer for vocal operation you want to emphasize the midrange response. To do this lower the LOW and HIGH frequency control knobs by about 3dB so set them to the 11:00 position as shown in the following diagram.



Vocal EQ Contour

Setting the Zone Output EQ For Music

To set the Zone Output equalizer for music playback you want to emphasize the bass and a treble like most consumer hi-fi systems. To do this raise the LOW and HIGH frequency control knobs by about 3dB so set them to the 2:00 position as shown in the following diagram.



Music EQ Contour

Note: It's a good idea to test the sound zone with the type of program material (music or speech) that will ultimately be used in the working installation. Your speaker may sound great with little or no added equalization on the Zone Output. You can use an RTA (Real Time Analyzer) like the Samson D1500 to measure the frequency response of the speaker system in any sound zone. If you do not have an analyzer, use your ears and adjust the equalization to a setting that sounds good to you.

Operating the S zone

Using the Ducker

The S zone allows you to set up a sophisticated music and paging system where the background music will automatically lower when an announcement is made. This automatic level control is known as Ducking. The S zone's ducker can operate with either one or two microphones allowing two zone paging. Plus, you can even use a line level source to duck another line level source (for example: applications like one CD player audio advert ducking another playing background music).

Setting The DUCK ENABLE switches

The S zone can use either Channel 1, 2 or even Channel 1 and 2 to duck the line inputs connected to channel three and four. You can even set Channel 1 as a Master channel which will duck the line inputs connected to Channel 3 and 4 and the mic and/or line connected to Channel 2. The next section details the operation of the DUCK ENABLE switches located on the right side of the S zone's rear panel.

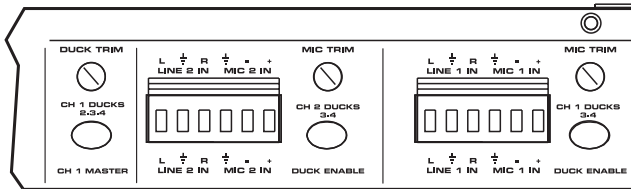

Channel 1 DUCK ENABLE

When the Channel 1 DUCK ENABLE switch is pressed in, when ever signal is present at the input of Channel 1 the level of the inputs connected to Channel 3 and 4 will automatically be lowered by the amount set by the DUCK TRIM control. Once there is no input present on Channel 1, the level of the inputs connected to Channel 3 and 4 will be returned to their normal level. Therefore, you can connect a microphone to Channel 1's input and a CD player to Channel 3's input, press the Channel 1 DUCK ENABLE, and whenever you speak into the microphone, the background music will be lowered. When you stop speaking, the background music will returned to the original level. You can set the DUCK ENABLE on Channel 1 individually or together with the Channel 2 DUCK ENABLE if you need to have two microphones ducking the background music.

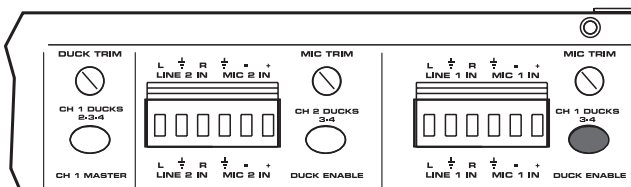

Channel 2 DUCK ENABLE

When the Channel 2 DUCK ENABLE switch is pressed in, when ever signal is present at the input of Channel 2 the level of the inputs connected to Channel 3 and 4 will automatically be lowered by the amount set by the DUCK TRIM control. Once there is no input present on Channel 2, the level of the inputs connected to Channel 3 and 4 will be returned to their normal level. Therefore, you can connect a microphone to Channel 2's input and a CD player to Channel 3's input, press the Channel 2 DUCK ENABLE, and whenever you speak into the microphone, the background music will be lowered. When you stop speaking the background music will returned to the original level. You can set the DUCK ENABLE on Channel 2 individually or together with the Channel 1 DUCK ENABLE if you need to have two microphones ducking the background music.

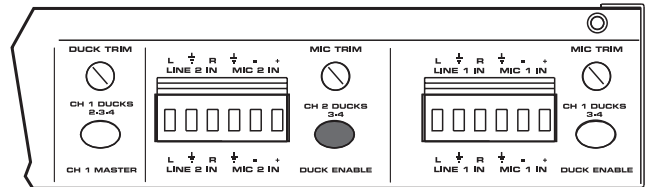

CHANNEL 1 MASTER

If you are using a microphone or line level signal to duck the level of the inputs connected to Channels 2, 3 and 4, you can use the CHANNEL 1 MASTER switch so that Channel 1 will have priority over all the other inputs. With the CHANNEL 1 MASTER selected, when signal is present at the input connected to Channel 1, all other inputs will be lowered by 10dB.

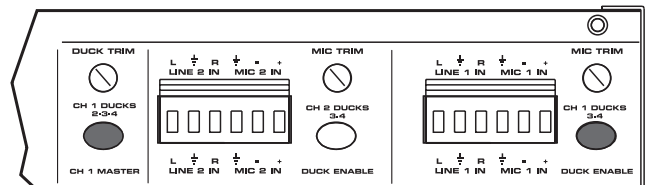





















Operating the S zone

Using the Ducker - continued

You can set the S zone's ducking matrix to seven settings. The diagram below shows the possible settings for using the DUCK ENABLE and MASTER switches.

Follow the grid below and set the S zone Ducker switches to the positions that are best suited for your application.

CHANNEL 1 DUCKS 3-4 DUCK ENABLE	CHANNEL 2 DUCKS 3-4 DUCK ENABLE	CHANNEL 1 MASTER	CHANNEL 1	CHANNEL 2	CHANNEL 3	CHANNEL 4
			MIC / LINE CONTROL		1 DUCKS 3	1 DUCKS 4
				MIC / LINE CONTROL	2 DUCKS 3	2 DUCKS 4
			MIC / LINE CONTROL	MIC / LINE CONTROL	1 OR 2 DUCKS 3	1 OR 2 DUCKS 4
			MIC / LINE CONTROL	1 DUCKS 2	1 DUCKS 3	1 DUCKS 4
			MIC / LINE CONTROL	1 DUCKS 2	1 DUCKS 3	1 DUCKS 4
				NO DUCKING	NO DUCKING	NO DUCKING
				NO DUCKING	NO DUCKING	NO DUCKING

S zone System Configurations

Using the S zone with Active Speakers

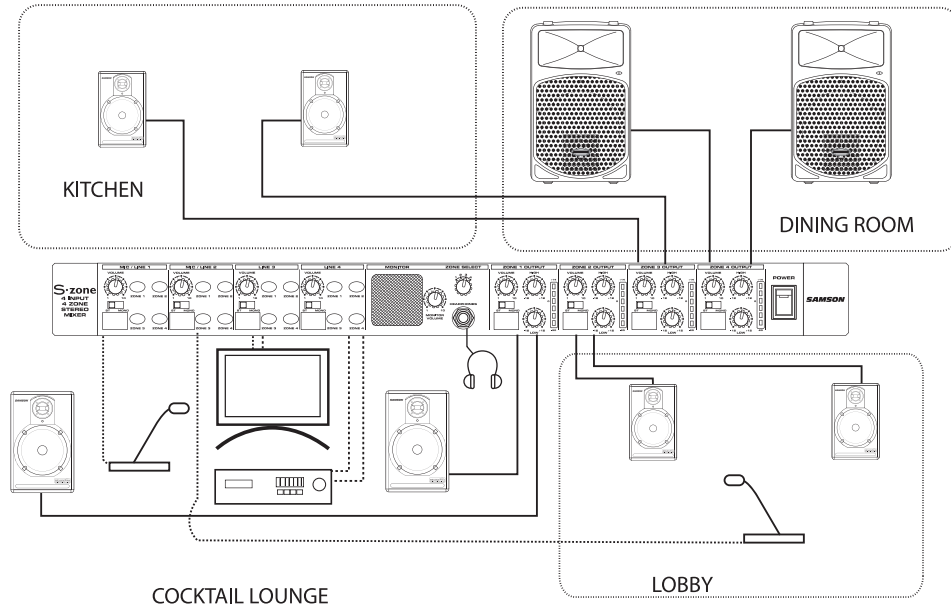

Using the S zone with Passive Speakers

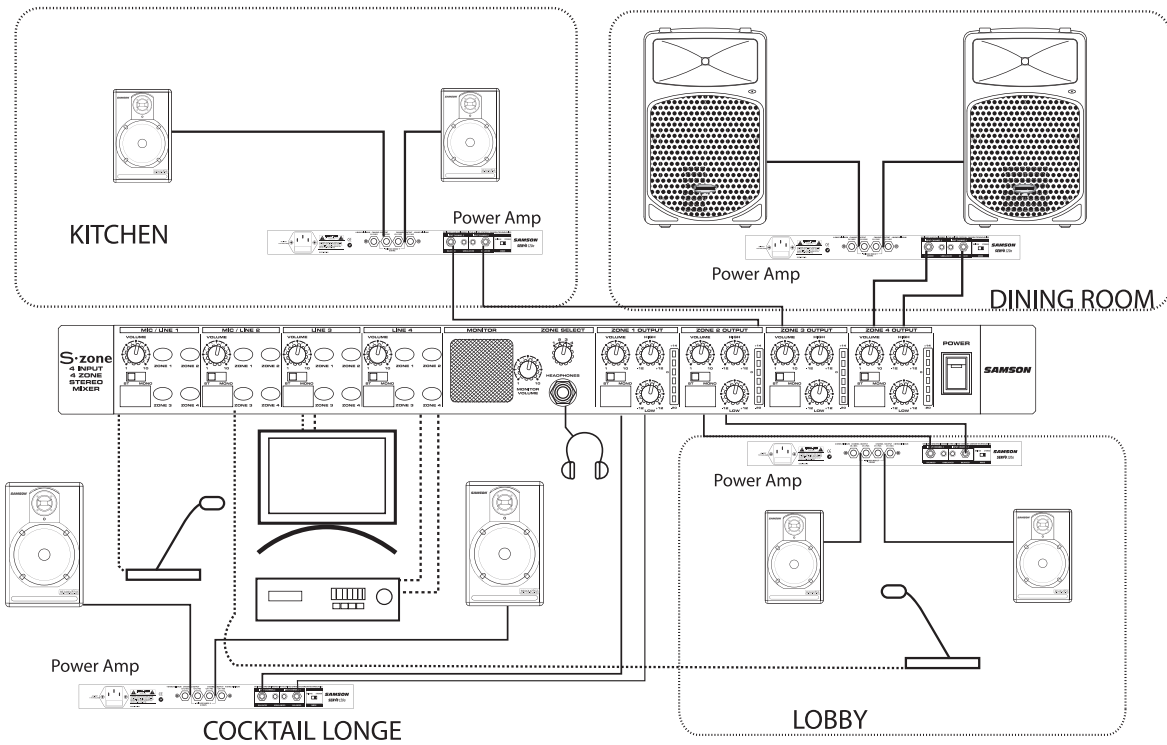

S zone System Configurations

S zone's Four Room Set-up

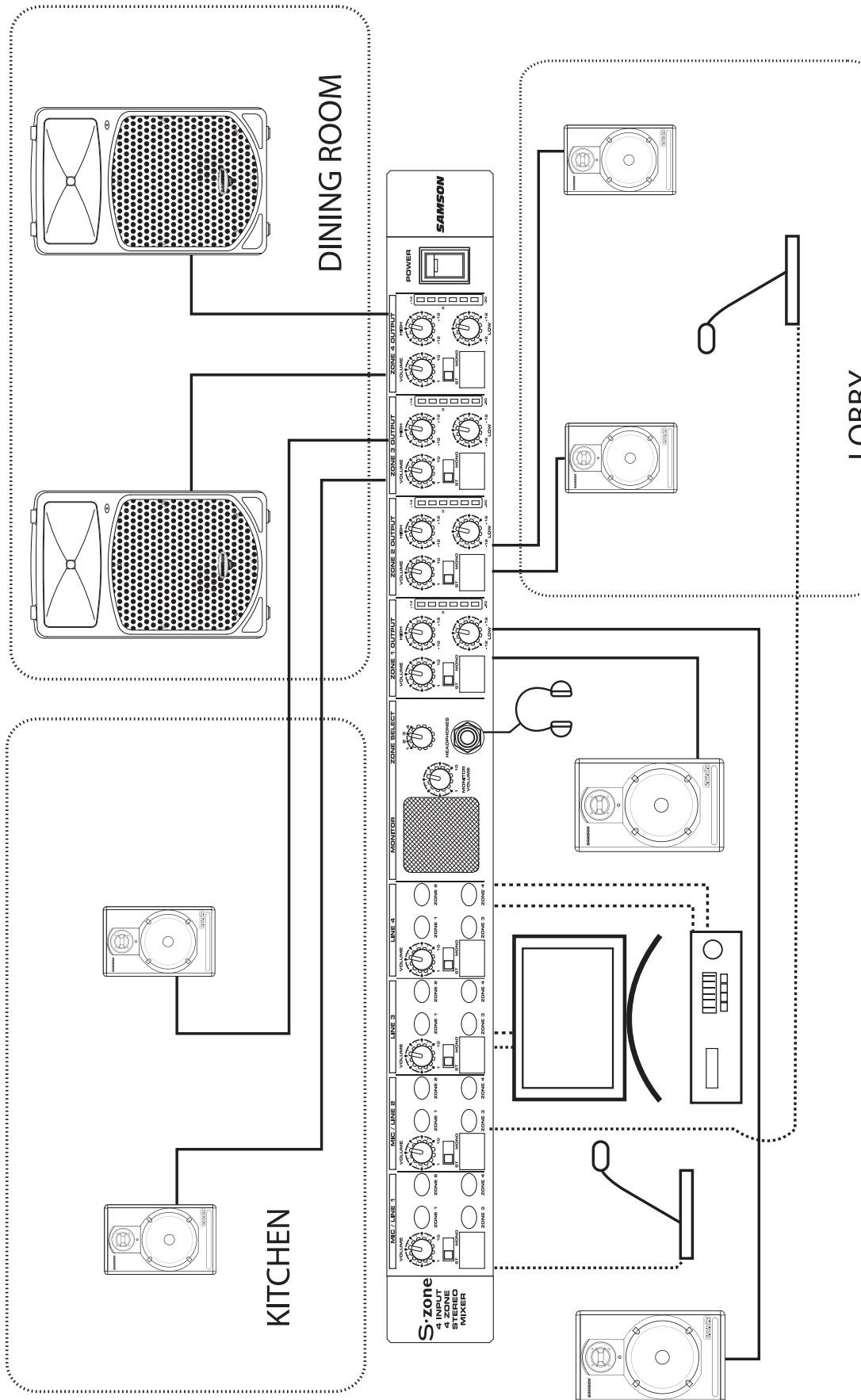

The following example shows a typical installation in a small restaurant using the S zone to distribute audio for multimedia playback in the cocktail lounge, program music playback in the dining room and lobby and paging through the restaurant including the kitchen. For audio sources, a CD player is connected to the channel 4's line input and the audio from the LCD AV monitor is connected to the line input on channel 3. The microphones connected to the S zone channel 1 and 2's input are set to duck the music playing in each of the zones.

S zone Wiring Guide

S zone Wiring Guide

There are several ways to interface the S zone, depending on your exact monitoring set-up. Follow the cable diagrams below for connecting your monitor system.

Mic Input Wiring for Channel 1 and 2

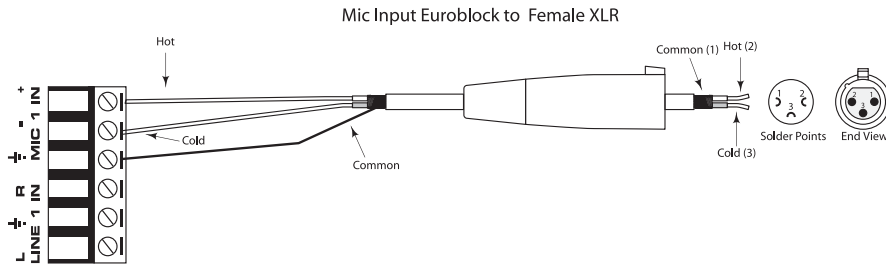

Line Input Wiring for Channel 1 and 2

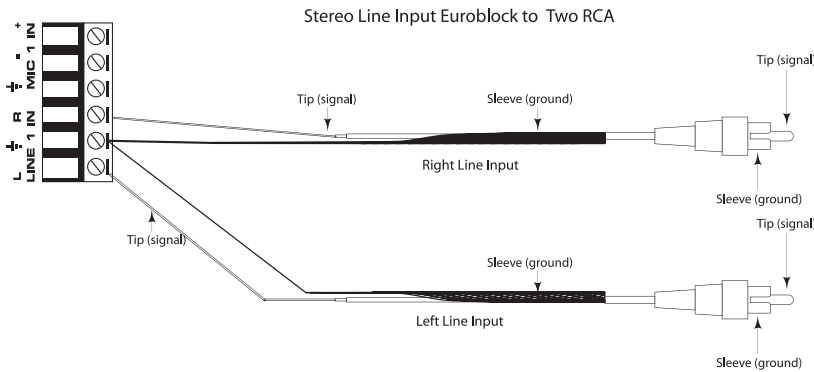

Line Input Wiring for Channel 3 and 4

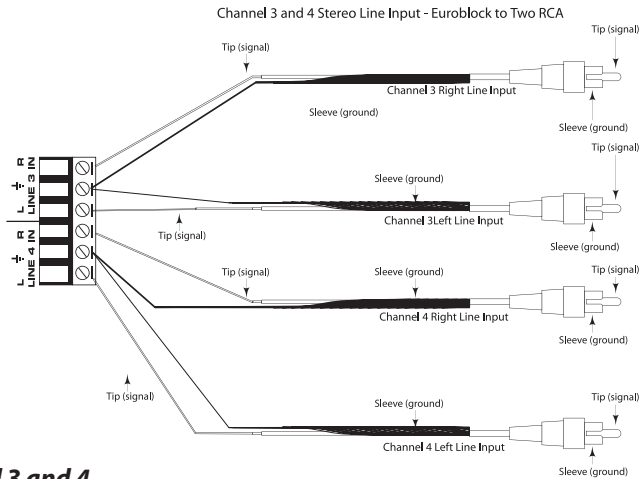

Line Input Wiring for Channel 3 and 4

Zone Output - Balanced Line Euroblock to Male XLR

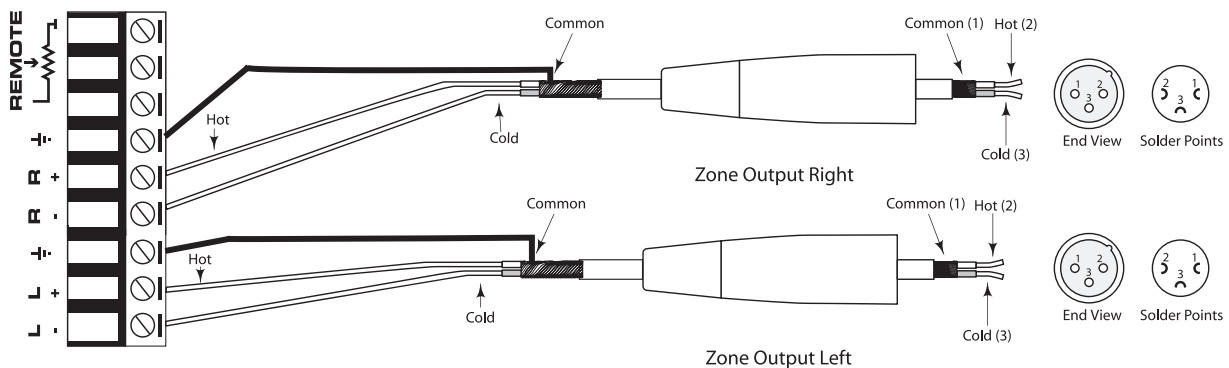

S zone Specifications

S zone Specifications

Input Impedance:	
Mic	600Ω XLR balanced
Line	22K Ω
Max Input Level	
Mic	-14 dBV balanced
Line	+24 dBV
Maximum Gain	
Mic	60 dB
Line	26 dB
Output Level	+17 dBV max.
Output Impedance	
Balanced	200 Ohms
Unbalanced	100 Ohms
Max. S/N ratio	96 dB
THD	<.02%
CMRR:	>52 dB (Mic)
Phantom power	+12 VDC
Tone Controls	
LOW	+/- 15 dB at 100 Hz
HIGH	+/- 15 dB at 10 kHz
Connectors	
Inputs	6 PIN Euroblock
Outputs	9 PIN Euroblock
Power Supply	
Mains Voltages/selectable	USA/Canada ~120 V AC, 60 Hz U.K./Australia ~240 V AC, 50 Hz Europe ~230 V AC, 50 Hz
Fuse	100-120 V AC; 250 mA (slow-blow) 200-240 V AC: 125 mA (slow-blow)
Power Consumption	5 Watts
Power inlet	Standard IEC receptacle with fuse
Dimensions	19 in. (w) x 7.5 (d) x 1.75 (h) 482 mm (w) x 190 (d) x 44 (h)
Weight	5.1 lb. (2.31 kg)

S zone Block Diagram

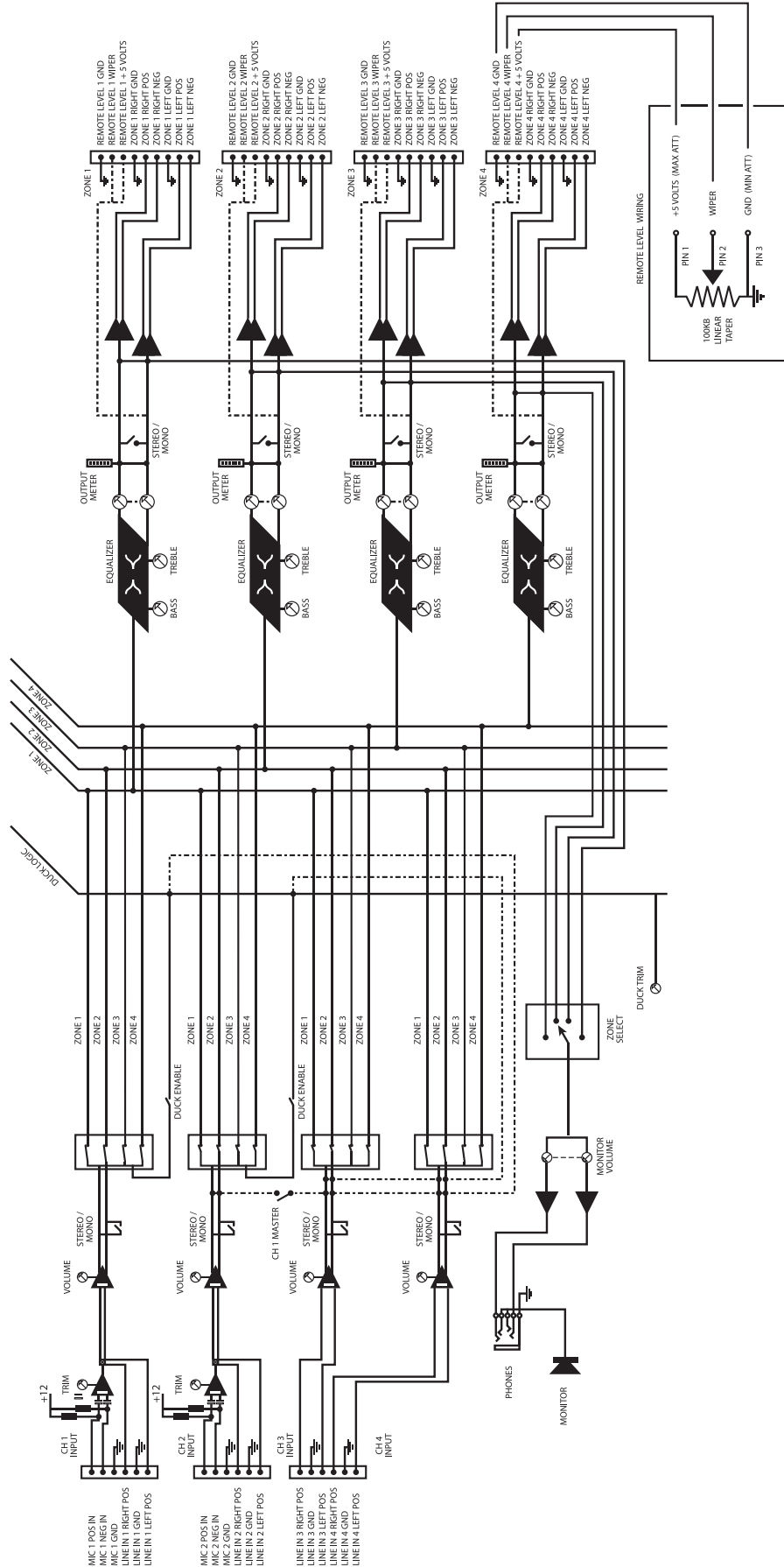

Notes

Notes

Samson Technologies Corp.
575 Underhill Blvd.
P.O. Box 9031
Syosset, NY 11791-9031
Phone: 1-800-3-SAMSON (1-800-372-6766)
Fax: 516-364-3888
www.samsontech.com

Free Manuals Download Website

<http://myh66.com>

<http://usermanuals.us>

<http://www.somanuals.com>

<http://www.4manuals.cc>

<http://www.manual-lib.com>

<http://www.404manual.com>

<http://www.luxmanual.com>

<http://aubethermostatmanual.com>

Golf course search by state

<http://golfingnear.com>

Email search by domain

<http://emailbydomain.com>

Auto manuals search

<http://auto.somanuals.com>

TV manuals search

<http://tv.somanuals.com>