

XM910

24^{BIT}DSP
DIGITAL EFFECTS

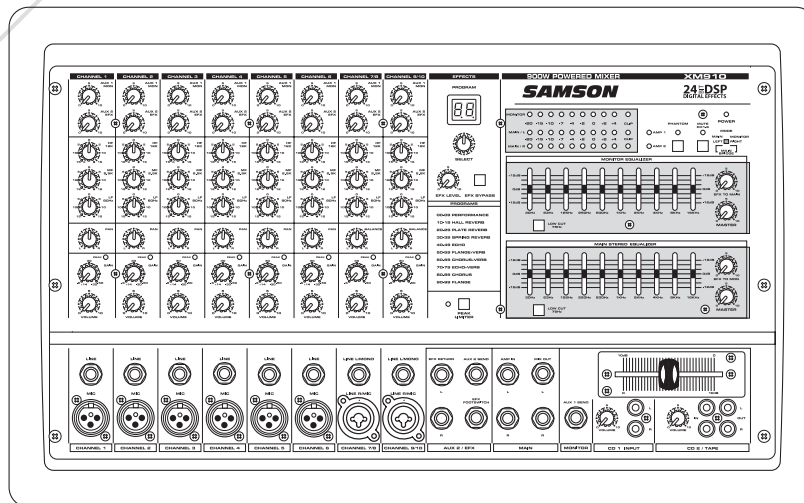

TEN CHANNEL POWERED MIXER
WITH 24BIT DIGITAL EFFECTS

Owners Manual

SAMSON
A U D I O

Powered Mixers



WARNING: To reduce the risk of fire or electric shock, do not expose this unit to rain or moisture. To reduce the hazard of electrical shock, do not remove cover or back. No user serviceable parts inside. Please refer all servicing to qualified personnel. The lightning flash with an arrowhead symbol within an equilateral triangle, is intended to alert the user to the presence of uninsulated "dangerous voltage" within the products enclosure that may be of sufficient magnitude to constitute a risk of electric shock to persons. The exclamation point within an equilateral triangle is intended to alert the user to the presence of important operating and maintenance (servicing) instructions in the literature accompanying the product.

Important Safety Instructions

1. Please read all instructions before operating the unit.
2. Keep these instructions for future reference.
3. Please heed all safety warnings.
4. Follow manufacturers instructions.
5. Do not use this unit near water or moisture.
6. Clean only with a damp cloth.
7. Do not block any of the ventilation openings. Install in accordance with the manufacturers instructions.
8. Do not install near any heat sources such as radiators, heat registers, stoves, or other apparatus (including amplifiers) that produce heat.
9. Do not defeat the safety purpose of the polarized or grounding-type plug. A polarized plug has two blades with one wider than the other. A grounding type plug has two blades and a third grounding prong. The wide blade or third prong is provided for your safety. When the provided plug does not fit your outlet, consult an electrician for replacement of the obsolete outlet.
10. Protect the power cord from being walked on and pinched particularly at plugs, convenience receptacles and at the point at which they exit from the unit.
11. Unplug this unit during lightning storms or when unused for long periods of time.
12. Refer all servicing to qualified personnel. Servicing is required when the unit has been damaged in any way, such as power supply cord or plug damage, or if liquid has been spilled or objects have fallen into the unit, the unit has been exposed to rain or moisture, does not operate normally, or has been dropped.

ACHTUNG: Um die Gefahr eines Brandes oder Stromschlags zu verringern, sollten Sie dieses Gerät weder Regen noch Feuchtigkeit aussetzen. Um die Gefahr eines Stromschlags zu verringern, sollten Sie weder Deckel noch Rückwand des Geräts entfernen. Im Innern befinden sich keine Teile, die vom Anwender gewartet werden können. Überlassen Sie die Wartung qualifiziertem

Fachpersonal. Der Blitz mit Pfeilspitze im gleichseitigen Dreieck soll den Anwender vor nichtisolierter "gefährlicher Spannung" im Geräteinnern warnen. Diese Spannung kann so hoch sein, dass die Gefahr eines Stromschlags besteht. Das Ausrufezeichen im gleichseitigen Dreieck soll den Anwender auf wichtige Bedienungs- und Wartungsanleitungen aufmerksam machen, die im mitgelieferten Informationsmaterial näher beschrieben werden.

Wichtige Sicherheitsvorkehrungen

1. Lesen Sie alle Anleitungen, bevor Sie das Gerät in Betrieb nehmen.
2. Bewahren Sie diese Anleitungen für den späteren Gebrauch gut auf.
3. Bitte treffen Sie alle beschriebenen Sicherheitsvorkehrungen.
4. Befolgen Sie die Anleitungen des Herstellers.
5. Benutzen Sie das Gerät nicht in der Nähe von Wasser oder Feuchtigkeit.
6. Verwenden Sie zur Reinigung des Geräts nur ein feuchtes Tuch.
7. Blockieren Sie keine Belüftungsöffnungen. Nehmen Sie den Einbau des Geräts nur entsprechend den Anweisungen des Herstellers vor.
8. Bauen Sie das Gerät nicht in der Nähe von Wärmequellen wie Heizkörpern, Wärmeklappen, Öfen oder anderen Geräten (inklusive Verstärkern) ein, die Hitze erzeugen.
9. Setzen Sie die Sicherheitsfunktion des polarisierten oder geerdeten Steckers nicht außer Kraft. Ein polarisierter Stecker hat zwei flache, unterschiedlich breite Pole. Ein geerdeter Stecker hat zwei flache Pole und einen drittel Erdungsstift. Der breitere Pol oder der dritte Stift dient Ihrer Sicherheit. Wenn der vorhandene Stecker nicht in Ihre Steckdose passt, lassen Sie die veraltete Steckdose von einem Elektriker ersetzen.
10. Schützen Sie das Netzkabel dahingehend, dass niemand darüber laufen und es nicht geknickt werden kann. Achten Sie hierbei besonders auf Netzstecker, Mehrfachsteckdosen und den Kabelanschluss am Gerät.
11. Ziehen Sie den Netzstecker des Geräts bei Gewittern oder längeren Betriebspausen aus der Steckdose.
12. Überlassen Sie die Wartung qualifiziertem Fachpersonal. Eine Wartung ist notwendig, wenn das Gerät auf irgendeine Weise, beispielsweise am Kabel oder Netzstecker beschädigt wurde, oder wenn Flüssigkeiten oder Objekte in das Gerät gelangt sind, es Regen oder Feuchtigkeit ausgesetzt war, nicht mehr wie gewohnt betrieben werden kann oder fallen gelassen wurde.

ATTENTION: Pour éviter tout risque d'électrocution ou d'incendie, ne pas exposer cet appareil à la pluie ou à l'humidité. Pour éviter tout risque d'électrocution, ne pas ôter le couvercle ou le dos du boîtier. Cet appareil ne contient aucune pièce remplaçable par l'utilisateur. Confiez toutes les réparations à un personnel qualifié. Le signe avec un éclair dans un triangle prévient l'utilisateur de la présence d'une tension dangereuse et non isolée dans l'appareil. Cette tension constitue un risque d'électrocution. Le signe avec un point d'exclamation dans un triangle prévient l'utilisateur d'instructions importantes relatives à l'utilisation et à la maintenance du produit.

Consignes de sécurité importantes

1. Veuillez lire toutes les instructions avant d'utiliser l'appareil.
2. Conserver ces instructions pour toute lecture ultérieure.
3. Lisez avec attention toutes les consignes de sécurité.
4. Suivez les instructions du fabricant.
5. Ne pas utiliser cet appareil près d'une source liquide ou dans un lieu humide.
6. Nettoyez l'appareil uniquement avec un tissu humide.
7. Veillez à ne pas obstruer les fentes prévues pour la ventilation de l'appareil. Installez l'appareil selon les instructions du fabricant.
8. Ne pas installer près d'une source de chaleur (radiateurs, etc.) ou de tout équipement susceptible de générer de la chaleur (amplificateurs de puissance par exemple).
9. Ne pas retirer la terre du cordon secteur ou de la prise murale. Les fiches canadiennes avec polarisation (avec une lame plus large) ne doivent pas être modifiées. Si votre prise murale ne correspond pas au modèle fourni, consultez votre électricien.
10. Protégez le cordon secteur contre tous les dommages possibles (pincement, tension, torsion, etc.). Veillez à ce que le cordon secteur soit libre, en particulier à sa sortie du boîtier.
11. Déconnectez l'appareil du secteur en présence d'orage ou lors de périodes d'inutilisation prolongées.
12. Consultez un service de réparation qualifié pour tout dysfonctionnement (dommage sur le cordon secteur, baisse de performances, exposition à la pluie, projection liquide dans l'appareil, introduction d'un objet dans le boîtier, etc.).

PRECAUCION: Para reducir el riesgo de incendios o descargas, no permita que este aparato quede expuesto a la lluvia o la humedad. Para reducir el riesgo de descarga eléctrica, nunca quite la tapa ni el chasis. Dentro del aparato no hay piezas susceptibles de ser reparadas por el usuario. Dirija cualquier reparación al servicio técnico oficial. El símbolo del relámpago dentro del triángulo equilátero pretende advertir al usuario de la presencia de "voltajes peligrosos" no aislados dentro de la carcasa del producto, que pueden ser de la magnitud suficiente como para constituir un riesgo de descarga eléctrica a las personas. El símbolo de exclamación dentro del triángulo equilátero quiere advertirle de la existencia de importantes instrucciones de manejo y mantenimiento (reparaciones) en los documentos que se adjuntan con este aparato.

Instrucciones importantes de seguridad

1. Lea todo este manual de instrucciones antes de comenzar a usar la unidad.
2. Conserve estas instrucciones para cualquier consulta en el futuro.
3. Cumpla con todo lo indicado en las precauciones de seguridad.
4. Observe y siga todas las instrucciones del fabricante.
5. Nunca utilice este aparato cerca del agua o en lugares húmedos.
6. Limpie este aparato solo con un trapo suave y ligeramente humedecido.
7. No bloquee ninguna de las aberturas de ventilación. Instale este aparato de acuerdo a las instrucciones del fabricante.
8. No instale este aparato cerca de fuentes de calor como radiadores, calentadores, hornos u otros aparatos (incluyendo amplificadores) que produzcan calor.
9. No anule el sistema de seguridad del enchufe de tipo polarizado o con toma de tierra. Un enchufe polarizado tiene dos bornes, uno más ancho que el otro. Uno con toma de tierra tiene dos bornes normales y un tercero para la conexión a tierra. El borne ancho o el tercero se incluyen como medida de seguridad. Cuando el enchufe no encaje en su salida de corriente, llame a un electricista para que le cambie su salida anticuada.
10. Evite que el cable de corriente quede en una posición en la que pueda ser pisado o aplastado, especialmente en los enchufes, receptáculos y en el punto en el que salen de la unidad.
11. Desconecte de la corriente este aparato durante las tormentas eléctricas o cuando no lo vaya a usar durante un periodo de tiempo largo.
12. Dirija cualquier posible reparación solo al servicio técnico oficial. Deberá hacer que su aparato sea reparado cuando esté dañado de alguna forma, como si el cable de corriente o el enchufe están dañados, o si se han derramado líquidos o se ha introducido algún objeto dentro de la unidad, si esta ha quedado expuesta a la lluvia o la humedad, si no funciona normalmente o si ha caído al suelo.

Table of Contents

Introduction	2
XM910 Features	3
Controls and Functions	
Front Panel Layout	4 - 5
Front Panel Controls	6-12
XM910 Input and Output Connections	13–16
Operating the XM910	17–20
System Set-ups	21–22
XM910 Wiring Guide	23
Specifications	24
Block Diagram	25

THIS DEVICE COMPLIES WITH PART 15 OF THE FCC RULES CLASS B. OPERATION IS SUBJECT TO THE FOLLOWING TWO CONDITIONS: (1) THIS DEVICE MUST NOT CAUSE HARMFUL INTERFERENCE, AND (2) THIS DEVICE MUST ACCEPT ANY INTERFERENCE RECEIVED INCLUDING INTERFERENCE THAT MAY CAUSE UNDESIRE OPERATION. SUITABLE FOR HOME OR OFFICE USE.

Copyright 2004, Samson Technologies Corp.

Printed March, 2004

Samson Technologies Corp.
575 Underhill Blvd.
P.O. Box 9031
Syosset, NY 11791-9031
Phone: 1-800-3-SAMSON (1-800-372-6766)
Fax: 516-364-3888
www.samsontech.com

Introduction

Congratulations on your purchase of the Samson XM910 powered mixer! The XM910 is a ten channel, 900 Watt powered mixer with a built-in, 24 BIT DSP (Digital Signal Processor) effects. The XM910 will give you clean, clear sound reproduction thanks to the high quality, low noise microphone preamps, super clean mix bus, two on-board 10-band graphic equalizers and the high output/low distortion power amplifier. For studio quality processing, you can add one of the 100 dazzling digital effects including Delays, Chorus and lush Reverbs to your voice or instruments. The XM910's ingenious Kickback enclosure allows you to tilt the unit back to see, and operate, the controls with ease. The unit is easy to transport with its compact size and oversized, sure-grip handle. The super-tough ABS construction ensures reliable, high quality sound from venue-to-venue and performance-to-performance day in, and night out. Optimized for live sound reinforcement and commercial installations, the XM910 is an ideal mixer and power amp solution offering big sound in a compact package.

In these pages, you'll find a detailed description of the features of the XM910 powered mixer, as well a description of its front and rear panels, step-by-step instructions for its setup and use, and full specifications. You'll also find a warranty card enclosed—please don't forget to fill it out and mail it in so that you can receive online technical support and so we can send you updated information about these and other Samson products in the future.

With proper care and adequate air circulation, your unit will operate trouble free for many years. We recommend you record your serial number in the space provided below for future reference.

Serial number:

Date of purchase:

Should your unit ever require servicing, a Return Authorization number (RA) must be obtained before shipping your unit to Samson. Without this number, the unit will not be accepted. Please call Samson at 1-800-3SAMSON (1-800-372-6766) for a Return Authorization number prior to shipping your unit. Please retain the original packing materials and if possible, return the unit in the original carton and packing materials.

XM910 Features

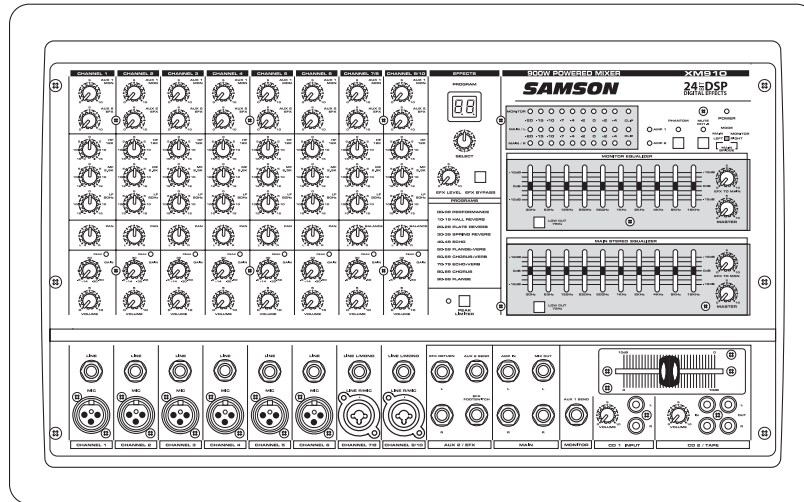

The Samson XM910 Powered Mixer is a comprehensive, all-in-one mixer / power amplifier solution for live sound applications. Here are some of its main features:

- Ten channel powered mixer in ergonomically correct kickback enclosure allowing you to easily see and operate the front panel functions.
- Eight Mic / Line inputs with 1/4-inch phone and XLR connectors.
- 2 x 450 Watts Main, or 450 Watt Main / 450 Watt Monitor, or 900 Watts Bridged power operating modes.
- A built-in, 24-bit DSP (Digital Signal Processor) with 100 selectable presets including Reverb, Delay and Chorus, offers dazzling studio quality effects.
- Dynamic or condenser microphones connect easily to the low noise mic pre-amps with available 48 Volt Phantom Power.
- The 3-Band EQ on each channel enables you to tailor the tonal response for each input.
- * Two Auxiliary sends on each channel for building an independent mix to send to the DSP effects and monitors.
- Dual 10-band Graphic Equalizer for operating in either Stereo Main, or Main / Monitor, allowing the system to be set-up for maximum gain before feedback.
- A convenient Tape / CD Input is provided so you connect a stereo device for accompaniment or background music.
- Brilliant sound quality from the advanced circuit design, utilizing low noise operational amplifiers.
- Durable ABS plastic enclosure is road tough insuring reliable performance from night to night and venue to venue .
- Convenient oversize, sure grip handle make the unit easy to carry.
- Three-year extended warranty.

Front Panel Layout

FRONT PANEL LAYOUT

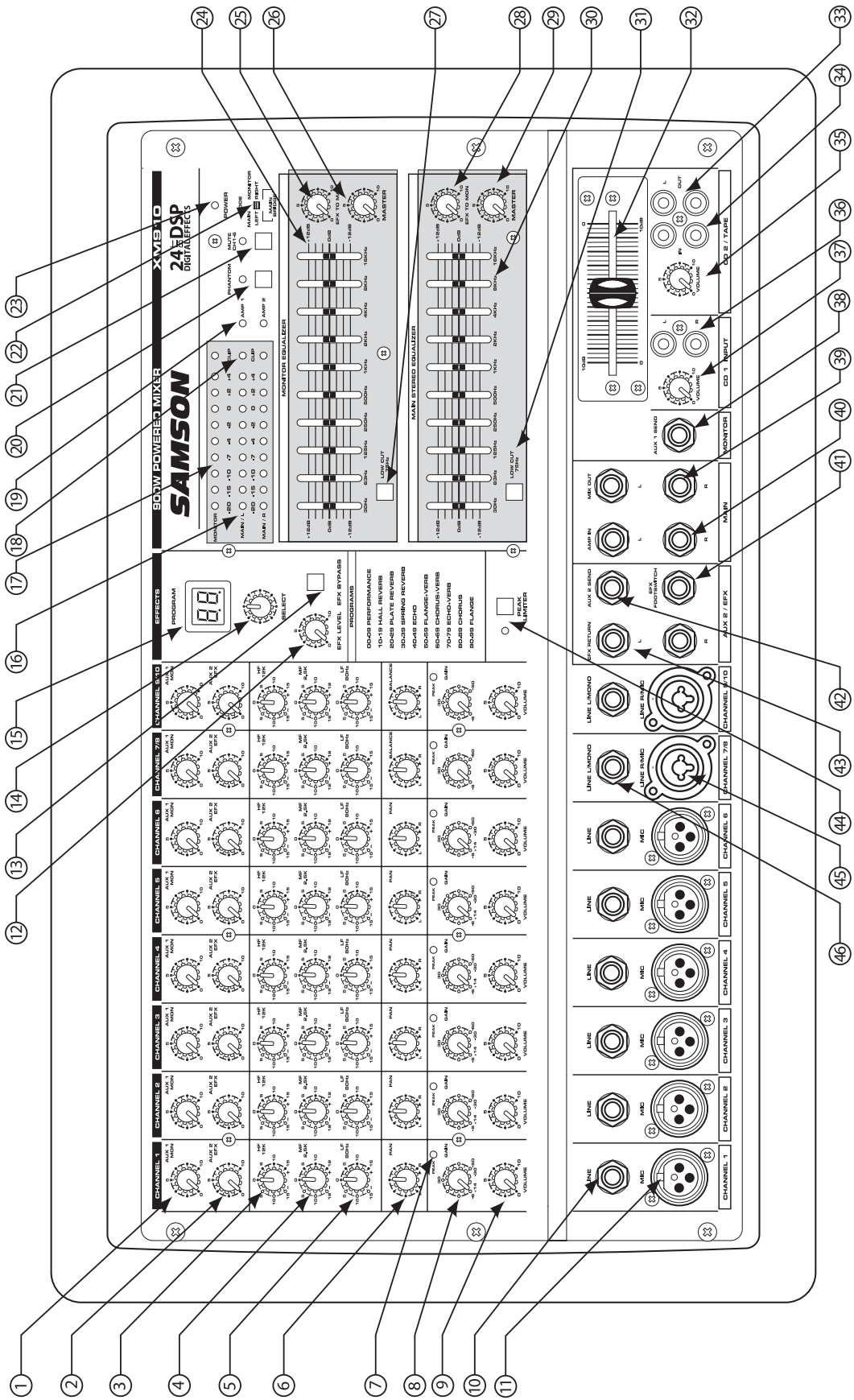

Front Panel Layout

FRONT PANEL

- 1 **AUX 1 MONITOR** – Controls the amount of signal sent to the monitor amp and AUX 1 send jack.
- 2 **AUX 2/EFX** – Controls the amount of signal sent to the digital effects processor and AUX 2 send jack.
- 3 **HIGH FREQUENCY** – Controls the amount of treble applied to that channel.
- 4 **MID FREQUENCY** – Controls the amount of midrange applied to that channel.
- 5 **LOW FREQUENCY** – Controls the amount of bass applied to that channel.
- 6 **PAN (Balance on stereo channels)** – Adjusts the amount of signal sent to the Left or Right bus.
- 7 **PEAK LED** – Indicates that the signal is peaking or overloading.
- 8 **GAIN** – Sets the overall level for the Mic or Line input.
- 9 **VOLUME** – Controls the overall volume of that channel.
- 10 **LINE INPUT** – Balanced input for line level signals.
- 11 **MIC INPUT** – Input connector for low impedance balanced microphone input.
- 12 **EFX LEVEL** – Master control for the amount of signal sent to the DSP and AUX 2 Send.
- 13 **EFX BYPASS** – Shuts off the internal DSP.
- 14 **SELECT** – Selects one of the 100 digital effects presets available.
- 15 **EFX PROGRAM DISPLAY** – Show the current DSP effect pre-set.
- 16 **MAIN LED METERS** – Indicates the amount of output signal on the main stereo output.
- 17 **MONITOR LED METER** – Indicates the amount of output signal on the monitor output.
- 18 **CLIP LEDS** – Indicates power amp maximum level.
- 19 **AMP 1 and AMP 2 PROTECT LEDS** – Indicates power amp is in overload and that the protect circuit is active.
- 20 **PHANTOM POWER** – Provides 48 volts to the XLR inputs for powering condenser microphones.
- 21 **MUTE CH 1 - 6 SWITCH** – Used to turn off the inputs of channel 1 through 6.
- 22 **MODE SWITCH** – Configures the output of the power amps. Stereo or Main/Monitor 450W X 2 (4 ohms), Main Bridged 600W X 1 (8 ohms).
- 23 **POWER LED** – Indicates status of the power switch On/Off.
- 24 **MONITOR GRAPHIC EQ** – Provides dual 10-Band equalization for the channel monitor.
- 25 **EFX TO MON** – Effects return control for monitor channel.
- 26 **MASTER (MONITOR)** – Master volume control for monitor amp and AUX 1 Send.
- 27 **LOW CUT (MONITOR)** – Used to attenuate the low frequencies below 75 Hz on the monitor output.
- 28 **EFX RETURN (MAIN)** – Effects return control for main channel.
- 29 **MASTER** – Master volume control for main stereo/mono amp and main mix out L/R.
- 30 **MAIN GRAPHIC EQ** – Provides dual 10-Band equalization for the channel monitor.
- 31 **LOW CUT (MAIN)** – Used to attenuate the low frequencies below 75 Hz on the main output.
- 32 **DJ CROSSFADER** – Used to mix between the CD1 and CD2 inputs.
- 33 **REC OUT** – Output used to send main mix to an external recorder.
- 34 **CD2 INPUT** – Used to connect input from a CD/MD/Tape Deck.
- 35 **CD2 INPUT VOLUME** – Controls the amount of volume from an external line source like CD, MP3 or Tape.
- 36 **CD1 INPUT** – Used to connect input from a CD/MD/Tape Deck.
- 37 **CD1 INPUT VOLUME** – Controls the amount of volume from an external line source like CD, MP3 or Tape.
- 38 **AUX 1 SEND** – Monitor signal output connector.
- 39 **MIX OUT** – Left and Right output jacks for the main mix output pre amp signal.
- 40 **AMP IN** – Left and Right input jacks for connecting directly to the internal power amplifier.
- 41 **EFX FOOTSWITCH** – Switches the effects on or off.
- 42 **AUX 2 SEND** – Effects output jack for connecting an external effects processor.
- 43 **EFX RETURN** – Left and Right input connectors for mixing external signals.
- 44 **PEAK LIMITER SWITCH** – Use to engage the internal Peak Limiter.
- 45 **LINE / MIC INPUT (Stereo Channels)** – Combination connector with 1/4-inch TRS (TIP RING SLEEVE) input to the right line input, plus XLR mic input.
- 45 **LINE L INPUT (Stereo Channels)** – 1/4-inch TRS (TIP RING SLEEVE) input to the left line input.

Controls and Functions

MONO INPUT CHANNEL SECTION

The following section details each part of the XM910's INPUT CHANNELS including the 3-BAND EQ, the MONITOR and EFX sends, PAN, GAIN and VOLUME controls.

1 AUX 1/MON - Monitor Send

Each of the XM910's channels include a MONITOR send which controls the amount of that channel's signal that is sent to the MONITOR bus. The Input channel's MONITOR sends are mixed together and are sent to the speakers connected to the POWER AMP 1 A/B jacks if the POWER AMP select switch is set to MAIN+MONITOR.

2 AUX 2 / EFX Effects Send

The XM910 provides high quality, 24 Bit digital effects, and the level of effects can be set independently on each channel. The channel's EFX (Effects) knob controls the amount of signal that is sent to the EFX bus. The signal of the EFX bus is routed to the DSP EFX section for on-board signal processing. The EFX signal can also be sent to an external effect device connected to the AUX 2 SEND jack located on the front panel.

NOTE: The channel's EFX signal is sent to the EFX bus from a location in the signal path after the VOLUME control (7). This is commonly referred as a POST FADER send. This means that the amount of signal that is sent to the EFFECT bus will be affected not only by the setting of the EFX knob control, but it will also be affected by the setting of the VOLUME control.

3 HIGH MID LOW - Channel Equalizer

The XM910 input channels feature a 3-band equalizer allowing you to adjust the high, mid, and low frequencies independently on each channel. The channel's frequency response is flat when the knobs are in the "12:00" position. Rotating the knob towards the right will boost the corresponding frequency band by 12dB/15dB, and rotating it towards the left will cut the frequency by 12dB/15dB. The frequency centers, range of boost or cut, and equalizer type for each band are as follows:

High: 12KHz +/- 15dB shelving type

Mid: 2.5KHz +/- 12dB peaking type

Low: 80Hz +/- 15dB shelving type

4 PAN - Control

The XM910's PAN control is used to place or position the mono signal into the stereo main Left and Right MIX bus. You can create a stereo image by panning some input signals to the left and others to the right. The XM910's PAN control is a Power-Pan circuit, which includes a 3dB dip in the center position. This is desirable since there's a 3dB increase in gain when the mono input signal is heard in both the Left and Right MIX bus.

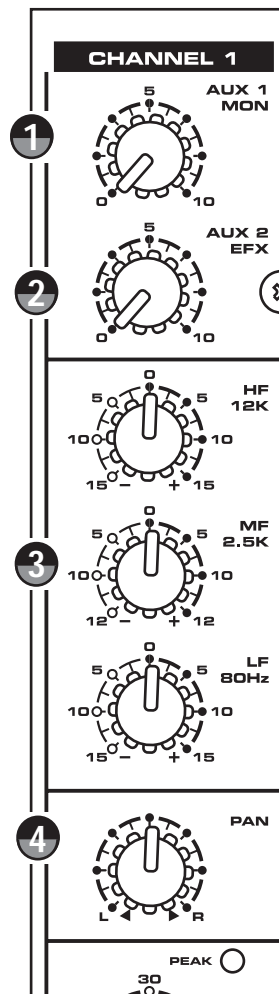

Controls and Functions

MONO INPUT CHANNEL SECTION - continued

5 PEAK LED

The XM910's MIC/LINE pre-amp also includes a PEAK LED which, when illuminated, indicates that the signal is peaking or overloading. To reduce distortion, lower the GAIN control to keep this LED from staying on.

6 GAIN - Control

The XM910's pre-amp stage has a variable GAIN control with a range of -6 to -50dB on the MIC input and +14 to -30dB on the LINE input.

7 VOLUME - Level Control

The VOLUME control adjusts the output volume of each channel.

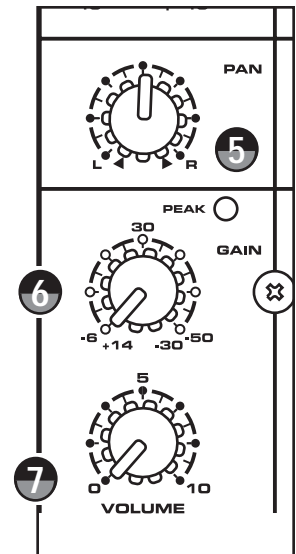

STEREO INPUT CHANNEL SECTION

The XM910 features two stereo input strips, which include channels 7/8 and 9/10. While these channels look very much like the mono channels, they have two inputs so they can accept a stereo signal. The AUX send and Equalizer are laid out on the same as the mono inputs on the control panel, but internally, they are controlling a stereo signal path. As an added bonus, these inputs also include a microphone input, which can be used in mono. There are two differences in the stereo channel controls, the Balance control and Gain. These controls are detailed in the following section.

8 BALANCE (Stereo Inputs Only)

The MDR1064's BALANCE control is used to place or position the stereo signal into the main Left and Right MIX bus. You can move a stereo signal's image to the left or right by setting the BALANCE control to the left or to the right.

9 GAIN - Control (Stereo Inputs Only)

The XM910's pre-amp stage has a variable GAIN control with a range of -6 to -50dB on the MIC input and +14 to -30dB on the LINE input.

10 VOLUME - Level Control

The VOLUME control adjusts the output volume of each channel.

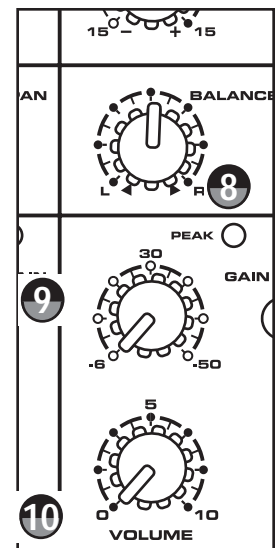

Controls and Functions

FRONT PANEL CONTROLS

24 BIT DIGITAL EFFECT SECTION

The XM910 features a built-in, 24 Bit Digital Effects processor with 100 high quality, studio grade effects like Delay, Chorus and Reverb. The following section describes the features of the powerful on-board digital effects section.

10 SELECT - Digital Effects Select Switch

The SELECT switch allows you to pick one of the 100 built-in digital effects. Simply rotate the SELECT to choose the effect.

11 Program - Effects Display

The XM910 features a dual, digital, seven segment numerical display for showing the effects program number. You will see the PROGRAM numbers change as you use the DSP SELECT control to change the effects pre-set.

12 Effect PROGRAM List

This section identifies the ten banks of built-in DSP effects presets. The first bank of 10 presets are designed for live performance, and the following banks are set up in groups by the types of effects.

13 EFX LEVEL - Master Effect Send

The EFX LEVEL control is used to send the effect mix bus to an external effect device connected to the AUX 2 SEND jack.

14 EFX BYPASS - switch

The EFX BYPASS switch is used to turn the internal Digital Effect on and off. The effects are by-passed when the switch is in the in position and the display shows two dashes.

15 PEAK LIMITER - Switch

In order to keep the sound loud and clean, the XM910 incorporates an on-board Limiter dynamic processor. When you press the LIMITER switch in, the red LED will illuminate indicating that the dynamics processing is engaged.

IMPORTANT NOTE: Unless you are using an external limiter, it is highly recommended that the LIMITER switch be engaged at all times. This will ensure the cleanest possible output, and will protect your speaker system when it accidentally receives a clipped signal from your mixer.

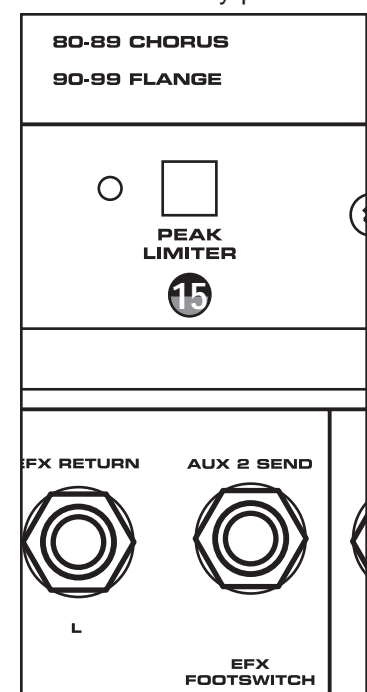
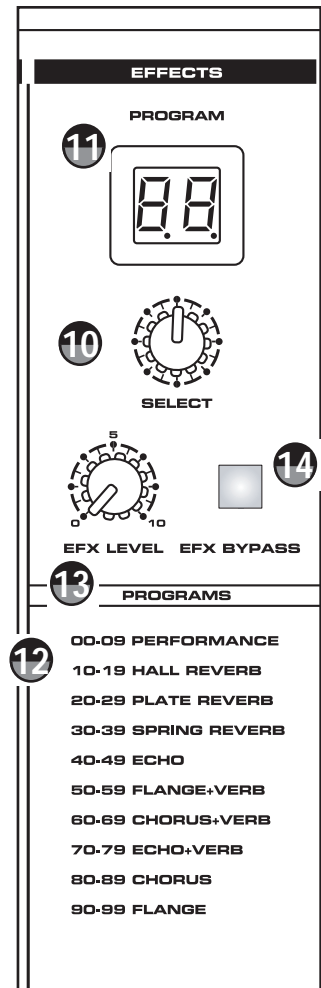

Controls and Functions

POWER AMP SECTION

The XM910's power amplifier section can be configured to operate several ways depending on whether you need MAIN plus MONITOR amplifiers to power your speakers, or if you just need more power for the MAIN speakers. The section below describes the XM910 power amp modes.

16 Mode-Power amp Mode switch

The MODE switch is used to select one of three different operating modes, MAIN-MONITOR, MAIN-MAIN and MAIN-BRIDGE. The following is a description of each of the POWER operating modes:

CAUTION! Only change the power amp mode switch when the XM910's power is SWITCHED OFF!

MAIN-MONITOR

With this setting, the MAIN and MONITOR sections can be used independently. The MAIN bus signal will be sent from the POWER AMP 2 A/B jacks, and the MONITOR bus signal will be sent from the POWER AMP 1 A/B jacks.

MAIN-MAIN

With this setting, the two power amp channels can be used independently. The MAIN bus signal will be output from the POWER AMP 2 A/B jacks (Rear Panel), and also, from the POWER AMP 1 A/B jacks .

MAIN-BRIDGE

With this setting, the two power amp channels (1 and 2) will be connected in bridge mode. Only the MAIN bus signal will be output from the BRIDGE jack.

17 Phantom Power - Switch

The XM910 features an onboard, 48-Volt Phantom power supply to operate condenser microphones. When the switch is engaged, the LED will illuminate indicating that phantom power is now available on the microphone pre-amps.

IMPORTANT NOTE: To avoid a loud pop, be sure to turn down the MASTER level controls before plugging and unplugging the mic cables when the phantom power is active.

18 Mute CH 1 - 6 - Switch

You can turn off channels one through six with a press of a single button using the MUTE CH 1 – 6 switch. This is especially convenient when you take a break and want to leave all the levels set so they are ready when you begin to use your PA system again. The MUTE 1-6 does not turn off channels 7/8 and 9/10, and does not turn off the CD/TAPE inputs. So, when the MUTE CH 1 – 6 switch is on, you still have a 2 channel DJ mixer with two available mic inputs.

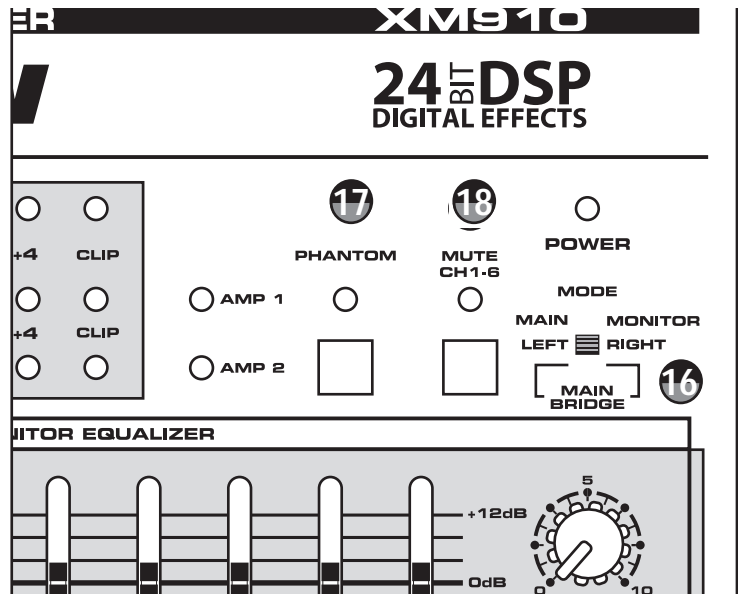

Controls and Functions

MAIN OUTPUT SECTION

The XM910 has two internal power amplifiers and depending on the power amp MODE selection switch, the amplifiers are sent the MAIN or MONITOR bus signal. The following section describes the MAIN bus operation, which allows you to adjust the over-all tone and volume, and specify the mix level of the built-in effects.

19 Output Level Meter

The OUTPUT LEVEL METER allows you to monitor the level of the signal which is being sent to the MIX OUT jacks.

NOTE: To avoid distortion, adjust the MASTER LEVEL control so that the 0 indicator LED lights occasionally.

20 MASTER - Volume Control

The MASTER level control is the over-all volume control for the MAIN bus. The MAIN level affects both the MAIN bus signal which is output to the speakers and the line level signal which is output from the MIX OUT jacks.

21 EFX TO MAIN - Effects Return Control

The EFX TO MAIN control is used to adjust the level of the effect sound being sent back from the built-in digital effect to the MAIN mix bus. This allows you to hear the DSP effects in your MAIN speakers.

22 Graphic Equalizer

The XM910's 10-band stereo Graphic Equalizer allows you to contour the frequency response of the MAIN / MONO mix bus signal, providing a maximum of 12dB of cut/boost for each frequency band. This is an especially useful tool for cutting frequencies that cause annoying feedback. The frequency response is flat when the sliders are in the center position. Moving a slider in the positive direction will boost that frequency by as much as 12dB, and moving the slider in the negative direction will cut that frequency by up to 12dB. Once you set a response curve using the Graphic Equalizer, the EQ curve is applied to both the MAIN / MONO bus signal that is output to the speakers, and the line level signal which is output from the MIX OUT jacks.

23 Low Cut - switch

The MAIN / MONO output of the XM910 includes a LOW CUT (or high pass) filter which rolls off the low frequencies from 75Hz and below at the rate of 18dB per octave. The LOW CUT filter allows you to remove the lower frequencies that you sometime just don't want to pick up. For example, when you are using the XM910 mostly for vocals, you may not want to pick up the low end generated by other live instruments like bass and low-end synthesizers played out of back-line amplifiers on stage. In many live sound applications, the LOW CUT filter is especially useful for removing stage rumble.

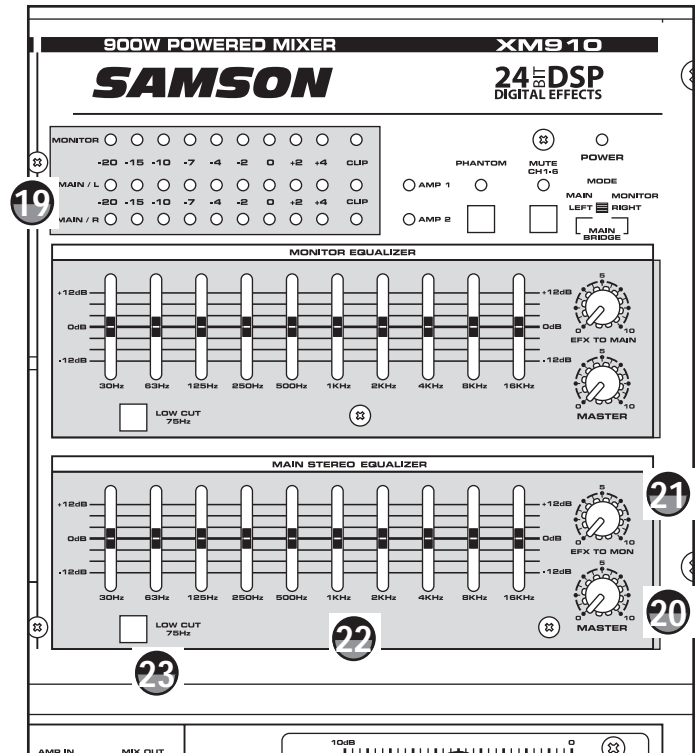

MONITOR SECTION

The XM910 has two internal power amplifiers and depending on the MODE selection switch, the amplifiers received their input signals from the MAIN or MONITOR bus. The following section describes the MONITOR bus operation, which allows you to adjust the overall tone and volume, and specify the mix level of the built-in effects.

24 EFX TO MON - Effects Return Control

The EFX TO MON control is used to adjust the level of the effect sound being sent back from the built-in digital effect to the MONITOR bus. This allows you to hear the DSP effects in your monitor speakers.

25 MASTER - Volume Control

The MASTER level control is the overall control for the MONITOR bus. The MONITOR level affects both the MONITOR bus signal which is sent to the monitor speakers and the line level signal which is sent from the AUX 1 SEND jack.

26 Output Level Meter

The OUTPUT LEVEL METER allows you to monitor the level of the signal which is being sent to the AUX 1 SEND jack and MONITOR POWER AMPLIFIER.

NOTE: To avoid distortion, adjust the MASTER level control so that the 0 indicator LED lights occasionally.

27 Graphic Equalizer

The XM910's 10-band Graphic Equalizer allows you to contour the frequency response of the MONITOR bus signal, providing a maximum of 12dB of cut/boost for each frequency band. This is an especially useful tool for cutting frequencies that cause annoying feedback. The frequency response is flat when the sliders are in the center position. Moving a slider in the positive direction will boost that frequency by as much as 12dB, and moving the slider in the negative direction will cut that frequency by up to 12dB. Once you set a frequency response curve using the Graphic Equalizer, the EQ curve is applied to both the MONITOR bus signal that is sent to the monitor speakers, and the line level signal which is sent from the AUX 1 SEND jack.

28 Low Cut - switch

The MASTER / MONO output of the XM910's includes a LOW CUT (or high pass) filter which rolls off the low frequencies from 75Hz and below at the rate of 18dB per octave. The LOW CUT filter allows you to remove the lower frequencies that you sometime just don't want to pick up. For example, when you are using the XM910 mostly for vocals, you may not want to pick up the low end generated by other live instruments like bass and low-end synthesizers played out of back-line amplifiers on stage. In many live sound applications, the LOW CUT filter is especially useful for removing stage rumble.

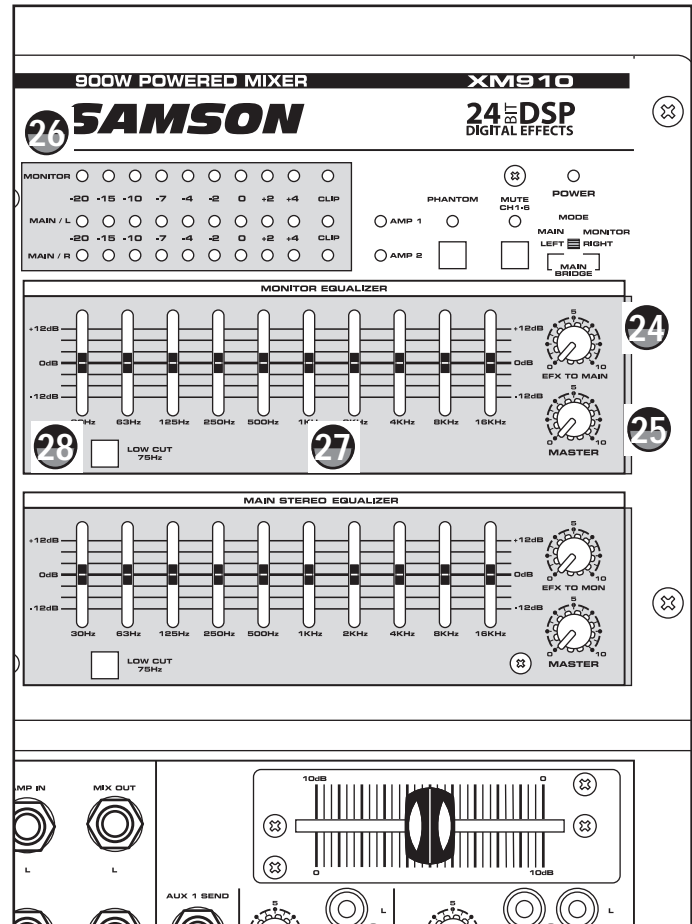

Controls and Functions

DJ MIXER SECTION

Offering extreme flexibility for today's working musicians, the XM910 incorporates an on-board, two channel stereo DJ mixer. The following section details the control functions used in the XM910's DJ mixers section.

29 DJ Crossfader

The XM910 has a built-in DJ mixer, which can be used to mix line level sources like CD or tape players. Like other high quality DJ mixers, the XM910 has a removable crossfader featuring a smooth linear taper. The Crossfader is used to mix between the CD1 input and the CD/TAPE 2.

30 CD 1 – Input Level Control

The CD 1 input volume control is used to adjust the volume of the signal connected to the CD 1 input. When using the DJ mixer, or for just playing back a signal from a CD, MP3 player, cassette tape or other stereo device like DVD or VCR or computer sound card output, use the CD 1 level control to set the perfect level. Be sure to set the DJ crossfader all the way to the left side.

31 CD 2 – Input Level Control

The CD 2 input volume control is used to adjust the volume of the signal connected to the CD 2 input. When using the DJ mixer, or for just playing back a signal from a CD, MP3 player, cassette tape or other stereo device like DVD or VCR or computer sound card output, use the CD 2 level control to set the perfect level. Be sure to set the DJ crossfader all the way to the right side.

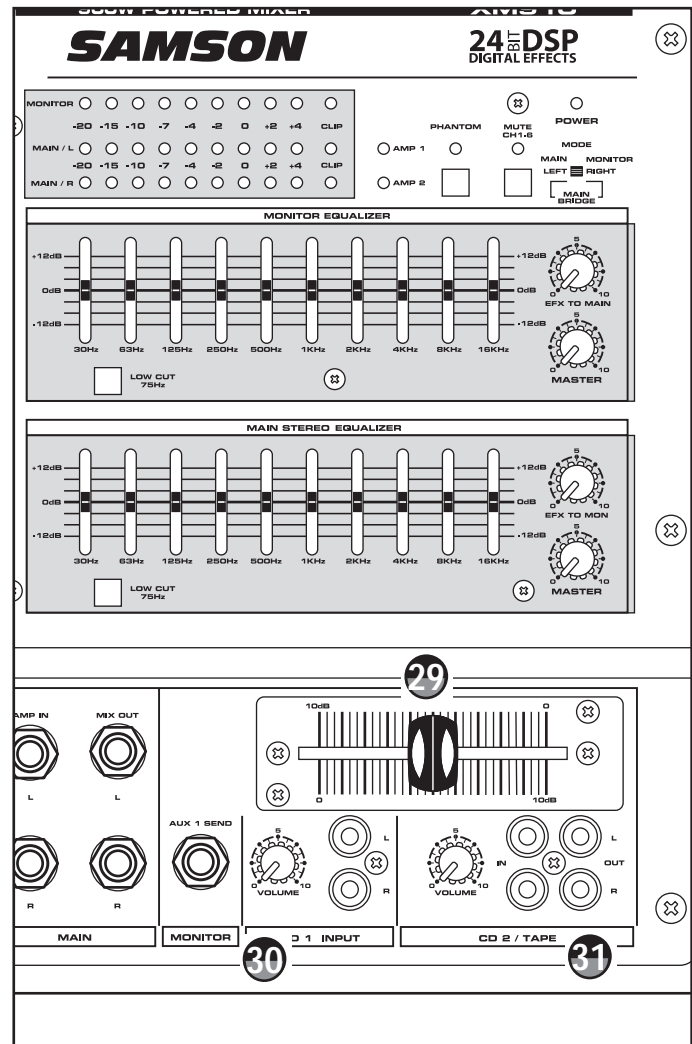

XM910 Input and Output Connections

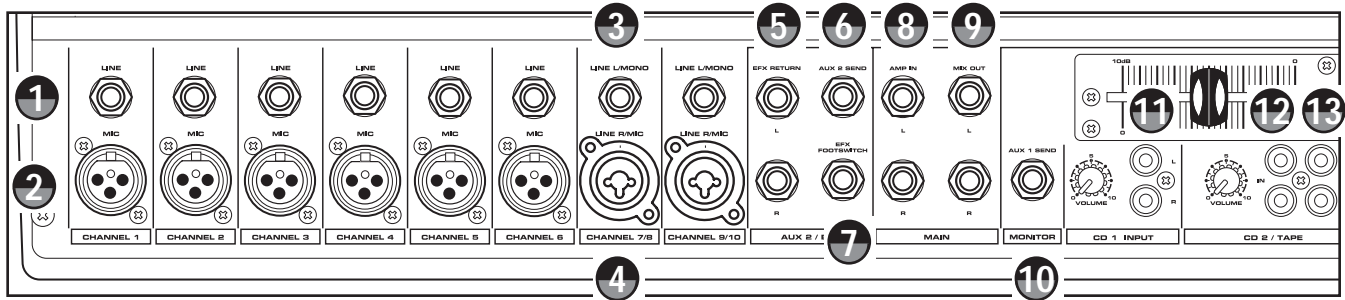

CHANNEL 1– 10 MIC and LINE INPUTS

The XM910's six input channels each have a LINE level, Hi-Z (High Impedance) input and a MIC level, Low-Z (Low impedance) input. By using the GAIN control, you can connect a variety of signal sources from microphones to line level devices such as synthesizers, drum machines and direct boxes. Both LINE and MIC inputs are balanced, with MIC inputs compatible with microphones of output impedance 50-600 Ohms and LINE inputs compatible with line level devices of 600 Ohms.

NOTE: It is not possible to simultaneously use both the LINE and MIC inputs on the same channel. For each channel, use only one of the inputs as appropriate for the input source.

1 LINE - Line Level Input

Use these inputs to connect high impedance microphones, synthesizers and drum machines. The LINE inputs have a nominal operating level of -40dBV through -10dBV.

TRS phone jacks Connector pin-out - Sleeve: Ground, Tip: Hot (+), Ring: Cold (-)

2 MIC - Microphone Input

Use these inputs to connect Low Impedance microphones and low level signals from direct boxes. The MIC inputs have a nominal operating level of -50dBV through -20dBV. The MIC inputs also feature +48V phantom power, allowing you to use condenser microphones. The Phantom Power is switched on/off simultaneously for channels 1 through 6.

XLR Connector pin-out - Pin 1: Ground, Pin 2: Hot (+), Pin 3: Cold (-)

3 LINE L / MONO – Left Line Input (Stereo channels only)

Channel 7/8 and 9/10 can accept either stereo or mono inputs. For stereo connections, use the LINE L / MONO to connect the left channel. If you are using the inputs for a mono line input, use the LINE L / Mono input only so that the signal feeds both the right and left mix bus. Use these inputs to connect high impedance microphones, synthesizers and drum machines. The LINE inputs have a nominal operating level of -40dBV through -10dBV.

TRS phone jacks Connector pin-out - Sleeve: Ground, Tip: Hot (+), Ring: Cold (-)

4 LINE R / MIC - Right Line and Microphone Combination Input (Stereo channels only)

For the right inputs of the stereo channels, the XM910 incorporates a “combo” connector, which can accept either an XLR or 1/4-inch connector. These stereo inputs includes an extra mic pre which you can use to connect Low Impedance microphones and low level signals from direct boxes. The MIC inputs also feature +48V phantom power, allowing you to use condenser microphones. When connecting a stereo signal, use the 1/4-inch phone jack located in the center of the combo connector to connect the right line input.

XLR Connector pin-out - Pin 1: Ground, Pin 2: Hot (+), Pin 3: Cold (-)

TRS phone jacks Connector pin-out - Sleeve: Ground, Tip: Hot (+), Ring: Cold (-)

XM910 Input and Output Connections

MASTER SECTION INPUT AND OUTPUT CONNECTORS

The XM910 features several output connectors allowing you to interface a variety of external devices. A stereo recording device such as a cassette recorder can be connected to the REC OUT jacks, and additional power amplifiers can be connected to the MONITOR and MAIN output jacks.

5 EFX RETURN - Left and Right Auxiliary Input

These two 1/4-inch phone jacks are used to connect the outputs of stereo devices such as external effects processors.

6 AUX 2 SEND - Effects Output

The AUX 2 SEND output is used to interface an external signal processor like a delay or reverb. The signal present at the AUX 2 SEND output is sent from the EFFECTS bus, which is fed from the AUX 2/ EFX send on the input channels and the EFX LEVEL send in the Effects section.

7 EFX FOOTSWITCH - Footswitch Jack

With a footswitch connected to this jack, you can turn on and off the on-board digital effects by simply stepping on the footswitch.

8 AMP IN - Power Amplifier Left and Right Inputs

The Left and Right AMP IN 1/4-inch phone jacks are used to make a direct connection to the XM910's internal power amplifiers. You can connect a stereo source like the output from an external mixer here. In addition, the Left and Right AMP IN jacks can be used combination with the MAIN Left and Right Output jacks to create an effects loop when connecting an external signal processor to effect the entire system. For more information on using the AMP IN connectors as an effects loop, see the section, on page 19 of this manual.

9 MIX OUT - Line Level Left and Right Main Outputs

The signal present at this connector is the MAIN bus signal, which has passed through the MAIN/ MASTER level control and the graphic equalizer. The nominal output level is +4dBu and the impedance is 100 Ohms. In addition, the Left and Right AMP IN jacks can be used combination with the MAIN Left and Right Output jacks to create an effects loop when connecting an external signal processor to effect the entire system. For more information on using the AMP IN connectors as an effects loop, see the section, on page 19 of this manual.

10 AUX 1 SEND - Monitor Output

The MONITOR bus signal is present at this connector. The signal is passed through the MONITOR /MASTER level control and graphic equalizer before it reaches the AUX 1 SEND connector. The nominal output level is +4dBu and the impedance is 100 Ohms.

11 CD 1 IN - Line Level CD/TAPE Input

Used to connect a stereo output device such as cassette recorder or CD player.

12 CD 2 IN - Line Level CD/TAPE Input

Used to connect a stereo output device such as cassette recorder or CD player.

13 REC OUT - Record Output

The signal present at this connector is the MAIN bus signal before it has passed through the MASTER level control and graphic equalizer. The nominal output level is -10dBV and the impedance is 100 Ohms.

XM910 Input and Output Connections

REAR PANEL

The XM910 contains two mono power amplifiers and depending on the operating mode, the two amplifiers can be used independently (maximum output 300W + 300W) or in BRIDGE mode (maximum output 900W).

NOTE: Use the MODE switch to select which signal is sent to the speaker output jacks, and to activate BRIDGE mode.

If the two power amplifiers are used for MAINS operation, two speakers can be connected to the AMP 1 A/B jacks and two more to the AMP 2 A/B jacks, for a total of four speakers.

NOTE: When using the A and B jacks simultaneously, connect 8 through 16 Ohm speakers. In this case, be careful not to connect a speaker to the BRIDGE jack.

The total impedance load for each amplifier must not exceed 4 Ohms, therefore in the example above, one speaker with an impedance of 8 ohms is connected to each amp's A and B jacks. (The A/B jacks are wired in "Parallel", so the total impedance when two 8 Ohm speakers are connected is 4 Ohms.)

If you wish to use two amplifiers independently, let's say for Main and Monitor operation, but only connect a single speaker to the A or B jack, use a 4 through 8 Ohm speaker. Again, the total impedance load for each amplifier must not exceed 4 Ohms, therefore one speaker with an impedance of 8 ohms can be connected to each amp's A and B jacks.

If the two amplifiers are used in a BRIDGE mode, only one speaker can be connected to the BRIDGE jack. The total impedance load while operating in Bridge mode must not be less than 8 Ohms.

If you are connecting a speaker to the BRIDGE jack, use an 8 through 16 Ohm speaker.

CAUTION: When using a bridge connection, do not connect anything to the AMP 1 and AMP 2 jacks. Likewise, when using the POWER AMP 1 and POWER AMP 2 jacks, do not connect anything to the BRIDGE jack.

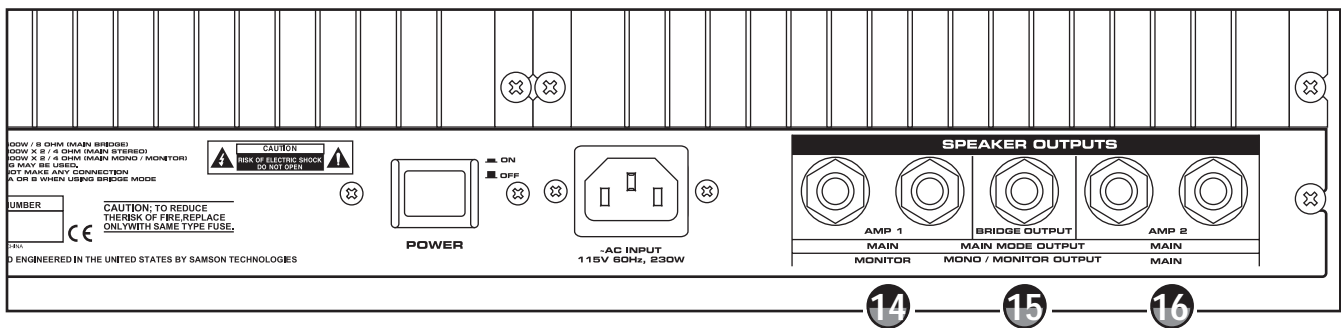

14 AMP 1 – Powered Speaker Outputs

The AMP 1 output has two 1/4-inch phone connectors, which are powered outputs used to connect your left side main PA speaker when using the XM910 in stereo mode. When operating in MAIN / MONITOR mode the AMP 1 powered output connectors are used to connect to floor or side fill monitors facing the performers.

15 BRIDGE – Mono Output connector

The BRIDGE output has one 1/4-inch phone connector, which is a powered output used to connect one main PA speaker when using the XM910 in mono BRIDGE mode.

16 AMP 2– Powered Speaker Outputs

The AMP 2 output has two 1/4-inch phone connectors, which are powered outputs used to connect your right side main PA speaker when using the XM910 in stereo mode. When operating in MAIN / MONITOR mode, the AMP 2 powered output connectors are used to connect left and right side MAIN PA speakers.

XM910 Input and Output Connections

SPEAKER CONNECTION

The XM910's power amplifier section can be configured to operate several ways depending on the setting of the power amp MODE switch located on the front panel. This allows you to choose whether you need MAIN plus MONITOR amplifiers to power your speakers, or if you just need more power for the MAIN speakers. *For more information on the power amp MODE switch, see the section POWER AMP SECTION on page 9 of this manual.*

There are three ways in which speakers can be connected to the XM910: A single speaker can be connected to either the A or B jack of AMP 1 and AMP 2, two speakers can be connected in parallel to both the A and B jacks of AMP1 and AMP 2, or a single speaker can be connected to the BRIDGE jack (bridge connection). For each of these, the required speaker impedance will differ.

Refer to the following diagram, and make sure that the speaker impedance is not less than the specified value.

Additional, or alternative amplifiers can be connected to the MAIN MIX OUT and MONITOR AUX 1 SEND jacks on the front panel.

When connecting one speaker to POWER AMP 1 and one speaker to POWER AMP 2, use speakers with a 4 – 8 ohm impedance rating.

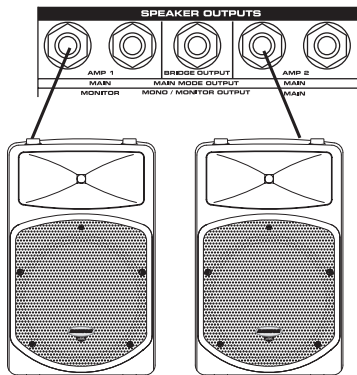

When connecting two speakers to POWER AMP 1 and two speaker to POWER AMP 2, use speakers with a 8 – 16 ohm impedance rating.

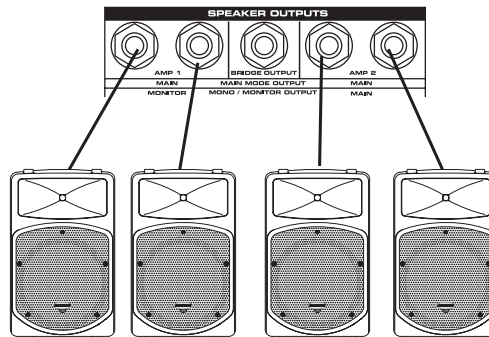

When the POWER AMPS are in BRIDGE use a speakers with a 8 – 16 ohm impedance rating.

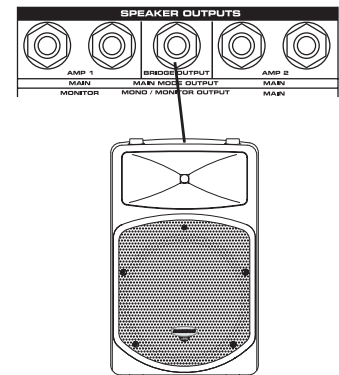

Operating the XM910

BASIC OPERATION

The following section explains the basic operation of the XM910.

CONNECTING MICROPHONES AND INSTRUMENTS

1. Before connecting mics or instruments, make sure that the power of all your systems components, including the XM910, is turned off. Also, make sure that the volume and gain controls of each channel of the XM910 and the MASTER controls of the MAIN and MONITOR section are turned all the way down.
2. Connect the cables to your microphones and instruments, and insert the other end of the cable firmly into the appropriate input on the XM910.
3. Switch on the power of any peripheral devices, and then power up the XM910.

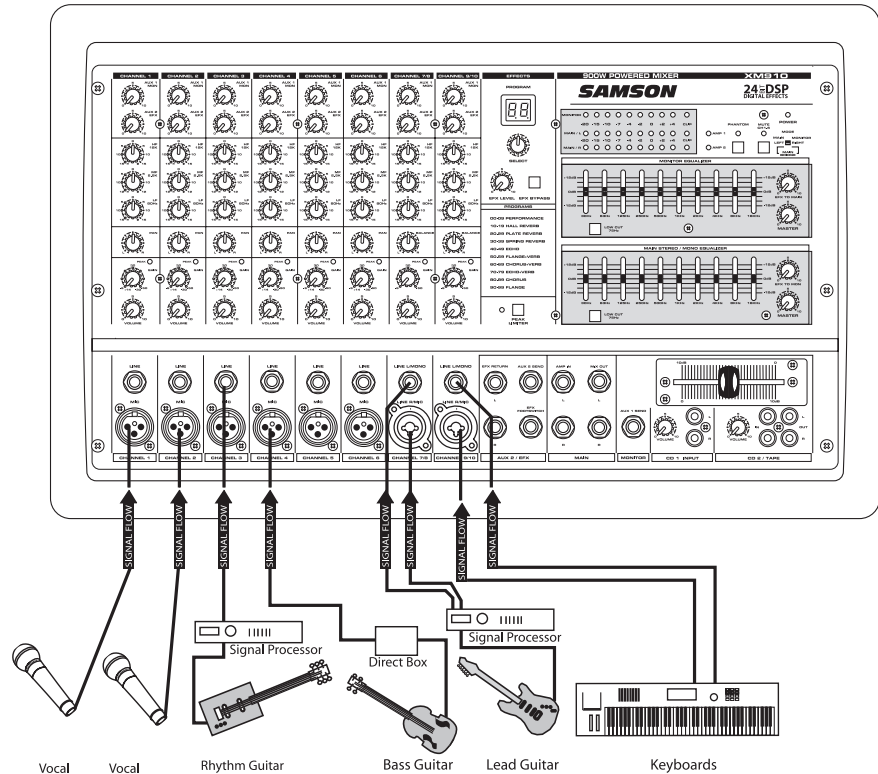

NOTE: Since the XM910 contains two power amplifiers, it is important to remember the Golden Rule of audio ... "LAST ON, FIRST OFF".

Translated, this means that when turning on your system, you should always turn your power amplifiers on LAST, and when turning your system off, turn your power amps off FIRST. This helps avoid any loud pops caused by rush current at power up or power down, which can sometimes damage loudspeakers .

4. Set the MASTER control of the MAIN section to the "5" position.
5. While speaking into the mic (or playing the instrument), adjust the channel GAIN control so that the "PEAK" LED of the channel lights occasionally, then back it down slightly.
6. Slowly adjust the channel VOLUME control until the desired level is reached.
7. If you wish to adjust the tone of each channel, adjust the equalizer controls as desired. You may have to readjust the channel volume.
8. Use the MAIN section graphic equalizer and MASTER control to adjust the overall volume and tone.

Operating the XM910

USING THE DIGITAL EFFECTS

The XM910 features a built-in, high quality, 24 BIT Digital Signal Processor offering studio grade effects. The DSP features clean Delay, lush Reverbs and multi-effects like Chorus + Delay or Chorus + Reverb. You can add a broad range of studio quality effects by simply dialing through the 100 presets. The following details the operation of the internal DSP effects:

1. Connect a mic or instrument to the desired channel, and adjust the volume and equalizer to your liking.
2. Now select the desired preset using the EFFECTS SELECT switch. Set the DSP SELECT switch to one of the following 100 effects:

0 - 9	Performance
10 - 19	Hall Reverb
20 - 29	Plate Reverb
30 - 39	Spring Reverb
40 - 49	Echo
50 - 59	Flange + Verb
60 - 69	Chorus + Verb
70 - 79	Echo + Verb
80 - 89	Chorus
90 - 99	Flange

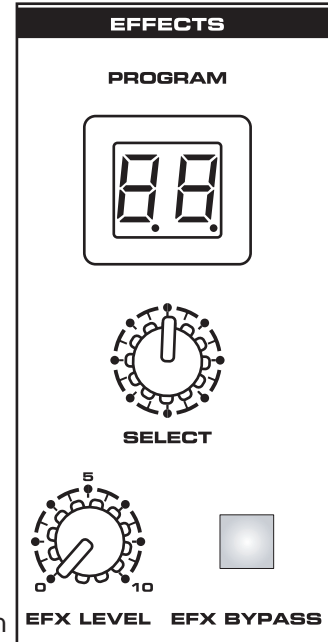

4. Once you have selected the desired effect preset, raise the AUX 2 EFX control on the channels you wish to apply the digital effect to.

5. Now use the EFX to MAIN/MON knob in the MAIN/MONITOR section to adjust the EFFECTS Return level. The EFX to MAIN/MON control is the overall level control for the DSP effects processor. If you are not using the XM910 in MAIN/ MONITOR or BRIDGE mode, be sure to raise the EFX to MAIN/MON control up on both the MAIN and MAIN/ MONITOR sections so the level of effect is the same in both speakers.

NOTE: If the effect sound is distorted even though the EFX to MAIN/MON is turned down low, lower the AUX 2 EFX controls of each channel.

SENDING AN INDEPENDENT MIX TO THE MONITOR SPEAKERS

The XM910 allows you to operate the power amplifiers in a MAIN/ MONITOR mode. This lets you use one amplifier for speakers facing the audience, and the other amplifier for the monitor speaker facing the musicians.

1. Set the channel MONITOR section and VOLUME control to the "0" position.

2. Raise the AUX 1 MON controls for the channels that you wish to hear from the monitor speakers.

NOTE: The MONITOR controls are not affected by the level settings of each channel. This allows you to create a mix for the monitors that is independent of the MAIN mix.

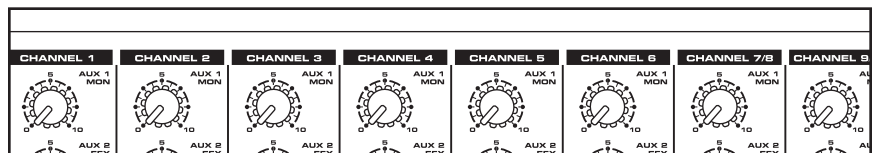

3. Use the graphic equalizer and MASTER controls of the MAIN/MONITOR sections to adjust the overall volume and tone.

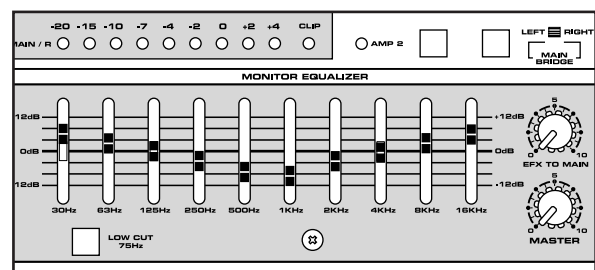

Operating the XM910

USING AN EXTERNAL EFFECT

If you prefer to use an external device for effects processing, you can easily connect the unit using the XM910 EFX bus. Follow the simple steps below to interface your processor:

1. Set the MONITOR section MASTER control to the "0" position. Press the EXFX BYPASS switch to disable the internal DSP.
2. Raise the AUX 2 EFX controls for the channels to which you want the external effect to be applied.
3. Now adjust the EFX LEVEL to about half way.
4. Set the input level of the external effect so that the sound is not distorted and so that the effect's input meter does not indicate a clipped signal.
5. Use the EFX TO MON control to adjust the level of the effects processed by the external effects device.

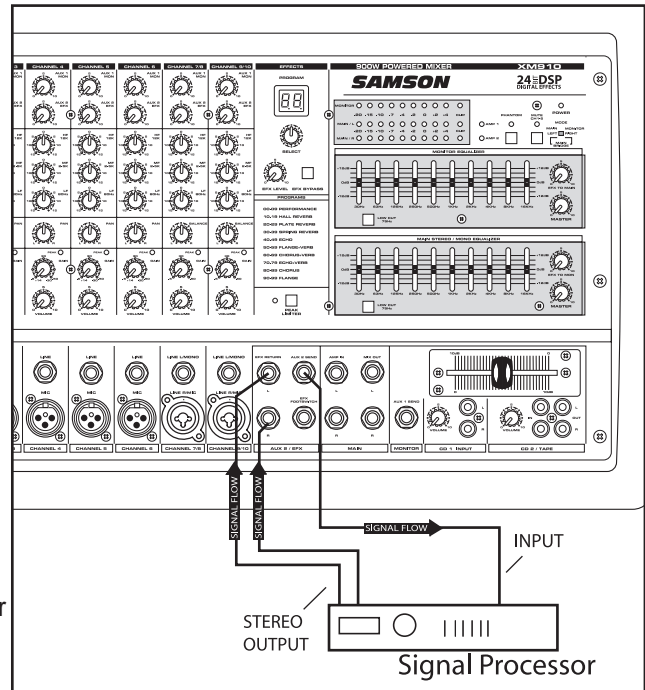

USING THE MAIN OUTPUTS AND AMP INPUTS AS AN EFFECTS LOOP

You can use the XM910's MAIN Left and Right outputs along with the Left and Right AMP inputs as a stereo insert point, or effects loop, for connecting an external signal processor. This will allow you to apply an effect on the entire main stereo mix. You may want to use an external dynamics processor like a compressor. The following section details the hook up.

1. Using standard 1/4-inch shielded cables, connect the MAIN Left and Right outputs to the left and right inputs of a stereo compressor like a Samson C com 16 or S com plus.
2. Using standard 1/4-inch shielded cables, connect the left and right outputs of your compressor to the Left and Right AMP IN connectors.
3. Now, follow the directions in your compressor users manual to set the correct gain structure and to adjust the parameters for compressing your signal.

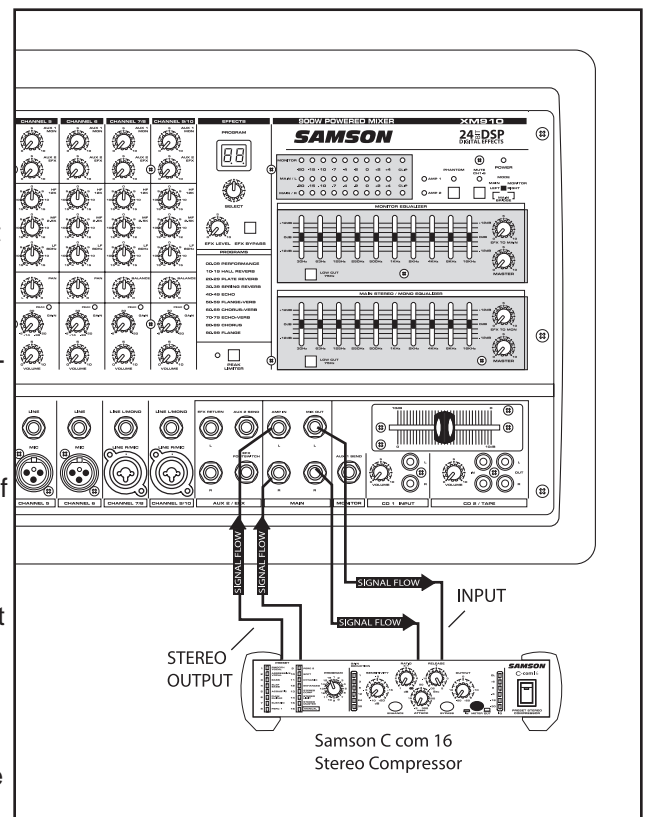

Operating the XM910

USING THE DJ MIXER

The XM910 has an on-board DJ mixer, which you can use for playing back a CD, Tape or Mini Disk. The DJ mixer section features 2 CD / TAPE inputs and a removable crossfader. The crossfader allows you to mix between the CD 1 and CD 2 inputs. When the crossfader is set all the way to the left, CD 1 input is selected. To listen to the CD 2 input, slide the crossfader all the way to the right side. As you move between the CD 1 and CD 2 inputs, the mixer will cross-fade the two input signals. The result is that you are lowering one CD input while simultaneously raising the other CD input.

1. Turn the CD 1 and CD 2 level controls and the MASTER level control all the way down.
2. Slide the crossfader all the way to the left to select CD 1 input.
3. Follow the "LAST ON, FIRST OFF" rule and turn on your peripheral devices and then the power on the XM910.
4. Adjust the MASTER volume control of the MAIN section to the "5" position.
5. Start playback on the CD, Tape or MD player connected to CD 1, and use the CD 1 LEVEL control to adjust the level so that the zero LED of the MAIN section peak level meter lights occasionally.
6. Now, slide the crossfader all the way to the right to select CD2 input.
7. Start playback on the CD, Tape or MD player connected to CD 2, and use the CD 2 LEVEL control to adjust the level so that the zero LED of the MAIN section peak level meter lights occasionally.
8. Adjust the master volume control to raise the level if necessary.

You can engage the CH 1 – 6 mute switch to turn off the channel 1 - 6 inputs, and still have a live microphone on channel 7/8 or 9/10 if you need to be the Master of Ceremony and "get the party started right".

RECORDING YOUR PERFORMANCE FROM THE XM910

You can record the audio from the XM910's mixer section including the MIC, LINE, TAPE IN and AUX inputs to a cassette deck, MD, DAT or any other type of recorder using the record outputs. Simply connect the XM910's CD 2/ TAPE OUT jacks to the input jacks of the recorder as shown in the diagram below.

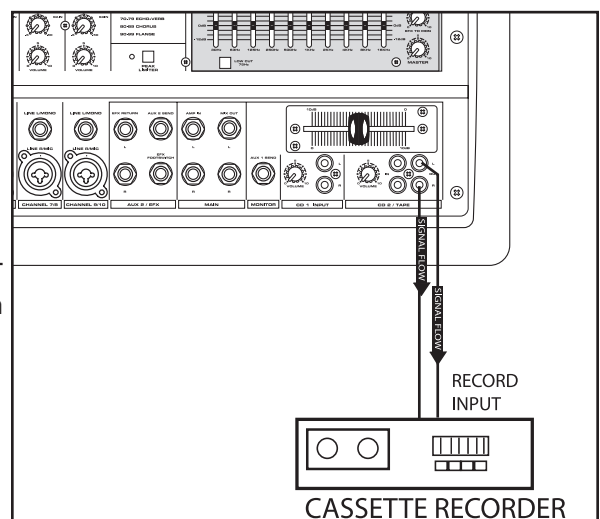
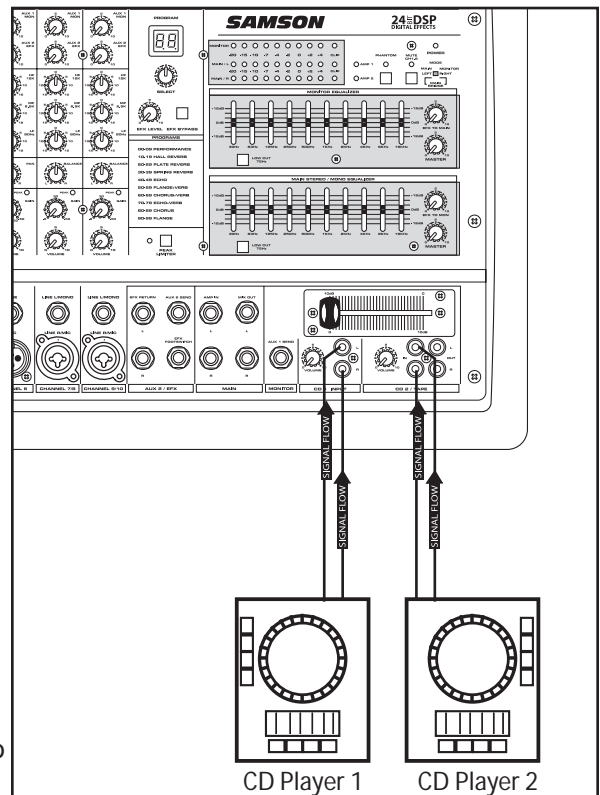

XM910 System Set-Ups

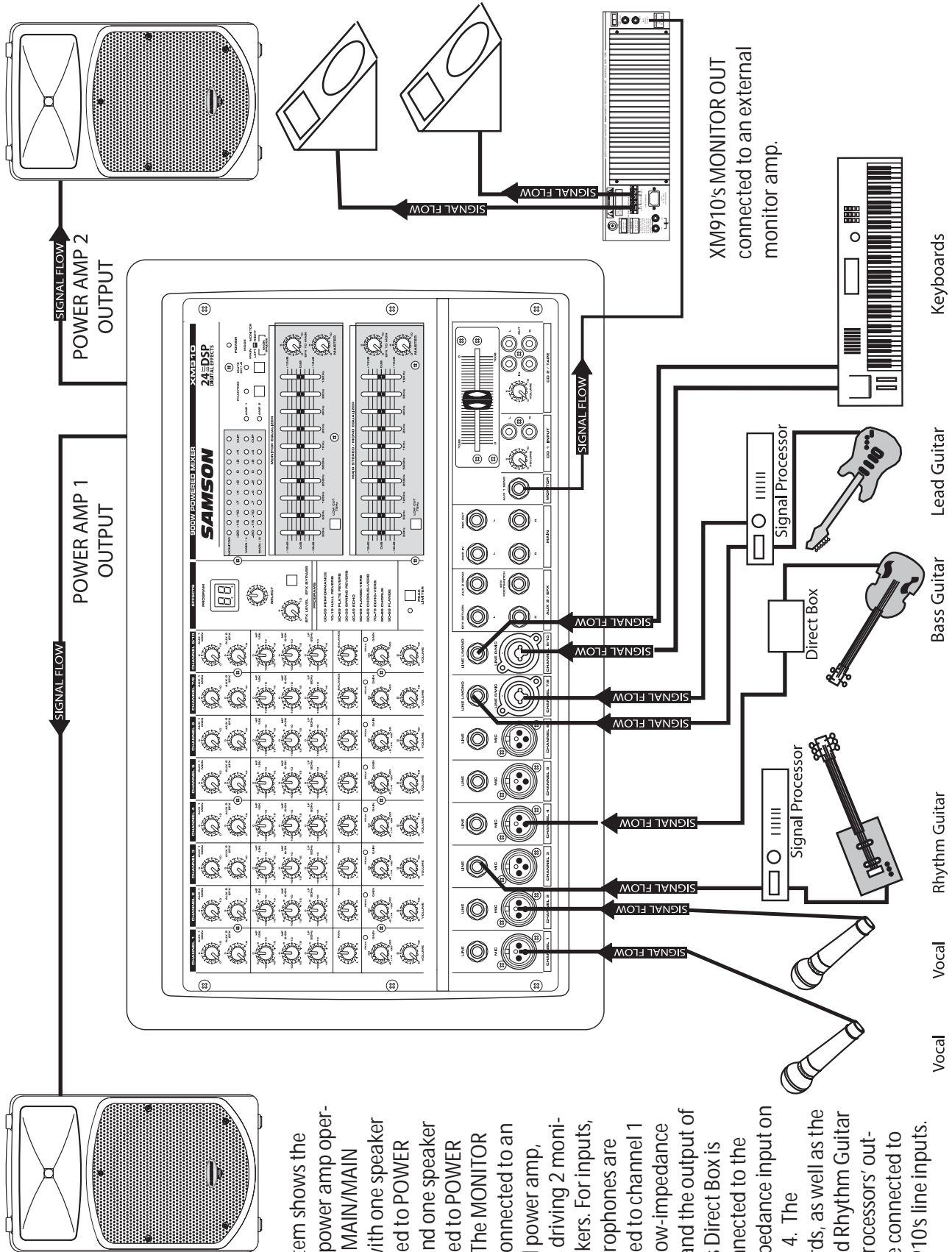

This system shows the XM910 power amp operating in MAIN/MAIN mode, with one speaker connected to POWER AMP 1 and one speaker connected to POWER AMP 2. The MONITOR OUT is connected to an external power amp, which is driving 2 monitor speakers. For inputs, two microphones are connected to channel 1 and 2's low-impedance inputs, and the output of the Bass Direct Box is also connected to the Low-Impedance input on channel 4. The Keyboards, as well as the Lead and Rhythm Guitar signal processors' outputs, are connected to the XM910's line inputs.

XM910 System Set-Ups

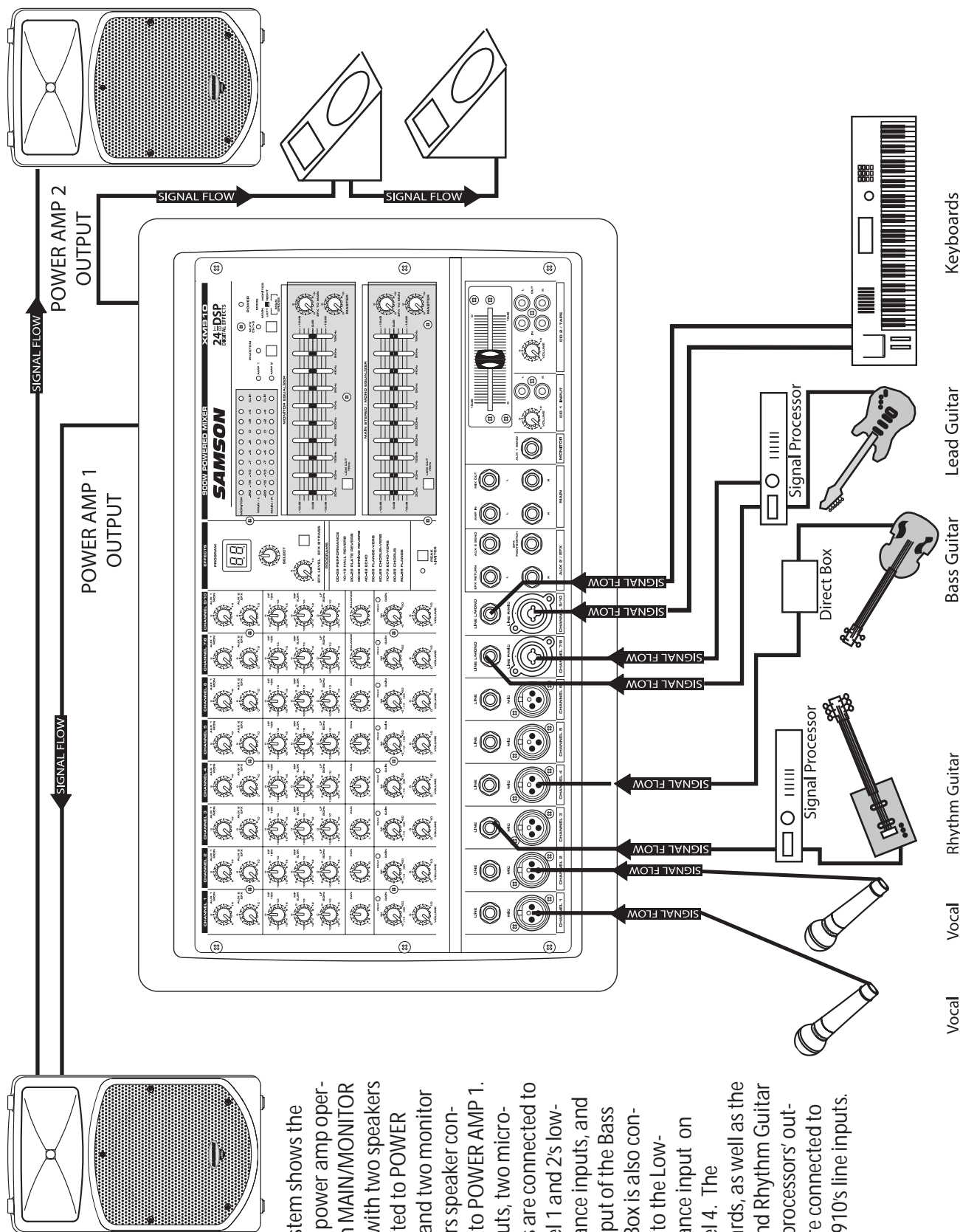

This system shows the XM910 power amp operating in MAIN/MONITOR mode, with two speakers connected to POWER AMP 2 and two monitor speakers speaker connected to POWER AMP 1. For inputs, two microphones are connected to channel 1 and 2's low-impedance inputs, and the output of the Bass Direct Box is also connected to the Low-Impedance input on channel 4. The Keyboards, as well as the Lead and Rhythm Guitar signal processors' outputs, are connected to the XM910's line inputs.

XM910 Wiring Guide

CONNECTING THE XM910

There are several ways to interface the XM910 to support a variety of applications. The XM910 features balanced inputs and outputs, so connecting balanced and unbalanced signals is possible.

Unbalanced 1/4" Connector

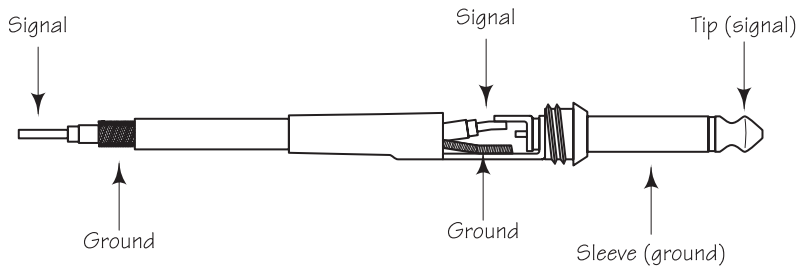

Balanced TRS 1/4" Connector

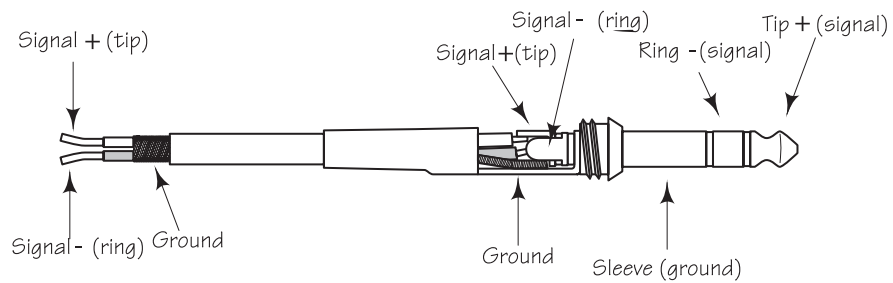

XLR Balanced Wiring Guide

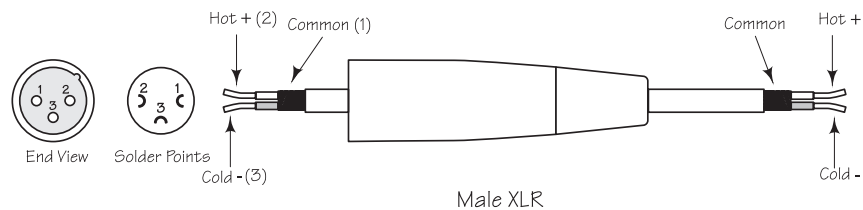
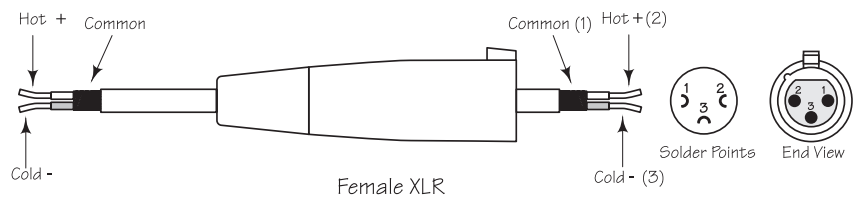

Specifications

SPECIFICATIONS

Rated Output power	2 X 450W at 4Ω @0.1% THD at 1KHz
Frequency response	20Hz~20KHz+/-0.7dB@1W Output into 8Ω (AMP OUT) 20 Hz~20KHz+/-0.4@+4dB Output into 10kΩ (MAIN OUT, MONITOR OUT, AUX 2 SEND)
Total Harmonic Distortion	Less than 0.06%@20Hz~20KHz, 75W output into4Ω (AMP OUT) Less than 0.1%@20 Hz~20KHz+14dB output into 10KΩ (MAIN OUT, MON OUT, AUX 2 SEND)HUM & Noise -121dB
equivalent input noise (Average, RS+150Ω)	-100dB residual output noise (MAIN OUT, MONITOR OUT, AUX 2 OUT)
(with 22Hz~22KHz BPF)	-79dB (MAIN OUT, MONITOR OUT) Master level control at maximum, all channel level control at minimum. -79dB (AUX 2) Master level control at maximum, all channel level controls at minimum
Maximum Voltage Gain	67dB CH IN (MIC) to AMP OUT 63dB CH IN (MIC) to MAIN OUT, MONITOR OUT 54dB CH IN (MIC) to AUX 2 OUT 30dB CH IN (MIC) to REC OUT 32dB CH IN (LINE) to MAIN OUT, MONITOR OUT 26dB AUX IN to MAIN OUT 24dB TAPE IN to MAIN OUT
Crosstalk 1KHz	70dB adjacent input, 70dB input to output
Input Channel Equalization	HIGH 12KHz shelving (+/- 15dB Maximum) MID 2.5KHz peaking (+/- 12dB Maximum) LOW 80Hz shelving (+/- 15dB Maximum)
Meters	9 POINT LED METERS (-20, -15, -10, -7, -4,-2, 0, +2, +4dB)
Graphic Equalizer	10 bands (30, 63, 125, 250, 500, 1K, 2K, 4K, 8K, 16KHz)
Internal DSP Effects	24 BIT - 10 Presets each: 1 - Performance; 2 - Hall Reverb, 3 - Plate Reverb; 4 - Spring Reverb; 5 - Echo; 6 - Flange + Verb; 7 - Chorus + Verb; 8 - Echo + Verb; 9- Chorus; 10- Flange
Phantom Power	+48V
CLIP Indicators	Turn on: THD> 0.1%
Foot Switch	DIGITAL EFFECT MUTE: ON/OFF
GENERAL	
Power Requirement	110V-240V, 50/60Hz
Power Consumption	950W, MAX.
Weight	40 lbs./18.2Kg
Dimensions	21" (W) x 14" (H) x 13-3/4" (D) 534mm(W) x 356mm(H) x 350mm(D)

Block Diagram

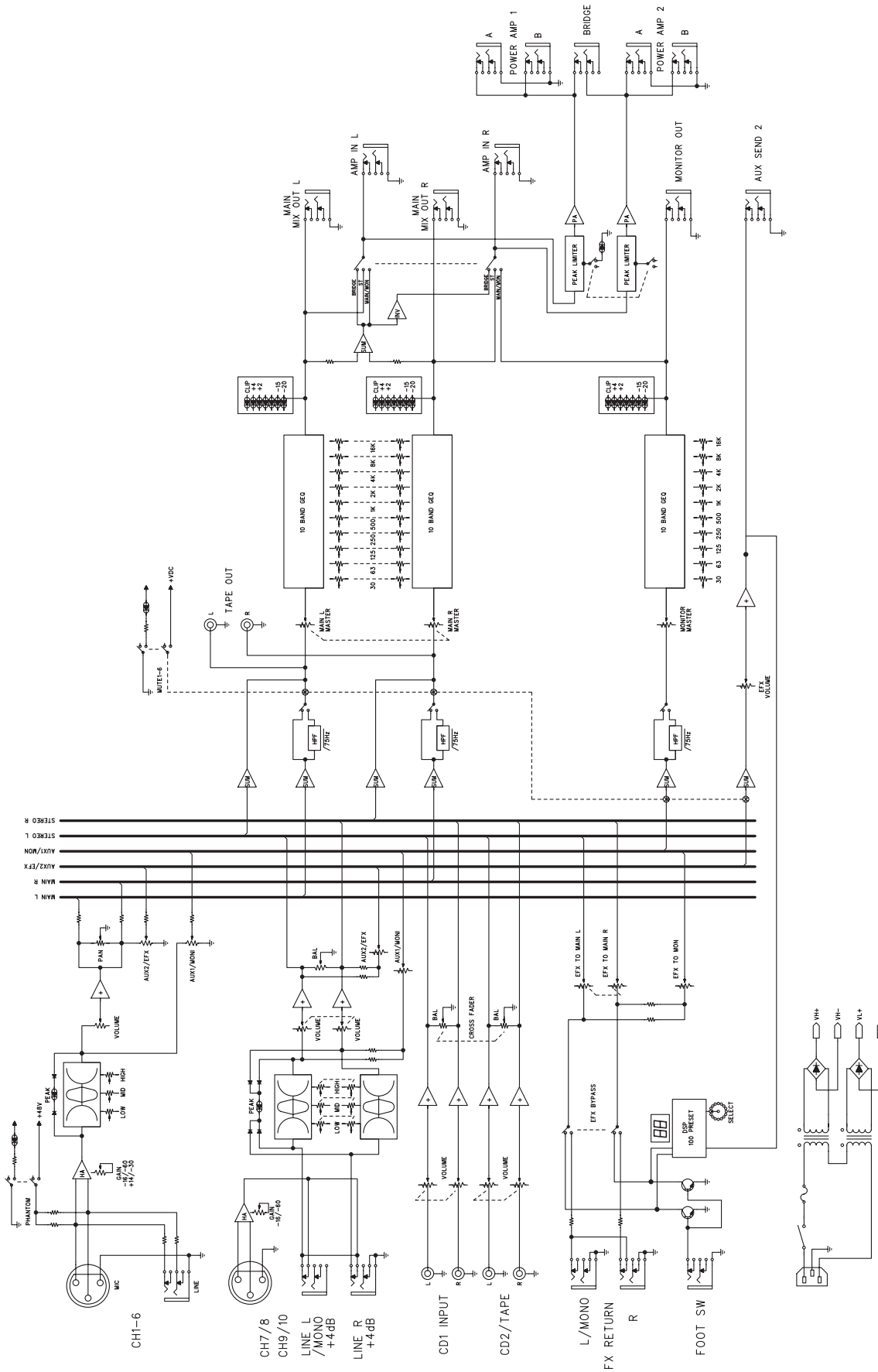

Samson Technologies Corp.
575 Underhill Blvd.
P.O. Box 9031
Syosset, NY 11791-9031
Phone: 1-800-3-SAMSON (1-800-372-6766)
Fax: 516-364-3888
www.samsontech.com

Free Manuals Download Website

<http://myh66.com>

<http://usermanuals.us>

<http://www.somanuals.com>

<http://www.4manuals.cc>

<http://www.manual-lib.com>

<http://www.404manual.com>

<http://www.luxmanual.com>

<http://aubethermostatmanual.com>

Golf course search by state

<http://golfingnear.com>

Email search by domain

<http://emailbydomain.com>

Auto manuals search

<http://auto.somanuals.com>

TV manuals search

<http://tv.somanuals.com>