

S·curve 231

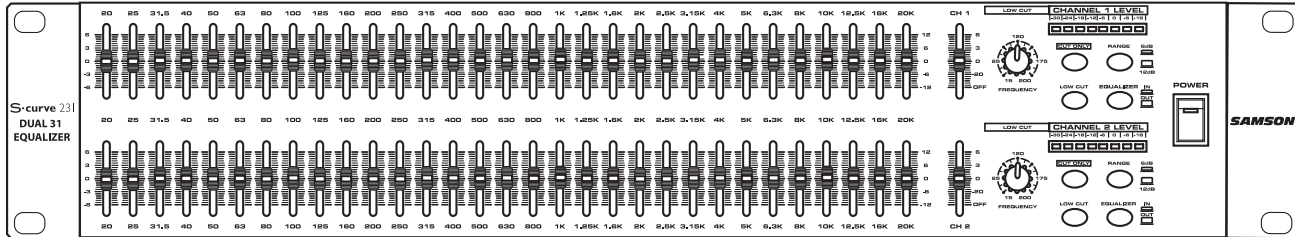

DUAL 31 BAND EQUALIZER

Owners Manual

SAMSON
A U D I O

Safety Instructions

Caution: To reduce the hazard of electrical shock, do not remove cover or back.

No user serviceable parts inside. Please refer all servicing to qualified personnel.



WARNING: To reduce the risk of fire or electric shock, do not expose this unit to rain or moisture.

The lightning flash with an arrowhead symbol within an equilateral triangle, is intended to alert the user to the presence of uninsulated "dangerous voltage" within the products enclosure that may be of sufficient magnitude to constitute a risk of electric shock to persons.

The exclamation point within an equilateral triangle is intended to alert the user to the presence of important operating and maintenance (servicing) instructions in the literature accompanying the product.

Important Safety Instructions

1. Please read all instructions before operating the unit.
2. Keep these instructions for future reference.
3. Please heed all safety warnings.
4. Follow manufacturers instructions.
5. Do not use this unit near water or moisture.
6. Clean only with a damp cloth.
7. Do not block any of the ventilation openings. Install in accordance with the manufacturers instructions.
8. Do not install near any heat sources such as radiators, heat registers, stoves, or other apparatus (including amplifiers) that produce heat.
9. Do not defeat the safety purpose of the polarized or grounding-type plug. A polarized plug has two blades with one wider than the other. A grounding type plug has two blades and a third grounding prong. The wide blade or third prong is provided for your safety. When the provided plug does not fit your outlet, consult an electrician for replacement of the obsolete outlet.
10. Protect the power cord from being walked on and pinched particularly at plugs, convenience receptacles and at the point at which they exit from the unit.
11. Unplug this unit during lightning storms or when unused for long periods of time.
12. Refer all servicing to qualified personnel. Servicing is required when the unit has been damaged in any way, such as power supply cord or plug damage, or if liquid has been spilled or objects have fallen into the unit, the unit has been exposed to rain or moisture, does not operate normally, or has been dropped.

Table of Contents

Introduction	2
System Features	3
Controls and Functions	
Front Panel	4
Rear Panel	5
Setting Up and Using the S curve 231	6 - 7
System Configurations	8 - 10
About Equalization	11
Grounding Techniques	12
Using a Patchbay	12
Using the S curve 231 with an RTA	13
Using the S curve 231 to Remove Feedback	14
S curve 231 Wiring Guide	15
Specifications	16
Pass-Band Graphs	16
Block Diagram	17

Copyright 2003, Samson Technologies Corp.

Printed Oct., 2003

Samson Technologies Corp.
575 Underhill Blvd.
P.O. Box 9031
Syosset, NY 11791-9031
Phone: 1-800-3-SAMSON (1-800-372-6766)
Fax: 516-364-3888
www.samsontech.com

Introduction

Congratulations on purchasing the Samson S curve 231 dual channel, 1/3 Octave, 31 Band Constant Q Graphic Equalizer! Although this product is designed for easy operation, we suggest you take some time out first to go through these pages so you can fully understand how we've implemented a number of unique features.

The S curve 231 is a professional quality signal processor that gives you precise tonal control over a stereo, or two mono audio signals. Center detented sliders with LED illumination allow you to selectively cut or boost selected frequency areas by as much as 24 dB. Front panel controls include output level sliders, a variable Lowcut filter, as well as Cut Only, Range and Bypass switches. The rear panel provides electronically balanced inputs and outputs on 1/4-inch and XLR connectors. Thanks to low noise circuitry, the S curve 231 can be used in a wide variety of applications, including live performance (in conjunction with either Front Of House or monitor mixers), in broadcast environments, or for recording.

In this manual, you'll find a more detailed description of the features of the S curve 231, as well as a guided tour through the front and rear panels, step-by-step instructions for using the unit, suggested applications for use with a patch bay, a Real Time Analyzer (RTA) or for ringing out monitor systems.

You'll also find a warranty card enclosed—please don't forget to fill it out and mail it so that you can receive online technical support and so we can send you updated information about other Samson products in the future. Also, be sure to check out our website (<http://www.samsontech.com>) for complete information about our full product line.

With proper care and adequate air circulation, your S curve 231 will operate trouble free for many years. We recommend you record your serial number in the space provided below for future reference.

Serial number: _____

Date of purchase: _____

Should your unit ever require servicing, a Return Authorization number (RA) must be obtained before shipping your unit to Samson. Without this number, the unit will not be accepted. Please call Samson at 1-800-3SAMSON (1-800-372-6766) for a Return Authorization number prior to shipping your unit. Please retain the original packing materials and if possible, return the unit in the original carton and packing materials.

S curve 231 Features

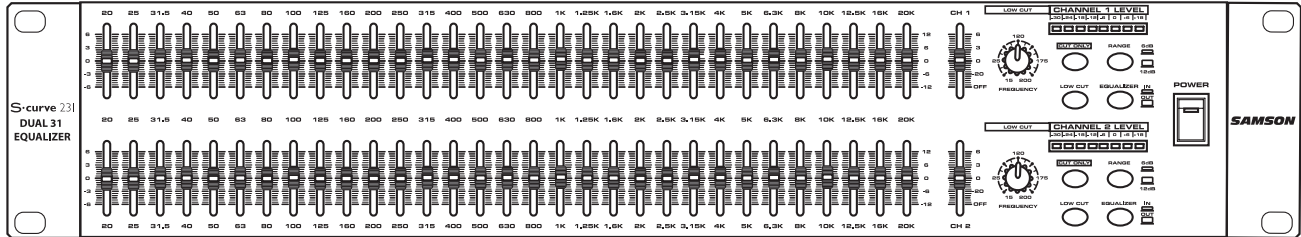

The Samson S curve 231 Graphic Equalizer utilizes state-of-the-art, Constant Q filtering technology for precise tonal control. Here are some of it's main features:

- The S curve 231 is a two channel equalizer and each channel provides 31 bands of equalization, with each frequency band representing 1/3 of an octave in the 20 Hz to 20 kHz range.
- Constant Q circuitry ensures that the bandwidth of the selected frequency area stays the same even when approaching maximum boost or attenuation. As a result, phase shifting and inter-modulation distortion is greatly reduced, making for pristine sound.
- The S curve 231 can be set for either 6 or 12 dB of gain and attenuation for each of the frequency bands.
- For monitor applications, the S curve 231 can be set for CUT ONLY mode providing up to 12dB of attenuation with full slider range.
- Ultra-low noise circuitry ensures superb audio fidelity.
- Variable Low Cut Filter for removing rumble and floor noise can be adjusted from 15 to 200 Hz.
- Electronically balanced XLR and TRS inputs and outputs.
- Front panel, hard-wired, relay controlled Bypass switches (with dedicated Bypass LEDs) allow the equalization circuitry and output level control to be activated or deactivated.
- Main Level control enables output signal to be attenuated or boosted for optimum signal-to-noise ratio.
- LED faders and 8 segment LED bar VU meters.
- Relay power-on circuitry prevents speaker "thumps" when the unit is turned on.
- Internal power supply ensures reliability and trouble-free operation.
- Standard 19", 2 rack-space design for easy integration into any traveling or fixed installation audio system.
- Optional security cover kit prevents EQ settings from accidentally being altered.
- All-steel chassis makes the S curve 231 eminently road-worthy.
- Three year extended warranty.

Controls and Functions

FRONT PANEL LAYOUT

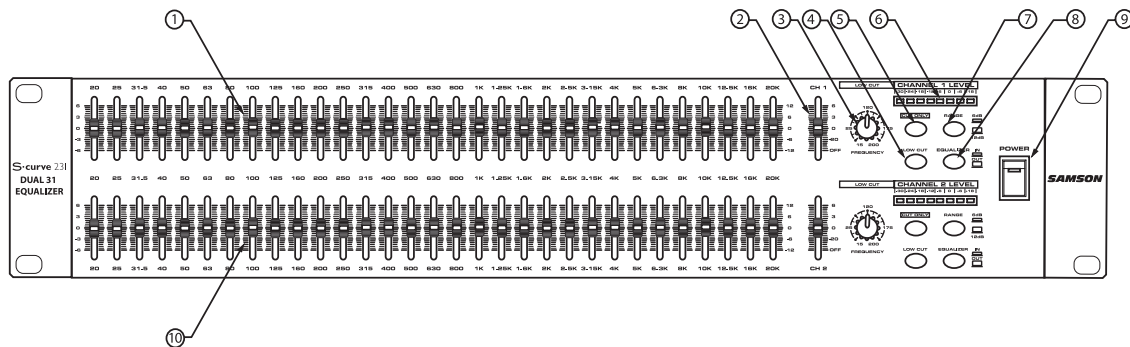

- Equalizer level sliders** - Independent Equalizer sliders are provided for each frequency area (The S curve 231 provides 31 frequency areas). Calibration markings on either side of each Equalizer slider allow you to cut or boost each frequency area. As described below, the exact action of the Equalizer sliders depends upon the setting of the Range switch as well as the setting of the Cut Only switch (see #3 and #5).

When the Cut Only switch is not pressed in: When an equalizer slider is at its center detented 0 position, the frequency area is unaffected (that is, there is no boost or cut). When moved all the way up (to the +12 dB position), the frequency area is boosted by 12 dB (if the corresponding Range switch is not pressed in) or 6 dB (if the corresponding Range switch is pressed in). When moved all the way down (to the -12 dB position), the frequency area is attenuated by 12 dB (if the corresponding Range switch is not pressed in) or 6 dB (if the corresponding Range switch is pressed in).

When the Cut Only switch is pressed in: When an equalizer slider is at its top-most position, the frequency area is unaffected (that is, there is no boost or cut). As the Equalizer slider is moved down, the frequency area is attenuated. When moved all the way down, the frequency area is attenuated by 6 dB (if the corresponding Range switch is pressed in) or 12 dB (if the corresponding Range switch is not pressed in).

- Main Output level slider** - Use this to adjust the output level of signal leaving the S curve 231 via its rear-panel output connectors (see D on page 5 for more information). When the main slider is at its center detented 0 position, the corresponding output signal is at unity gain (that is, there is no level cut or boost). When the main slider is moved all the way up (to the +6 dB position), the output signal is boosted by 6 dB. When a Level slider is moved all the way down (to the ∞ position), the output signal is infinitely attenuated (that is, there is no signal). Note that the Main level slider is deactivated when the S curve 231 is in Bypass mode (see #7).
- Frequency control** - When the Low Cut switch is pressed in, the variable low cut control is active. You can adjust the point at which the low frequencies begin to roll off with a frequency range of from 15 to 200 Hz.
- Low Cut switch** - When pressed in, the LED in the switch lights yellow and the variable highpass filter is applied to the signal. Using the Low Cut can be highly effective in removing rumble and other low frequencies.

Controls and Functions

- ⑤ **CUT ONLY switch** - When pressed in, the LED switch lights and all the Equalizer sliders serve to attenuate their frequency areas only (there is no boost) by up to 6 or 12 dB, depending upon the setting of the RANGE switch (see #7 below). The Cut Only switch should be used when you need to notch out certain frequencies in order to reduce feedback or “ring out” a room. See the “Using the S curve 231 to remove feedback” section in this manual (page 14) for more information.
- ⑥ **LEVEL METER** - This eight segment LED bar VU meter displays the Input Level from -30dB to +18dB.
- ⑦ **Range switch** - When pressed in, the LED in the switch lights and the Equalizer sliders cut or boost each frequency area by up to 6 dB, allowing fine frequency curves to be set. When out (in the up position), the Equalizer sliders cut or boost each frequency area by up to 12 dB, allowing coarse control. The setting of the switch also affects how Cut Only operates—see #1 on the previous page for more information.
- ⑧ **Equalizer switch** - When not pressed in, the equalization circuitry is made inactive so that the signal passes through unaffected, regardless of the settings of the Equalizer or Level sliders. When pressed in, the LED in the switch and the sliders light green and the equalization circuitry affects the signal as per the setting of the front panel Equalizer and Level sliders (see #1 and #2).
- ⑨ **Power switch** - Use this to turn the power on and off.
- ⑩ **Channel 2** - Same functions and controls and Channel 1.

REAR PANEL LAYOUT

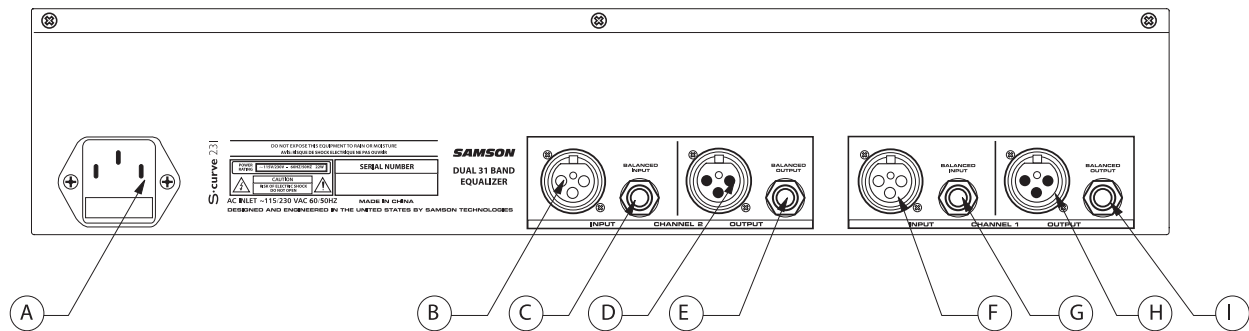

- ① **AC input fuseholder** - Connect the supplied heavy gauge 3-pin “IEC” power cable here.
- ② **CH2 Balanced XLR jack input** - Electronically balanced XLR jack input. Wiring is as follows: pin 2 hot, pin 3 cold, and pin 1 ground.
- ③ **CH2 Balanced 1/4" TRS jack input** - Electronically balanced 1/4" TRS jack input. Wiring is as follows: tip hot, ring cold, and sleeve ground.
- ④ **CH2 Balanced XLR jack output** - Electronically balanced XLR jack output. Wiring is as follows: pin 2 hot, pin 3 cold, and pin 1 ground.
- ⑤ **CH2 Balanced 1/4" TRS jack output** - Electronically balanced 1/4" TRS jack output. Wiring is as follows: tip hot, ring cold, and sleeve ground.
- ⑥ **CH1 Balanced XLR jack input** - Electronically balanced XLR jack input. Wiring is as follows: pin 2 hot, pin 3 cold, and pin 1 ground.
- ⑦ **CH1 Balanced 1/4" TRS jack input** - Electronically balanced 1/4" TRS jack input. Wiring is as follows: tip hot, ring cold, and sleeve ground.
- ⑧ **CH1 Balanced XLR jack output** - Electronically balanced XLR jack output. Wiring is as follows: pin 2 hot, pin 3 cold, and pin 1 ground.
- ⑨ **CH1 Balanced 1/4" TRS jack output** - Electronically balanced 1/4" TRS jack output. Wiring is as follows: tip hot, ring cold, and sleeve ground.

SETTING UP THE S curve 231

SETTING UP THE S curve 231

Setting up your S curve 231 Graphic Equalizer is a simple procedure which takes only a few minutes:

1. Remove all packing materials (save them in case of need for future service) and decide where the unit is to be physically placed—it can be used free-standing or mounted in a standard 19" rack.
2. Make sure the power to all mixers and amplifiers in your audio system is off. On the front panel of the S curve 231, place the Bypass switch to it's out (off) position and set the Main Level slider to it's bottom-most "OFF" setting.
3. Set all Equalizer sliders to their flat ("0") center detented position.

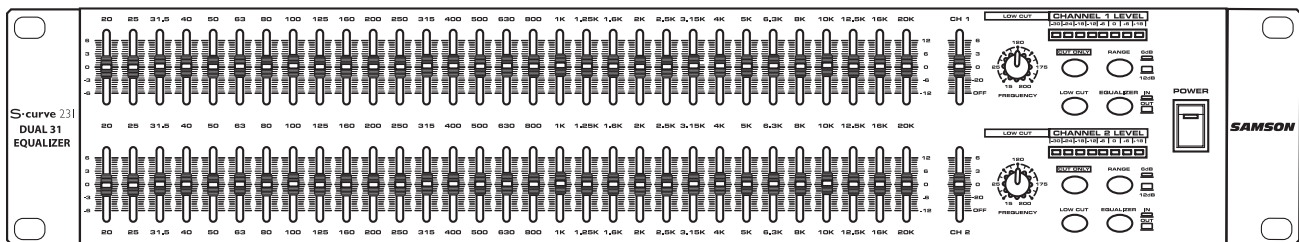

4. The S curve 231 can be used either as an "in-line" device, as an insert device (in conjunction with mixer insert points), or in an effects send-return loop. The illustrations on pages 8-10 show each of these typical configurations. Choose the configuration that is best for your application and then begin by making the S curve 231 input connections, using either the XLR or 1/4" TRS connectors on the rear panel. **WARNING: Both the XLR and 1/4" TRS inputs should not be connected simultaneously, or loading problems may result.**
5. Next, make the S curve 231 output connections, using the XLR or 1/4" TRS connectors on the rear panel. If required, connections can be made simultaneously to both.
6. Plug in the supplied AC connector and connect it to any standard AC socket. Because of the special relay power-on circuitry built into the S curve 231, you can even plug it into the same power strip that other audio devices (such as a mixing console) are connected to. You can then turn on all devices at once with the single power strip on-off switch, without generating speaker "thumps".

SETTING UP THE S curve 231

7. Press the front panel Power switch to turn on the S curve 231. Press the Equalizer switches in to activate the equalizer. Note that audio signal will be muted for approximately five seconds until the relay power-on circuitry is activated (at which time you'll hear a click and the audio signal will be unmuted).
8. Apply an input signal to the S curve 231 (if sending signal from a mixer output bus, drive the mixer's output meters at approximately 0 VU). While the input signal is present, slowly raise the front panel main level slider to its center detented "0" point. For best signal-to-noise ratio, the main level slider should be at or near the "0" point during normal operation. However, if the input signal is weak, use the main level slider to slightly boost the volume (to a maximum of 6 dB). Conversely, if the signal causes the front panel +18 LEDs to light, use the main level slider to attenuate volume as necessary. In normal operation, the +18 LED should not light at all; if they do, use the main level slider to lower the volume of the output signal so that it does not light at all (clipping not only sounds awful, it can also damage speakers!).
9. Experiment by moving each of the Equalizer sliders up and down, carefully listening to the audible result on the audio signal. Bear in mind that the very lowest and highest frequency areas may have little or no effect on some signals. If there is significant low frequency noise (rumble) in the signal, engage the Low Cut switch. Starting with the Low Cut frequency control fully counter-clockwise, adjust the control so that the rumble is eliminated but the bass content of the signal still remains. Some experimenting with this control may be necessary to achieve a satisfying result. As you work with the various front panel controls, press the front panel Equalizer switch in and out from time to time in order to compare the effect of the equalization curve you are creating with the original input signal.
10. Once you've created the frequency curve required for your particular application (see the "About Equalization" section on the following pages for more information), an optional locking security cover (available from your local Samson dealer) can be placed over the front panel to make sure that your settings are not inadvertently altered.

If you have followed all the steps above and are experiencing difficulties with any aspect of setting up or using your S curve 231, you can call Samson Technical Support (1-800-372-6766) between 9 AM and 5 PM EST, or contact your local distributor.

S curve 131 System Configurations

Using the S curve 231 with Active Speakers

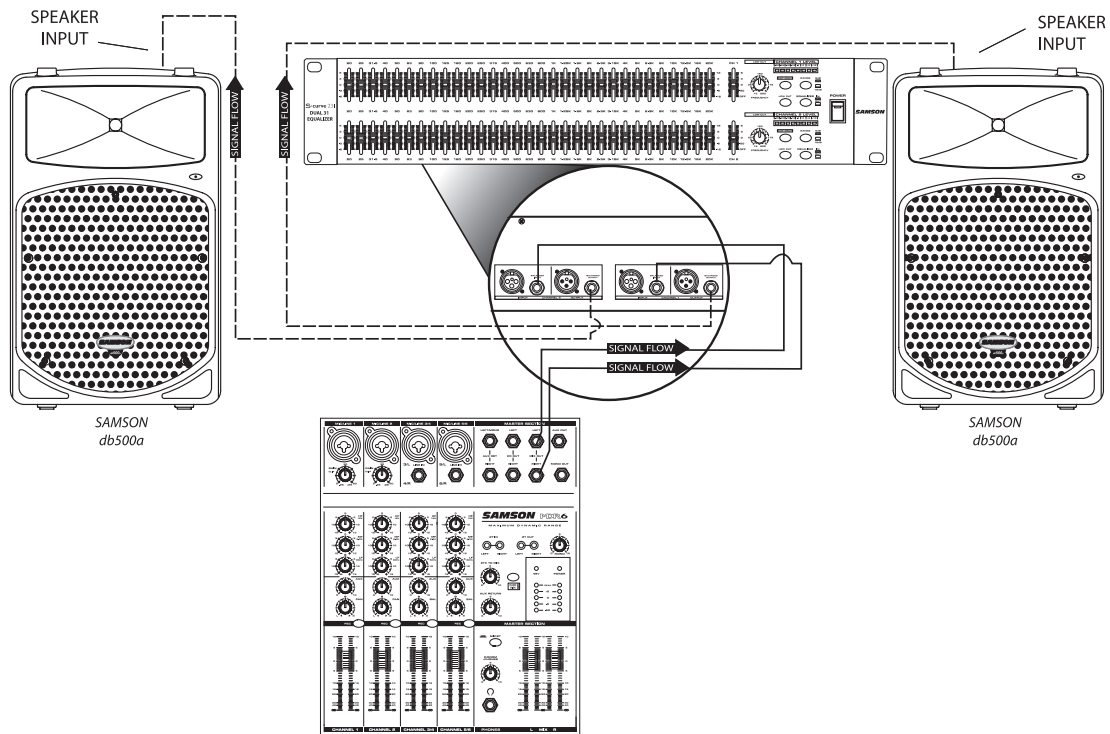

In this example, the mixer's stereo output is connected to the S curve 231's inputs. Then, the S curve 231's outputs are connected to the inputs of each active (self-powered) loudspeaker.

Using the S curve 231 with Passive Speakers

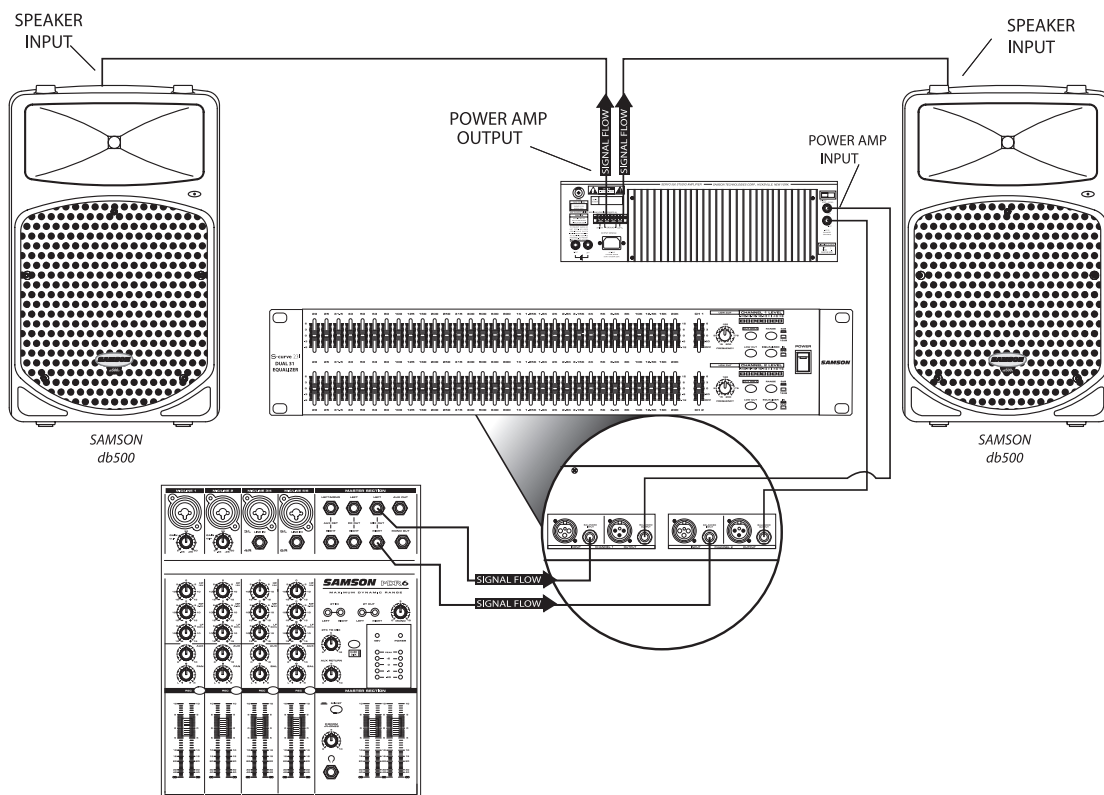

In this example the mixer's stereo output is connected to the S curve 231's inputs. Then, the S curve 231's outputs are connected to the input of a 2-channel power amp. Next, the power amplifier's outputs are connected to the passive (non-powered) loudspeakers.

S curve 131 System Configurations

Using the S curve 231 in Insert Points

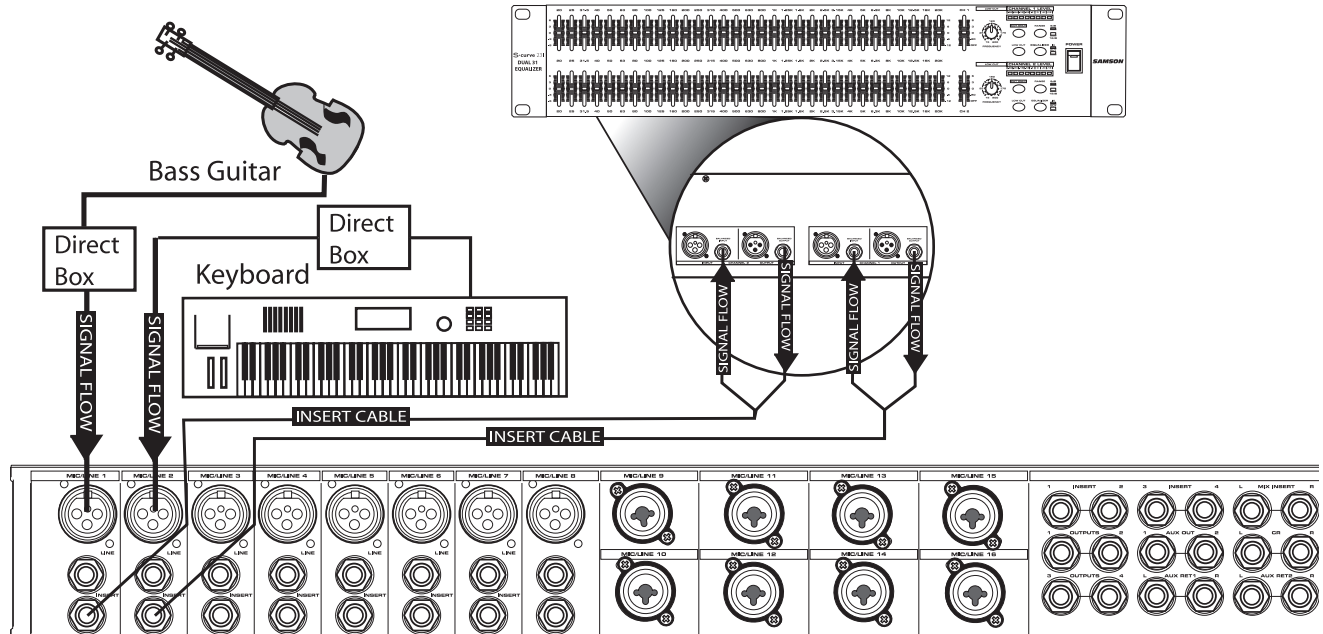

You can use the S curve 231 in your mixer's insert points if you want to equalize two mono channels individually in the mix. In this example the S curve 231's Channel 1 INPUT and OUTPUT are inserted on a bass guitar channel using a 1/4-inch TRS to 2 x 1/4-inch TS "Y" cable, and the Channel 2 INPUT and OUTPUT are inserted on a keyboard channel using the same type of cable. For more information on cable wiring see the S curve 231 Wiring Guide page 15 in this manual.

Using the S curve 231 for Mains and Monitors

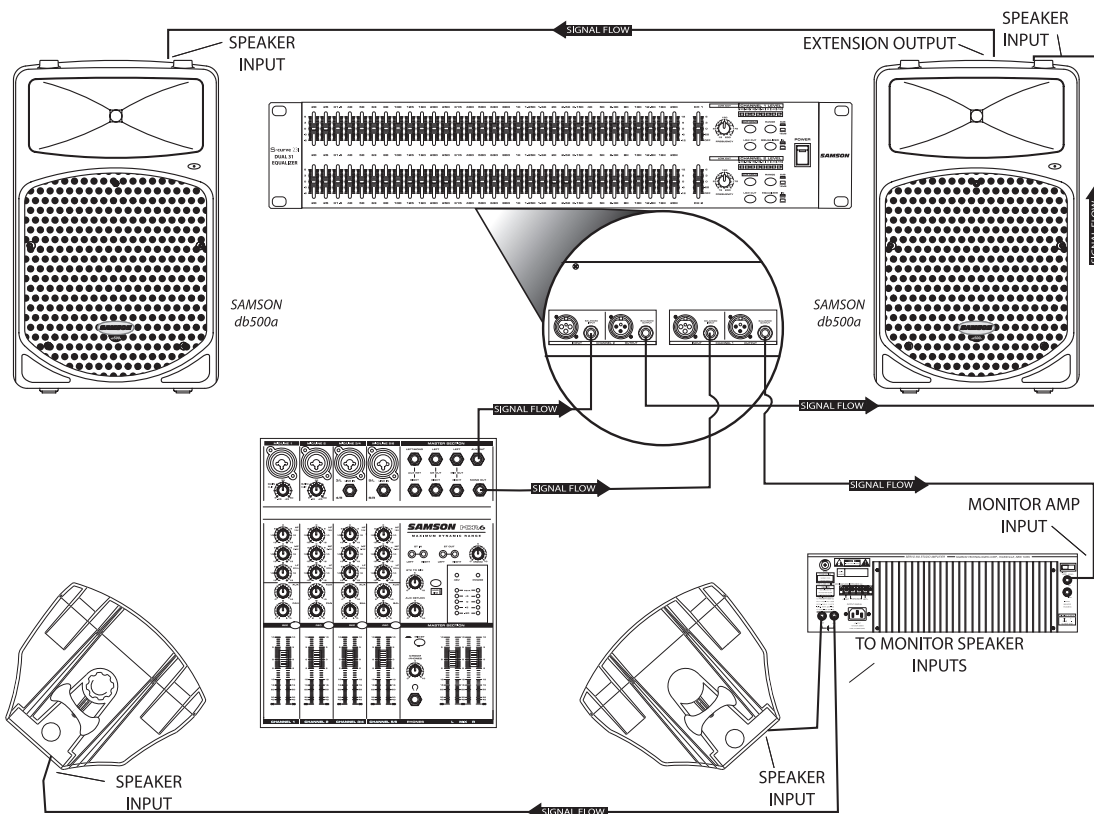

In this example, an S curve 231 is used both for the main PA speakers running a mono mix, and for the monitor mix, also in mono. For the main PA, the mixer's MONO output is connected to the S curve 231's Channel 1 input. Then, the S curve 231's output is connected to the input of the right main PA active (self-powered) loudspeaker. The left main PA speaker is connected by "daisy-chaining" from the right. For the monitor mix, the mixer's AUX output is connected to the S curve 231's Channel 2 input. The S curve 231's Channel 2 output is connected to the input of the monitor power amplifier operating in bridge mode. Finally, the power amplifier's outputs are connected to the passive (non-powered) monitor loudspeakers. (See the owners manual for your specific power amplifier for the proper bridge mode operation.)

S curve 131 System Configurations

Using Two S curve 231's for Mains and Monitors

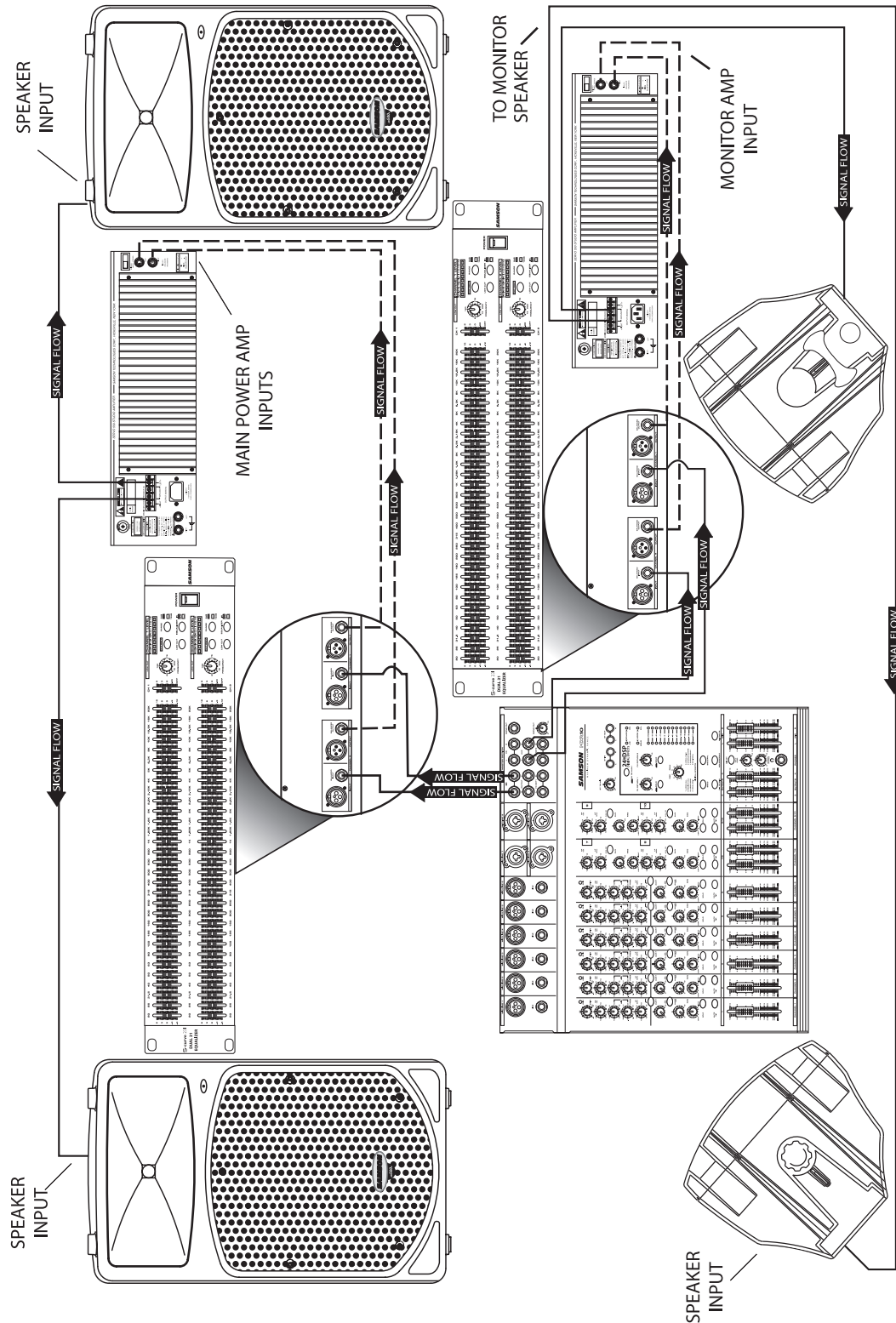

In this example, two S curve 231's are used for the stereo main and for the 2-channel monitor mix. The mixer's left and right outputs are connected to the first S curve 231's inputs for the main PA speakers. Then, the outputs are connected to the inputs of the power amplifier connected to passive loudspeakers. For the monitor mix, the mixer's AUX1 output is connected to the second S curve 231's channel 1 input and AUX2 output is connected to the channel 2 input. Then, the second S curve 231's channel outputs are connected to the inputs of the 2-channel power amp. Finally, the power amplifier outputs are connected to the passive (non-powered) monitor loudspeakers.

About Equalization

The S curve 231 gives you fine control over shaping a sound, using a process called *equalization*. But there are few areas of sound engineering more misunderstood than equalization, and, just as good EQ can really help a sound, bad EQ can really hurt it, so read on...

Every naturally occurring sound consists of a broad range of pitches, or *frequencies*, combined together in a unique way. This blend is what gives every sound its distinctive tonal color. The range of frequencies that can be heard by humans is sometimes called the *audible range*, and it includes frequencies from as low as 20 Hz (that is, 20 wavecycles per second) to those as high as 20 kHz (that is, 20,000 wavecycles per second).

The S curve 231 uses high-quality filters, dividing the audible range into 31, 1/3 octave frequency areas, centered at 20 Hz, 25 Hz, 31.5 Hz, 40 Hz, 50 Hz, 63 Hz, 80 Hz, 100 Hz, 125 Hz, 160 Hz, 200 Hz, 250 Hz, 315 Hz, 400 Hz, 500 Hz, 630 Hz, 800 Hz, 1 kHz, 1.25 kHz, 1.6 kHz, 2 kHz, 2.5 kHz, 3.15 kHz, 4 kHz, 5 kHz, 6.3 kHz, 8 kHz, 10 kHz, 12.5 kHz, 16 kHz, and 20 kHz. "Constant Q" circuitry ensures that the bandwidth of each of these frequency areas stays the same even when approaching maximum boost or attenuation, resulting in greatly reduced phase shifting and intermodulation distortion.

Each frequency area can be cut or boosted by as much as 12 dB, giving you finer control and allowing you to construct gentler frequency curves.

In most instances, the best way to approach equalization is to think in terms of which frequency areas you need to attenuate, as opposed to which ones you need to boost (boosting a frequency area also has the effect of boosting the overall signal; too much EQ boost can actually cause overload). Be aware of the phenomenon of *masking*, where loud sounds in one frequency range obscure softer sounds in the same range; by cutting EQ "notches" in a loud signal, you can actually make room for a softer one to shine through. And try not to think of EQ as a miracle worker—no amount of equalization can put a singer in tune or remove the distortion from an overloaded input signal! The key is to get the signal right in the first place, by using correct gain structure and mic placement.

If you are using your S curve 231 to equalize a complex mono signal (for example, the master mix output of a mixing console), a more natural sound can be obtained by setting up gentle "smile" curves than by simply cutting or boosting individual frequency areas. For example, if you decide that you want to boost one particular frequency area by 6 dB, try boosting the adjacent areas (the frequency directly above and below the target frequency) by 3 dB each.

If you are using your S curve 231 to equalize signal from individual instruments, here are a few general suggestions: Boosting the low frequency areas of instruments such as bass drums or bass guitar will add warmth and make the sound "fatter"; conversely, you may want to attenuate the low frequency components of instruments such as cymbals, high-hats, and shakers so as to "thin" them out. Attenuating mid-range frequencies (the 1 kHz - 5 kHz area) can give a vocal performance more of an "FM-radio" feel, while boosting those frequencies can help a vocal cut through dense instrumentation. Be careful not to boost high frequencies too much or you risk adding hiss to the signal, though just a touch can help add "shimmer" to an acoustic guitar, ride cymbal, or high-hat. You can also use the highest or lowest equalizer sliders to reduce hiss (by attenuating high frequencies) or rumble (by attenuating low frequencies). Rumble can also be attenuated by engaging the front panel Low Cut switch, which inserts a High Pass Filter that is variable from 15 to 200 Hz.

Grounding Techniques

Hum and buzz are the biggest enemies you face when interconnecting a large number of different pieces of equipment to one another. This is because each piece of equipment may operate at a marginally different voltage (this difference is called *potential*) and, when two devices at slightly different potential are physically connected with audio cabling, the end result can be nasty, extraneous noise (mind you, connecting two devices at *very* different potential can result in a major electrical shock!).

However, there are several steps you can take to avoid grounding problems. First, assuming you have an isolated electrical circuit that can handle the electrical demands of all connected audio equipment (these needs will usually be modest), you should always plug all connected equipment into the same circuit. If possible, nothing else but this equipment should be connected to that circuit. If you can't do this, at least avoid plugging your audio equipment into the same circuit that is already powering things like heavy machinery, air conditioners, heaters, refrigerators, washing machines, neon signs or fluorescent light fixtures. One particular culprit that will almost certainly create problems is the standard light dimmer (the kind that uses silicon controlled rectifiers). Where low-level lighting is desired, use incandescent fixtures with autotransformer-type dimmers (sometimes called *Variacs*) instead—these cost considerably more than the standard dimmer you'll find at your local hardware store, but are well worth the extra expense.

Three-prong plugs (such as the one used by the S curve 231) should always be used as is; don't use adapters. If you are using rack-mounted audio devices such as the S curve 231 and are experiencing hum or buzz, there's a simple test to determine the source of the problem: while keeping all devices powered on and connected with audio cabling, physically remove each device, one by one, from the rack. If the hum disappears when a particular device is removed, that device is the culprit.

We also recommend that you use balanced audio cabling and connectors wherever possible. S curve 231 provides electronically balanced inputs and outputs. The diagram on pg. 15 shows how XLR connectors should be wired for use with these inputs and outputs.

In addition, you can minimize possible interference by planning your audio, electrical, and computer cable runs so that they are as far apart from one another as possible and so they don't run parallel to one another. If they have to cross, try to ensure that they do so at a 90° angle (that is, perpendicular to one another). In particular, try to keep audio cabling away from external AC/DC adapters.

If your S curve 231 is in a fixed location such as a recording studio, you may want to invest the time and money into creating a *star ground network*. This is by far the best technique for avoiding grounding problems. It involves using a formidable ground source such as a cold water pipe or a copper spike driven into the earth. A thick grounding cable is connected to that source and is then brought to a central distribution point; from there, individual cables are connected to each piece of equipment. This setup also requires that you lift the ground plug of all three-prong AC connectors, so there is the possibility of danger if it is done incorrectly. We strongly recommend that you contract with a qualified professional to carry out this or any kind of electrical work.

Another, less common problem you may encounter is that of *oscillation* (a ringing tone), which, apart from being annoying, is potentially dangerous to your speakers. This is generally caused either by poor outside wiring or by having an out of phase signal (most commonly from an outboard signal processor). If audible oscillation occurs, you should be able to eliminate the problem by reversing that signal's phase (many signal processors have a switch that allows you to do this).

Using the S curve 231 with a Patchbay

If you are using the S curve 231 with an audio patchbay (such as S patch or S patch plus), you may find it advantageous to connect its inputs and outputs directly to a pair of patch points. This way, you can opt to route signal to the equalizer from any source. For example, in a recording environment where you are using the S curve 231 to "tune" the room, you may typically want to have the control room outputs routed to the equalizer inputs and the equalizer outputs routed to the power amplifier(s) driving the control room speakers. For maximum convenience and flexibility, we recommend that you *half-normal* these connections to the S curve 231 patchpoints, so that the routing will automatically be made unless a patch cable is inserted. If a different signal (such as a bus output or insert) needs to be substituted, you can then override the half-normalled connection simply by inserting a patch cable.

Using the S curve 231 with an RTA

An RTA (Real Time Analyzer) is a device which measures the relative levels of multiple frequency areas. This device, in conjunction with a pink noise generator, is the perfect companion for your S curve 231. Together with a high quality microphone, these tools allow you to fine tune the overall frequency response of your audio system in any given environment (this procedure is sometimes known as “tuning” a room).

To use this kind of system, connect the S curve 231 to your mixer’s main outputs or across main mix output inserts (see pages 8 - 9 in this manual for typical configuration diagrams). Set the S curve 231 Level slider(s) to the center detented “0 dB” position. Because you’ll probably need to boost as well as cut certain frequencies—and because you’ll rarely need to make adjustments of more than 6 dB, make sure both Cut Only switches are in the out position and the range switch is set to the in (6dB) position.

Start by placing all front panel Equalizer sliders at their flat (“0”) center detented position. Then inject pink noise into your loudspeakers via your mixer at a normal operating level (make sure the pink noise is loud enough to drown out any ambient noise floor caused by air conditioners or outside traffic, etc.). Finally, connect a quality microphone to the RTA and place the mic in a typical listening position. Because pink noise consists of all audible frequencies blended together at equal level, the RTA should, in theory, show all frequency bands to be flat. However, due to anomalies in every physical environment, this will rarely if ever be the case. While watching the RTA, use the front panel Equalizer sliders to make corrections to the signal, boosting any dips in the measured frequency response and attenuating any peaks. Repeat the procedure three or four times from different listening positions, averaging the results if necessary to come up with an equalization curve that works well at all positions. If you get drastically different measurements at different listening positions, you may need to reposition various loudspeakers or change the amount of power applied to some of them.

Bear in mind that an analyzer “listening” to pink noise is no substitute for the human ear listening to actual program material. A perfectly flat frequency response is not necessarily the best *sounding* frequency response, so, once you have used the RTA and the S curve 231 to tune a room “by the numbers” be sure to audition the results by playing typical audio signal (music, speech, etc.) through your system and continue to fine tune by ear. Be prepared to compromise—and if there’s a discrepancy between what the RTA says and what your own ears tell you, always go with the latter.

Using the S curve 231 to Remove Feedback

One of the most important applications for the S curve 231 is removing feedback from an onstage monitor system. This procedure is sometimes called “ringing out,” since feedback usually begins with a slight ringing sound at the resonant frequencies where the loop between microphone and speaker is loudest. The advanced Constant Q circuitry ensures that adjacent program frequencies which may not be causing any problems are unaffected even when attenuating problem frequencies by their maximum amount.

To ring out a monitor system, start by setting up the stage exactly as it will be used during performance, preferably with the performers themselves standing in front of the mics they will be using (this is important since the physical placement of objects—or people—on the stage can affect the generation of feedback loops in different frequency areas). With power to all audio components turned off, connect the S curve 231 to the monitor mixer, preferably at its main mix inserts (if these are not available, connect the unit in-line, between the monitor mixer outputs and the monitor amplifier inputs). (See pages 8-10 in this manual for typical configuration diagrams.) Because you'll only be cutting frequencies, press the Cut Only switch so that it is on (in the down position). Also, because you'll want to be able to make deep cuts, set the Range switch so it is off (in the 12dB position). Then raise all front panel Equalizer sliders to their upper-most position; because the Cut Only switch is on, this represents flat response (no cut or boost).

Next, power up all audio equipment (turning on the amplifiers last) and, using one monitor output only, gradually turn up the volume while a performer is speaking or singing into the primary mic for that monitor. Continue slowly increasing the volume until a feedback howl just begins. Using your ears or an RTA (Real Time Analyzer), identify the approximate frequency at which this feedback occurs. Lower the corresponding Equalizer slider until the feedback disappears. Then continue slowly turning up the volume until another feedback howl just begins. Again identify the approximate frequency of this feedback and lower the corresponding Equalizer slider until the feedback disappears. Repeat this procedure until you reach the point where many different frequencies begin to feedback at once or when you find that you've already attenuated most of the feedback frequencies that are occurring. This is the point at which the process stops—you've gotten as much gain out of the monitor system as you can without adjusting the physical placement of the mic or monitor speaker. Repeat this procedure for each monitor output (each time using the primary mic for that monitor).

When done successfully, “ringing out” (which should be done before every performance) can add another 3 to 15 dB more of usable gain to your monitor system—so it's well worth the time and effort!

S curve 231 Wiring Guide

S curve 231 Wiring Guide

There are several ways to interface the S curve 231, depending on your exact monitoring set-up. Follow the cable diagrams below for connecting your monitor system.

1/4" TRS Insert Cable

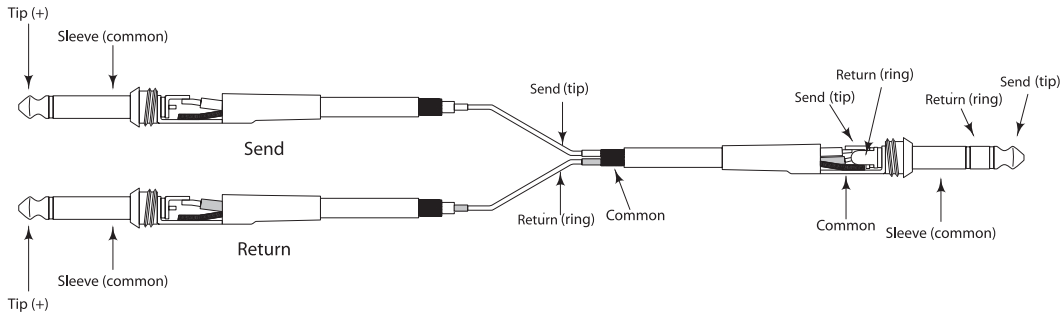

Un-Balanced 1/4" to 1/4" Cable

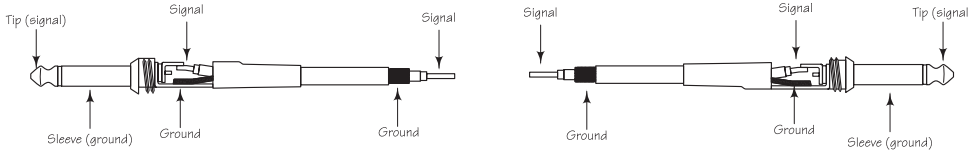

Balanced 1/4" to 1/4" Cable

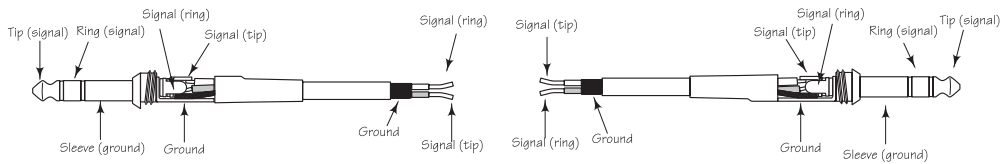

Balanced XLR to XLR Cable

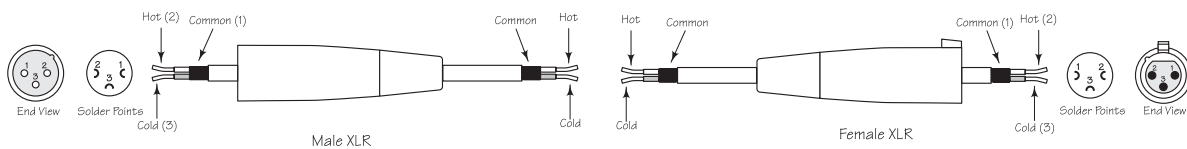

Unbalanced 1/4" to RCA Cable

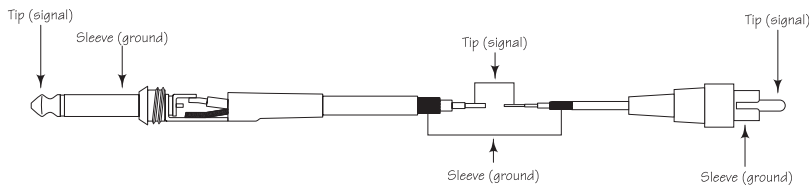

Specifications

1: Center frequencies (Hz)	20, 25, 31.5, 40, 50, 63, 80, 100, 125, 160, 200, 250, 315, 400, 500, 630, 800, 1 k, 1.25 k, 1.6 k, 2 k, 2.5 k, 3.15 k, 4 k, 5 k, 6.3 k, 8 k, 10 k, 12.5 k, 16 k, 20 k
2: Variable range	±6 dB or ±12 dB
3: Frequency response (unity)	<10 Hz to 70 kHz -3 dB
4: THD+N, unity gain (20Hz to 20kHz)	Less than 0.013%
5: Main level Max. gain	+6 dB
6: Low cut filter	variable, 15 to 200 Hz
7: Noise (with 22 kHz LPF, all faders flat)	-85 dB
8: Cut Only mode	-12 dB ± 1 dB Max
9: Dimensions	19 in. (w) x 10.5 (d) x 3.5 (h) 482 mm (w) x 267 (d) x 89 (h)
10: Weight	5.1 lb.(2.31 kg)

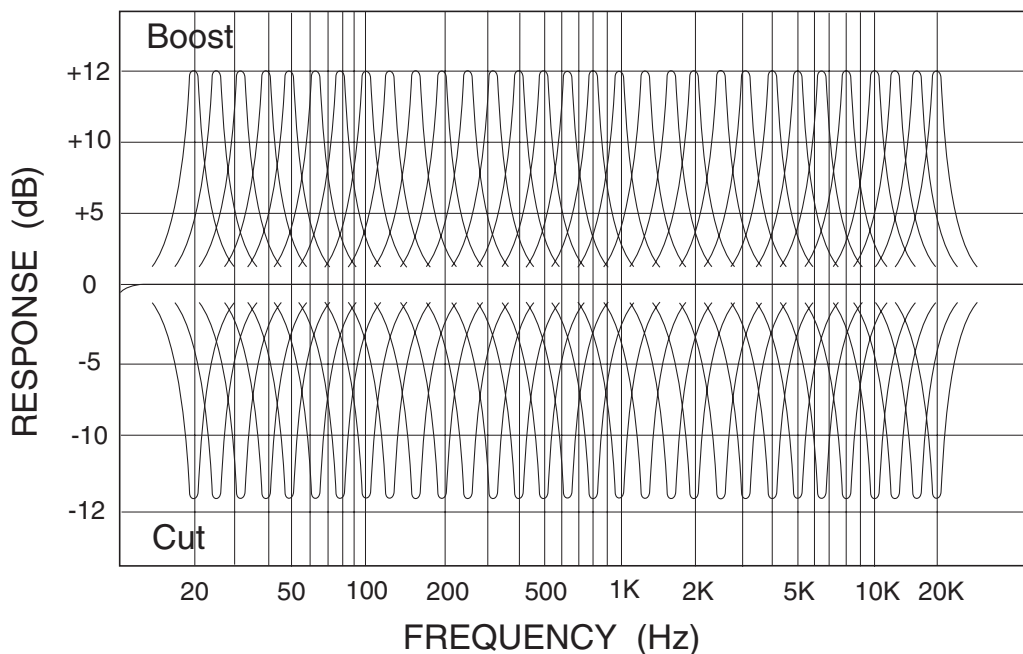

S curve 231 Block Diagram

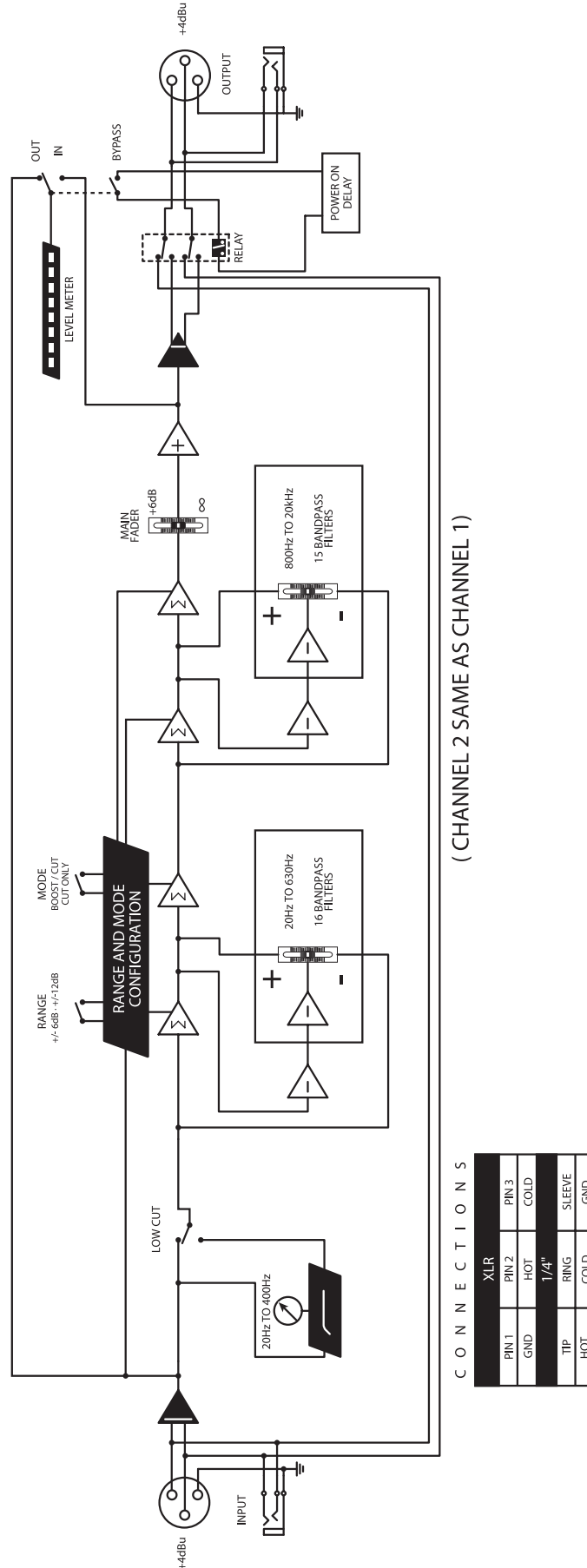

Samson Technologies Corp.
575 Underhill Blvd.
P.O. Box 9031
Syosset, NY 11791-9031
Phone: 1-800-3-SAMSON (1-800-372-6766)
Fax: 516-364-3888
www.samsontech.com

Free Manuals Download Website

<http://myh66.com>

<http://usermanuals.us>

<http://www.somanuals.com>

<http://www.4manuals.cc>

<http://www.manual-lib.com>

<http://www.404manual.com>

<http://www.luxmanual.com>

<http://aubethermostatmanual.com>

Golf course search by state

<http://golfingnear.com>

Email search by domain

<http://emailbydomain.com>

Auto manuals search

<http://auto.somanuals.com>

TV manuals search

<http://tv.somanuals.com>