

PowerBrite Pro PowerBrite PowerStrip



PBPR07



PB9



PS9

OWNERS MANUAL

SAMSON[®]

Table of Contents

Introduction	3
System Features	4
Guided Tour - PS9 Front Panel	5
Guided Tour - PS9 Rear Panel	6
Guided Tour - PB9 Front Panel	7
Guided Tour - PB9 Rear Panel	8
Guided Tour - Pro7 Front Panel	9
Guided Tour - Pro7 Rear Panel	10
Setting Up and Using Your PowerStrip or PowerBrite	11
Changing the PowerBrite Bulb	12
Specifications	13
Appendix A: Fluorescent Or Incandescent?	14
Ordering a Custom Nameplate	15
Changing the PowerBrite Nameplate	16

Produced by *On The Right Wavelength* for Samson Technologies Corp.

Copyright 1997, 1998, Samson Technologies Corp.

Printed March, 1998

Samson Technologies Corp.
575 Underhill Blvd.
P.O. Box 9031
Syosset, NY 11791-9031
Phone: 1-800-3-SAMSON (1-800-372-6766)
Fax: 516-364-3888

Introduction

Congratulations on purchasing your Samson PowerStrip, PowerBrite, or PowerBrite Pro! This manual covers three products: the PowerStrip PS9; the PowerBrite PB9; and the PowerBrite Pro7. All three of these single-space rack units provide multiple outlets for reliable power distribution with 3-point surge and peak protection, plus RF (Radio Frequency) filtering. The three products differ in that the PowerBrite and PowerBrite Pro also provide a front-panel 4 watt fluorescent light (tucked away in a lockable slide-out drawer) which can be used to fully illuminate your entire rack of gear. The PowerBrite Pro7 also provides a rear-panel 12 volt DC lamp connector and a front-panel voltmeter and ammeter. In addition, both the PowerBrite PB9 and PowerBrite Pro7 allow you to substitute your own custom facility logo or band name in the front panel inlay. (See the inside back cover of this manual for more information.)

In this manual, you'll find a more detailed description of the features of your PowerStrip PS9, PowerBrite PB9, or PowerBrite Pro7, as well as instructions for its use and complete specifications. You'll also find a warranty card enclosed—don't forget to fill it out and mail it in! This will enable you to receive online technical support and will allow us to send you updated information about other Samson products in the future.

SPECIAL NOTE: Should your PowerStrip PS9, PowerBrite PB9, or PowerBrite Pro7 ever require servicing, a *Return Authorization* number (RA) is necessary. Without this number, the unit will not be accepted. If purchased in the United States, please call Samson at (516) 364-2244 for a Return Authorization number prior to shipping the unit. If purchased outside the U.S., contact your local Samson dealer for details. Please retain the original packing material and, if possible, return the unit in its original carton and packing materials.

WARNING: Though the PowerStrip PS9, PowerBrite PB9, and PowerBrite Pro7 all provide both surge and peak protection, they are not designed to protect against major overload situations such as lightning strikes or connection to incorrect voltage supplies. In the event of either occurrence, unplug all connected equipment immediately and have your PowerStrip PS9, PowerBrite PB9, or PowerBrite Pro7 evaluated by Samson Technical Support or by an authorized Samson service center before using it again.

System Features

The Samson PowerStrip PS9, PowerBrite PB9, and PowerBrite Pro7 all utilize state-of-the-art technology in power distribution and are engineered to the finest detail. Here are some of their main features:

- Multiple switched rear-panel AC outlets (eight in the PowerStrip PS9 and PowerBrite PB9; six in the PowerBrite Pro7) that allow you to power an entire rack's worth of gear from one source. In addition, an unswitched front-panel convenience outlet is provided for temporary power needs (such as plugging in a guitar amplifier, soldering iron, etc.).
- Rear-panel switched outlets are mounted both vertically and horizontally to accommodate standard 3-pin plugs as well as external transformer AC power adapters.
- 3-point surge protection, peak clamping protection and RF filtering enables all connected equipment to operate with maximum efficiency and minimal noise.
- Front-panel resettable 15 amp circuit breaker protects all connected gear.
- An independent dedicated switch with status light for powering the rear-panel switched outlets.
- In the PowerBrite PB9 and PowerBrite Pro7, a lockable slide-out drawer contains a standard 4 watt fluorescent bulb (similar to that used in many desktop lamps and readily available at most hardware stores and electrical suppliers) that fully illuminates all gear underneath with cool, clear light. In addition, there is a dedicated switch (with status light) for turning on the bulb. The front-panel light features a backlit customizable inlay with a Samson logo—and our unique “Neo-Rack” service (see the back cover of this manual) allows you to substitute your own custom facility or band logo design.
- In the PowerBrite Pro7, a rear-panel 12-volt XLR connector (for Littlite®-compatible lamps), and a front-panel voltmeter and ammeter that allow you to monitor changes in the current drawn from both switched and unswitched outlets.
- All units are designed to be mounted in the top slot of any standard 19" rack, taking only a single rack space.
- Rugged construction that makes the Samson PowerStrip PS9, PowerBrite PB9, and PowerBrite Pro7 eminently roadworthy.

Guided Tour - PowerStrip PS9 Front Panel

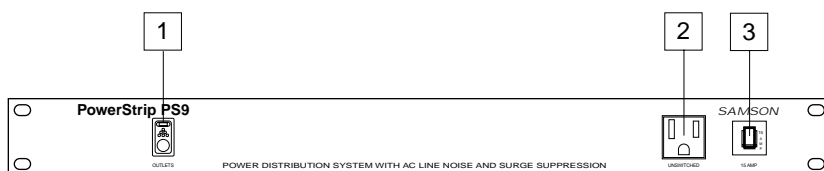

1: Outlets switch - Use this to turn the rear-panel outlets on or off. When on, the status light inside this switch is lit red.

2: Unswitched convenience outlet - This 3-pin AC outlet is active whenever the PS9 is plugged in, regardless of the setting of the Outlets switch (see #1 above).

3: Circuit breaker- This circuit breaker will trip whenever the total load on the PS9 (all rear-panel switched outlets plus the front-panel unswitched convenience outlet) exceeds 15 amps. To reset it, unplug one or more devices so as to reduce the load and gently press the circuit breaker in until you hear it click.

Guided Tour - PowerStrip PS9 Rear Panel

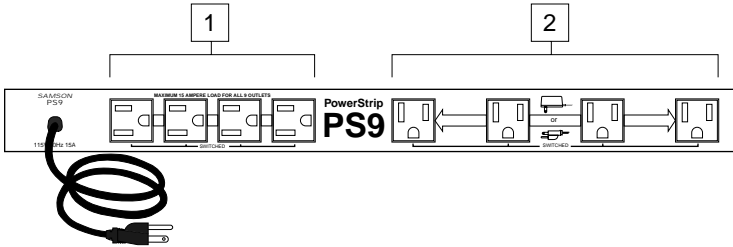

1: Switched AC outlets (horizontal mount) - Connect external equipment to these standard 3-pin AC outlets, which are turned on and off from the front panel Outlets switch (see #2 on the previous page).

2: Switched AC outlets (vertical mount) - Similar to the AC outlets described in #1 above, these are mounted vertically so as to accommodate external transformer AC power adapters.

Guided Tour - PowerBrite PB9 Front Panel

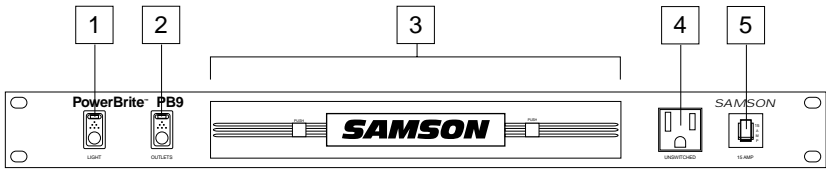

1: Light switch - Use this to turn the fluorescent light in the slide-out drawer on or off. When on, the LED inside this switch lights red.

2: Outlets switch - Use this to turn the rear-panel outlets on or off. When on, the LED inside this switch lights red.

3: Slide-out drawer - Contains the PowerBrite's fluorescent light, clear plastic diamond lens and back-lit inlay. Use both fingers to press gently on the two "Push" squares on the front and the drawer will slide out towards you. Use the Light switch (see #1 above) to turn the light on or off. The light uses a standard 4 watt fluorescent bulb which is readily available at most hardware stores or electrical suppliers (see page 10 in this manual for information on how to change the bulb). To lock the drawer back into place, gently slide the drawer back in (again using both fingers on the "Push" squares) until it clicks. See the inside back cover of this manual for information about our "Neo-Rack" service which allows the inlay to be replaced with a custom facility logo or name.

4: Unswitched convenience outlet - This 3-pin AC outlet is active whenever the PB9 is plugged in, regardless of the setting of the Outlets switch (see #2 above).

5: Circuit breaker- This circuit breaker will trip whenever the total load on the PB9 (all rear-panel switched outlets plus the front-panel unswitched convenience outlet) exceeds 15 amps. To reset it, unplug one or more devices so as to reduce the load and gently press the circuit breaker in until you hear it click.

Guided Tour - PowerBrite PB9 Rear Panel

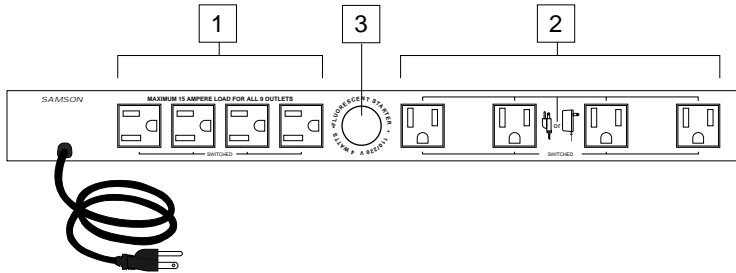

1: Switched AC outlets (horizontal mount) - Connect external equipment to these standard 3-pin AC outlets, which are turned on and off from the front panel Outlets switch (see #2 on the previous page).

2: Switched AC outlets (vertical mount) - Similar to the AC outlets described in #1 above, these are mounted vertically so as to accommodate external transformer AC power adapters.

3: Fluorescent starter - This is a standard 4 watt, 110 volt condenser type fluorescent starter, used for starting the fluorescent light in the slide-out drawer (see #3 on the previous page). To remove the starter, twist it counterclockwise a half-turn and pull it straight out. To insert a new starter, line up its pins with the slot and twist it a half-turn in the other direction. Be certain the replacement starter is rated at 4 watts or greater.

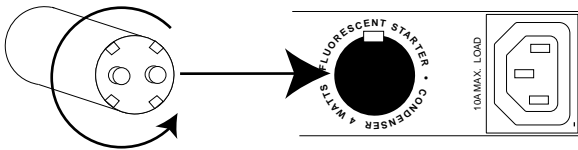

Guided Tour - PowerBrite Pro7 Front Panel

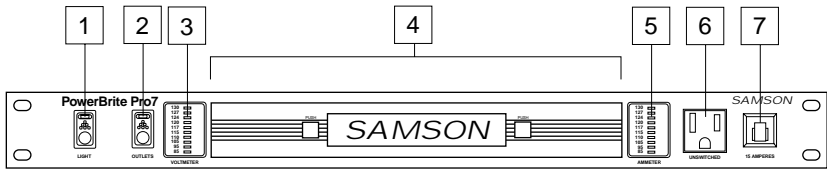

1: Light switch - Use this to turn the fluorescent light in the slide-out drawer on or off. When on, the status light inside this switch is lit red.

2: Outlets switch - Use this to turn the rear-panel outlets on or off. When on, the status light inside this switch is lit red.

3: Voltmeter - This ten-stage LED meter shows the amount of voltage in the electrical signal being received by the PowerBrite Pro7.

WARNING: Severe voltage swings can cause damage to connected equipment. If you see the voltmeter changing drastically or rapidly, disconnect the Pro7 until the source of the problem is identified.

4: Slide-out drawer - Contains the Pro7's fluorescent light, clear plastic diamond lens and back-lit inlay. Use both fingers to press gently on the two "Push" squares on the front and the drawer will slide out towards you. Use the Light switch (see #1 above) to turn the light on or off. The light uses a standard 4 watt fluorescent bulb which is readily available at most hardware stores or electrical suppliers (see page 10 in this manual for information on how to change the bulb). To lock the drawer back into place, gently slide the drawer back in (again using both fingers on the "Push" squares) until it clicks. See the inside back cover of this manual for information about our "Neo-Rack" service which allows the inlay to be replaced with a custom facility logo or name.

5: Ammeter - This ten-stage LED meter shows the amount of current being drawn by equipment connected to the PB Pro7. **WARNING:** Severe current swings can cause damage to connected equipment. If you see the ammeter changing drastically or rapidly, disconnect the PB Pro7 until the source of the problem is identified and repaired

6: Unswitched convenience outlet - This 3-pin AC outlet is active whenever the PB Pro7 is plugged in, regardless of the setting of the Outlets switch (see #2 above).

7: Circuit breaker- This circuit breaker will trip whenever the total load on the PB Pro7 (all rear-panel switched outlets plus the front-panel unswitched convenience outlet) exceeds 15 amps. To reset it, unplug one or more devices so as to reduce the load and gently press the circuit breaker in until you hear it click.

Guided Tour - PowerBrite Pro7 Rear Panel

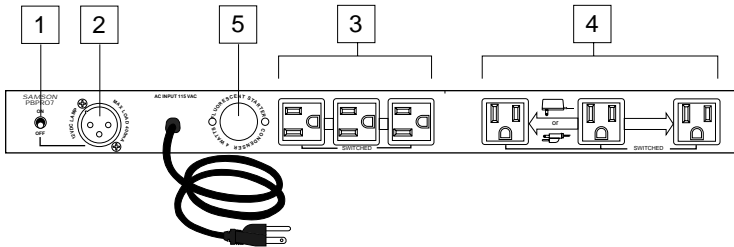

1: Lamp switch - Used to turn on or off a connected Littlite®-compatible lamp (see #2 below).

2: Lamp connector - If required, you can connect a Littlite®-compatible lamp to this 12 VDC female XLR jack.

3: Switched AC outlets (horizontal mount) - Connect external equipment to these standard 3-pin AC outlets, which are turned on and off from the front panel Outlets switch (see #2 on the previous page).

4: Switched AC outlets (vertical mount) - Similar to the AC outlets described in #3 above, these are mounted vertically so as to accommodate external transformer AC power adapters.

5: Fluorescent starter - This is a standard 4 watt, 110 volt condenser type fluorescent starter, used for starting the fluorescent light in the slide-out drawer (see #3 on the previous page). To remove the starter, twist it counterclockwise a half-turn and pull it straight out. To insert a new starter, line up its pins with the slot and twist it a half-turn in the other direction. Be certain the replacement starter is rated at 4 watts or greater.

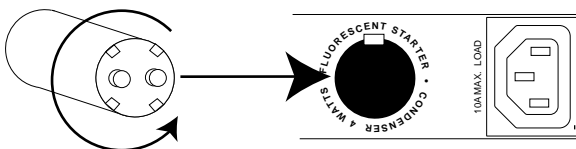

Setting Up and Using Your PowerStrip or PowerBrite

Setting up your PS9, PB9, or Pro7 is a simple procedure which takes only a few minutes:

1. Remove all packing materials (save them in case of need for future service) and install the unit in a standard 19" rack. We recommend that the PB9 and Pro7 be placed in the top slot so that its slide-out fluorescent light can be used to illuminate the entire rack of equipment below.
2. Connect the PS9, PB9, or Pro7 to any standard grounded AC outlet. If you are using a Pro7, the front-panel voltmeter and ammeter will show you the incoming electrical voltage and current draw of connected equipment.
3. Connect the AC cables of your rack equipment to the rear-panel switched AC outlets, using the vertically mounted receptacles for external AC transformer power adapters.

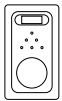

OUTLETS



15 AMP

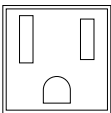

UNSWITCHED

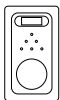

LIGHT

4. Make sure all connected equipment is switched off, then press the front-panel Outlets switch so that its status light is lit red. This activates all rear-panel switched outlets.
5. Turn on all connected equipment, one at a time. If the total load exceeds 15 amps, the front-panel circuit breaker will trip. To reset it, unplug one or more devices, then press in the front-panel circuit breaker.
6. You can also use the unswitched front-panel convenience outlet for additional temporary power needs (such as connecting a guitar amplifier, soldering iron, etc.). This outlet is fully operational whenever the PS9, PB9, or Pro7 is plugged into an AC source, regardless of the position of the front-panel Outlets switch. The front-panel circuit breaker affects this outlet as well as all rear-panel switched outlets.

7. (PB9 and Pro7 only) To illuminate the equipment in your rack, push gently on the front-panel slide-out drawer and it will extend out towards you; then press the front-panel Light switch so that its status light is lit red. If you are using a Pro7, you can illuminate the back of your rack by connecting a Littlite®-compatible lamp to the rear-panel 12 VDC socket.

If you encounter difficulty with any aspect of setting up or using your PS9, PB9, or Pro7, call Samson Technical Support (1-800-372-6766) between 9 AM and 5 PM EST.

Changing the PowerBrite Bulb

The 4-watt fluorescent bulb in your PowerBrite PB9 and Pro7 is rated to deliver approximately 3,000 hours of operation. That's a long time, to be sure, but there will probably come a time when you'll need to replace it. The good news is that the bulb itself is readily available at most hardware stores and electrical supply houses—the type number is "F4T5CW"—and you can replace it yourself in less than a minute with just a small flat-head screwdriver (a jeweler's screwdriver is ideal).

Begin by unplugging your PB9 or Pro7 and then unplug all devices connected to the rear and/or front panel outlets. Then remove the PowerBrite from your rack and use both fingers to press gently on the two "Push" squares on the slide-out drawer so that it extends out towards you. With the drawer extended, turn the PowerBrite upside down. The illustration below shows how to remove the clear plastic diamond lens at the bottom of the drawer: Gently pull back on one of the retaining tabs with your finger and insert the flat-head screwdriver under the clear plastic diamond lens to pry it up and out. Then pull back on the other retaining tab with your finger and remove the lens.

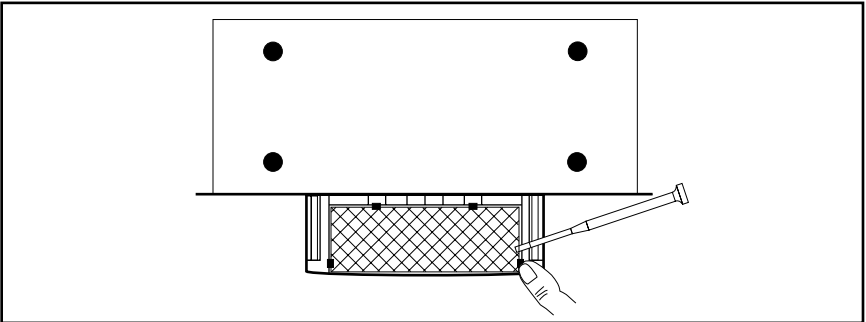

The bulb is now easily removed by giving it a half-turn so that its end terminals line up with the holder slots.

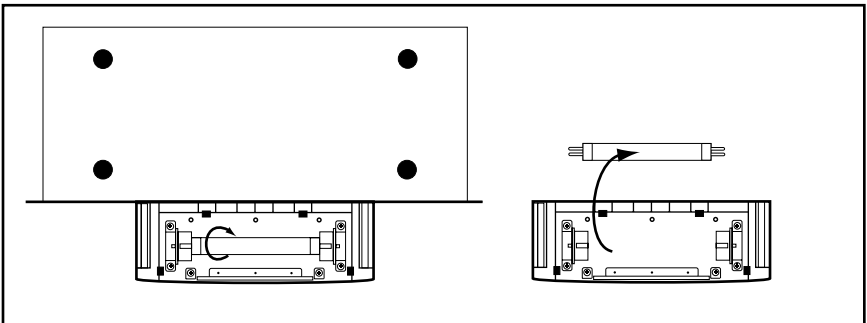

Follow the same procedure to insert a new bulb, then replace the clear plastic diamond lens by pulling gently back on both retaining tabs.

Specifications

Electrical:

Number of Outlets	8 switched, 1 unswitched
PS9 and PB9	6 switched, 1 unswitched
Pro7	15 Amp (circuit breaker protected)
Max. Current	0 to 130 Vac continuous
Input Voltage (RMS)	Hot to Neutral, Hot to Ground, and Neutral to Ground
Spike Protection Mode	340 Vac
Max. Clamping Voltage (@ 50 A)	1 nanosecond
Response Time	4,500 Amps (8 x 20 μ s pulse)
Max. Surge Current	56 Joules
Max. Spike Energy	>20 dB, 1.5 MHz to 200 MHz
Noise Attenuation	Pendant
Power Cord	

Bulb/Starter (PB9 and Pro7 only):

Fluorescent Bulb Type	F4T5CW
Bulb Life (Typical)	3,000 Hours
Lumens	95
Fluorescent Starter	Condenser Type FS2
Starter Fuse (Internal)	(110 Vac, 4 - 20 Watts) 500 milliAmp T-type

General:

Dimensions	19 in. (w) x 7.5 (d) x 3.5 (h) 482 mm (w) x 190 (d) x 88 (h)
Weight	7 lbs. • 3. 2 kg
Conforms	UL and CUL

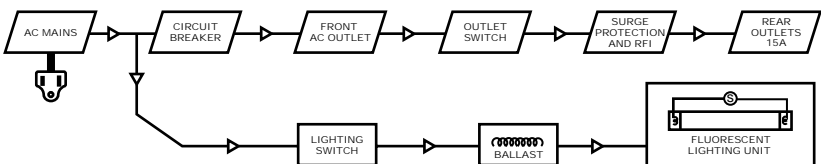

PB9 block diagram

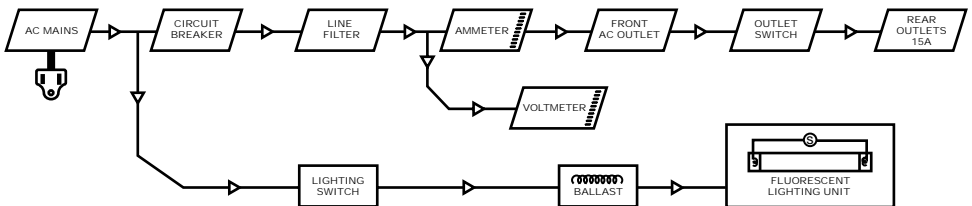

PB Pro7 block diagram

Appendix A:

Fluorescent Or Incandescent?

There are numerous advantages to using the kind of fluorescent lighting provided by the PowerBrite PB9 and PowerBrite Pro7 over the incandescent lighting provided by competing rack light products. Here are the main points to consider when making your purchase:

- Fluorescent bulbs generate almost no heat at all; incandescent bulbs can generate large amounts of heat.
- Fluorescent bulbs last approximately 50% longer than incandescent ones, with a typical life of 3,000 hours (as opposed to incandescent lights, which rarely last more than about 2,000 hours). There are also “long-life” versions of fluorescent bulbs available which operate for even longer periods.
- Fluorescent bulbs are brighter than incandescent ones and they deliver much greater light dispersion. This is due to their longer tube length, which imparts an increased diffusion pattern.
- The quality of fluorescent light is similar to daylight, while incandescent lights impart an artificial glow. There are also a wide variety of fluorescent bulb types readily available from most hardware stores, including “soft glow” and colored bulbs which can impart distinctive lighting effects.
- Fluorescent lighting systems require no dimmers, which are notorious for adding noise. Because of the lack of a dimmer and the heavy silicon steel shielding employed by the internal ballast transformer (which reduces hum by 20 dB), the PowerBrite delivers noise performance similar to that of an incandescent system.
- Taking your rack on the road? Fluorescent bulbs travel better than incandescent ones because the bulb is suspended by both ends of the lamp. In addition, the fluorescent filament is robust and is used only to start the bulb and is then switched off (unlike an incandescent filament, which is much more delicate and must operate continuously).

Ordering a Custom Nameplate

Congratulations and thank you for purchasing the
SAMSON
PowerBrite Pro™ or PowerBrite™



Get Your Nameplate Customized!
 Illuminate any image that will fit within the available space—4 1/8" wide x 3/4" high. Personalize your front nameplate by following the instructions:

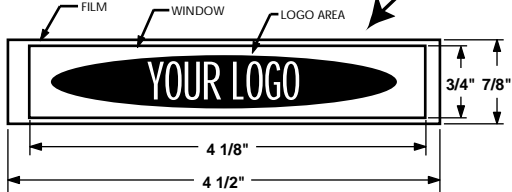

Please choose one of the following options:

- Send us a clear copy of your logo sized to 4 1/8" wide x 3/4" high.
 The logo should be high contrast, i.e. black on white or vice versa. It should be in good scan-able, wrinkle free condition. If a certain font is used please include that information. For best resolution, the logo should not be smaller than 4 1/8 "x 3/4", or larger.
- Logos created on computer can be sent on a 3 1/2" floppy or Zip™ disk in the following formats: BMP, EPS, PICT, TIFF, Illustrator® and Photoshop®.
- Scanned images on disk must have a minimum resolution of 300 D.P.I.
- Any Name that fits easily in the space above (if you don't have a logo, we can use your name).
- Custom Logo: If you need a logo designed, call or write us for information.

All orders must be accompanied by check or money order payable to: Neo-Rack Technology, Inc.
 for: \$8.75 within the United States
 \$10.75 outside the United States
 \$4.95 each additional logo
 (prices include shipping and handling)

Send artwork, check or money order to:

NEO-RACK
 .TECHNOLOGY . INC.

P.O. Box 21124

Baltimore, MD 21228

Phone: (410) 744-6498

email: sales@neorack.com

Allow 4–6 weeks for delivery within the U.S.
 6–9 weeks for delivery outside the U.S.

Prices are subject to change without notice.
 Please call with any formatting questions.

PowerBrite™ Nameplate Order Form

PowerBrite Logo/Name: _____

Company Name: _____

Owner/Manager Name: _____

Address: _____

Tel: _____ Fax: _____

email: _____

Changing the PowerBrite Nameplate

After you have received your new Neo-Rack film, it's a simple matter to install it. Begin by unplugging your PowerBrite and then unplug all devices connected to the rear and/or front panel outlets. Remove the PowerBrite from your rack and use both fingers to press gently on the two "Push" squares on the slide-out drawer so that it extends out towards you. With the drawer extended, turn the PowerBrite upside down. As described on page 10 in this manual, remove the clear plastic diamond lens at the bottom of the drawer. Then, as shown in the illustration below, use a Philips-head screwdriver to remove the two retaining screws holding down the metal nameplate bracket.

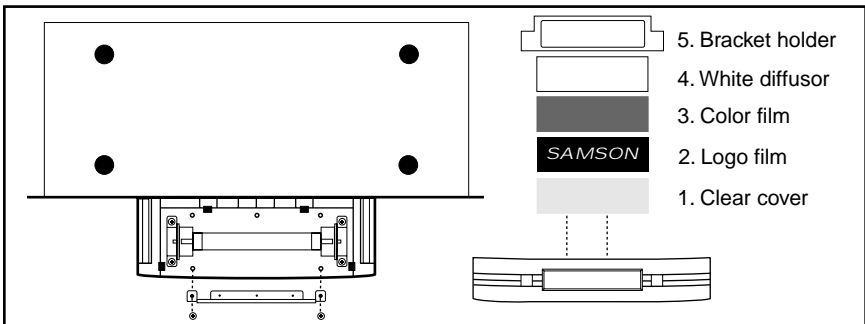

Inside the window you will find a slot that holds a four-layer "sandwich" consisting of a clear cover (#1 in the illustration above, found closest to the window), logo film (#2), color film (#3), and white diffuser (#4). Replace the logo film with your new custom Neo-Rack film (the color film can also optionally be replaced if desired) and then carefully put the layers back together in the same order, taking care to position the logo film correctly (it should be upside-down, since the PowerBrite itself is currently upside-down). Then just slide the "sandwich" back into the slot, replace the nameplate bracket and clear diamond lens and you're done!

Free Manuals Download Website

<http://myh66.com>

<http://usermanuals.us>

<http://www.somanuals.com>

<http://www.4manuals.cc>

<http://www.manual-lib.com>

<http://www.404manual.com>

<http://www.luxmanual.com>

<http://aubethermostatmanual.com>

Golf course search by state

<http://golfingnear.com>

Email search by domain

<http://emailbydomain.com>

Auto manuals search

<http://auto.somanuals.com>

TV manuals search

<http://tv.somanuals.com>