

SAMSUNG

**OWNER'S INSTRUCTIONS
MANUAL DE INSTRUCCIONES
MANUEL D'UTILISATION**

**Cooling only
AFPCC052CA0**

ENGLISH

ESPAÑOL

FRANÇAIS

**System Air Conditioner
Aire acondicionado sistemático
Climatiseur numérique multifonctionnel**

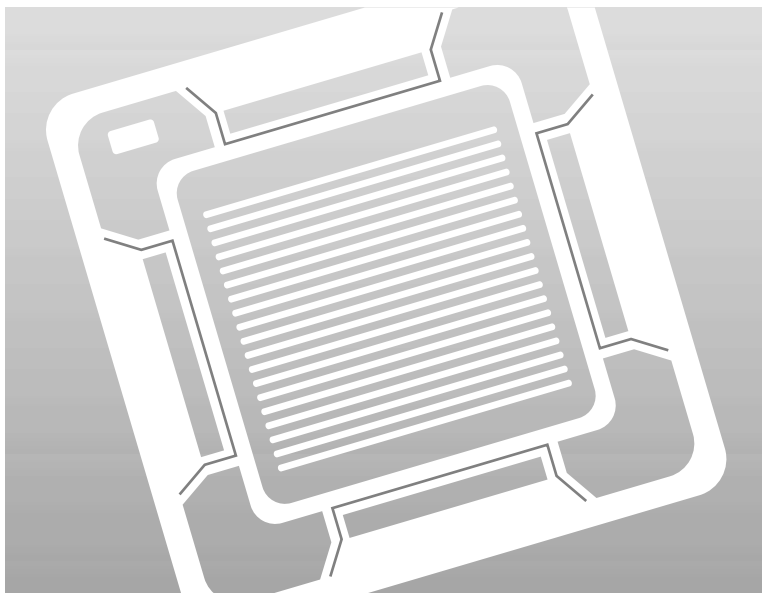

Safety Precautions



WARNING

- ◆ If the power supply cord of this air conditioner is damaged, it must be replaced by the manufacturer or its authorized service personnel only in order to avoid a safety hazard.



DANGER

- ◆ Do not attempt to install this air conditioner by yourself.
- ◆ This unit contains no user-serviceable parts. Always consult authorized service personnel for repairs.
- ◆ When moving, consult authorized service personnel for disconnection and installation of the unit.
- ◆ Do not become over-exposed to cold air by staying in the direct path of the airflow of the air conditioner for extended periods of time.
- ◆ Do not insert fingers or objects into the outlet port or intake grilles.
- ◆ Do not start and stop air conditioner operation by disconnecting the power supply cord and so on.
- ◆ Take care not to damage the power supply cord.
- ◆ In the event of a malfunction (burning smell, etc.), immediately stop operation, turn off the electrical breaker, and consult authorized service personnel.



CAUTION

- ◆ Provide occasional ventilation during use.
- ◆ Do not direct air flow at fireplaces or heating apparatus.
- ◆ Do not climb on, or place objects on, the air conditioner.
- ◆ Do not hang objects from the indoor unit.
- ◆ Do not set flower vases or water containers on top of air conditioners.
- ◆ Do not expose the air conditioner directly to water.
- ◆ Do not operate the air conditioner with wet hands.
- ◆ Do not pull power supply cord.
- ◆ Turn off power source when not using the unit for extended periods.
- ◆ Check the condition of the installation stand for damage.
- ◆ Do not place animals or plants in the direct path of the air flow.
- ◆ Do not drink the water drained from the air conditioner.
- ◆ Do not use in applications involving the storage of foods, plants or animals, precision equipment, or art works.
- ◆ Do not apply any heavy pressure to radiator fins.
- ◆ Operate only with air filters installed.
- ◆ Do not block or cover the intake grille and outlet port.
- ◆ Ensure that any electronic equipment is at least one metre away from either the indoor or outdoor units.
- ◆ Avoid installing the air conditioner near a fireplace or other heating apparatus.
- ◆ When installing the indoor and outdoor unit, take precautions to prevent access to infants.
- ◆ Do not use inflammable gases near the air conditioner.
- ◆ Max input power & current is measured according to IEO standard and input power & current is measured according to ISO standard.

Contents

◆ **PREPARING YOUR AIR CONDITIONER**

- Safety Precautions 2
- View of the Unit 4
- Wireless Remote Controller-Buttons and Display 6
- Wired Remote Controller-Buttons and Display 7
- Centralized Controller 8
- Getting Start 9
- Inserting the Wireless Remote Controller Batteries 10

USING WIRELESS REMOTE CONTROLLER

◆ **OPERATING YOUR AIR CONDITIONER**

- Selecting the Automatic Operating Mode 12
- Cooling Your Room 13
- Heating Your Room (Except Cooling Only Models) 14
- Removing Excess Humidity 15
- Airing Your Room 16
- Adjusting the Air Flow Direction 17

◆ **PROGRAMMING YOUR AIR CONDITIONER**

- Setting the On Timer 18
- Setting the Off Timer 19

USING WIRED REMOTE CONTROLLER

◆ **OPERATING YOUR AIR CONDITIONER**

- Selecting the Automatic Operating Mode 21
- Cooling Your Room 22
- Heating Your Room (Except Cooling Only Models) 23
- Removing Excess Humidity 24
- Airing Your Room 25
- Adjusting the Air Flow Direction 25

◆ **PROGRAMMING YOUR AIR CONDITIONER**

- Setting the On Timer 26
- Setting the Off Timer 27

USING CENTRALIZED CONTROLLER

- Using the Centralized Controller 28

◆ **RECOMMENDATIONS FOR USE**

- Operating Recommendations 29
- Temperature and Humidity Ranges 30
- Cleaning Your Air Conditioner 31
- Bio-Pure Filter Installation (Optional) 32
- Solving Common Problems 33

◆ **TECHNICAL SPECIFICATIONS**

View of the Unit

The figures are shown in this instruction may differ from yours depending on the model.

Indoor Unit

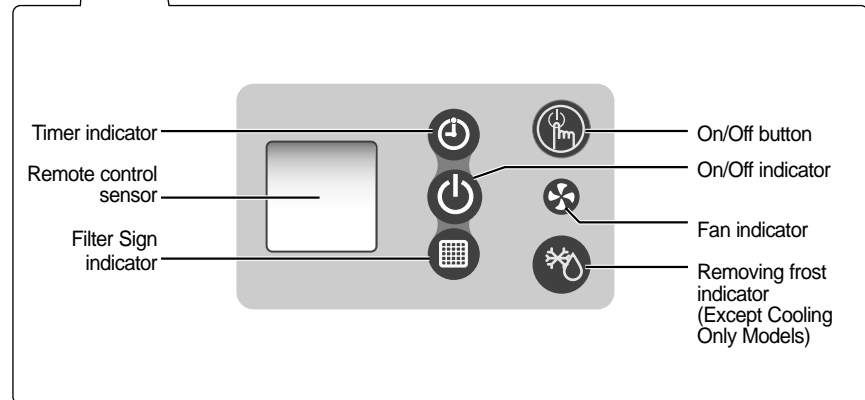
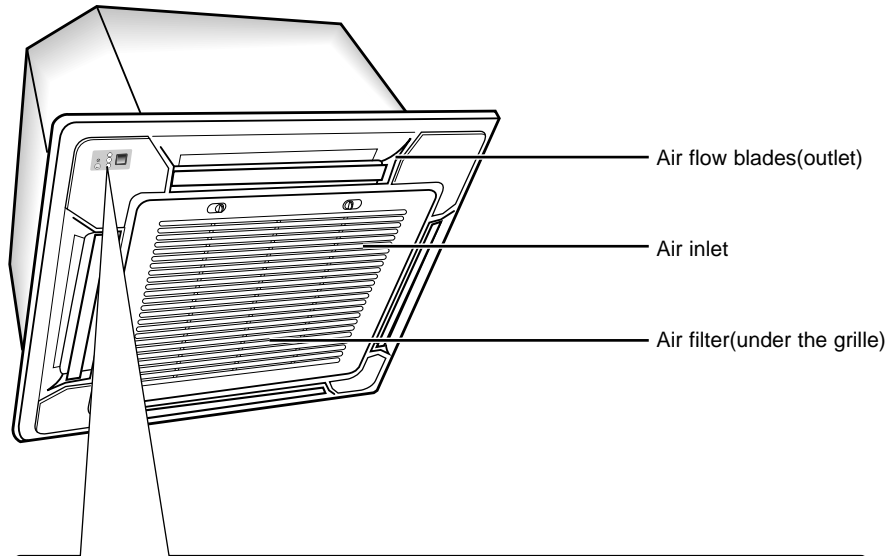

Outdoor Unit

TYPE A

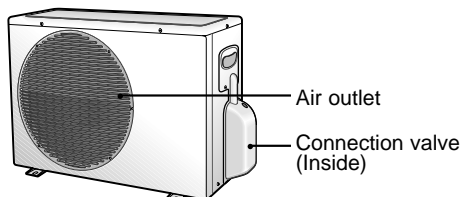

Outdoor Unit

TYPE B

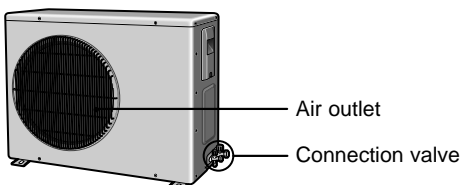

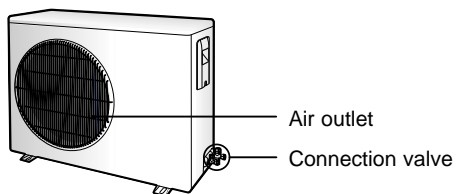
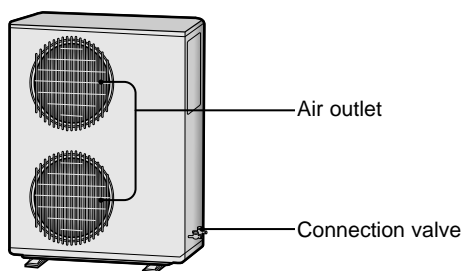
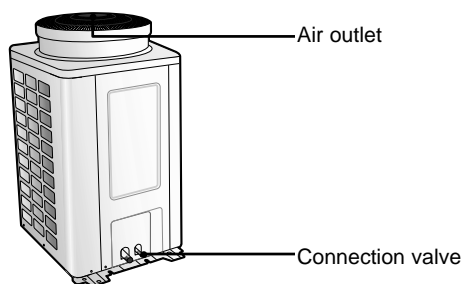
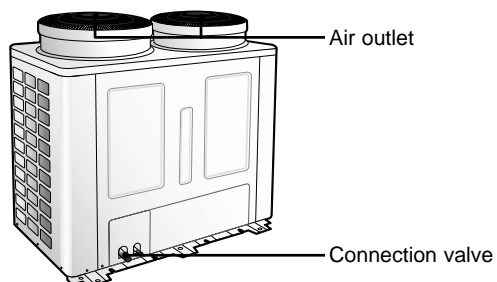
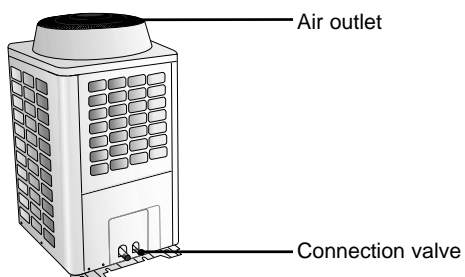
Outdoor Unit TYPE C**Outdoor Unit** TYPE D**Outdoor Unit** TYPE E**Outdoor Unit** TYPE F**Outdoor Unit** TYPE G

Note If the heat exchanger in the outdoor unit gets dusty, cooling efficiency may fall. So clean the heat exchanger with water when it becomes dirty. However, be careful when you wash the surface of the heat exchanger because it is very sharp.

Wireless Remote Controller-Buttons and Display

The wireless remote controller is an optional accessory.

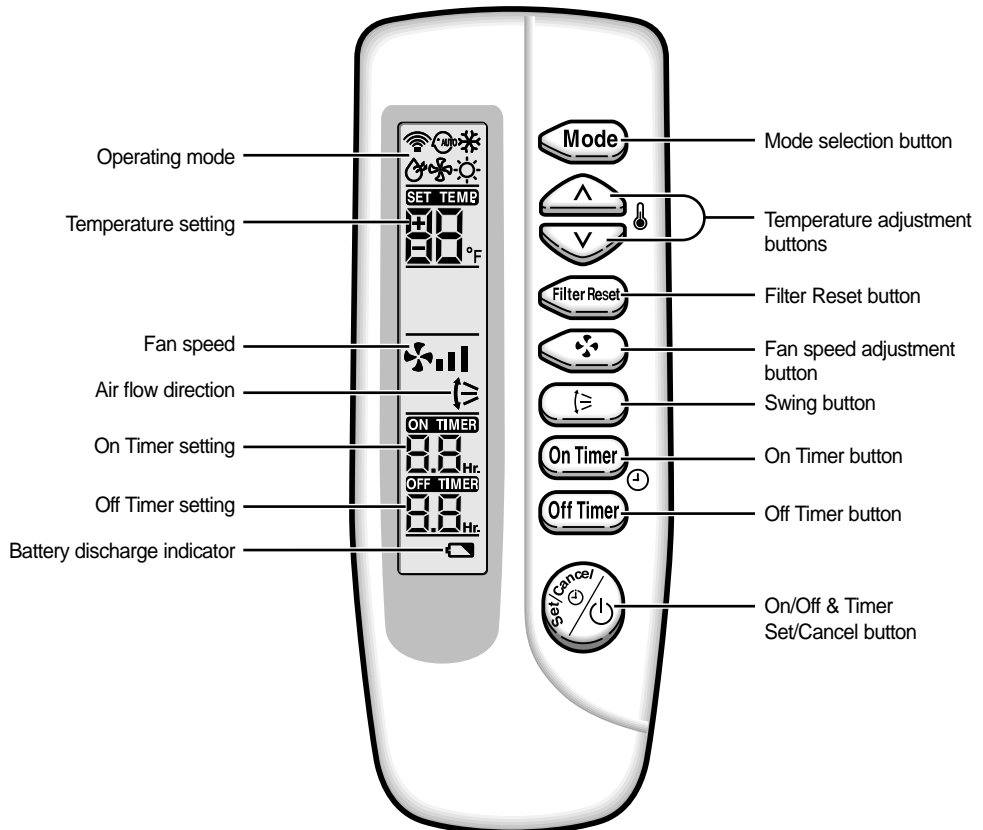

- Note**
- After cleaning the air filter, press the filter reset button.
 - The heating mode(☀) is not selected in cooling only models.

Wired Remote Controller-Buttons and Display

The wired remote controller is an optional accessory and it is installed on the wall.

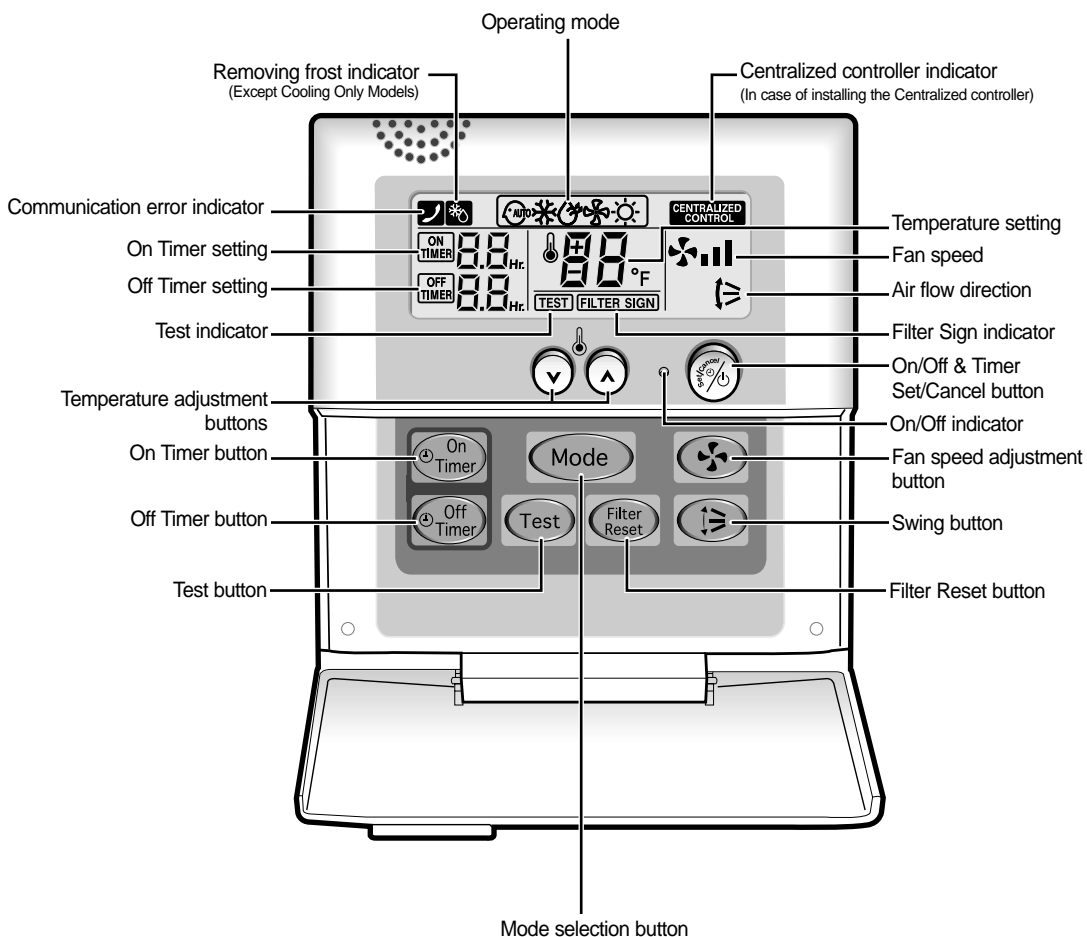

- Note**
- Test button is for your installation specialist. You must NOT press it.
 - After cleaning the air filter, press the filter reset button. Then the wired remote controller will display the FILTER SIGN indicator when the time to clean the air filter; refer to page 31.
 - The heating mode(☀) is not selected in cooling only models.

Centralized Controller

The centralized controller is an optional accessory and it is installed on the wall.

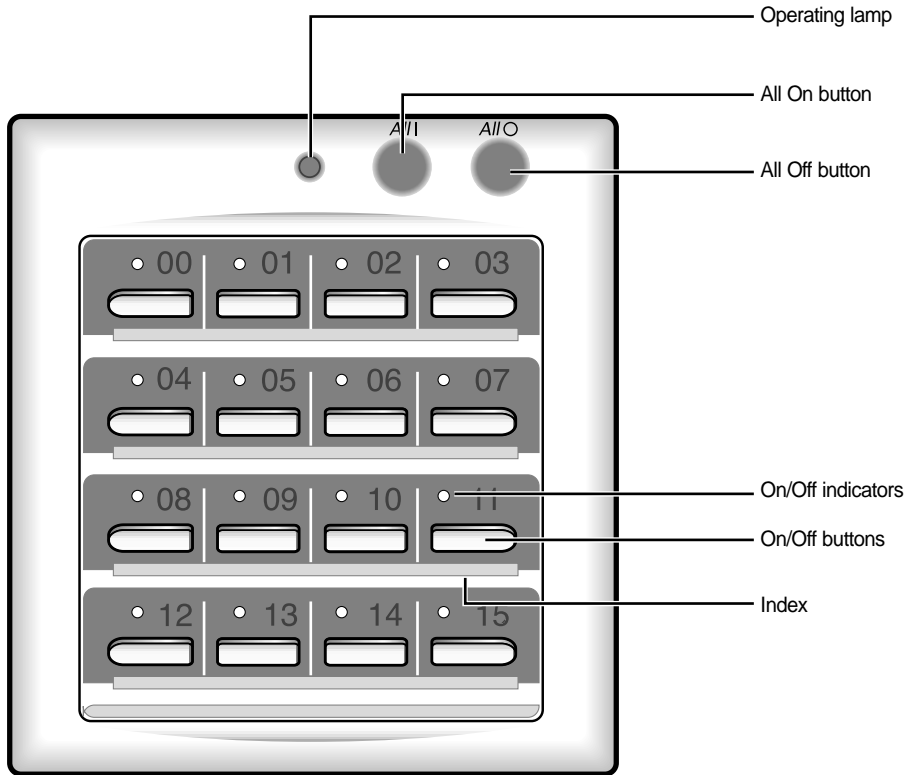

Note Operating lamp comes on when at least one air conditioner connected to the centralized controller is operating.

Getting Start

You have just purchased a system type air conditioner and it has been installed by your installation specialist.

Your Owner's Instructions contain much valuable information on using your air conditioner. Please take the time to read them as they will help you take full advantage of the unit's features.

The booklet is organized as follows.

- ◆ *The following figures are shown on pages from 4 to 8 :*
 - *Indoor and outdoor units*
 - *Wireless remote controller (buttons and display)*
 - *Wired remote controller (buttons and display)*
 - *Centralized controller*

- ◆ *In the main part of the document, you will find a series of step-by-step procedures for each function available.*

The illustrations in the step-by-step procedures use three different symbols:

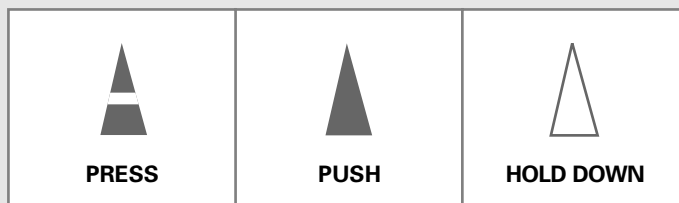

Inserting the Wireless Remote Controller Batteries

You must insert or replace the remote controller batteries when :

- ◆ **You purchase the air conditioner**
- ◆ **The remote controller does not work correctly**

Note

- ◆ Use two AAA, LR03 1.5V batteries.
- ◆ Do not use old batteries or different kinds of batteries together.
- ◆ Batteries may be completely discharged after 12 months, even if they have not actually been used.

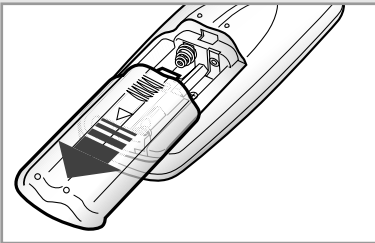

- 1 Push the battery cover on the rear of the remote controller with your thumb in the direction of the arrow and remove it.

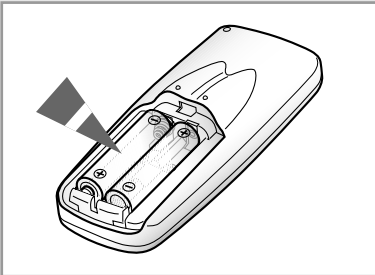

- 2 Insert the two batteries, taking care to respect the polarities :
 - ◆ + on the battery with + on the remote controller.
 - ◆ - on the battery with - on the remote controller.

- 3 Close the cover by sliding it back until it clicks into place.

Using Wireless Remote Controller

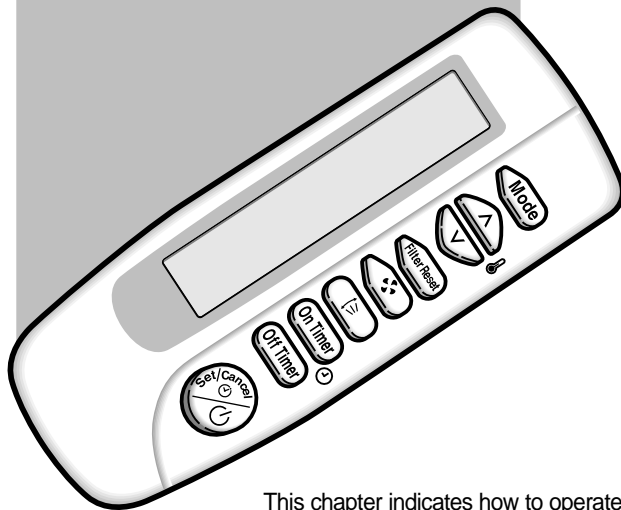

This chapter indicates how to operate and program your air conditioner with the wireless remote controller. The wireless remote controller is an optional accessory.

Selecting the Automatic Operation Mode

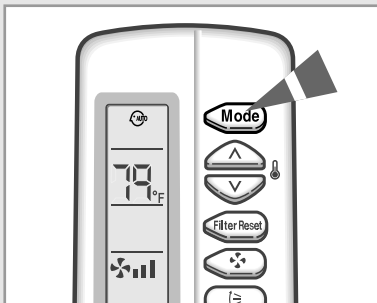
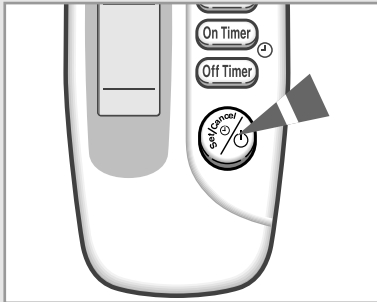

In the Automatic mode, the room temperature and the fan speed are controlled automatically.

- 1 If necessary, press  (ON/OFF) button.

Result:

- ◆ The On/Off indicator on the indoor unit comes on.
- ◆ The air conditioner runs in the mode selected when the unit was last used.
- ◆ The indoor unit beeps.

IMPORTANT The air conditioner is fitted with a protection mechanism to prevent the unit from being damaged when it is started immediately after being:

- ◆ Plugged in
- ◆ Stopped

It will start up normally after three minutes.

- 2 To select the AUTO mode, press the Mode button until  is displayed at the top of the wireless remote controller.

Result:

- ◆ The indoor unit beeps.
- ◆ The air conditioner runs in AUTO mode.

Note You can change modes at any time.

- 3 To adjust the temperature, press the Temperature buttons one or more times until the required temperature is displayed. Possible temperatures are between 65°F and 86°F inclusive.

Result:

- ◆ Each time you press Temperature buttons:
 - The temperature is adjusted by 1°F.
- ◆ The air conditioner starts cooling, provided that the room temperature is higher than the selected temperature. The quantity of air is adjusted automatically.

Cooling Your Room

You must select the **COOL** mode if you wish to adjust the :

- ◆ **Cooling temperature**
- ◆ **Fan speed when cooling**

1 If necessary, press (ON/OFF) button.

- Result:**
- ◆ The On/Off indicator on the indoor unit comes on.
 - ◆ The air conditioner runs in the mode selected when the unit was last used.
 - ◆ The indoor unit beeps.

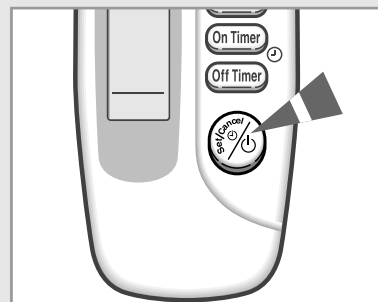

IMPORTANT The air conditioner is fitted with a protection mechanism to prevent the unit from being damaged when it is started immediately after being:

- ◆ Plugged in
 - ◆ Stopped
- It will start up normally after three minutes.

2 To select the COOL mode, press the Mode button until is displayed at the top of the wireless remote controller.

- Result:**
- ◆ The indoor unit beeps.
 - ◆ The air conditioner runs in COOL mode.

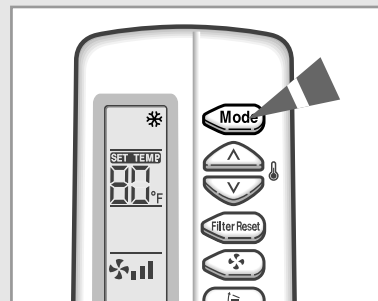

Note You can change modes at any time.

3 To adjust the temperature, press the Temperature buttons one or more times until the required temperature is displayed. Possible temperatures are between 65°F and 86°F inclusive.

- Result:**
- ◆ Each time you press Temperature buttons:
 - The temperature is adjusted by 1°F.
 - The indoor unit beeps.
 - ◆ The air conditioner starts cooling, provided that the room temperature is higher than the selected temperature ; the fan will, however, operate.

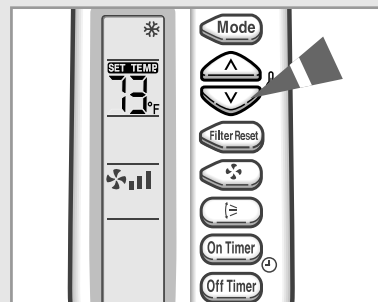

4 Select the fan speed by pressing the Fan button one or more times until the intended value is displayed :

- Automatic (rotated :)
- Low
- Medium
- High

5 To control the direction of the air flow, refer to page 17.

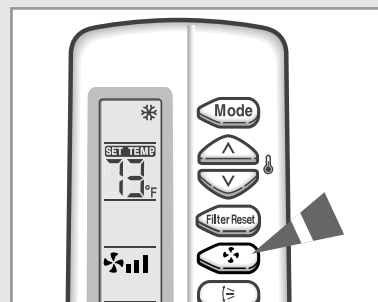

Heating Your Room (Except Cooling Only Models)

You can select the HEAT mode only in heat pump models.

You must select the HEAT mode if you wish to adjust the :

- ◆ Heating temperature
- ◆ Fan speed when heating

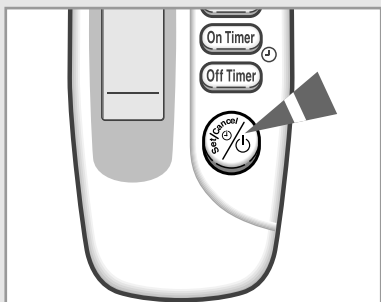

- 1 If necessary, press (ON/OFF) button.

- Result:**
- ◆ The On/Off indicator on the indoor unit comes on.
 - ◆ The air conditioner runs in the mode selected when the unit was last used.
 - ◆ The indoor unit beeps.

IMPORTANT The air conditioner is fitted with a protection mechanism to prevent the unit from being damaged when it is started immediately after being:

- ◆ Plugged in
- ◆ Stopped

It will start up normally after three minutes.

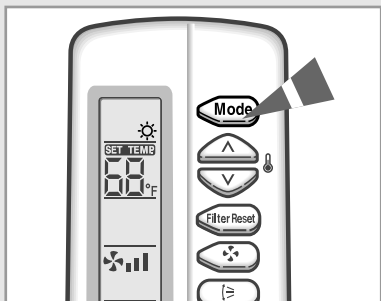

- 2 To select the HEAT mode, press the Mode button until is displayed at the top of the wireless remote controller.

- Result:**
- ◆ The indoor unit beeps.
 - ◆ The air conditioner runs in HEAT mode.

Note You can change modes at any time.

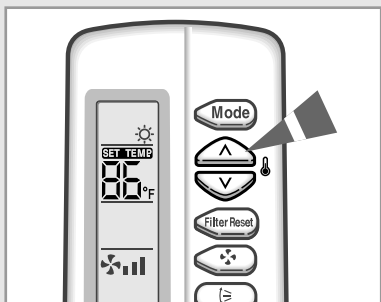

- 3 To adjust the temperature, press the Temperature buttons one or more times until the required temperature is displayed. Possible temperatures are between 61°F and 86°F inclusive.

- Result:**
- ◆ Each time you press Temperature buttons:
 - The temperature is adjusted by 1°F.
 - The indoor unit beeps.
 - ◆ The air conditioner starts heating, provided that the room temperature is lower than the selected temperature ; the fan will, however, operate.

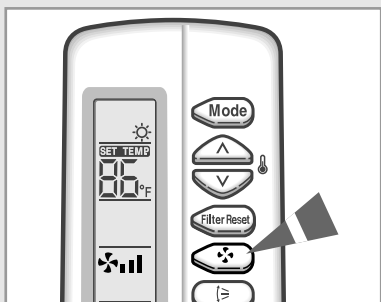

- 4 Select the fan speed by pressing the Fan button one or more times until the intended value is displayed :

- Automatic (rotated :)
- Low
- Medium
- High

- 5 To control the direction of the air flow, refer to page 17.

Removing Excess Humidity

If the atmosphere in your room is very humid or damp, you can remove excess humidity without lowering the room temperature too much.

- 1 If necessary, press (ON/OFF) button.

Result:

- ◆ The On/Off indicator on the indoor unit comes on.
- ◆ The air conditioner runs in the mode selected when the unit was last used.
- ◆ The indoor unit beeps.

IMPORTANT The air conditioner is fitted with a protection mechanism to prevent the unit from being damaged when it is started immediately after being:

- ◆ Plugged in
- ◆ Stopped

It will start up normally after three minutes.

- 2 To select the DRY mode, press the Mode button until is displayed at the top of the wireless remote controller.

Result:

- ◆ The indoor unit beeps.
- ◆ The air conditioner runs in DRY mode.

Note You can change modes at any time.

- 3 To adjust the temperature, press the Temperature buttons one or more times until the required temperature is displayed. Possible temperatures are between 65°F and 86°F inclusive.

Result:

- ◆ Each time you press Temperature buttons:
 - The temperature is adjusted by 1°F.
 - The indoor unit beeps.
- ◆ The air conditioner starts removing the excess humidity. The quantity of air is adjusted automatically.

Note In the dry mode, the fan speed is controlled automatically.

- 4 To control the direction of the air flow, refer to page 17.

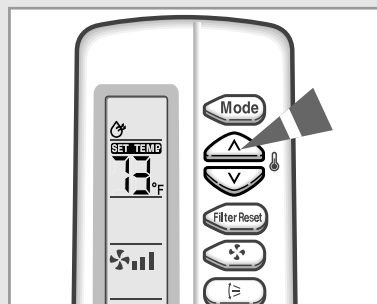
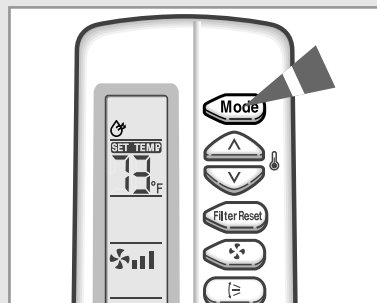
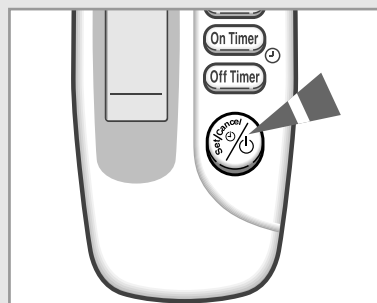

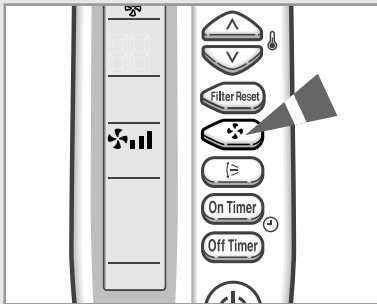
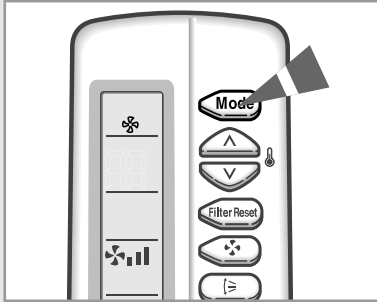

If the atmosphere in your room is stale, you can air it using the FAN feature.

- 1 If necessary, press  (ON/OFF) button.

Result:

- ◆ The On/Off indicator on the indoor unit comes on.
- ◆ The air conditioner runs in the mode selected when the unit was last used.
- ◆ The indoor unit beeps.



- 2 To select the FAN mode, press the Mode button until  is displayed at the top of the wireless remote controller.

Result:

- ◆ The indoor unit beeps.
- ◆ The air conditioner runs in FAN mode.

Note You can change modes at any time.

- 3 Select the fan speed by pressing the Fan button one or more times until the intended value is displayed:

	Low
	Medium
	High

- 4 To control the direction of the air flow, refer to page 17.

Adjusting the Air Flow Direction

Depending on the position of the indoor unit, you can adjust the position of the air flow blades, thus increasing the efficiency of the air conditioner.

1 Press the Swing button.

Result: ◆ The blades are moving between up and down.
◆ The indoor unit beeps.

IMPORTANT When the air conditioner is first turned on, the blades are moved.

2 To stop the blades, press the Swing button again.

To set to the required position, press the Swing button again when the blades are in the required position.

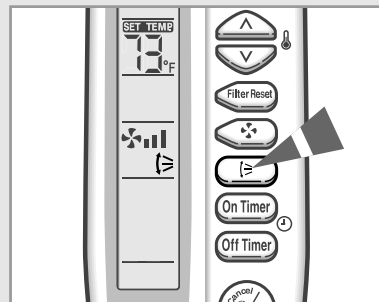

Setting the On Timer

The On Timer enables you to switch on the air conditioner automatically after a given period of time. You can set the period of time from 30 minutes to 24 hours.

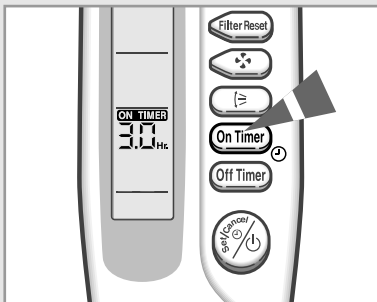

- 1 To set the operating time, press the On Timer button one or more times until the required time is displayed. Possible time is between 0.5 hour and 24 hour inclusive.

Result: ◆ Each time you press On Timer button:
- The time is adjusted by 0.5 hour to 5 hours, by 1 hour from 6 hours to 24 hours.

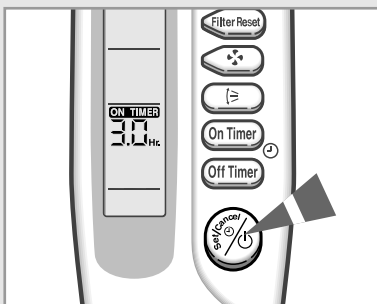

- 2 Press the  (Set/Cancel) button to complete the setting.

Result: ◆ The remaining time is displayed.
◆ Blinking of the timer indicator stops.
◆ The selected mode and the temperature disappear on the display after 5 seconds.
◆ The air conditioner will switch on automatically when the counter displayed on the remote controller reaches the setting time as disappearing the On timer setting.

Note You can see or change the setting mode and/or the temperature by pressing the Mode button or the Temperature buttons after setting the On timer.

To Cancel the On Timer

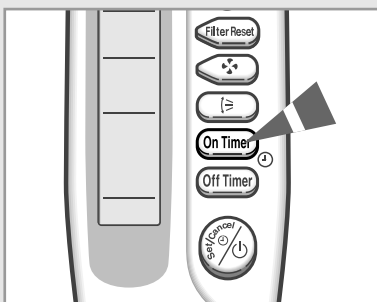

- 1 To cancel the On Timer, press the On Timer button one or more times until the timer setting disappears.

- 2 Press the  (Set/Cancel) button.

Note If you want to turn on the air conditioner before the timer reaches the setting time, press the  (ON/OFF) button.

Setting the Off Timer

The Off Timer enables you to switch off the air conditioner automatically after a given period of time. You can set the period of time from 30 minutes to 24 hours.

- 1 To set the operating time, press the Off Timer button one or more times until the required time is displayed. Possible time is between 0.5 hour and 24 hour inclusive.

Result: ◆ Each time you press Off Timer button:
- The time is adjusted by 0.5 hour to 5 hours, by 1 hour from 6 hours to 24 hours.

- 2 Press the (Set/Cancel) button to complete the setting.

Result: ◆ The remaining time is displayed.
◆ Blinking of the timer indicator stops.
◆ The selected mode and the temperature disappear on the display after 5 seconds.
◆ The air conditioner will switch off automatically when the counter displayed on the remote controller reaches the setting time as disappearing the Off timer setting.

Example If you would like to turn the air conditioner on after 2 hours and to operate it for 2 hours:

1. Press the On Timer button until '2.0 Hr' is displayed.
2. Press the (Set/Cancel) button.
3. Press the Off Timer button until '4.0 Hr' is displayed.
4. Press the (Set/Cancel) button.

Note You can see or change the setting mode and/or the temperature by pressing the Mode button or the Temperature buttons after setting the Off timer.

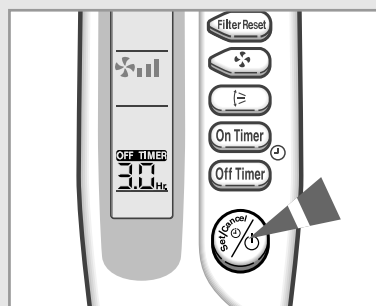
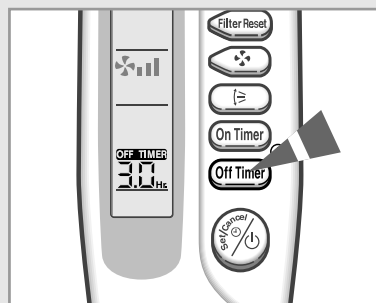

To Cancel the Off Timer

- 1 To cancel the Off Timer, press the Off Timer button one or more times until the timer setting disappears.

- 2 Press the (Set/Cancel) button.

Note If you want to turn off the air conditioner before the timer reaches the setting time, press the (ON/OFF) button.

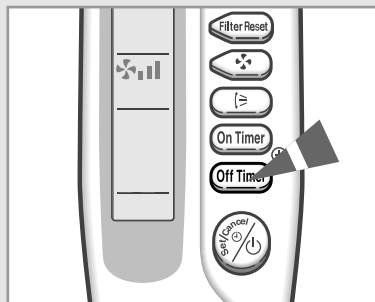

Using Wired Remote Controller

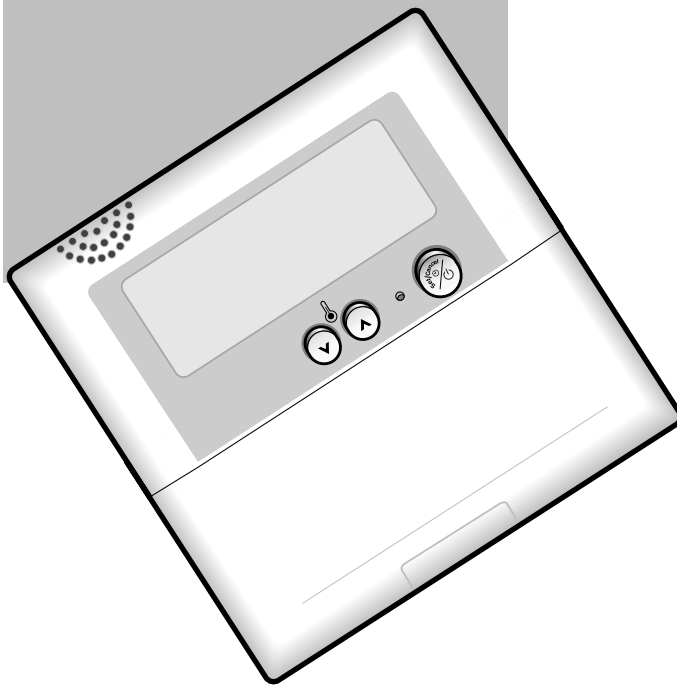

This chapter indicates how to operate and program your air conditioner with the wired remote controller. The wired remote controller is an optional accessory.

Selecting the Automatic Operating Mode

In the Automatic mode, the room temperature and the fan speed are controlled automatically.

1 If necessary, press (ON/OFF) button.

- Result:**
- ◆ The On/Off indicator on the wired remote controller comes on.
 - ◆ The air conditioner runs in the mode selected when the unit was last used.

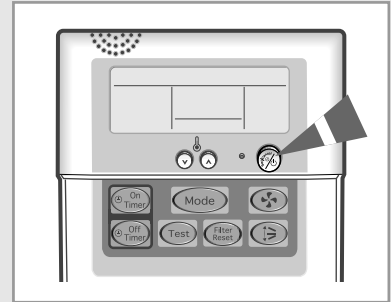

IMPORTANT The air conditioner is fitted with a protection mechanism to prevent the unit from being damaged when it is started immediately after being:

- ◆ Plugged in
 - ◆ Stopped
- It will start up normally after three minutes.

2 To select the AUTO mode, press the Mode button until is displayed at the top of the wired remote controller.

- Result:**
- ◆ The air conditioner runs in AUTO mode.

Note You can change modes at any time.

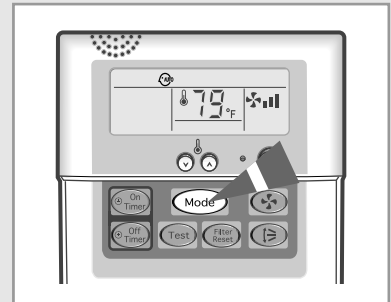

3 To adjust the temperature, press the Temperature buttons one or more times until the required temperature is displayed. Possible temperatures are between 65°F and 86°F inclusive.

- Result:**
- ◆ Each time you press Temperature buttons:
 - The temperature is adjusted by 1°F.
 - ◆ The air conditioner starts cooling, provided that the room temperature is higher than the selected temperature. The quantity of air is adjusted automatically.

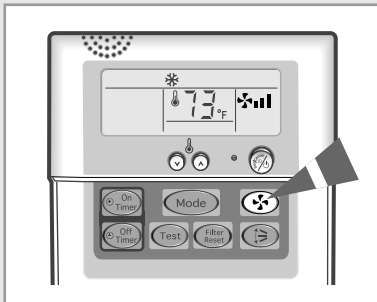
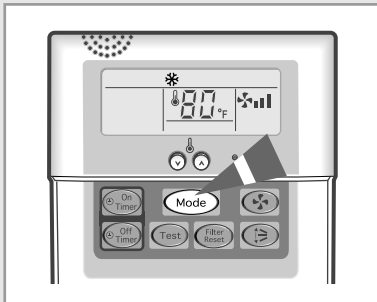
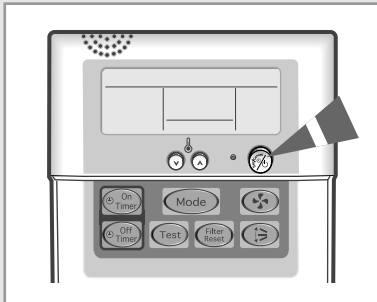

You must select the COOL mode if you wish to adjust the :

- ◆ Cooling temperature
- ◆ Fan speed when cooling

1 If necessary, press (ON/OFF) button.

- Result:
- ◆ The On/Off indicator on the wired remote controller comes on.
 - ◆ The air conditioner runs in the mode selected when the unit was last used.

IMPORTANT The air conditioner is fitted with a protection mechanism to prevent the unit from being damaged when it is started immediately after being:

- ◆ Plugged in
- ◆ Stopped

It will start up normally after three minutes.

2 To select the COOL mode, press the Mode button until is displayed at the top of the wired remote controller.

- Result: ◆ The air conditioner runs in COOL mode.

Note You can change modes at any time.

3 To adjust the temperature, press the Temperature buttons one or more times until the required temperature is displayed. Possible temperatures are between 65°F and 86°F inclusive.

- Result:
- ◆ Each time you press Temperature buttons:
 - The temperature is adjusted by 1°F.
 - ◆ The air conditioner starts cooling, provided that the room temperature is higher than the selected temperature ; the fan will, however, operate.

4 Select the fan speed by pressing the Fan button one or more times until the intended value is displayed :

- Automatic (rotated :)
- Low
- Medium
- High

5 To control the direction of the air flow, refer to page 25.

Heating Your Room (Except Cooling Only Models)

You can select the HEAT mode only in heat pump models.

You must select the HEAT mode if you wish to adjust the :

- ◆ Heating temperature
- ◆ Fan speed when heating

1 If necessary, press (ON/OFF) button.

- Result:**
- ◆ The On/Off indicator on the wired remote controller comes on.
 - ◆ The air conditioner runs in the mode selected when the unit was last used.

IMPORTANT The air conditioner is fitted with a protection mechanism to prevent the unit from being damaged when it is started immediately after being:

- ◆ Plugged in
- ◆ Stopped

It will start up normally after three minutes.

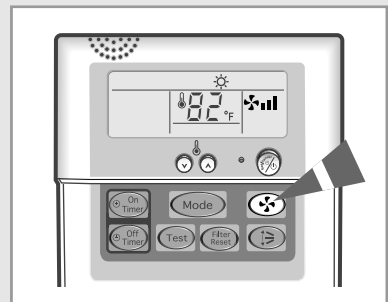
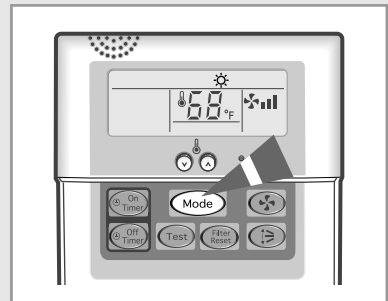
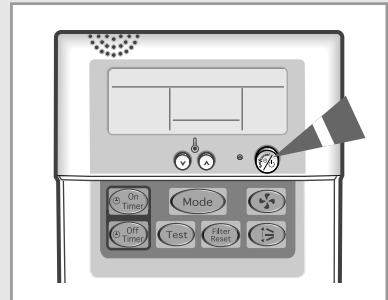

2 To select the HEAT mode, press the Mode button until is displayed at the top of the wired remote controller.

Result: ◆ The air conditioner runs in HEAT mode.

Note You can change modes at any time.

3 To adjust the temperature, press the Temperature buttons one or more times until the required temperature is displayed. Possible temperatures are between 61°F and 86°F inclusive.

- Result:**
- ◆ Each time you press Temperature buttons:
 - The temperature is adjusted by 1°F.
 - ◆ The air conditioner starts heating, provided that the room temperature is lower than the selected temperature ; the fan will, however, operate.

4 Select the fan speed by pressing the Fan button one or more times until the intended value is displayed :

- Automatic (rotated :)
- Low
- Medium
- High

5 To control the direction of the air flow, refer to page 25.

Removing Excess Humidity

If the atmosphere in your room is very humid or damp, you can remove excess humidity without lowering the room temperature too much.

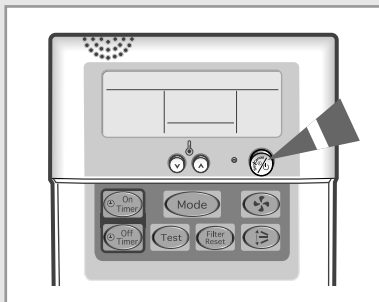

- 1 If necessary, press  (ON/OFF) button.

Result:

- ◆ The On/Off indicator on the wired remote controller comes on.
- ◆ The air conditioner runs in the mode selected when the unit was last used.

IMPORTANT The air conditioner is fitted with a protection mechanism to prevent the unit from being damaged when it is started immediately after being:

- ◆ Plugged in
- ◆ Stopped

It will start up normally after three minutes.

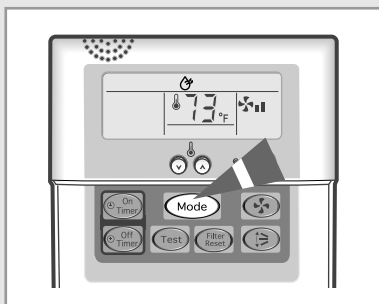

- 2 To select the DRY mode, press the Mode button until  is displayed at the top of the wired remote controller.

Result: ◆ The air conditioner runs in DRY mode.

Note You can change modes at any time.

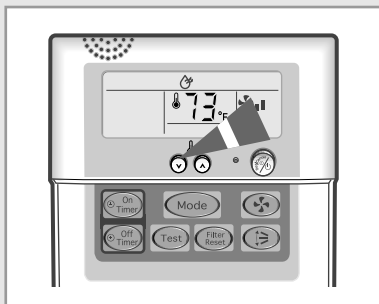

- 3 To adjust the temperature, press the Temperature buttons one or more times until the required temperature is displayed. Possible temperatures are between 65°F and 86°F inclusive.

Result:

- ◆ Each time you press Temperature buttons:
 - The temperature is adjusted by 1°F.
- ◆ The air conditioner starts removing the excess humidity. The quantity of air is adjusted automatically.

Note In the dry mode, the fan speed is controlled automatically.

- 4 To control the direction of the air flow, refer to page 25.



Airing Your Room

If the atmosphere in your room is stale, you can air it using the FAN feature.

1 If necessary, press (ON/OFF) button.
Result: ♦ The On/Off indicator on the wired remote controller comes on.
 ♦ The air conditioner runs in the mode selected when the unit was last used.

2 To select the FAN mode, press the Mode button until is displayed at the top of the wired remote controller.
Result: ♦ The air conditioner runs in FAN mode.

3 Select the fan speed by pressing the Fan button one or more times until the intended value is displayed:

	Low
	Medium
	High

4 To control the direction of the air flow, refer to below.

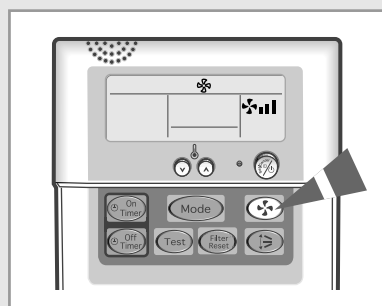
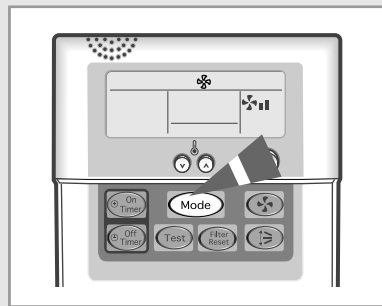

Adjusting the Air Flow Direction

Depending on the position of the indoor unit, you can adjust the position of the air flow blades, thus increasing the efficiency of the air conditioner.

1 Press the Swing button.
Result: The blades are moving between up and down.
IMPORTANT When the air conditioner is first turned on, the blades are moved.

2 To stop the blades, press the Swing button again.
 To set to the required position, press the Swing button again when the blades are in the required position.

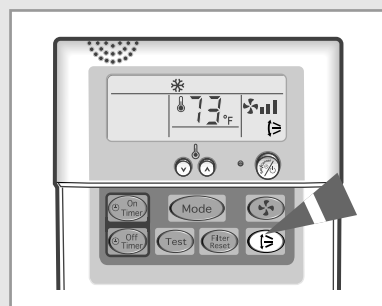

Setting the On Timer

The On Timer enables you to switch on the air conditioner automatically after a given period of time. You can set the period of time from 30 minutes to 24 hours.

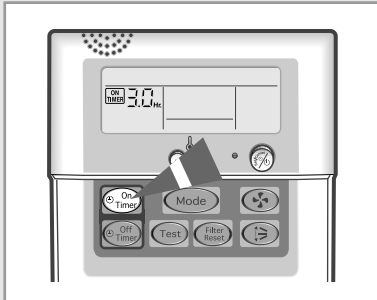

- 1 To set the operating time, press the On Timer button one or more times until the required time is displayed. Possible time is between 0.5 hour and 24 hours inclusive.

Result:

- ◆ Each time you press On Timer button:
 - The time is adjusted by 0.5 hour to 5 hours, by 1 hour from 6 hours to 24 hours.

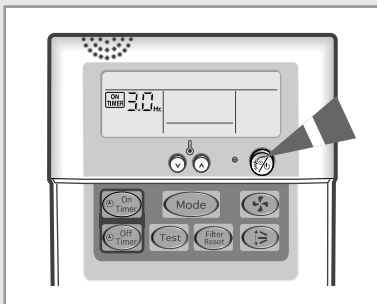

- 2 Press the  (Set/Cancel) button to complete the setting.

Result:

- ◆ The remaining time is displayed.
- ◆ Blinking of the timer indicator stops.
- ◆ The selected mode and the temperature disappear on the display after 5 seconds.
- ◆ The air conditioner will switch on automatically when the counter displayed on the remote controller reaches the setting time as disappearing the On timer setting.

Note You can see or change the setting mode and/or the temperature by pressing the Mode button or the Temperature buttons after setting the On timer.

To Cancel the On Timer

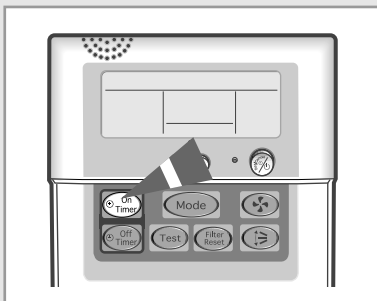

- 1 To cancel the On Timer, press the On Timer button one or more times until the On timer setting disappears.

- 2 Press the  (Set/Cancel) button.

Note If you want to turn on the air conditioner before the timer reaches the setting time, press the  (ON/OFF) button.

Setting the Off Timer

The Off Timer enables you to switch off the air conditioner automatically after a given period of time. You can set the period of time from 30 minutes to 24 hours.

- To set the operating time, press the Off Timer button one or more times until the required time is displayed. Possible time is between 0.5 hour and 24 hour inclusive.

Result:

- ◆ Each time you press Off Timer button:
 - The time is adjusted by 0.5 hour to 5 hours, by 1 hour from 6 hours to 24 hours.

- Press the (Set/Cancel) button to complete the setting.

Result:

- ◆ The remaining time is displayed.
- ◆ Blinking of the timer indicator stops.
- ◆ The selected mode and the temperature disappear on the display after 5 seconds.
- ◆ The air conditioner will switch off automatically when the counter displayed on the remote controller reaches the setting time as disappearing the Off timer setting.

Example If you would like to turn the air conditioner on after 2 hours and to operate it for 2 hours:

- Press the On Timer button until '2.0 Hr' is displayed.
- Press the (Set/Cancel) button.
- Press the Off Timer button until '4.0 Hr' is displayed.
- Press the (Set/Cancel) button.

Note You can see or change the setting mode and/or the temperature by pressing the Mode button or the Temperature buttons after setting the Off timer.

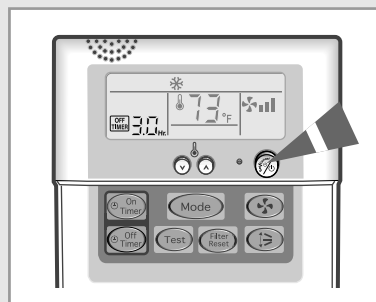
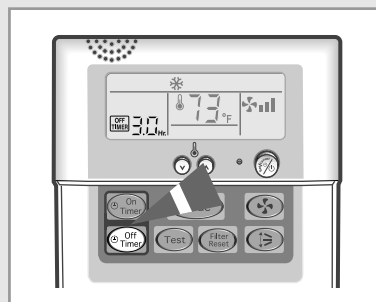

To Cancel the Off Timer

- To cancel the Off Timer, press the Off Timer button one or more times until the timer setting disappears.

- Press the (Set/Cancel) button.

Note If you want to turn off the air conditioner before the timer reaches the setting time, press the (ON/OFF) button.

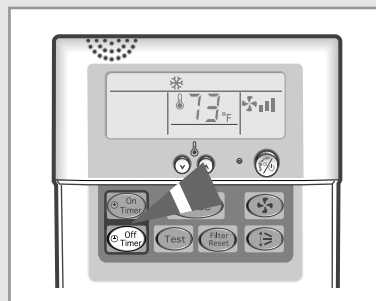

Using the Centralized Controller

The centralized controller is an optional accessory.

Up to sixteen air conditioners can be turned on or off by connecting to the centralized controller. However, you cannot adjust the cooling temperature or set the timer with it. If you also have the wired remote controller, CENTRALIZED CONTROL is displayed at the top of the remote controller.

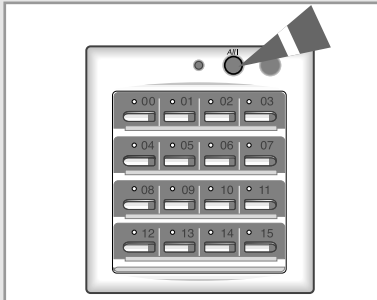

- 1 To turn on the all of air conditioners connected to the centralized controller, press the  (All ON) button.

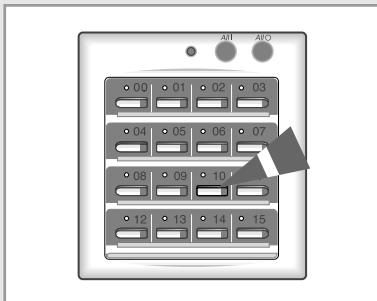

- 2 To turn on/off a specific air conditioner, press the  (ON/OFF) button.
Result: ◆ The On/Off indicator comes on when the air conditioner is operating.

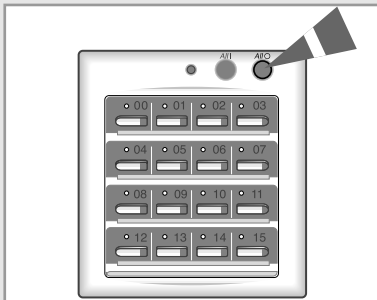

- 3 To turn off the all of air conditioners connected to the centralized controller, press the  (All OFF) button.

Operating Recommendations

Here are a few recommendations that you should follow when operating your air conditioner.

Topic	Recommendation
Heating performances	The heat pump function of the air conditioner absorbs heat from outside air and brings it indoors. As the temperature of the outside air drops, the heating performance of air conditioner will decrease. If you find that the room is not warm enough, using an additional heating appliance is recommended.
Frost	<p>When outside temperature is low but humidity is high, frost may form on the outdoor unit at HEAT mode.</p> <p>If this happens:</p> <ul style="list-style-type: none"> ◆ The heating operation stops. ◆ The defrost mode will be triggered automatically for about ten minutes. <p>No intervention is required ; after about ten minutes, the air conditioner operates again normally.</p>
High indoor and outdoor temperatures	<p>If both indoor and outdoor temperatures are high and the air conditioner is running at HEAT mode, the outdoor unit's fan and compressor may stop at times.</p> <p>This is normal ; simply wait until the air conditioner switches on again.</p>
Power failure	If a power failure occurs while the air conditioner is operating, the unit will be switched off. When the power returns, the air conditioner starts up again automatically.

Temperature and Humidity Ranges

The following table indicates the temperature and humidity ranges, within which the air conditioner can be used.

If the air conditioner is used at...	Then...
High temperature	The automatic protection feature may be triggered and the air conditioner stopped.
Low temperature	A water leakage or some other malfunction may happen if the heat exchanger freezes.
High humidity levels	Water may condense on and drip from the surface of the indoor unit if it is used for a long periods.

Mode	Outdoor Temperature	Indoor Temperature	Indoor Humidity
Heating	- 4°F to 75°F approx.	81°F or less	-
Cooling	23°F to 109°F approx.	70°F to 90°F approx.	80% or less
Drying	23°F to 109°F approx.	65°F to 90°F approx.	-

※ ***If the heating operation is used at below 32°F(outdoor temperature) then, it does not heat at its full capacity.
If the cooling operation is used at over 91°F(indoor temperature) then, it does not cool at its full capacity.***

Cleaning Your Air Conditioner

To get the best possible use out of your air conditioner, you must clean it regularly to remove the dust that accumulates on the air filter.

IMPORTANT Before cleaning your air conditioner, ensure that you have switched off the electric circuit breaker used for the unit.

1 Open the front grille by pushing the tabs on the grille.

IMPORTANT You must give attention when disassembling the front grille and must check the safety clips have been installed. If you do not check them, the front grille will drop suddenly and you will be hurt.

2 Remove the front grille.

2-1 Remove the safety clips.

2-2 Open the front grille about 45° and pull it forward.

3 Pull out the air filter.

4 Remove all dust on air filter with a vacuum cleaner or a brush. In case of serious dust accumulation, put the air filter in warm detergent water and shake it vertically.

Note When you have installed the Bio-Pure filter, do not allow any liquids to contact the filter. It may lose its properties.

5 Dry the air filter.

6 When you have finished, insert the filter into the front grille.

7 Clean the unit with a vacuum cleaner or a brush once a month.

8 Reinstall the front grille and the safety clips.

Note You can use all 4 points of the indoor unit for installing the front grille and the safety clips depending on your requirement.

Note After cleaning the air conditioner, press the Filter Reset button.

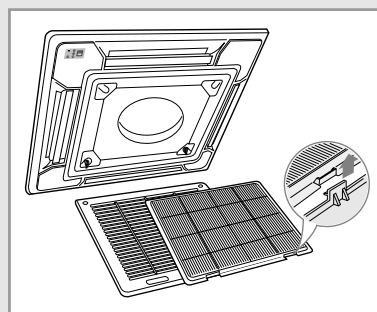
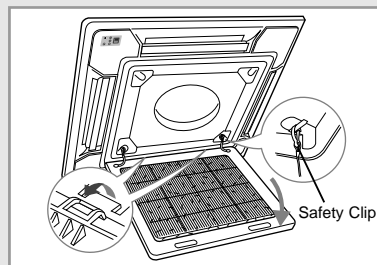
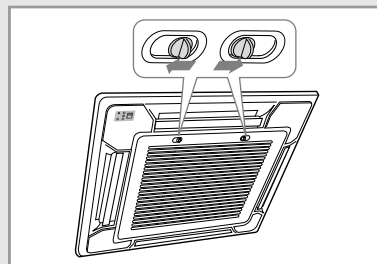

Wired Remote Controller

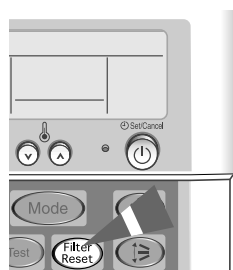

Wireless Remote Controller

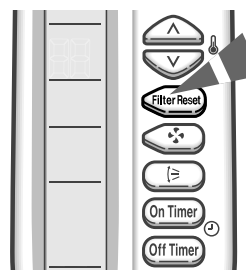

Bio-Pure Filter Installation (Optional)

The air conditioner can be fitted with a Bio-Pure filter to remove minute dust particles. The service life of the filter is approximately three months depending on the time during which the air conditioner is used.

- 1 Remove the vinyl packing from the filter.

Note Do not remove the packing from a bio-pure filter until you wish to use the filter, as it will lose its properties.

- 2 Open the front grille by pulling the tabs on the grille.

- 3 Remove the front grille.

3-1 Remove the safety clips.

3-2 Open the front grille about 45° and pull it forward.

- 4 Pull out the air filter.

- 5 Locate the bio-pure filter on the center of air filter.

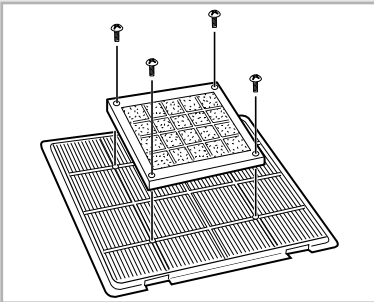

- 6 Secure the bio-pure filter with four screws.

- 7 Reinstall the air filter, the front grille and the safety clips.



Solving Common Problems

Before contacting the after-sales service, perform the following simple checks. They may save your time and expense of an unnecessary call.

Problem	Explanation/Solution
The air conditioner does not operate at all	<ul style="list-style-type: none"> ◆ Check that the breaker used for the air conditioner is switched on.
Wired Remote Controller	
The air conditioner does not operate with the remote controller	<ul style="list-style-type: none"> ◆  is displayed on the wired remote controller. In this case, turn the air conditioner off and contact your dealer.
Wired Remote Controller	
When turning on/off the air conditioner, it is not turned on/off immediately.	<ul style="list-style-type: none"> ◆ In case of using the wired remote controller for a group, the air conditioners connected to the remote controller are turned on/off in order. Thus, it takes some time (up to 32 seconds).
Wireless Remote Controller	
The air conditioner does not operate with the remote controller	<ul style="list-style-type: none"> ◆ Check that there are no obstacles between you and the remote control sensor. ◆ Check the wireless remote controller batteries (Refer to page 10). ◆ Check that you are close enough to the remote control sensor. (seven metres/yards or less).
Wireless Remote Controller	
No beep is heard when you press  (ON/OFF) on the remote controller	<ul style="list-style-type: none"> ◆ Check that you are pointing the remote controller at the remote control sensor on the indoor unit. ◆ Replace the remote controller batteries if necessary. ◆ If there is a strong light around the air conditioner, a three-wavelength light, a neon sign, etc., for example, the air conditioner may not be operated with a remote controller. If this happens, use the remote controller close by the remote control sensor.
The air conditioner does not cool or heat	<ul style="list-style-type: none"> ◆ Check that the correct operating mode has been selected. ◆ The room temperature may be too low or too high. ◆ Dust may be blocking the air filter guard; refer to page 31 for cleaning instructions. ◆ Check that there is no obstacle in front of the outdoor unit.
When heating, the required room temperature is never reached and the air conditioner frequently stops	<ul style="list-style-type: none"> ◆ Check that the required temperature has been set correctly. ◆ Increase the fan speed.

Technical Specifications

Model	Power Supply
AFPCC052CA0	1Ø, 208-230V~, 60Hz

**THIS AIR CONDITIONER IS MANUFACTURED BY:
ESTE AIRE ACONDICIONADO HA SIDO FABRICADO POR:
CE CLIMATISEUR EST FABRIQUE PAR:**



Free Manuals Download Website

<http://myh66.com>

<http://usermanuals.us>

<http://www.somanuals.com>

<http://www.4manuals.cc>

<http://www.manual-lib.com>

<http://www.404manual.com>

<http://www.luxmanual.com>

<http://aubethermostatmanual.com>

Golf course search by state

<http://golfingnear.com>

Email search by domain

<http://emailbydomain.com>

Auto manuals search

<http://auto.somanuals.com>

TV manuals search

<http://tv.somanuals.com>