



**OWNER'S INSTRUCTIONS &
INSTALLATION MANUAL**
**MANUAL DE INSTRUCCIONES &
MANUAL DE INSTALACIÓN**
**MANUEL D'UTILISATION &
MANUEL D'INSTALLATION**

**Indoor Unit
APC3240C**

**Outdoor Unit
UPC3240C**

ENGLISH

ESPAÑOL

FRANÇAIS

SPLIT - TYPE PACKAGED AIR CONDITIONER (Cool)
GRIETA DE COLMADO DE AIRE ACONDICIONADO (Refrigeración)
CLIMATISEUR MONOBLOC DE TYPE SPLIT (Refroidissement)

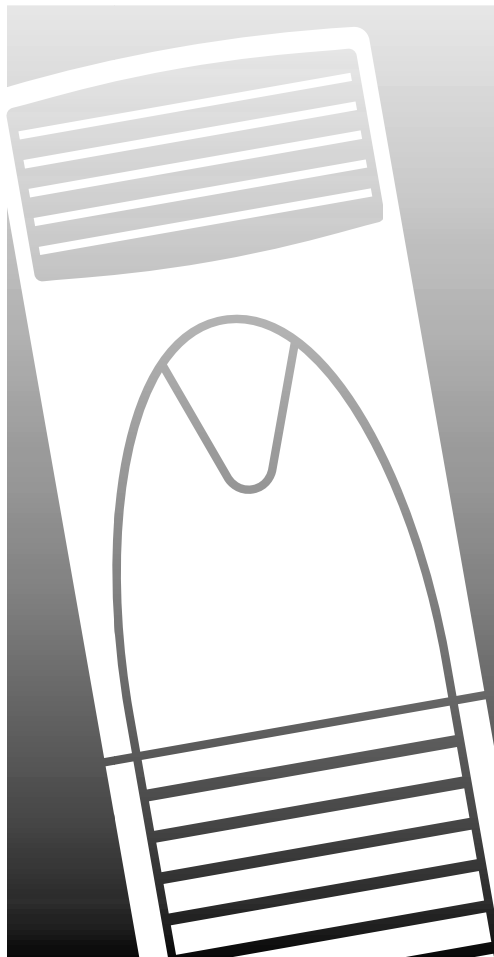

Safety Precautions

The following safety precautions must be taken when using your air conditioner.

- 1 *Make sure that the indoor unit is correctly ventilated at all times; do NOT place clothing or other materials over it.*
- 2 *NEVER spill liquid of any kind into the indoor unit. Should this happen, switch off the breaker used for your air conditioner and contact your installation specialist.*
- 3 *Do NOT insert anything between the air flow blades, as the inner fan may become damaged and you may be hurt. Keep children away from the indoor unit.*
- 4 *Do NOT place any obstacles in front of the outdoor unit.*
- 5 *If the remote control will not be used for a long time, remove the batteries.*
- 6 *Users of this product are cautioned not to attempt repair of this product at their own discretion. Instead, they are requested to directly contact a designated service center or the outlet at which the product was purchased.*
- 7 *If the supply cord is damaged, it must be replaced by a special cord or assembly available from the manufacturer or its service centre.*
- 8 *This device must be installed according to the national electrical rules.*
- 9 *Before disposing of the remote control it is necessary to remove batteries.*
- 10 *The appliance is not intended for use by young children or infirm person without supervision; young children should be supervised to ensure that they do not play with the appliance.*

CAUTION

The manufacturer does not take any responsibility for any accidents that occur because the air conditioner is not fixed firmly or installed securely, during installing or using the product. In case you experience difficulty in installation, you must use an installation specialist. An accident will occur if the installation is not done as recommends in the installation guide.

Contents

◆	PREPARING YOUR AIR CONDITIONER	
■	Safety Precautions	2
■	View of the Unit	4
■	Remote Control-Buttons and Display	6
■	Getting Started	7
■	Inserting the Remote Control Batteries	8
■	Using the Control Panel on the Indoor Unit	8
■	Using the Remote Control	8
◆	OPERATING YOUR AIR CONDITIONER	
■	Selecting the Automatic Operating Mode	9
■	Cooling Your Room	10
■	Removing Excess Humidity	11
■	Changing the Room Temperature Quickly	12
■	Selecting the Long Function	13
■	Airing Your Room	14
■	Adjusting the Air Flow Direction Vertically	15
■	Adjusting the Air Flow Direction Horizontally	15
◆	PROGRAMMING YOUR AIR CONDITIONER	
■	Setting the On Timer	16
■	Setting the Off Timer	17
■	Setting the Sleep Timer	18
◆	RECOMMENDATIONS FOR USE	
■	Operating Recommendations	19
■	Temperature and Humidity Ranges	20
■	Cleaning Your Air Conditioner	21
■	Solving Common Problems	22
◆	TECHNICAL SPECIFICATIONS	

View of the Unit

Indoor Unit

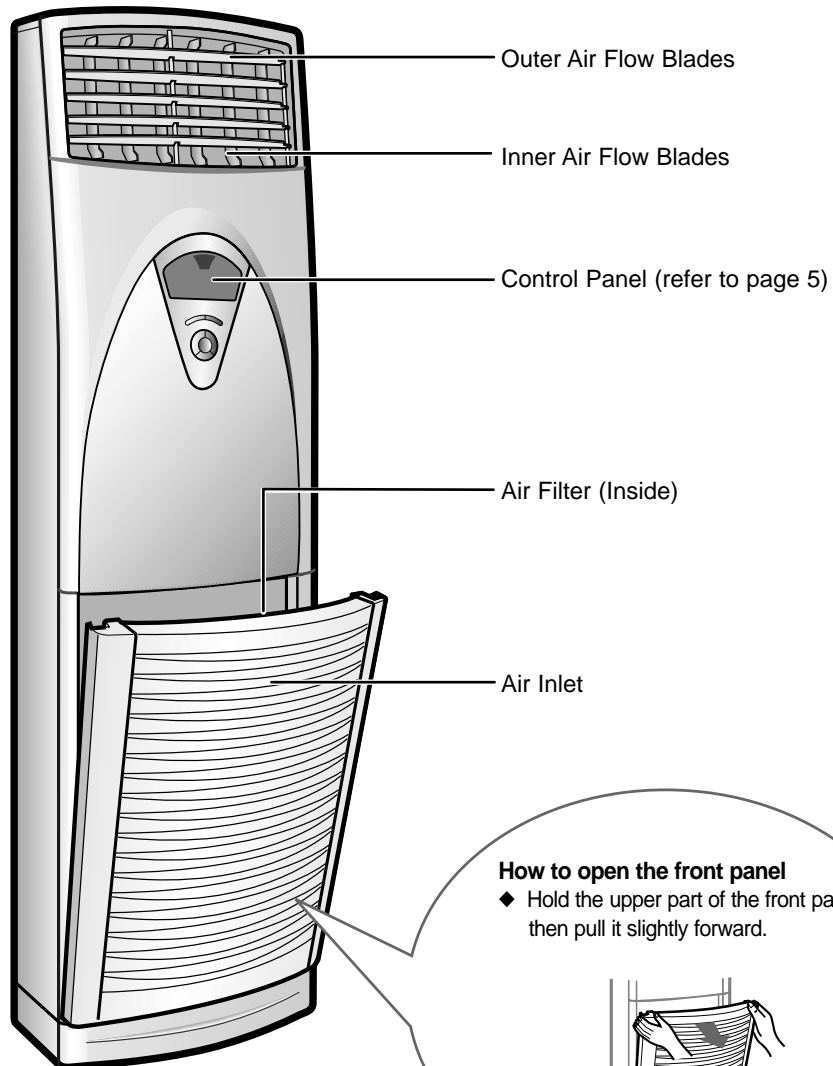

Outdoor Unit

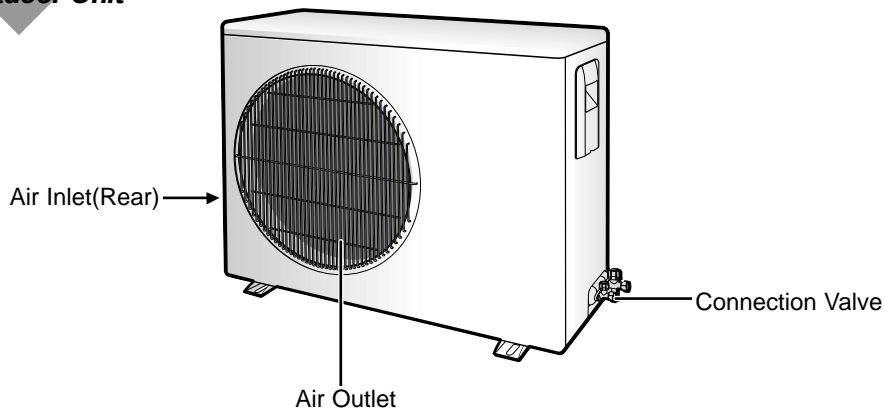

Control Panel

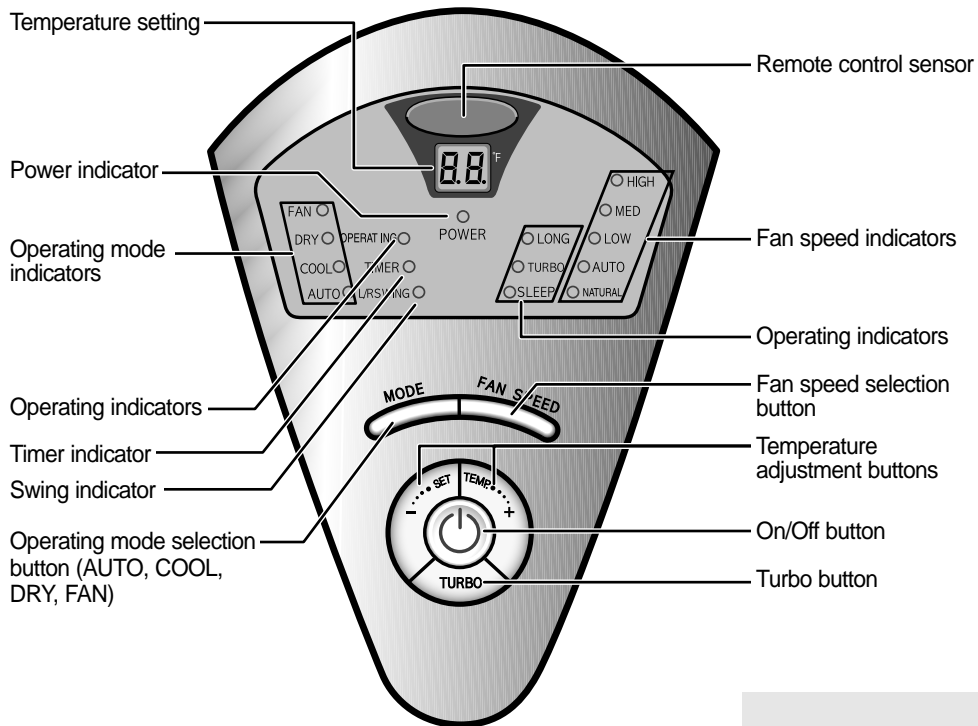

Remote Control - Buttons and Display

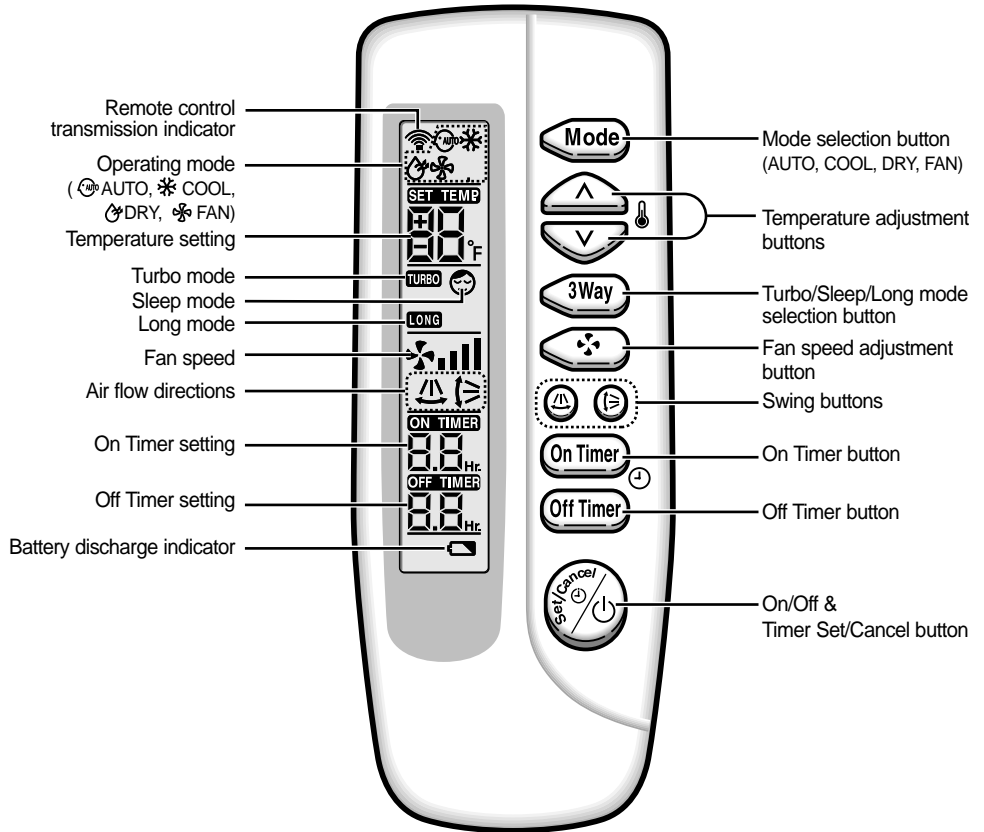

Getting Started

You have just purchased a packaged air conditioner and it has been installed by your installation specialist.

Your Owner's Instructions contains valuable information on using your air conditioner. Please take the time to read it as it will help you take full advantage of the unit's features.

The booklet is organized as follows.

- ◆ *The following figures are shown on pages from 4 to 6 :*
 - *View of the unit*
 - *Remote control(buttons and display)**They will help you find the buttons and understand the symbols displayed.*

- ◆ *In the main part of the installation book, you will find a series of step-by-step procedures for each function available.*

The illustrations in the step-by-step procedures use three different symbols:

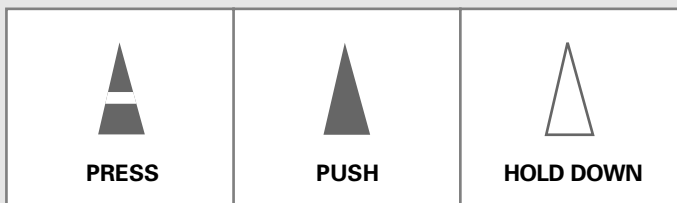

Inserting the Remote Control Batteries

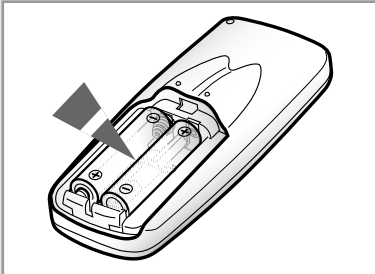
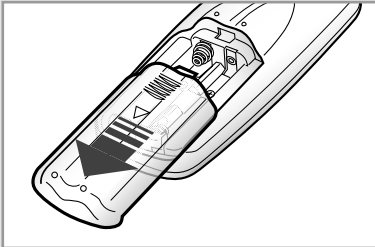

You must insert or replace the remote control batteries when :

- ◆ **You purchase the air conditioner**
- ◆ **The remote control does not work correctly**

Note

- ◆ Use two AAA, LR03 1.5V batteries.
- ◆ Do not use old batteries or different kinds of batteries together.
- ◆ Batteries may be completely discharged after 12 months, even if they have not actually been used.

- 1 Push the battery cover on the rear of the remote control with your thumb in the direction of the arrow and remove it.
- 2 Insert the two batteries, taking care to respect the polarities :
 - ◆ + on the battery with + on the remote control.
 - ◆ - on the battery with - on the remote control.
- 3 Close the cover by sliding it back until it clicks into place.

Using the Control Panel on the Indoor Unit

You can operate with indoor unit when you do not wish to or cannot operate the air conditioner with the remote control.

You can use the AUTO, COOL, DRY and FAN functions depending on your specific requirement. For further details on the functions, refer to pages 9–14.

Using the Remote Control

All features of the air conditioner can be controlled with the remote control.

Press any buttons depending on your specific requirements.

Selecting the Automatic Operating Mode

You can start the air conditioner in Automatic mode from your remote control. In the Automatic mode, the standard temperature and the optimum fan speed is selected automatically. You can adjust the standard temperature but not the fan speed.

- 1 If necessary, press the  (On/Off) button.

Result:

 - ◆ The POWER indicator on the indoor unit lights up.
 - ◆ The air conditioner starts up in the mode selected when the unit was last used.
 - ◆ The indoor unit beeps.

IMPORTANT The air conditioner is fitted with a protection mechanism to prevent the unit from being damaged when it is started immediately after being:

- ◆ Plugged in
- ◆ Stopped

It will start up normally after three minutes.

- 2 If the  is not displayed at the top of the remote control, press the MODE button on the remote control one or more times until it appears.

Result:

 - ◆ The indoor unit beeps each time you press the MODE button.
 - ◆ The air conditioner runs in AUTO mode.

Note You can change modes at any time.

- 3 To adjust the standard temperature (The air conditioner automatically set the standard temperature by the current room temperature.), press the TEMPERATURE buttons one or more times.

SET TEMP.	SET TEMP.	-	SET TEMP.	SET TEMP.
-4°F/-2°C	-2°F/-1°C	Standard temperature	+2°F/+1°C	+4°F/+2°C
< When you feel hot >			< When you feel chilly >	

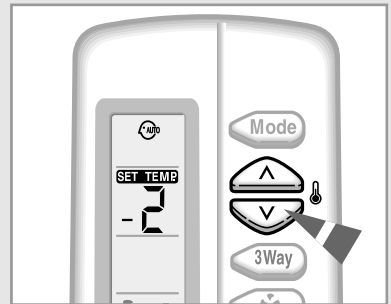
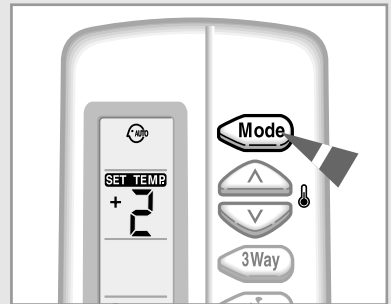
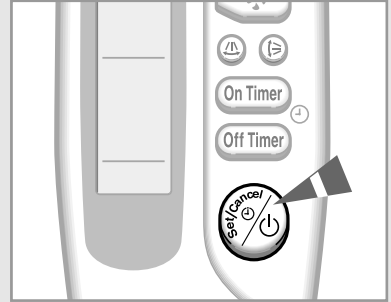

Cooling Your Room

You must select the Cool mode if you wish to adjust the:

- ◆ **Cooling temperature**
- ◆ **Fan speed when cooling**

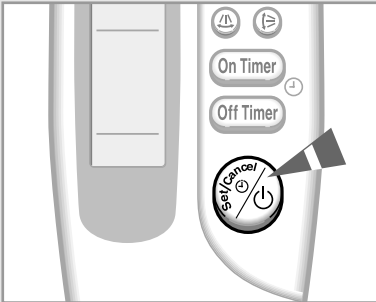



1 If necessary, press the  (On/Off) button.

- Result:
- ◆ The POWER indicator on the indoor unit lights up.
 - ◆ The air conditioner starts up in the mode selected when the unit was last used.
 - ◆ The indoor unit beeps.

IMPORTANT The air conditioner is fitted with a protection mechanism to prevent the unit from being damaged when it is started immediately after being:

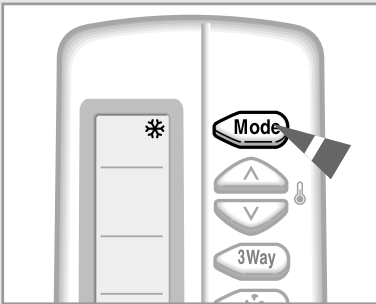
- ◆ Plugged in
 - ◆ Stopped
- It will start up normally after three minutes.



2 If the  is not displayed at the top of the remote control, press the MODE button on the remote control one or more times until it appears.

- Result:
- ◆ The indoor unit beeps each time you press the MODE button.
 - ◆ The air conditioner runs in COOL mode.

Note You can change modes at any time.

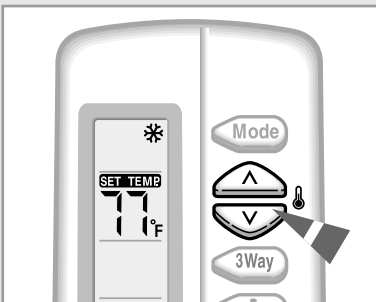



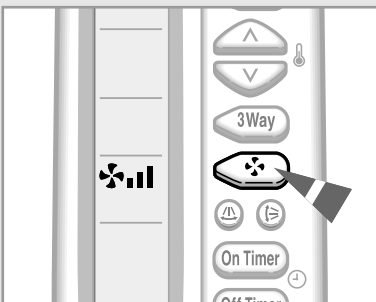

3 To adjust the temperature, press the TEMPERATURE buttons one or more times until the required temperature is displayed. Possible temperatures are between 65°F(18°C) and 86°F(30°C) inclusive.

- Result:
- ◆ Each time you press the TEMPERATURE buttons:
 - The temperature is adjusted by 1°F(1°C)
 - The indoor unit beeps
 - ◆ The air conditioner starts cooling, provided that the room temperature is higher than the selected temperature; the fan will, however, operate.

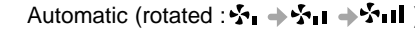

4 Select the fan speed by pressing the FAN button one or more times until the required setting is displayed:

-  Automatic (rotated : )
-  Low
-  Medium
-  High

Result: Each time you press the FAN button, the indoor unit beeps.

5 To control the direction of the air flow, refer to page 15.

Removing Excess Humidity

If the atmosphere in your room is very humid or damp, you can remove excess humidity without lowering the room temperature too much.

- 1 If necessary, press the  (On/Off) button.

Result:

- ◆ The POWER indicator on the indoor unit lights up.
- ◆ The air conditioner starts up in the mode selected when the unit was last used.
- ◆ The indoor unit beeps.

IMPORTANT The air conditioner is fitted with a protection mechanism to prevent the unit from being damaged when it is started immediately after being:

- ◆ Plugged in
- ◆ Stopped

It will start up normally after three minutes.

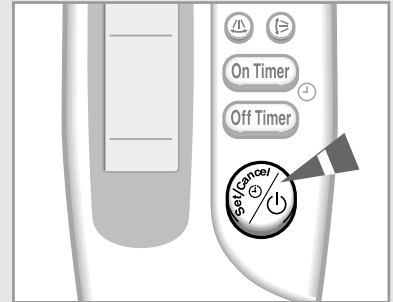

- 2 If the  is not displayed at the top of the remote control, press the MODE button on the remote control one or more times until it appears.

Result:

- ◆ The indoor unit beeps each time you press the MODE button.
- ◆ The air conditioner runs in DRY mode.

Note You can change modes at any time.

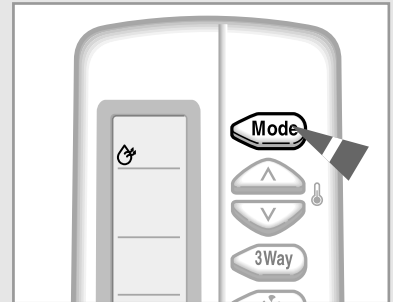

- 3 To adjust the temperature, press the TEMPERATURE buttons one or more times until the required temperature is displayed. Possible temperatures are between 65°F(18°C) and 86°F(30°C) inclusive.

Result:

- ◆ Each time you press the TEMPERATURE buttons:
 - The temperature is adjusted by 1°F(1°C)
 - The indoor unit beeps
- ◆ The air conditioner starts removing the excess humidity; the quantity of air is adjusted automatically.

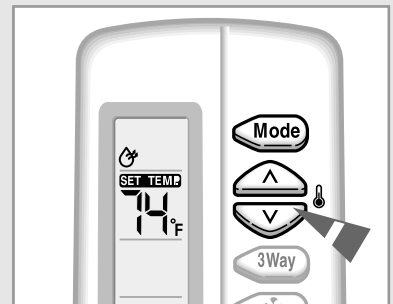

- 4 To control the direction of the air flow, refer to page 15.

Changing the Room Temperature Quickly

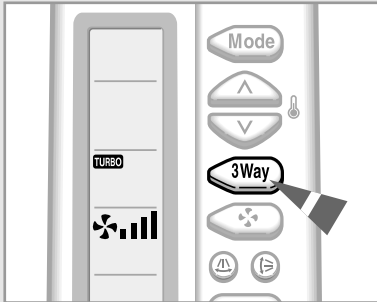

The Turbo cooling function is used to cool your room as quickly as possible.

Example : You have just come home and find that the room is very hot. You wish to cool it down as quickly as possible.

The Turbo function operates for 30 minutes with the maximum settings before returning automatically to the mode and temperature previously selected.

-
- 1 If necessary, press the  (On/Off) button.



Result:

- ◆ The POWER indicator on the indoor unit lights up.
- ◆ The air conditioner starts up in the mode selected when the unit was last used.
- ◆ The indoor unit beeps.

-
- 2 Press the  button one or more times until **TURBO** is displayed on the remote control.

Result:

- ◆ The temperature and fan settings are adjusted automatically.
- ◆ The air conditioner cools the room as quickly as possible.
- ◆ After 30 minutes, the air conditioner is reset automatically to the previous mode, temperature and fan settings.
But, if you press the  button in DRY or FAN mode, it will change to AUTO mode automatically.

-
- 3 If you wish to stop the Turbo function before the end of the 30-minute period, press the  button one or more times until **TURBO** ,  or **LONG** disappears.

Result: The air conditioner is reset automatically to the previous mode, temperature and fan settings.

-
- 4 To control the direction of the air flow, refer to page 15.
-

Selecting the Long Function

You can use the Long cooling function when you wish to make the cool air run to every corner in your room, especially when you are away from the air conditioner.

- 1 If necessary, press the  (On/Off) button.

Result:

- ◆ The POWER indicator on the indoor unit lights up.
- ◆ The air conditioner starts up in the mode selected when the unit was last used.
- ◆ The indoor unit beeps.

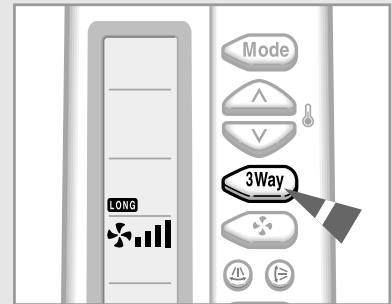



- 2 Press the  button one or more times until **LONG** is displayed on the remote control.

Result:

- ◆ The temperature and fan settings are adjusted automatically.
- ◆ The air conditioner cools the room as far as possible.

Note You cannot adjust the outer air flow blades when the Long function is selected.

- 3 If you wish to stop the Long function, press the  button one or more times until **LONG**, **TURBO** or  disappears.

Result: The air conditioner is reset automatically to the previous mode, temperature and fan settings.
But, if you press the  button in DRY or FAN mode, it will change to AUTO mode automatically.

- 4 To control the direction of the air flow, refer to page 15.

Airing Your Room

If the atmosphere in your room is stale, you can air the room using the Fan feature.

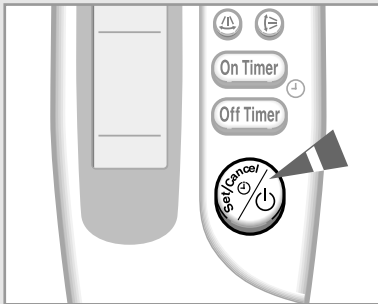

- 1 If necessary, press the  (On/Off) button.

Result:

- ◆ The POWER indicator on the indoor unit lights up.
- ◆ The air conditioner starts up in the mode selected when the unit was last used.
- ◆ The indoor unit beeps.

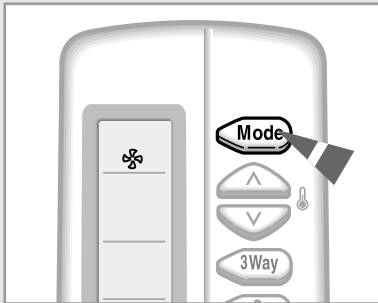

- 2 If the  is not displayed at the top of the remote control, press the MODE button on the remote control one or more times until it appears.



Result:

- ◆ The indoor unit beeps each time you press the MODE button.
- ◆ The air conditioner runs in FAN mode.
- ◆ The temperature is set automatically.

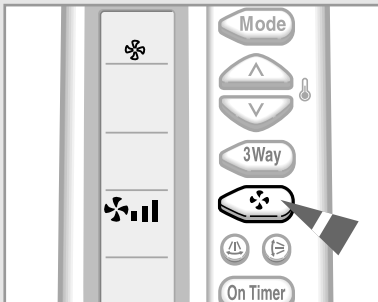
Note You can change modes at any time.



- 3 Select the fan speed by pressing the FAN button one or more times until the required setting is displayed:

 Low
 Medium
 High

Result: Each time you press the FAN button, the indoor unit beeps.

- 4 To control the direction of the air flow, refer to page 15.

Adjusting the Air Flow Direction Vertically

You can adjust the position of the outer air flow blade on the upper part of the unit, thus increasing the efficiency of the air conditioner.

- 1 Press the  button one or more times as required.

Result: The outer blade is adjusted vertically.

RECOMMENDATION	When...	Adjust the blade to face...
	Cooling	Upwards.

- 2 If you want the blade to move up and down automatically when the air conditioner is operating, press the  button.

Result: The blades move up and down, around the base position set.

- 3 To stop the blade moving up and down, press the  button again.

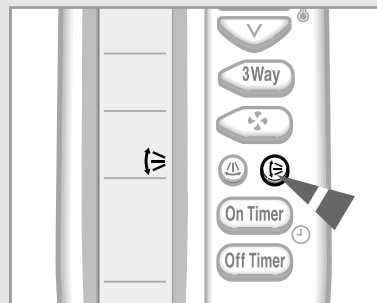

Adjusting the Air Flow Direction Horizontally

Just as the outer air flow blade can be adjusted vertically, the inner blades can be adjusted horizontally.

- 1 Press the  button one or more times as required.

Result: ♦ The inner blade is adjusted horizontally.

- 2 If you want blade to move left and right automatically when the air conditioner is operating, press the  button.

Result: ♦ The blades move left and right, around the base position set.

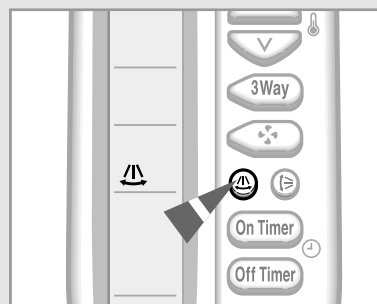

- 3 To stop the blade moving left and right, press the  button again.

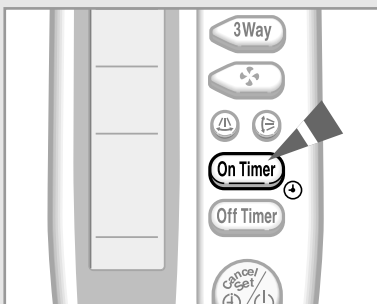
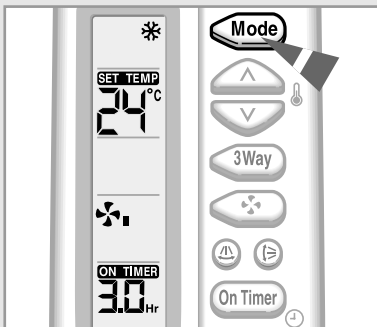
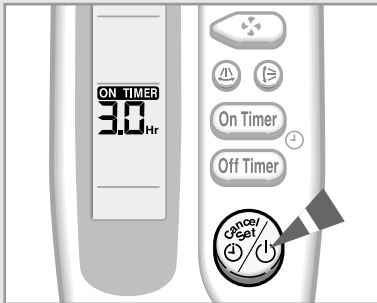
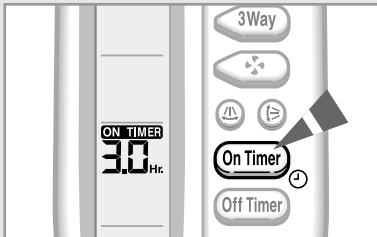

Setting the On Timer



The On Timer enables you to switch on the air conditioner automatically after a given period of time. You can set the period of time from 30 minutes to 24 hours.

- 1 To set the operating time, press the ON TIMER button one or more times until the required time is displayed. Possible time is between 0.5 hour and 24 hour inclusive.
- 2 Press the  (Set/Cancel) button to complete the setting.
Result:
 - ◆ The remaining time is displayed.
 - ◆ Blinking of the timer indicator stops.
 - ◆ The selected mode and the temperature on the display disappear after 10 seconds.
 - ◆ The air conditioner will switch on automatically when the counter displayed on the remote control reaches the set time and disappears the On timer setting.
- 3 To select an operating mode in advance, press the  button until the desired mode is displayed at the top of the remote control.
Result:
 - ◆ The air conditioner will run in the selected mode when it is turned on.

To Cancel the On Timer

- 1 To cancel the On Timer, press the ON TIMER button one or more times until the timer setting disappears.
- 2 Press the  (Set/Cancel) button.

Note If you want to turn on the air conditioner before the timer reaches the setting time, press the  (On/Off) button.

Setting the Off Timer

The Off Timer enables you to switch off the air conditioner automatically after a given period of time. You can set the period of time from 30 minutes to 24 hours.



- 1 To set the operating time, press the OFF TIMER button one or more times until the required time is displayed. Possible time is between 0.5 hour and 24 hour inclusive.

- 2 Press the  (Set/Cancel) button to complete the setting.

Result:

- ◆ The remaining time is displayed.
- ◆ Blinking of the timer indicator stops.
- ◆ The air conditioner will switch off automatically when the counter displayed on the remote control reaches the set time and disappears the Off timer setting.

Example If you would like to turn the air conditioner on after 2 hours and to operate it for 2 hours:

1. Press the ON TIMER button until '2.0 Hr' is displayed.
2. Press the  (Set/Cancel) button.
3. Press the OFF TIMER button until '4.0 Hr' is displayed.
4. Press the  (Set/Cancel) button.

Note You can see or change the setting mode and/or the temperature by pressing the MODE button or the TEMPERATURE buttons after setting the Off timer.

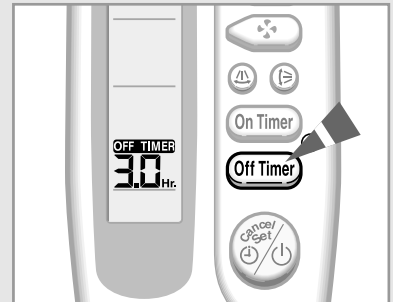

To Cancel the Off Timer

- 1 To cancel the Off Timer, press the OFF TIMER button one or more times until the timer setting disappears.

- 2 Press the  (Set/Cancel) button.

Note If you want to turn off the air conditioner before the timer reaches the setting time, press the  (On/Off) button.

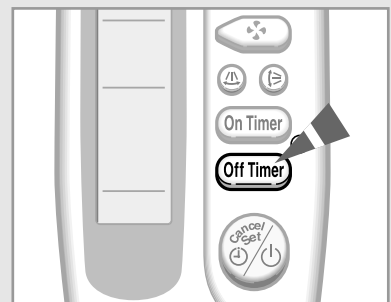

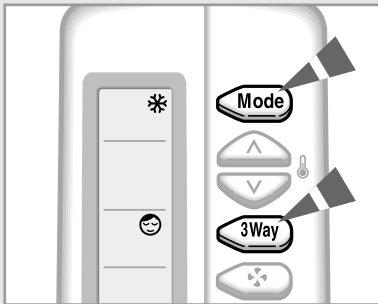

Setting the Sleep Timer



The Sleep Timer can be used when you are cooling your room to switch the air conditioner off automatically after a period of six hours.

Note If you wish to switch the unit off at a specific time, refer to page 17.

- 1 If the  is not displayed at the top of the remote control, press the MODE button on the remote control one or more times until it appears.
- 2 Press the  button one or more times until  appears on the remote control.

Result:

- ◆ The indoor unit beeps.
- ◆ The air conditioner will be controlled as indicated in the illustrations below.

Cooling The desired temperature is increased by 2°F/1°C every hour. When it has been increased by 4°F/2°C (after two hours), the temperature is maintained for four hours.

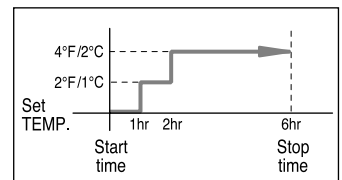

To Cancel the Sleep Timer

If you no longer wish to use the Sleep Timer that you have set, you can cancel it at any time.

Press the  button.

Result:

- ◆ The indoor unit beeps.
- ◆ The  is no longer displayed.
- ◆ The air conditioner operates normally.

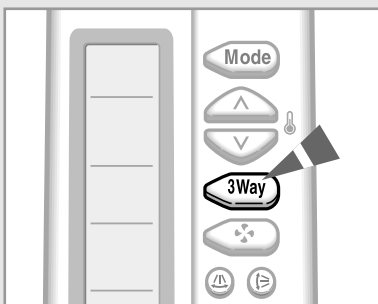

Operating Recommendations

Here is a recommendation that you should follow when using your air conditioner.

Topic	Recommendation
Power failure	If a power failure occurs when the air conditioner is operating, the unit is switched off. When the power returns, the air conditioner start up again automatically.

Temperature and Humidity Ranges

The following table indicates the temperature and humidity ranges within which the air conditioner can be used.

If the air conditioner is used at...	Then...
High temperatures	The automatic protection feature may be triggered and the air conditioner stopped.
Low temperatures	A water leak or some other malfunction may occur if the heat exchanger freezes.
High humidity levels	Water may condense on and drip from the surface of the indoor unit if it is used for long periods.

Mode	Outdoor Temperature	Indoor Temperature	Indoor Humidity
Cooling	70°F to 109°F approx. 21°C to 43°C approx.	65°F to 90°F approx. 18°C to 32°C approx.	80% or less
Drying	65°F to 109°F approx. 18°C to 43°C approx.	65°F to 90°F approx. 18°C to 32°C approx.	-

* *If the cooling operation is used at over 92°F/33°C(indoor temperature) then, it does not cool as its full capacity.*

Cleaning Your Air Conditioner

To get the best possible use out of your air conditioner, you must clean it regularly by two weeks to remove the dust that accumulates on the air filter.

IMPORTANT Before cleaning your air conditioner, ensure that you have switched off the breaker used for the unit.





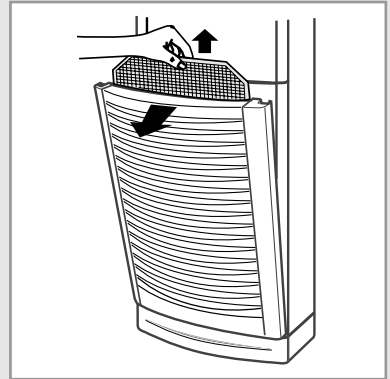

- 1 Hold the upper part of the front panel, then pull it slightly forward.
- 2 Hold the edge of the air filter under the front panel and pull to release them.
- 3 Remove all dust on the air filters with a vacuum cleaner or brush.
- 4 Clean the front panel with a damp cloth and mild detergent (do NOT use benzene, solvents or other chemicals).
- 5 Reassemble the air filter and the front panel.

Note ♦ **If you have not used the air conditioner for a long period of time, set the fan going for three to four hours to dry the inside of the air conditioner thoroughly.**



Solving Common Problems

Before contacting the after-sales service, perform the following simple checks. They may save you the time and expense of an unnecessary call.

Problem	Explanation/Solution
The air conditioner does not operate at all	<ul style="list-style-type: none"> ◆ Check that the breaker used for the air conditioner is switched on. ◆ Check that the POWER indicator on the indoor unit is on; if necessary press the  (On/Off) button on the remote control. ◆ Check whether the TIMER indicator on the indoor unit is switched on. If so: <ul style="list-style-type: none"> - Wait until the switch-on time is reached and the air conditioner starts up automatically - Cancel the timer (see pages 16~18 for further details)
The air conditioner does not operate with the remote control	<ul style="list-style-type: none"> ◆ Check that there are no obstacles between you and the indoor unit. ◆ Check the remote control batteries. ◆ Check that you are close enough to the indoor unit (seven metres/ yards/23ft or less).
No beep is heard when you press the  (On/Off) on the remote control	<ul style="list-style-type: none"> ◆ Check that you are pointing the remote control at the remote control sensor on the control panel of the indoor unit. ◆ Replace the remote control batteries if necessary.
The air conditioner does not cool	<ul style="list-style-type: none"> ◆ Check that the correct operating mode has been selected (AUTO, COOL). ◆ The room temperature may be too low or too high. ◆ Dust may be blocking the air filter guard; refer to page 21 for cleaning instructions. ◆ Check that there is no obstacle in front of the outdoor unit.
The fan speed does not change when you press the  button	<ul style="list-style-type: none"> ◆ Check that the operating mode is set to COOL or FAN ; in the AUTO, TURBO and LONG mode, the fan speed changes automatically and in the DRY mode, it is set to AUTO.
The air flow direction does not change when you press the  or  button	<ul style="list-style-type: none"> ◆ Check that the air conditioner has been switched on; if necessary, press the  (On/Off) button on the remote control.
The timer is not correctly triggered	<ul style="list-style-type: none"> ◆ Check that the timer has been programmed correctly; see pages 16~18.
Odours are permeated in the room during air conditioning	<ul style="list-style-type: none"> ◆ Air the room.

Technical Specifications

MODEL		APC3240C	
Performance Ratings	Capacity Cooling	Btu/h	30000
	SEER		10.0
	Moisture Removal	Pts/h	6.5
	Air FLOW(Cooling, HIGH)	CFM	636
	Sound Rating-Outdoor	dB	64
Electrical Data	Power source		208-230V~, 60Hz
	Min.Ampacity	A	16
	Cooling Watts	W	3250
Refrigeration Lines	Connections		Flare
	Liquid Line O. D.	mm(in)	9.52(3/8)
	Suction Line O.D.	mm(in)	15.88(5/8)
	Factory Pre-charge	m(ft)	5.0(16 $\frac{1}{2}$)
	Max. Line length	m(ft)	25(82)
	Max. Height Difference	m(ft)	15(49)
Dimensions & Weight	INDOOR UNIT		APC3240C
	W X H X D	mm(in)	500 x 1830 x 325 (19 $\frac{1}{2}$ x 72 x 13)
	Net Weight	lbs	83.6
	OUTDOOR UNIT		UPC3240C
	W X H X D	mm(in)	880 x 790 x 310 (34 $\frac{1}{2}$ x 31 $\frac{1}{8}$ x 12 $\frac{1}{4}$)
	Net Weight	lbs	162.8

* Standard rating conditions Cooling

	Indoor		Outdoor	
	DB	WB	DB	WB
°F	80	67	95	75
°C	26.7	19.4	35.0	23.9

INSTALLATION MANUAL

Contents

◆ SELECTION OF INSTALLATION PLACE	
■ Indoor Unit	26
■ Outdoor Unit	26
◆ ELECTRIC WORK	27
◆ INSTALLATION METHOD	
■ Outdoor Unit	28
■ Installation Procedures	28
■ Connection of Refrigerant Piping	30
■ Drilling a Hole in the Wall	31
■ Drain Hose	31
■ Connecting the Pipe	31
◆ AIR PURGE	32
◆ REFRIGERANT CHARGING	33
◆ CHECK AND TEST OPERATION	34

- ▶ Be sure to read the installation manual carefully to ensure sufficient realization of the excellent performance of the unit.
- ▶ Be sure to drill a hole in the wall necessary for installation before attempting to install the unit.
- ▶ After completion of installation, be sure to perform a test operation of the unit to check for any problem, and then deliver the unit to the customer if the test results are acceptable.
- ▶ After completion of test operation, hand over the owner's manual, installation manual, and warranty card to the customer.
- ※ As the installation work requires special skill, be sure to request a qualified dealer to take care of the installation of your unit; the user should not attempt to install his/her unit by himself/herself.
- ※ **Do not attach any electric heating device or electric heater to the unit.**
Do not attempt to disassemble or modify the unit by yourself.
(It may cause machine trouble, electric shock or fire.)

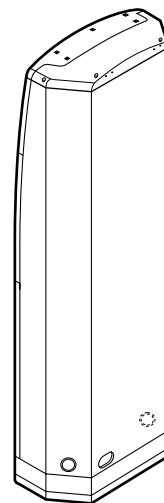

Absolute Checkpoints

1. Drain check

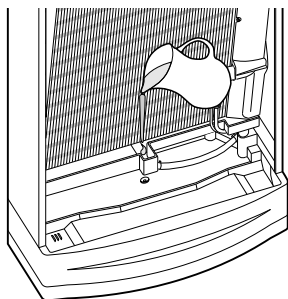

2. Drilling a hole in the wall

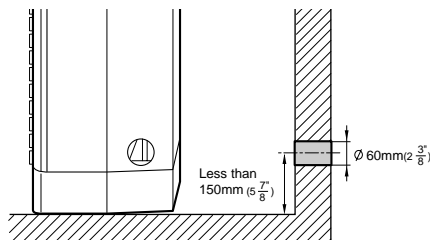

▶ Refer to page 31 for detailed procedures. ◀

SELECTION OF INSTALLATION PLACE

Indoor Unit

- ◆ Install the unit at a place close to the wall facing the outside as it is necessary to perform piping connection with the outdoor unit.
 - It is effective to install the unit at a window side to ensure uniform distribution of indoor temperature.
- ◆ Install the unit at a place where there is no obstacle against the wind around the air inlet and air outlet.
- ◆ Install the unit horizontally at a stable, rigid place. (When installing the unit at a place subjected to oscillation, noise may occur.)
- ◆ Avoid a place near the door which is frequented by people.
- ◆ Avoid a place subject to direct sunlight.

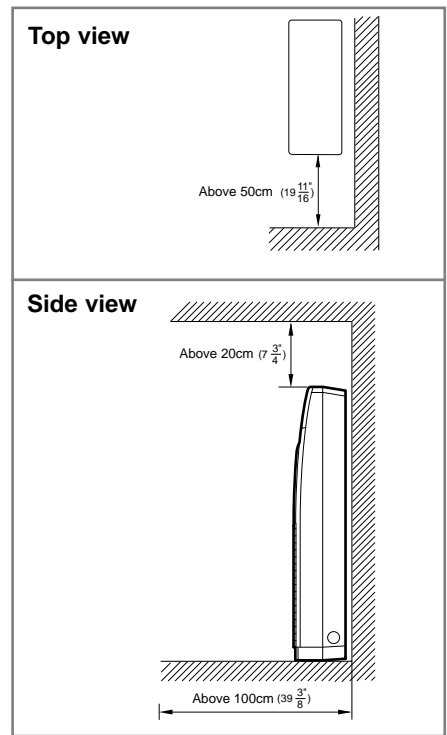

Outdoor Unit

- ◆ A place free from the risk of combustible gas leakage.
- ◆ A place which can bear the weight of the unit.
- ◆ A place which can bear the fixing strength of the outdoor unit.
- ◆ Avoid a place subject to oil (including machine oil).
- ◆ Avoid a saline place.
- ◆ Avoid a place subject to sulfide gas (hot spring zone). (When installing the unit at such special environmental conditions, it may cause machine trouble. When it is unavoidable to use such places. It requires special maintenance.)
- ◆ A place where the discharge air and noise of the outdoor unit do not disturb the neighborhood. (Take special care not to cause any inconvenience to your neighbors when installing the unit on the borderline with your neighborhood.)
- ◆ A place where strong wind does not head against the air outlet of the outdoor unit. (If a strong wind heads directly against the air outlet at the time of cool operation, a safety device can be operated.)
- ◆ Do not install the outdoor unit at an unstable place such as outer wall of an apartment or building. The outdoor unit may fall down, causing severe personal or property damage or loss.

※ If there is any unavoidable reason to install the unit at such a place, take the following measures against the wind;

1. When installing the unit at a roadside concentrated with buildings, install it parallel with the road.
2. Install the unit so that the air outlet faces toward the wall at a place such as rooftop, which may be subjected to strong wind.

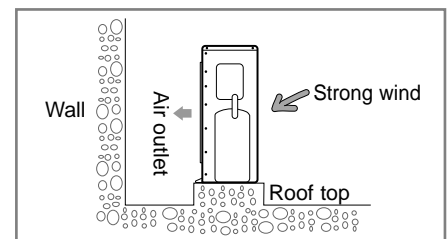

- ◆ The outdoor unit should be installed in accordance with the service space.

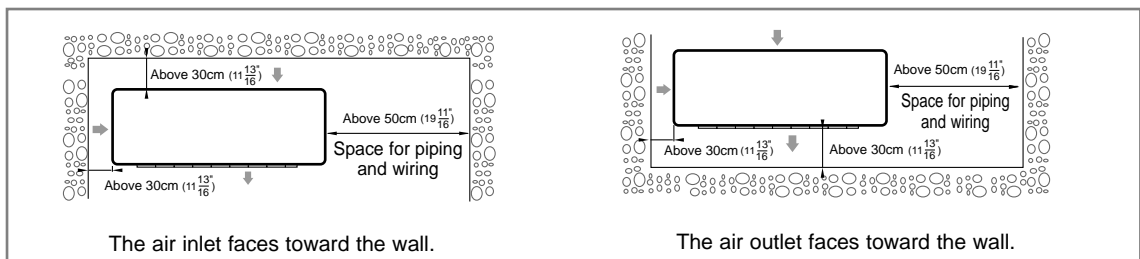

ELECTRICAL WORK

The electrical work should be performed by a specialist qualified for the work.

- ◆ Use the three phase power supply, and be sure to install the sub power distributing board for exclusive use with the unit (separately purchased by the user).
- ✱ Avoid octopus-type wiring as it can cause a drop in voltage, thus resulting in poor performance of the automatic control circuit.
- ◆ Be sure to install circuit breaker (separately purchased by the user).
- ◆ Be sure to connect the grounding wire.

Electric power spec

Power	Single phase 208-230V~, 60Hz	
Sub switch	30A	
Fuse	30A	
Electric wire	Below 20m($65\frac{5}{8}$ ft)	3.5mm ²
	Below 50m($164\frac{1}{16}$ ft)	5.5mm ²
Allowable voltage	187V~253V	

Indoor and Outdoor Connection Wiring

- ◆ When connecting the wiring harness between the indoor and outdoor unit, align the outdoor side and the indoor side with the terminal board No.
- ◆ Connect the connection wire (1, 2, 3) and power cable (L1, L2) to terminals through the conduit hole as shown in the diagram.
- ✱ When the wiring harnesses of the indoor and outdoor unit are not properly connected, it may cause trouble. Be careful not to allow the indoor and outdoor wirings and power lines to get in contact with the service valve of the refrigerant system or to the pipe without an insulator.

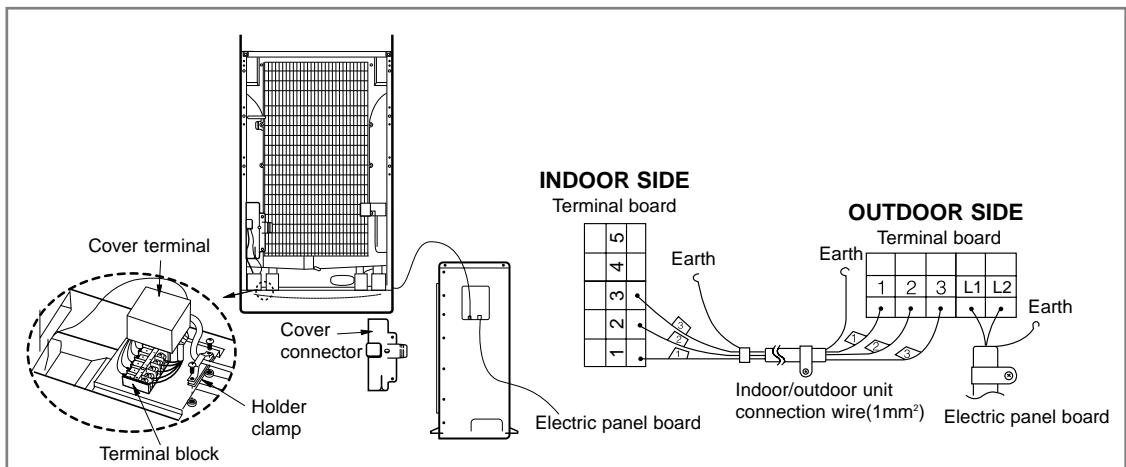

Electrical Wiring

1. Connect it to the terminal board L1 and L2 for power supply to the outdoor unit.
In so doing, peel off the end of the power cord by about 5mm($\frac{3}{16}$ "), and press the cord to the ring terminal for hooking.
2. Perform the power grounding using the screw for exclusive use with the outdoor unit.

INSTALLATION METHOD

Outdoor Unit

When using the anchor bolt

1. Fix the unit on a flat, rigid floor using the anchor bolt.
(Anchor bolt : M10 x 4 points - separately purchased)

Anchor bolt fixing dimensions

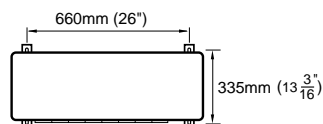

Installation Procedures

1. Open the front panel, and remove the flare nut.
 2. Bend the connection pipe to an appropriate length using the spring bender depending upon the installation place.
 - Allowable pipe length : Maximum 25m(82ft)
 - Allowable pipe drop distance : Maximum 15m(49ft)
 - Make no more than ten bending points on the pipe
- ※ When the pipe length is in excess of the standard pipe length of 5m(16 $\frac{3}{8}$ ft), add the refrigerant (R-22) of 40g for each additional 1m(3 $\frac{1}{4}$ ft).

CAUTION

- ◆ If the pipe is lengthened, the performance of the unit is degraded, and the service life is shortened. Therefore, the pipe length should be as short as possible (less than 15m(49ft)).

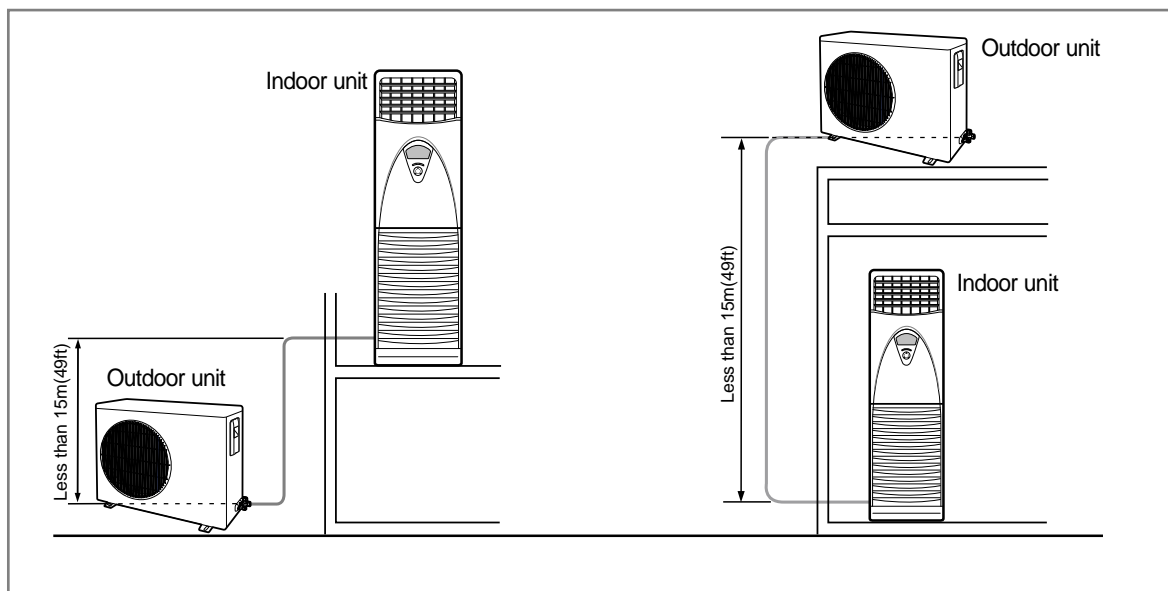

3. Install the high pressure pipe to the heat exchanger liquid pipe, and the low pressure pipe to the heat exchanger gas pipe respectively using the flare nut, taking care not to cause any leakage of refrigerant.
4. Be sure to insulate the pipe with appropriate insulation material.
5. Insert the drain hose into the drain pipe, and connect them by tying them to the cable tie to prevent any water leakage.
6. After completion of the installation, check the connecting area for any gas leakage.
7. Wind a finish tape when the wiring of the refrigerant pipe, the unit, and the drain piping are completed.

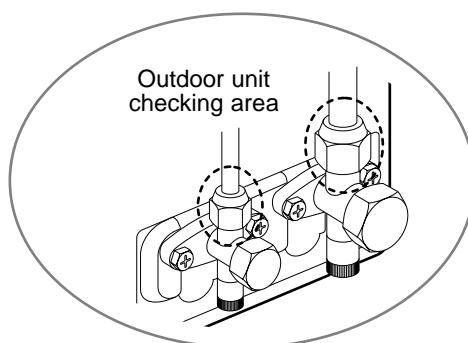
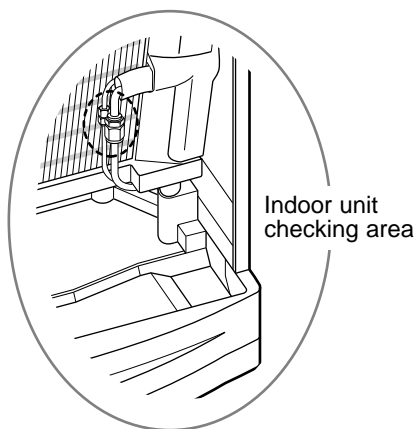

INSTALLATION METHOD

Connection of Refrigerant Piping

Flare Processing

1. Cut the pipe using the pipe cutter.

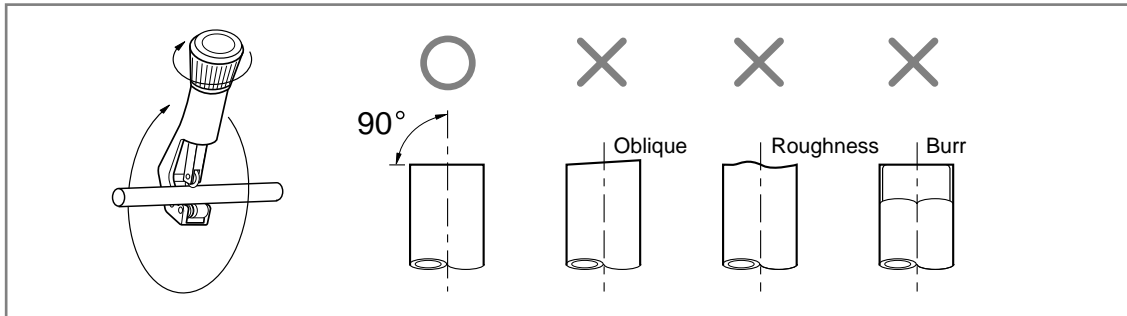

2. Insert the flare nut into the pipe, and then perform the flare processing.

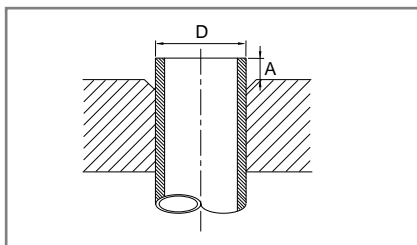

Outer Diameter(D)	A
ø 9.52mm(3/8")	1.8mm(1/16")
ø 15.88mm(5/8")	2.2mm(1/8")

Pipe Bending

1. Perform bending of the pipe using the bender which has a specified bending radius.
2. Be sure to take full care to perform bending of the pipe successfully at one time. Bending and unbending the pipe more than twice makes the bending work increasingly difficult.
3. You may use the spring inserted into the gas pipe instead of the bender to bend the pipe.
4. When you bend the pipe using the spring, hold the pipe with both hands to prevent any distortion, and secure a minimum bending radius of more than 100mm(4").

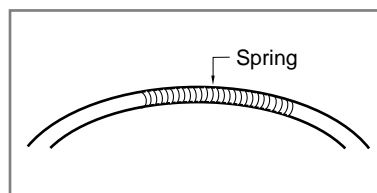

Tightening of Connection Parts

- ◆ Align the center of the connection piping, and tighten the flare nut by turning it with hand. Then tighten it again using the spanner in the direction as shown in the figure.

Outer Diameter	Tightening Torque	Final Torque	Remarks
ø 9.52mm(3/8")	400kg•cm (28.2ft•lb)	450kg•cm (31.7ft•lb)	
ø 15.88mm(5/8")	700kg•cm (50.6ft•lb)	750kg•cm (52.8ft•lb)	

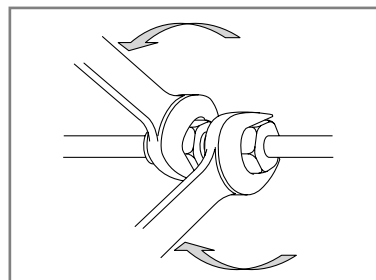

Drilling a Hole in the Wall

- ◆ Drill a hole of 60mm($2\frac{3}{8}$ ") in diameter to the outside.
- ◆ The drilling should be done at a distance of less than 150mm($5\frac{7}{8}$ ") from the floor facing the indoor unit.

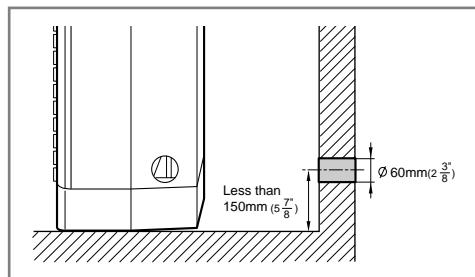

Drain Hose

- ◆ Extend the drain hose to the drain hose connected to the drain pan, and fix it with the tape or a cable tie to prevent separation. Then make a covering of it so that water cannot flow outwardly.

Piping Material	Vinyl Chloride (Inner diameter \varnothing 18mm $\frac{11}{16}$ ") Outer diameter \varnothing 23mm $\frac{7}{8}$ ")
Insulator	Foamed Polyethylene

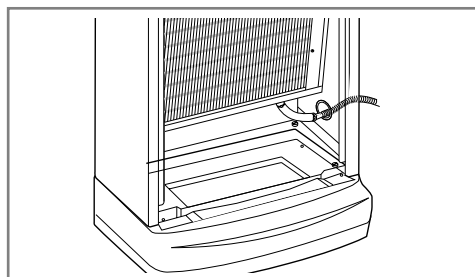

CAUTION

1. As the draining is of natural drain type, make the drain hose direct downward.
2. If there is any foreign substance in the drain plate, it may clog the drain pipe. Therefore, be sure to remove the foreign substance inside after installation.
3. After completion of installation, be sure to pour water into the drain pan, and then check the draining condition.
(There is no problem in draining when the draining is completed within 20 seconds.)

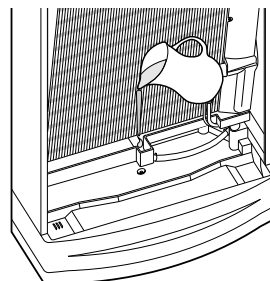

Connecting the pipe

- ◆ The piping of this unit can be connected to the right, left, or rear side. When you hit the area for piping connection slightly with a hammer, a hole is made.

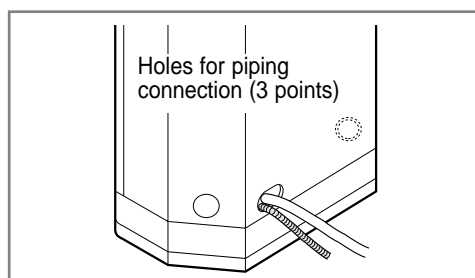

AIR PURGE

◆ The air in the indoor unit and in the pipe must be purged. If air remains in the refrigeration pipes, it will affect the compressor, reduce to cooling capacity and could lead to a malfunction.
Use Vacuum Pump as shown at the figure.

1. Connect each assembly pipe to the appropriate valve on the outdoor unit and tighten the flare nut.
2. Connect the charging hose of low pressure side of manifold gauge to the packed valve having a service port as shown at the figure.
3. Open the valve of the low pressure side of manifold gauge counter-clockwise.
4. Purge the air from the system using vacuum pump for about 10 minutes.
 - Close the valve of the low pressure side of manifold gauge clockwise.
 - Make sure that pressure gauge show $-0.1\text{MPa}(-76\text{cmHg})$ after about 10 minutes.
This procedure is very important in order to avoid gas leak.
 - Turn off the vacuum pump.
 - Remove the hose of the low pressure side of manifold gauge.
5. Set valve cork of both liquid side and gas side of packed valve to the open position.
6. Mount the valve stem nuts and the service port cap to the valve, and tighten them at the torque of $18\text{N}\cdot\text{m}$ with a torque wrench.
7. Check for gas leakage.
 - At this time, especially check for gas leakage from the 3-way valve's stem nuts, and from the service port cap.

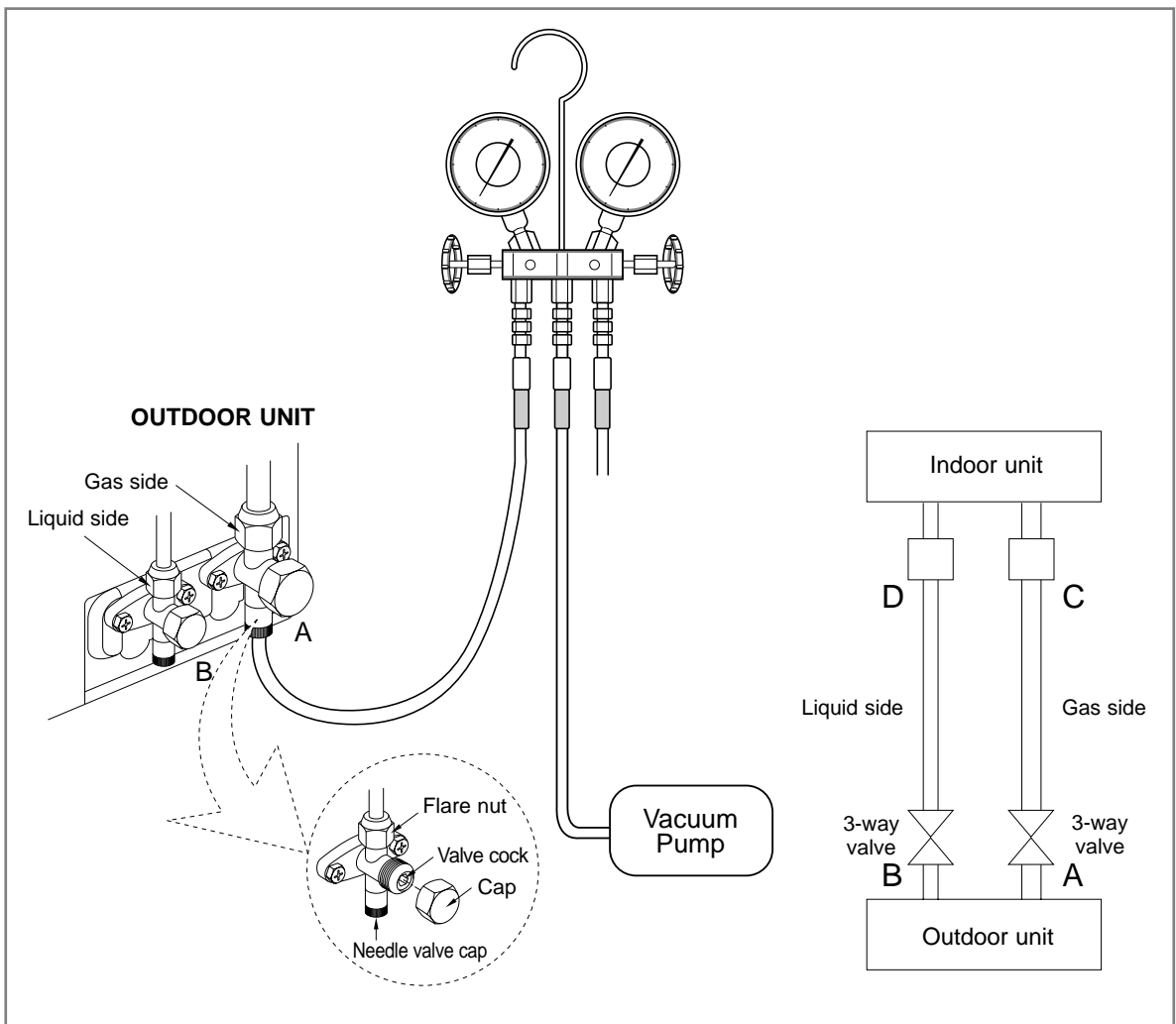

REFRIGERANT CHARGING

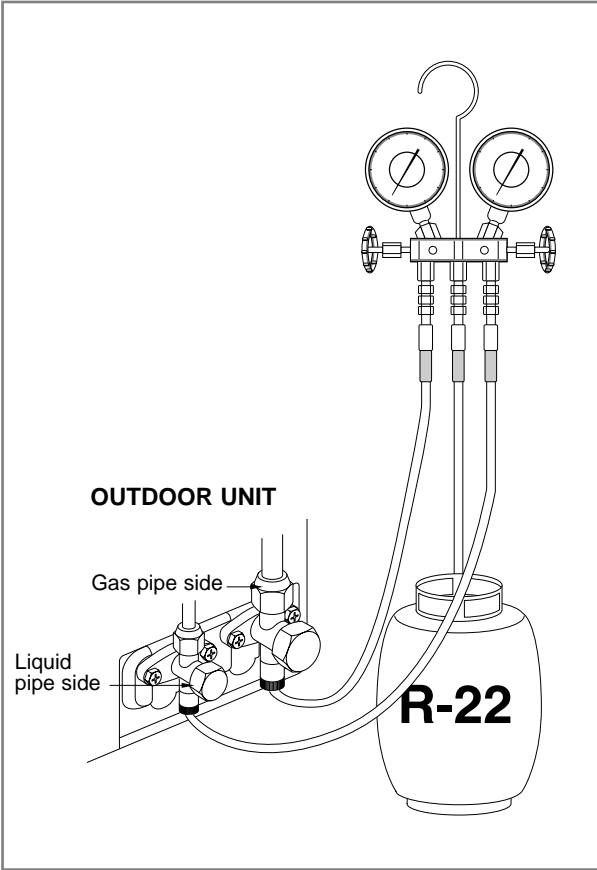
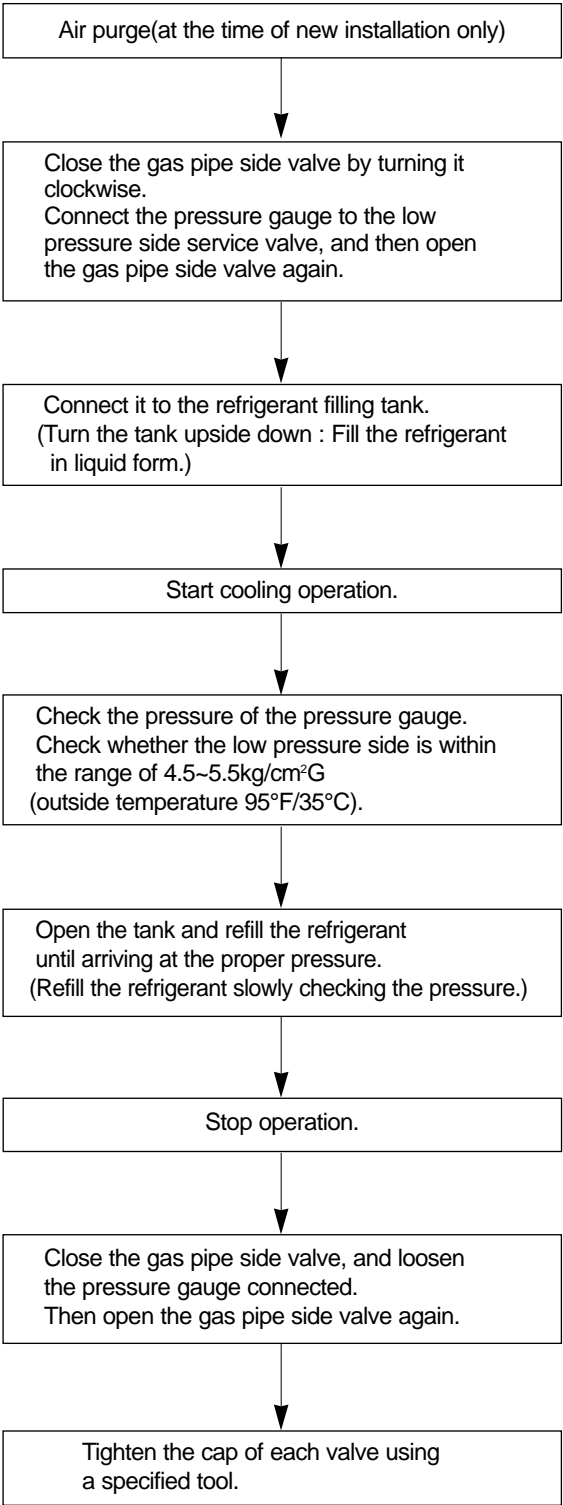

CHECK AND TEST OPERATION

Check

◆ Be sure to check the following again after completion of installation.

1. Check the piping connection area for any gas leakage.

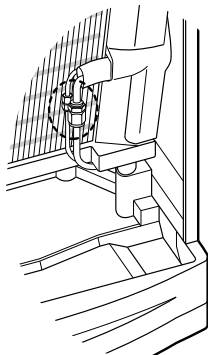

Indoor connection area

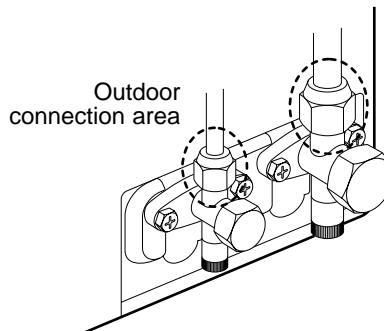

Outdoor connection area

2. Is the drain hose properly connected?

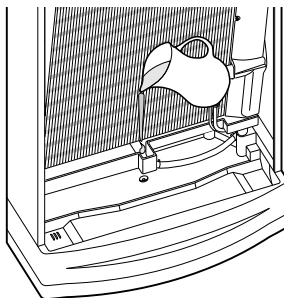

3. Is the insulation of the piping in good condition?

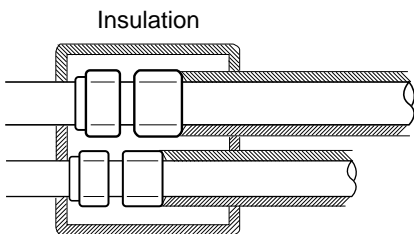

Insulation

4. Is grounding properly made?

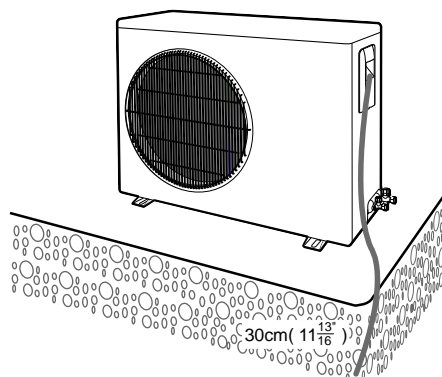

30cm (11 ¹³/₁₆)

Test Operation

- ◆ After checking, read the owner's instructions carefully, and perform a test operation. Then deliver the unit to the customer.

(When delivering the unit, be sure to read carefully and follow the contents of the owner's instructions.)

CAUTION

1. Be sure to check whether the service valve is opened before attempting to perform the test operation.
2. Never attempt to start test operation by force pressing the electronic contactor as it is very dangerous.
(This is very dangerous as the protective device does not work.)
3. Be sure to perform the test operation after installation.
It is easy to start the test operation in winter if you increase the sensor temperature to 73°F ~ 77°F/23°C ~ 25°C by holding the indoor temperature sensor. (Cooling operation)

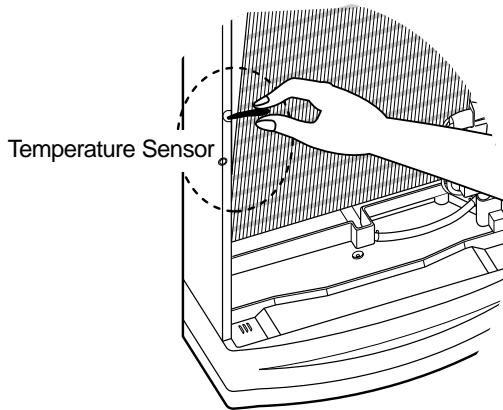

**THIS AIR CONDITIONER IS MANUFACTURED BY:
ESTE AIRE ACONDICIONADO HA SIDO FABRICADO POR:
CE CLIMATISEUR EST FABRIQUE PAR:**



Free Manuals Download Website

<http://myh66.com>

<http://usermanuals.us>

<http://www.somanuals.com>

<http://www.4manuals.cc>

<http://www.manual-lib.com>

<http://www.404manual.com>

<http://www.luxmanual.com>

<http://aubethermostatmanual.com>

Golf course search by state

<http://golfingnear.com>

Email search by domain

<http://emailbydomain.com>

Auto manuals search

<http://auto.somanuals.com>

TV manuals search

<http://tv.somanuals.com>