

**SAMSUNG**

# OWNER'S INSTRUCTIONS MANUAL DE INSTRUCCIONES MANUEL D'UTILISATION

**Heat pump**

AVMCH052CA0(1,3,4)  
AVMCH072CA0(1,3,4)  
AVMCH105CA0(1,3,4)  
AVMCH128CA0(1,3,4)  
AVMCH140CA0(1,3,4)

**Cooling only**

AVMCC052CA0(1,3,4)  
AVMCC072CA0(1,3,4)  
AVMCC105CA0(1,3,4)  
AVMCC128CA0(1,3,4)  
AVMCC140CA0(1,3,4)

ENGLISH

ESPAÑOL

FRANÇAIS

**System Air Conditioner  
Aire acondicionado sistemático  
Climatiseur numérique multifonctionnel**

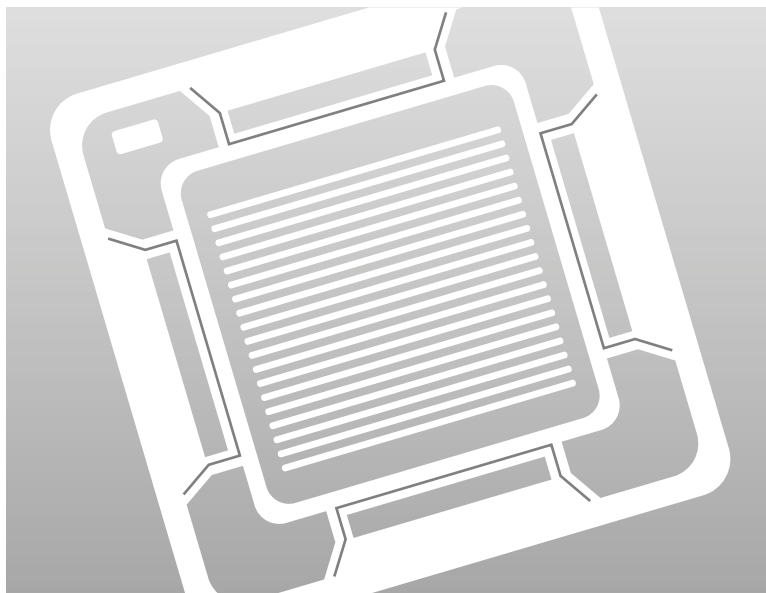

# Safety Precautions

*The following safety precautions must be taken when using your air conditioner.*



## **WARNING**

Risk of electric shock. • Can cause injury or death. • Disconnect all remote electric power supplies before servicing, installing or cleaning. • This must be done by the manufacturer or its service agent or a similar qualified person in order to avoid a hazard.

### DURING OPERATION

- ◆ Users of this product are cautioned not to attempt repair of this product at their own discretion. Instead, they are requested to directly contact a designated service center or the outlet at which the product was purchased.
- ◆ Never spill any kind of liquid into the unit. Should this happen, unplug or main switch off the unit and contact an authorized service center.
- ◆ Do not insert anything between the air outlet blades because the inner fan may be damaged and could cause injury. Keep children away from the unit.
- ◆ Do not place any obstacles in front of the unit.
- ◆ Do not spray liquid of any kind into the indoor unit. Should this happen, switch off the breaker used for your air conditioner and contact your installation specialist.
- ◆ Make sure that the unit is correctly ventilated at all times:  
Do not place clothing or other materials over it.
- ◆ If the wireless remote control will not be used for a long time, remove the batteries. (If applicable)
- ◆ When using a wireless remote control, the distance should not be more than 7 meters from the air conditioner. (If applicable)

### DISPOSING OF THE UNIT

- ◆ Before throwing out the device, it is necessary to pull back the battery cells and get rid of them safely for recycling reasons.
- ◆ When you need to dispose of the unit, consult your dealer. If pipes are removed incorrectly, refrigerant may blow out and come into contact with your skin, causing injury. Releasing refrigerant into the atmosphere also damages the environments.
- ◆ Please recycle or dispose of the packaging material for this product in an environmentally responsible manner.

### OTHERS

- ◆ Never store or ship the air conditioner upside down or sideways to avoid damage to the compressor.
- ◆ The appliance is not intended for use by young children or infirm persons without supervision: Young children should be supervised to ensure that they do not play with the appliance.
- ◆ Max current is measured according to IEC standard for safety and current is measured according to ISO standard for energy efficiency.

# Contents

---

◆ <b>PREPARING YOUR AIR CONDITIONER</b>	
■ Safety Precautions .....	2
■ View of the Unit .....	4
■ Wireless Remote Controller-Buttons and Display .....	6
■ Wired Remote Controller-Buttons and Display .....	7
■ Centralized Controller .....	8
◆ <b>RECOMMENDATIONS FOR USE</b>	
■ Operating Recommendations .....	9
■ Temperature and Humidity Ranges .....	10
■ Cleaning Your Air Conditioner .....	11
■ Bio-Pure Filter Installation (Optional) .....	12
■ Solving Common Problems .....	13
◆ <b>TECHNICAL SPECIFICATIONS</b>	

## View of the Unit

The figures shown in this instruction may differ from yours depending on the model.

### **Indoor Unit** TYPE A

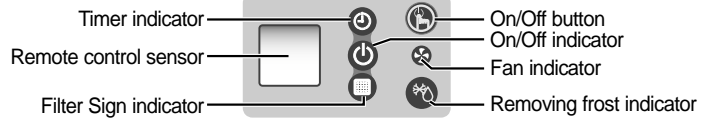
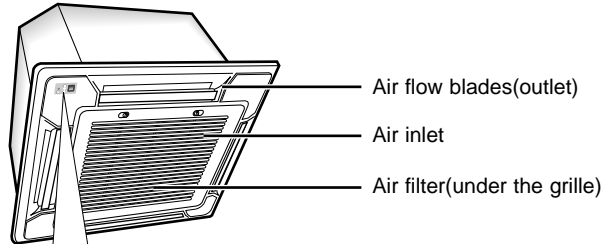

### **Indoor Unit** TYPE B

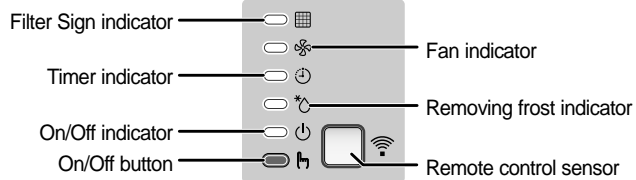
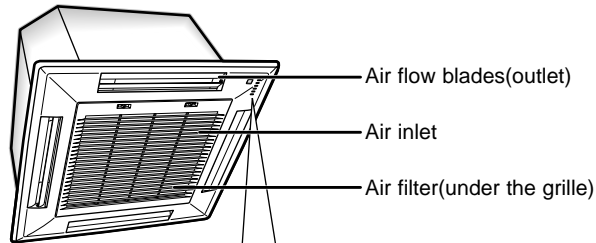

**Outdoor Unit** TYPE A

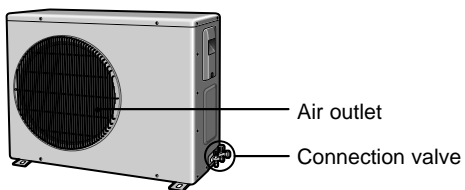

**Outdoor Unit** TYPE B

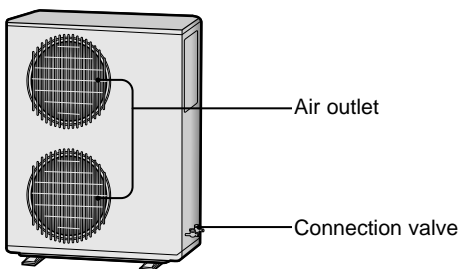

**Outdoor Unit** TYPE C

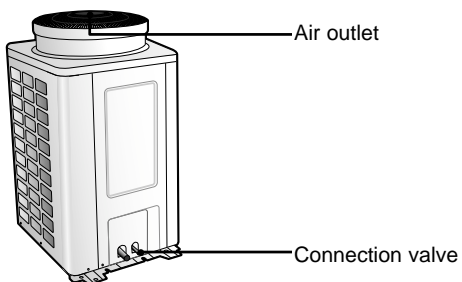

**Outdoor Unit** TYPE D

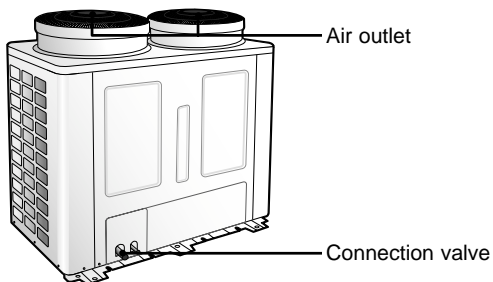

**Outdoor Unit** TYPE E

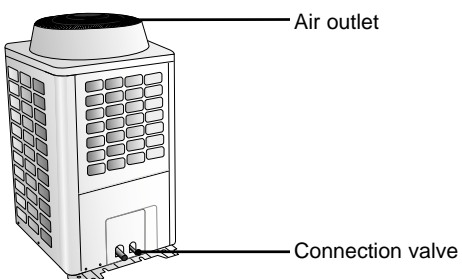

**Note** If the heat exchanger in the outdoor unit gets dusty, cooling efficiency may fall. So clean the heat exchanger with water when it becomes dirty. However, be careful when you wash the surface of the heat exchanger because it is very sharp.

## Wireless Remote Controller-Buttons and Display

The wireless remote controller is an optional accessory.  
To use the wireless remote controller, refer to an appropriate manual.

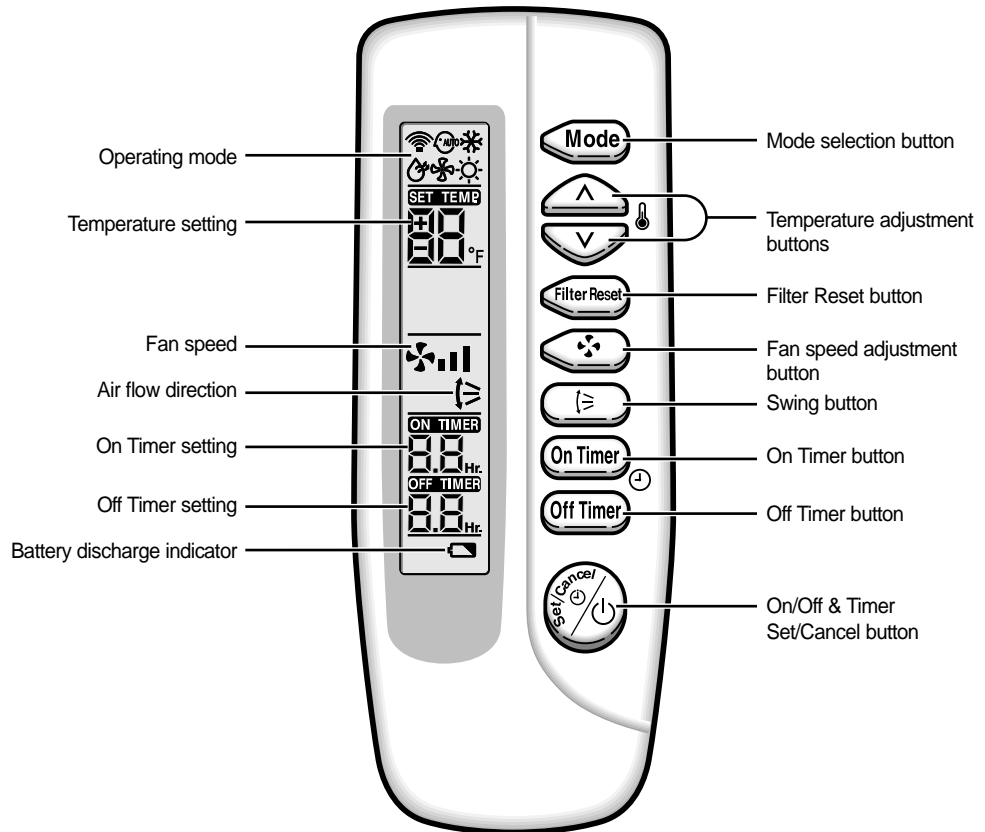

- Note**
- After cleaning the air filter, press the filter reset button.
  - The heating mode(☀) is not selected in cooling only models.

# Wired Remote Controller-Buttons and Display

The wired remote controller is an optional accessory and it is installed on the wall.  
To use the wired remote controller, refer to an appropriate manual.

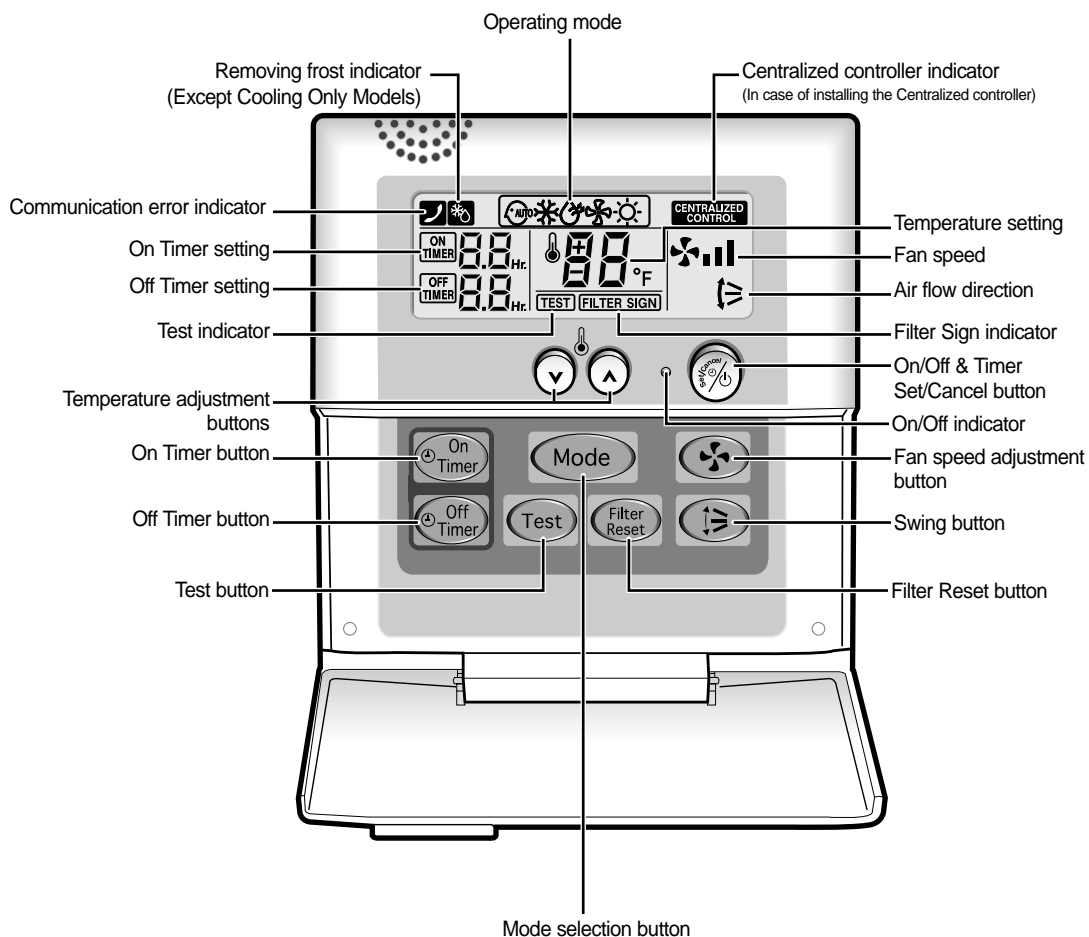

- Note**
- Test button is for your installation specialist. You must NOT press it.
  - After cleaning the air filter, press the filter reset button. Then the wired remote controller will display the FILTER SIGN indicator when the time to clean the air filter; refer to page 11.
  - The heating mode(☀) is not selected in cooling only models.

## Centralized Controller

The centralized controller is an optional accessory and it is installed on the wall.  
To use the centralized controller, refer to an appropriate manual.

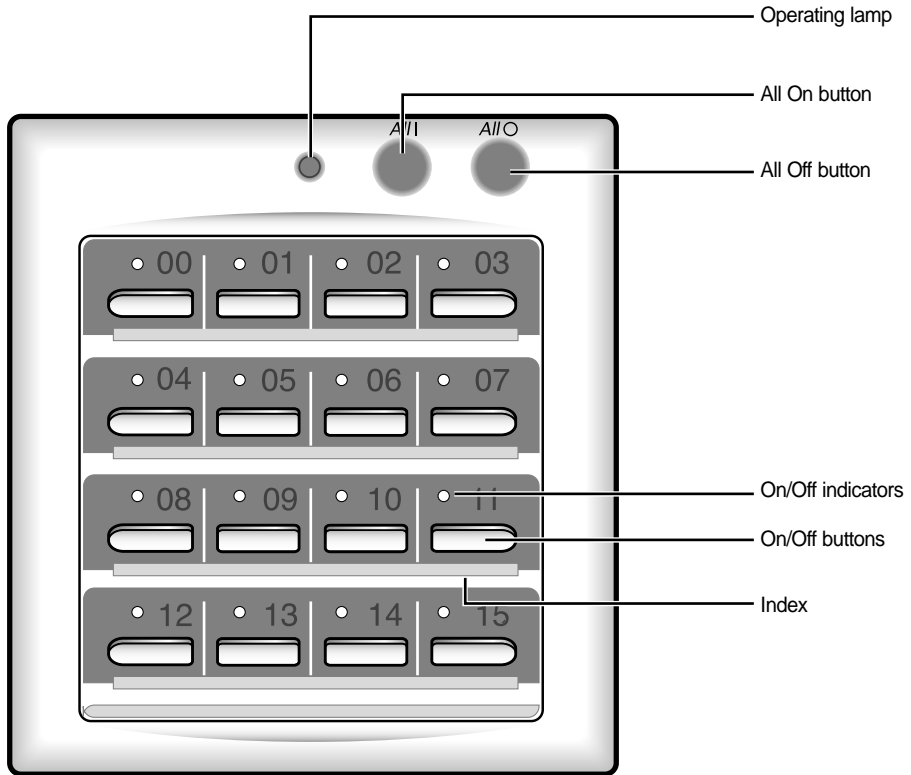

**Note** Operating lamp comes on when at least one air conditioner connected to the centralized controller is operating.



## Operating Recommendations

*Here are a few recommendations that you should follow when operating your air conditioner.*

Topic	Recommendation
Heating performances	The heat pump function of the air conditioner absorbs heat from outside air and brings it indoors. As the temperature of the outside air drops, the heating performance of air conditioner will decrease. If you find that the room is not warm enough, using an additional heating appliance is recommended.
Frost	When outside temperature is low but humidity is high, frost may form on the outdoor unit at HEAT mode. If this happens: <ul style="list-style-type: none"> <li>◆ The heating operation stops.</li> <li>◆ The defrost mode will be triggered automatically for about ten minutes.</li> </ul> No intervention is required ; after about ten minutes, the air conditioner operates again normally.
High indoor and outdoor temperatures	If both indoor and outdoor temperatures are high and the air conditioner is running at HEAT mode, the outdoor unit's fan and compressor may stop at times. This is normal ; simply wait until the air conditioner switches on again.
Power failure	If a power failure occurs while the air conditioner is operating, the unit will be switched off. When the power returns, the air conditioner starts up again automatically.

## Temperature and Humidity Ranges

*The following table indicates the temperature and humidity ranges, within which the air conditioner can be used.*

<b>If the air conditioner is used at...</b>	<b>Then...</b>
High temperature	The automatic protection feature may be triggered and the air conditioner stopped.
Low temperature	A water leakage or some other malfunction may happen if the heat exchanger freezes.
High humidity levels	Water may condense on and drip from the surface of the indoor unit if it is used for a long periods.

<b>Mode</b>	<b>Outdoor Temperature</b>	<b>Indoor Temperature</b>	<b>Indoor Humidity</b>
Heating	5°F to 75°F approx.	81°F or less	-
Cooling	23°F to 109°F approx.	70°F to 90°F approx.	80% or less
Drying	23°F to 109°F approx.	70°F to 90°F approx.	-

※ *The standardized temperature for heating is 45°F. If the outdoor temperature drops to 32°F or below, the heating capacity can be reduced depending on the temperature condition. If the cooling operation is used at over 90°F(indoor temperature), it does not cool at its full capacity.*

## Cleaning Your Air Conditioner

To get the best possible use out of your air conditioner, you must clean it regularly to remove the dust that accumulates on the air filter.

**IMPORTANT** Before cleaning your air conditioner, ensure that you have switched off the electric circuit breaker used for the unit.

1 Open the front grille by pushing the tabs on the grille.

**IMPORTANT** You must give attention when disassembling the front grille and must check the safety clips have been installed. If you do not check them, the front grille will drop suddenly and you will be hurt.

2 Remove the front grille.

2-1 Remove the safety clips.

2-2 Open the front grille about 45° and pull it forward.

3 Pull out the air filter.

4 Remove all dust on air filter with a vacuum cleaner or a brush. In case of serious dust accumulation, put the air filter in warm detergent water and shake it vertically.

**Note** When you have installed the Bio-Pure filter, do not allow any liquids to contact the filter. It may lose its properties.

5 Dry the air filter.

6 When you have finished, insert the filter into the front grille.

7 Clean the unit with a vacuum cleaner or a brush once a month.

8 Reinstall the front grille and the safety clips.

**Note** You can use all 4 points of the indoor unit for installing the front grille and the safety clips depending on your requirement.

**Note** After cleaning the air conditioner, press the Filter Reset button.

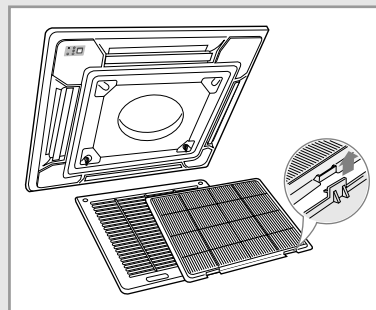
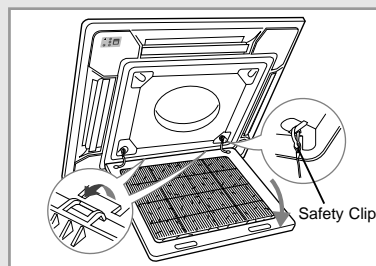
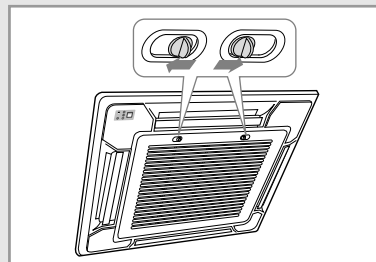

Wired Remote Controller

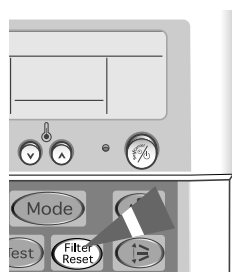

Wireless Remote Controller

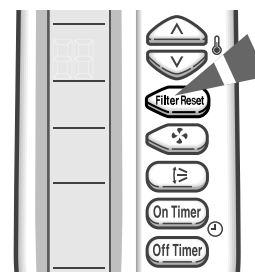

## Bio-Pure Filter Installation (Optional)

*The air conditioner can be fitted with a Bio-Pure filter to remove minute dust particles. The service life of the filter is approximately three months depending on the time during which the air conditioner is used.*

- 1 Remove the vinyl packing from the filter.

**Note** Do not remove the packing from a bio-pure filter until you wish to use the filter, as it will lose its properties.

- 2 Open the front grille by pulling the tabs on the grille.

- 3 Remove the front grille.

3-1 Remove the safety clips.

3-2 Open the front grille about 45° and pull it forward.

- 4 Pull out the air filter.

- 5 Locate the bio-pure filter on the center of air filter.

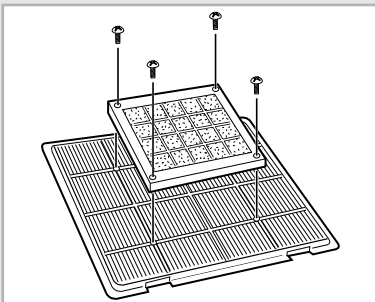

- 6 Secure the bio-pure filter with four screws.

- 7 Reinstall the air filter, the front grille and the safety clips.



## Solving Common Problems

*Before contacting the after-sales service, perform the following simple checks. They may save your time and expense of an unnecessary call.*

Problem	Explanation/Solution
The air conditioner does not operate at all	<ul style="list-style-type: none"> <li>◆ Check that the breaker used for the air conditioner is switched on.</li> </ul>
<b>Wired Remote Controller</b>	
The air conditioner does not operate with the remote controller	<ul style="list-style-type: none"> <li>◆  is displayed on the wired remote controller. In this case, turn the air conditioner off and contact your dealer.</li> </ul>
<b>Wired Remote Controller</b>	
When turning on/off the air conditioner, it is not turned on/off immediately.	<ul style="list-style-type: none"> <li>◆ In case of using the wired remote controller for a group, the air conditioners connected to the remote controller are turned on/off in order. Thus, it takes some time (up to 32 seconds).</li> </ul>
<b>Wireless Remote Controller</b>	
The air conditioner does not operate with the remote controller	<ul style="list-style-type: none"> <li>◆ Check that there are no obstacles between you and the remote control sensor.</li> <li>◆ Check the wireless remote controller batteries.</li> <li>◆ Check that you are close enough to the remote control sensor. (seven metres/yards or less).</li> </ul>
<b>Wireless Remote Controller</b>	
No beep is heard when you press  (ON/OFF) on the remote controller	<ul style="list-style-type: none"> <li>◆ Check that you are pointing the remote controller at the remote control sensor on the indoor unit.</li> <li>◆ Replace the remote controller batteries if necessary.</li> <li>◆ If there is a strong light around the air conditioner, a three-wavelength light, a neon sign, etc., for example, the air conditioner may not be operated with a remote controller. If this happens, use the remote controller close by the remote control sensor.</li> </ul>
The air conditioner does not cool or heat	<ul style="list-style-type: none"> <li>◆ Check that the correct operating mode has been selected.</li> <li>◆ The room temperature may be too low or too high.</li> <li>◆ Dust may be blocking the air filter guard; refer to page 11 for cleaning instructions.</li> <li>◆ Check that there is no obstacle in front of the outdoor unit.</li> </ul>
When heating, the required room temperature is never reached and the air conditioner frequently stops	<ul style="list-style-type: none"> <li>◆ Check that the required temperature has been set correctly.</li> <li>◆ Increase the fan speed.</li> </ul>

## Technical Specifications

Model	Power Supply
AVMCH052CA0(1,3,4)	1Ø, 208-230V~, 60Hz
AVMCH072CA0(1,3,4)	
AVMCH105CA0(1,3,4)	
AVMCH128CA0(1,3,4)	
AVMCH140CA0(1,3,4)	
AVMCC052CA0(1,3,4)	
AVMCC072CA0(1,3,4)	
AVMCC105CA0(1,3,4)	
AVMCC128CA0(1,3,4)	
AVMCC140CA0(1,3,4)	



**THIS AIR CONDITIONER IS MANUFACTURED BY:  
ESTE AIRE ACONDICIONADO HA SIDO FABRICADO POR:  
CE CLIMATISEUR EST FABRIQUE PAR:**





## Free Manuals Download Website

<http://myh66.com>

<http://usermanuals.us>

<http://www.somanuals.com>

<http://www.4manuals.cc>

<http://www.manual-lib.com>

<http://www.404manual.com>

<http://www.luxmanual.com>

<http://aubethermostatmanual.com>

Golf course search by state

<http://golfingnear.com>

Email search by domain

<http://emailbydomain.com>

Auto manuals search

<http://auto.somanuals.com>

TV manuals search

<http://tv.somanuals.com>