



# USER'S MANUAL

**Indoor Unit**  
**EH035CAV**  
**EH052CAV**  
**EH070CAV**

**Outdoor Unit**  
**UH035CAV**  
**UH052CAV**  
**UH070CAV**

ENGLISH  
ESPAÑOL  
FRANÇAIS

## **Slim Ducted Type Air Conditioner** **(Cooling and Heating)**

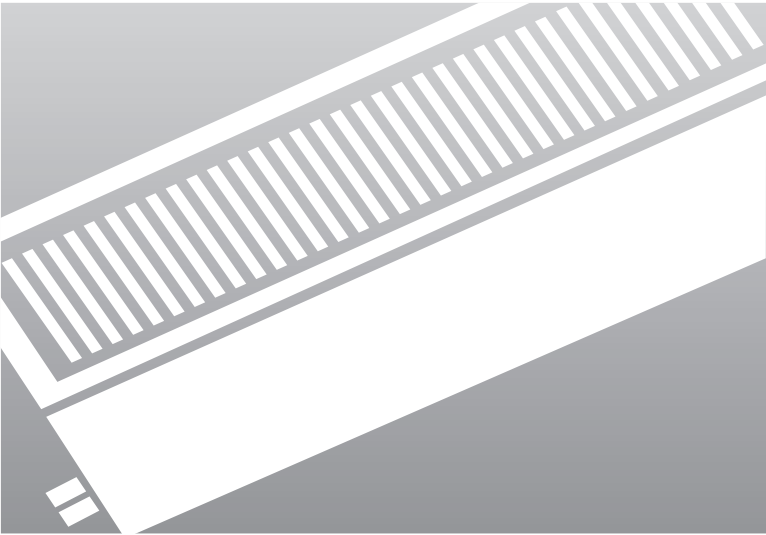

## Safety Precautions

*The following safety precautions must be taken when using your air conditioner.*



### **WARNING**

- Risk of electric shock can cause injury or death.
- Disconnect all remote electric power supplies before servicing, installing or cleaning.
- This must be done by the manufacturer or its service agent or a similar qualified person in order to avoid a hazard.

### **DURING OPERATION**

- ◆ Users of this product are cautioned not to attempt repair of this product at their own discretion. Instead, they are requested to directly contact a designated service center or the outlet at which the product was purchased.
- ◆ Never spill any kind of liquid into the unit. Should this happen, unplug or main switch off the unit and contact an authorized service center.
- ◆ Do not insert anything between the air outlet blades because the inner fan may be damaged and could cause injury. Keep children away from the unit.
- ◆ Do not place any obstacles in front of the unit.
- ◆ Do not spray liquid of any kind into the indoor unit. Should this happen, switch off the breaker used for your air conditioner and contact your installation specialist.
- ◆ Make sure that the unit is correctly ventilated at all times: Do not place clothing or other materials over it.
- ◆ If the wireless remote control will not be used for a long time, remove the batteries. (If applicable)
- ◆ When using a wireless remote control, the distance should not be more than 7 meters from the air conditioner. (If applicable)

### **DISPOSING OF THE UNIT**

- ◆ Before throwing out the device, it is necessary to pull back the battery cells and get rid of them safely for recycling reasons.
- ◆ When you need to dispose of the unit, consult your dealer. If pipes are removed incorrectly, refrigerant may blow out and come into contact with your skin, causing injury. Releasing refrigerant into the atmosphere also damages the environments.
- ◆ Please recycle or dispose of the packaging material for this product in an environmentally responsible manner.

### **OTHERS**

- ◆ Never store or ship the air conditioner upside down or sideways to avoid damage to the compressor.
- ◆ The appliance is not intended for use by young children or infirm persons without supervision: Young children should be supervised to ensure that they do not play with the appliance.
- ◆ Max current is measured according to IEC standard for safety and current is measured according to ISO standard for energy efficiency.

# Contents

---

## ◆ **PREPARING YOUR AIR CONDITIONER**

- Safety Precautions ..... 2
- View of the Unit ..... 4
- Wireless Remote Controller-Buttons and Display ..... 6
- The Receiver & Display Unit ..... 7
- Wired Remote Controller-Buttons and Display ..... 8

## ◆ **RECOMMENDATIONS FOR USE**

- Operating Recommendations ..... 9
- Temperature and Humidity Ranges ..... 10
- Cleaning Your Air Conditioner ..... 11
- Solving Common Problems ..... 12



### ***Correct Disposal of This Product (Waste Electrical & Electronic Equipment)***

#### **(Applicable in the European Union and other European countries with separate collection systems)**

This marking shown on the product or its literature, indicates that it should not be disposed with other household wastes at the end of its working life. To prevent possible harm to the environment or human health from uncontrolled waste disposal, please separate this from other types of wastes and recycle it responsibly to promote the sustainable reuse of material resources.

Household users should contact either the retailer where they purchased this product, or their local government office, for details of where and how they can take this item for environmentally safe recycling.

Business users should contact their supplier and check the terms and conditions of the purchase contract.

This product should not be mixed with other commercial wastes for disposal.

## View of the Unit

The figures are shown in this instruction may differ from yours depending on the model.

### **Indoor Unit**    \*\*035\*\*

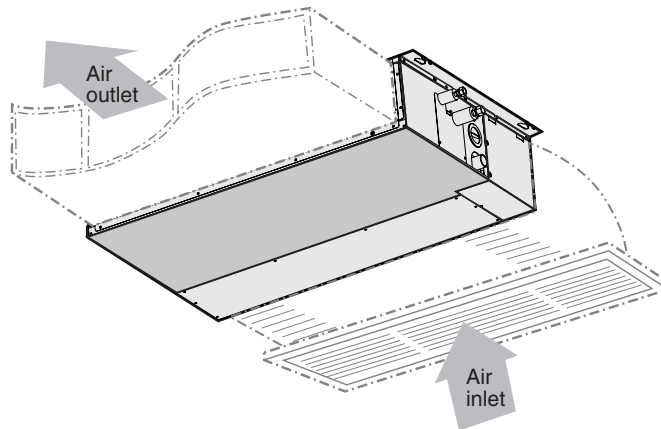

### **Indoor Unit**    \*\*052/070\*\*

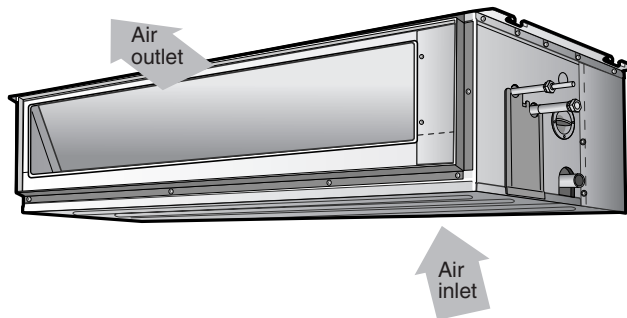

**Outdoor Unit**

\*\*035\*\*

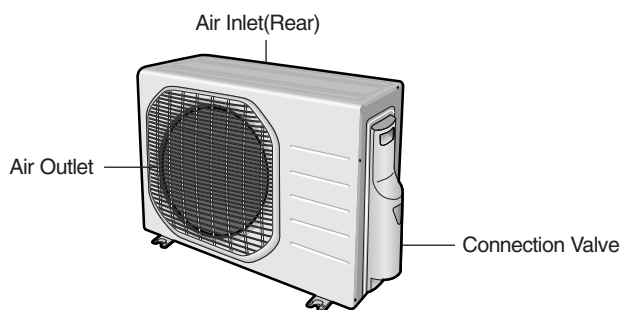
**Outdoor Unit**

\*\*052\*\*

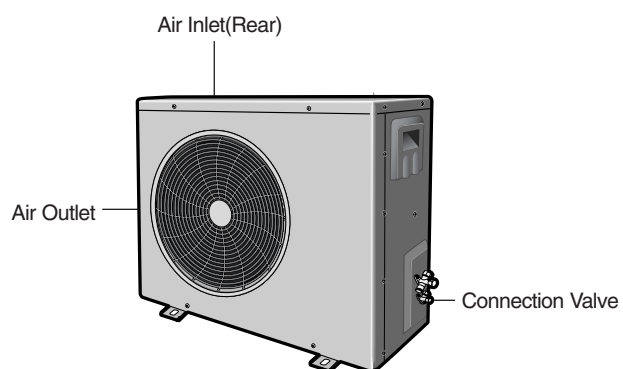
**Outdoor Unit**

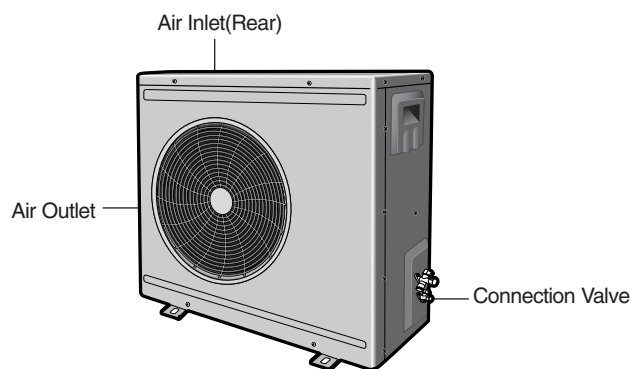

\*\*070\*\*

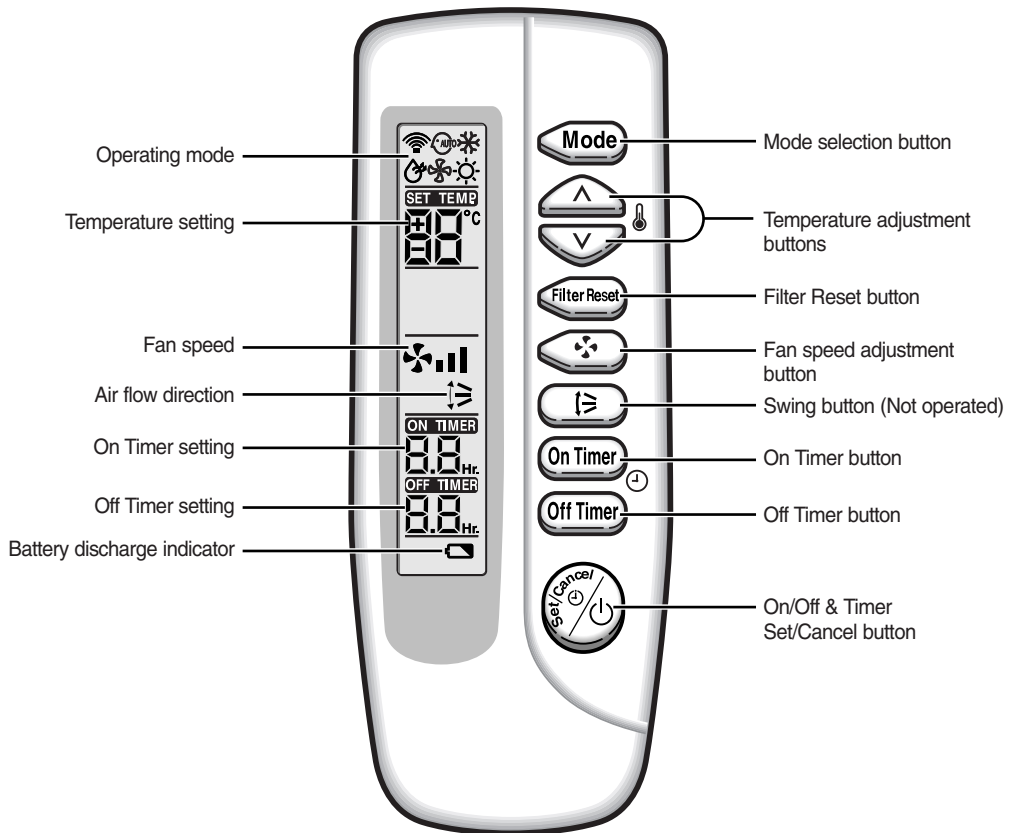

## Wireless Remote Controller-Buttons and Display

The wireless remote controller is an optional accessory.  
To use the wireless remote controller, refer to an appropriate manual.



- Note**
- ◆ After cleaning the air filter, press the  button.
  - ◆ Duct type air conditioner does not have function of adjusting air flow direction. Therefore, the function is not operated even if you press the  button.

# The Receiver & Display Unit

The Receiver & Display unit is an optional accessory and it is installed on the wall.  
To use the receiver & display unit, refer to an appropriate manual.

## Concealed Type

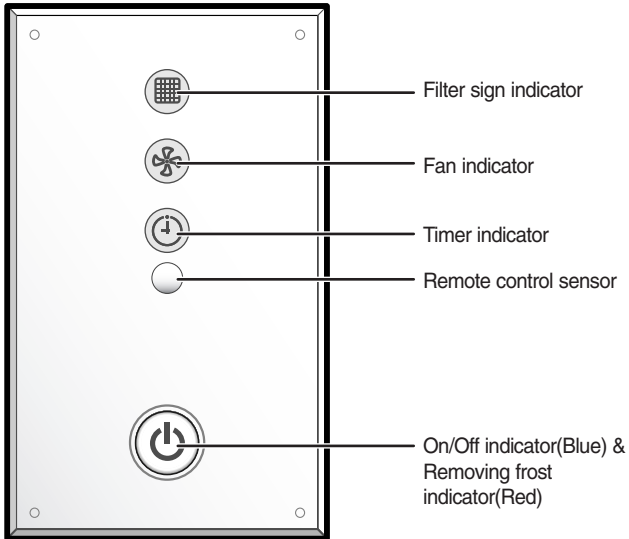

## Standard Type

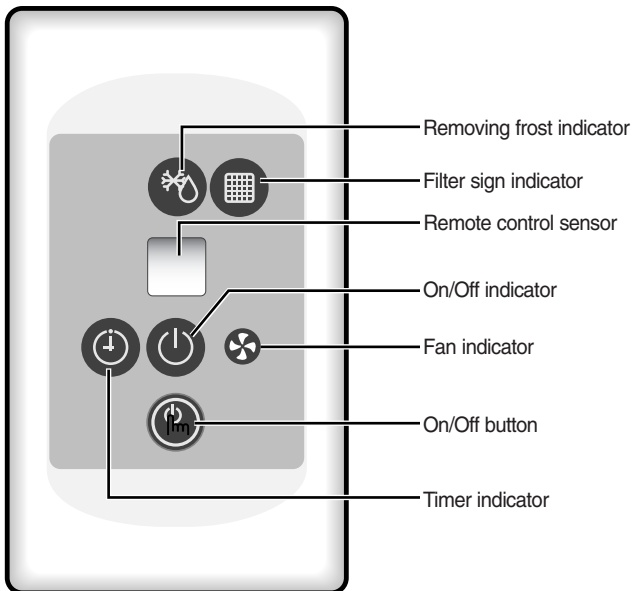

# Wired Remote Controller-Buttons and Display

To use the wired remote controller, refer to an appropriate manual.

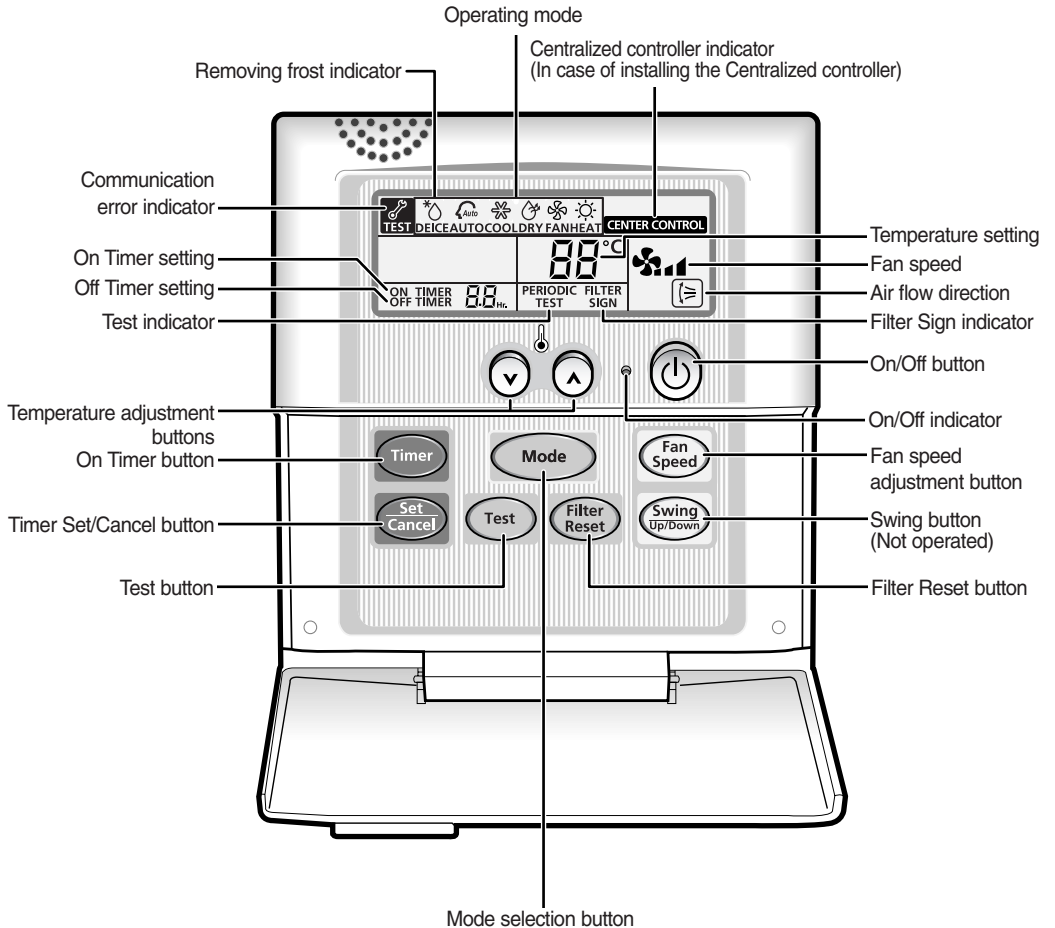

- Note**
- ◆ The **Test** button is for your installation specialist. You must NOT press it.
  - ◆ After cleaning the air filter, press the **Filter Reset** button. Then the wired remote controller will display the FILTER SIGN indicator when the time to clean the air filter; refer to page 13.
  - ◆ Duct type air conditioner does not have function of adjusting air flow direction. Therefore, the function is not operated even if you press the **Swing Up/Down** button.



# Operating Recommendations

**Here are a few recommendations that you should follow when operating your air conditioner.**

Topic	Recommendation
Heating performances	The heat pump function of the air conditioner absorbs heat from outside air and brings it indoors. As the temperature of the outside air drops, the heating performance of air conditioner will decrease. If you find that the room is not warm enough, using an additional heating appliance is recommended.
Frost	When outside temperature is low but humidity is high, frost may form on the outdoor unit at HEAT mode. If this happens: <ul style="list-style-type: none"><li>◆ The heating operation stops.</li><li>◆ The defrost mode will be triggered automatically for 3 to 14 minutes.</li></ul> No intervention is required ; after about 7 minutes, the air conditioner operates again normally.
High indoor and outdoor temperatures	If both indoor and outdoor temperatures are high and the air conditioner is running at HEAT mode, the outdoor unit's fan and compressor may stop at times. This is normal ; simply wait until the air conditioner switches on again.
Power failure	If a power failure occurs while the air conditioner is operating, the unit will be switched off. When the power returns, the air conditioner starts up again automatically.
Cooling operation	The indoor unit may not get the selected fan speed such as Medium and Low under cooling operation at very low outdoor temperatures for protecting the indoor unit from ice or frost. During Low fan speed operation, cooling performance will be reduced. If the room does not cool down when using Low fan speed operation, please adjust the indoor unit's fan speed.

## Temperature and Humidity Ranges

*The following table indicates the temperature and humidity ranges, within which the air conditioner can be used.*

If the air conditioner is used at...	Then...
High temperature	The automatic protection feature may be triggered and the air conditioner stopped.
Low temperature	A water leakage or some other malfunction may happen if the heat exchanger freezes.
High humidity levels	Water may condense on and drip from the surface of the indoor unit if it is used for a long periods.

Mode	Outdoor Temperature	Indoor Temperature	Indoor Humidity
Heating	14°F to 75°F	80°F or less	-
Cooling	23°F to 109°F	64°F to 89°F	80% or less
Drying	23°F to 109°F	64°F to 89°F	-

※ *If the outdoor temperature is as low as 0°C, the heating capacity drops up to 70~80% depending on the operating condition.  
If you use the air conditioner over 32°C(indoor temperature), the cooling capacity may drop.*

# Cleaning Your Air Conditioner

**For the best use of your air conditioner, you must clean it every 2 weeks regularly to remove the dust that accumulates on the air filter.**

**CAUTION** Before cleaning your air conditioner, ensure that you have switched off the electric circuit breaker used for the unit.

- 1 Turn the levers to the right or left not to prevent pulling out the air filter. (\*\*035\*\*) Pull the air filter to the right or left as you want. (\*\*052/070\*\*)
- 2 Pull out the air filter.
- 3 Remove all dust on air filter with a vacuum cleaner or a brush. In case of serious dust accumulation, put the air filter in warm detergent water and shake it vertically.
- 4 Dry the air filter.
- 5 When you have finished, insert the filter into the unit.

**Note**

- ◆ After cleaning the air conditioner, press the Filter Reset button.
- ◆ Do not operate the air conditioner without the filter.

\*\*035\*\* (Optional)

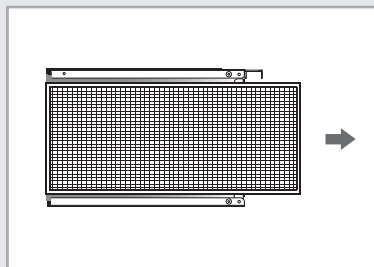
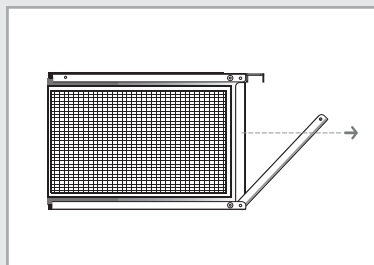

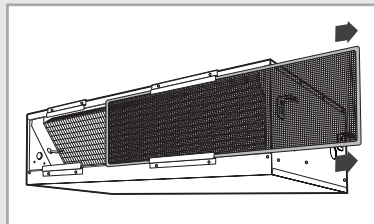
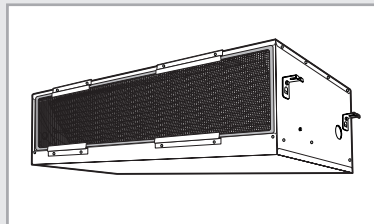

\*\*052/070\*\* (Optional)



# Solving Common Problems

**Before contacting the after-sales service, perform the following simple checks. They may save your time and expense of an unnecessary call.**

Problem	Explanation/Solution
The air conditioner does not operate at all	<ul style="list-style-type: none"> <li>◆ Check that the breaker used for the air conditioner is switched on.</li> </ul>
<b>Wired Remote Controller</b> The air conditioner does not operate with the remote controller	<ul style="list-style-type: none"> <li>◆  is displayed on the wired remote controller. In this case, turn the air conditioner off and contact your dealer.</li> </ul>
<b>Wired Remote Controller</b> When turning on/off the air conditioner, it is not turned On/Off immediately.	<ul style="list-style-type: none"> <li>◆ In case of using the wired remote controller for a group, the air conditioners connected to the remote controller are turned on/off in order. Thus, it takes some time(up to 32 seconds).</li> </ul>
<b>Wireless Remote Controller</b> The air conditioner does not operate with the remote controller	<ul style="list-style-type: none"> <li>◆ Check that there are no obstacles between you and the remote control sensor.</li> <li>◆ Check the wireless remote controller batteries.</li> <li>◆ Check that you are close enough to the remote control sensor. (7 metres/ yards or less).</li> </ul>
<b>Wireless Remote Controller</b> No beep is heard when you press  (On/Off) on the remote controller	<ul style="list-style-type: none"> <li>◆ Check that you are pointing the remote controller at the remote control sensor of the receiver &amp; display unit.</li> <li>◆ Replace the remote controller batteries if necessary.</li> </ul>
The air conditioner does not cool or heat	<ul style="list-style-type: none"> <li>◆ Check that the correct operating mode has been selected.</li> <li>◆ The room temperature may be too low or too high.</li> <li>◆ Dust may be blocking the air filter guard; refer to page 11 for cleaning instructions.</li> <li>◆ Check that there is no obstacle in front of the outdoor unit.</li> </ul>
When heating, the required room temperature is never reached and the air conditioner frequently stops	<ul style="list-style-type: none"> <li>◆ Check that the required temperature has been set correctly.</li> <li>◆ Increase the fan speed.</li> </ul>

# Memo

---

A series of horizontal lines for writing, consisting of a solid top line and a dashed bottom line for each row.



**If you have any comments or questions regarding Samsung products,  
contact the SAMSUNG customer care center.**

Samsung Electronics America, Inc.

1-800-SAMSUNG (7267864)

[www.samsung.com](http://www.samsung.com)

## Free Manuals Download Website

<http://myh66.com>

<http://usermanuals.us>

<http://www.somanuals.com>

<http://www.4manuals.cc>

<http://www.manual-lib.com>

<http://www.404manual.com>

<http://www.luxmanual.com>

<http://aubethermostatmanual.com>

Golf course search by state

<http://golfingnear.com>

Email search by domain

<http://emailbydomain.com>

Auto manuals search

<http://auto.somanuals.com>

TV manuals search

<http://tv.somanuals.com>