



**SAMSUNG**

# **COLOUR TELEVISION**

**25A6**

**29A5/29A6/29A7  
29K3/29K5//29K10  
29M6/29U2/29Z4**

**34A7/34Z4**

## **Owner's Instructions**

Before operating the unit,  
please read this manual thoroughly,  
and retain it for future reference.

**REMOTE CONTROL  
ON-SCREEN MENUS  
PICTURE IN PICTURE FUNCTION  
TELETEXT FUNCTION**

ENG

## Safety Instructions

ENG

The following illustrations represent the precautions to be taken when using and moving your television.

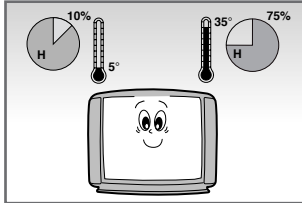

Do NOT expose the television to extreme temperature conditions or to extreme humidity conditions.

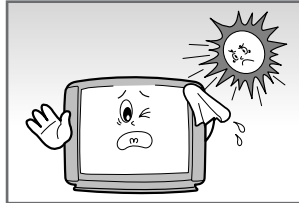

Do NOT expose the television to direct sunlight.

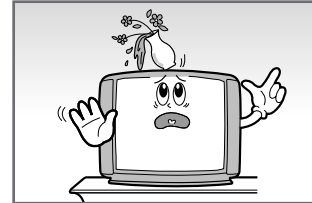

Do NOT expose the television to any liquids.

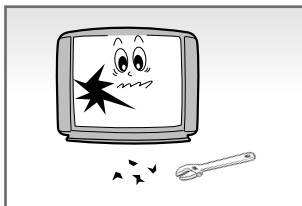

If the television is broken, do not try to repair it yourself. Contact qualified service personnel.

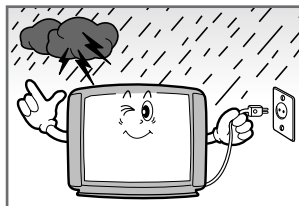

During a storm conditions (especially when there is lightning) unplug the television from the mains socket and aerial.

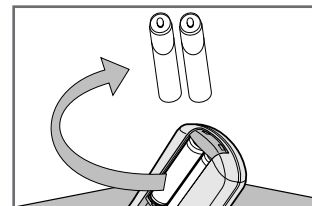

If the remote control is not used for a long period of time, remove the batteries and store it in a cool, dry place.

**THIS DEVICE IS NOT FOR USE IN INDUSTRIAL ENVIRONMENTS**

➤ Please use a soft and dry cloth (not containing volatile matter) when you clean the TV.

## Caution

**CAUTION**  
RISK OF ELECTRIC SHOCK  
DO NOT OPEN

**CAUTION: TO PREVENT ELECTRICAL SHOCK, DO NOT REMOVE REAR COVER, NO USER SERVICEABLE PARTS INSIDE. REFER SERVICING TO QUALIFIED SERVICE PERSONNEL.**

The lightning flash and arrow head within the triangle is a warning sign alerting you of "dangerous voltage" inside the product.

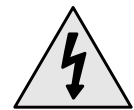

The exclamation point within the triangle is a warning sign alerting you of important instructions accompanying the product.



**WARNING: TO PREVENT DAMAGE WHICH MAY RESULT IN FIRE OR SHOCK HAZARD. DO NOT EXPOSE THIS APPLIANCE TO RAIN OR MOISTURE.**

The main voltage is indicated on the rear of the TV set and the frequency is 50 or 60Hz.

Mode	System
CZ	PAL-B/G, D/K, I, SECAM-B/G,D/K, I, NTSC4.43
CW	PAL-B/G, D/K, I, SECAM-B/G,D/K, I, L/L', NTSC4.43
CS	PAL-B/G, D/K, I, SECAM-B/G,D/K, I, NTSC4.43/3.58

# Contents

ENG

◆ <b>PREPARING YOUR TELEVISION</b>	
■ Safety Instructions .....	2
■ Caution .....	2
■ Front Control Panel .....	4
■ Connection Panels .....	5
■ Infrared Remote Control (All Functions Except Teletext & PIP) .....	6
■ Infrared Remote Control (Teletext & PIP Functions) .....	7
■ Inserting the Batteries in the Remote Control.....	8
■ Connecting the Aerial (or Cable Television Network).....	8
■ Switching Your Television On and Off.....	9
■ Placing Your Television in Standby mode .....	9
■ Plug & Play Feature.....	10
■ Viewing the Demonstration.....	11
■ Choosing Your Language.....	12
◆ <b>SETTING UP THE CHANNELS</b>	
■ Storing the Channels Automatically.....	13
■ Storing the Channels Manually.....	14
■ Giving Channels Names.....	16
■ Skipping Unwanted Channels .....	17
■ Fine tuning Channel Reception .....	18
■ Sorting the Stored Channels .....	19
◆ <b>USING THE TELEVISION</b>	
■ Changing the Picture Standard .....	20
■ Adjusting the Picture Settings.....	21
■ Selecting the Picture Format .....	21
■ Activation/Deactivation the Digital Noise Reduction Feature .....	22
■ Using the Tilt Control Feature (Option).....	22
■ Freezing the Current Picture (Option) .....	23
■ Changing the Sound Standard .....	23
■ Adjusting the Sound Settings .....	24
■ Extra Sound Settings.....	25
■ Selecting the Sound Mode .....	26
■ Selecting the Turbo Sound .....	26
■ Adjusting the Volume.....	27
■ Switching the Sound Off Temporarily .....	27
■ Using the LNA (Low Noise Amplifier) Feature (Option).....	27
■ Setting the Sleep Timer .....	28
■ Setting and Displaying the Current Time.....	28
■ Switching the Television On and Off Automatically .....	29
■ Setting the Blue Screen Mode.....	30
■ Activating the Childlock .....	30
■ Picture In Picture .....	31
◆ <b>USING THE TELETXT FUNCTION</b>	
■ Teletext Decoder .....	33
■ Displaying Teletext Information .....	33
■ Selecting a Specific Teletext Page .....	34
■ Using FLOF to Select a Teletext Page .....	35
■ Storing Teletext Pages .....	35
◆ <b>INFORMATION ON CONNECTIONS AND RECOMMENDATIONS FOR USE</b>	
■ Connecting to the AV-1 or 2 Input/Outputs.....	36
■ Connecting to the S-VIDEO Input.....	36
■ Connecting to the DVD Input.....	37
■ Connecting to the RCA Input.....	37
■ Connecting Headphones .....	38
■ Viewing Picture From External Sources .....	38
■ Automatic Degaussing to Remove Colour Patches.....	39
■ Trouble Shooting: Before Contacting Service Personnel .....	39

Symbols



Press



Important



Note



# Connection Panels

This figure shows the Standard Connector-jack panel.  
The actual configuration on your TV may be different, depending on the model.

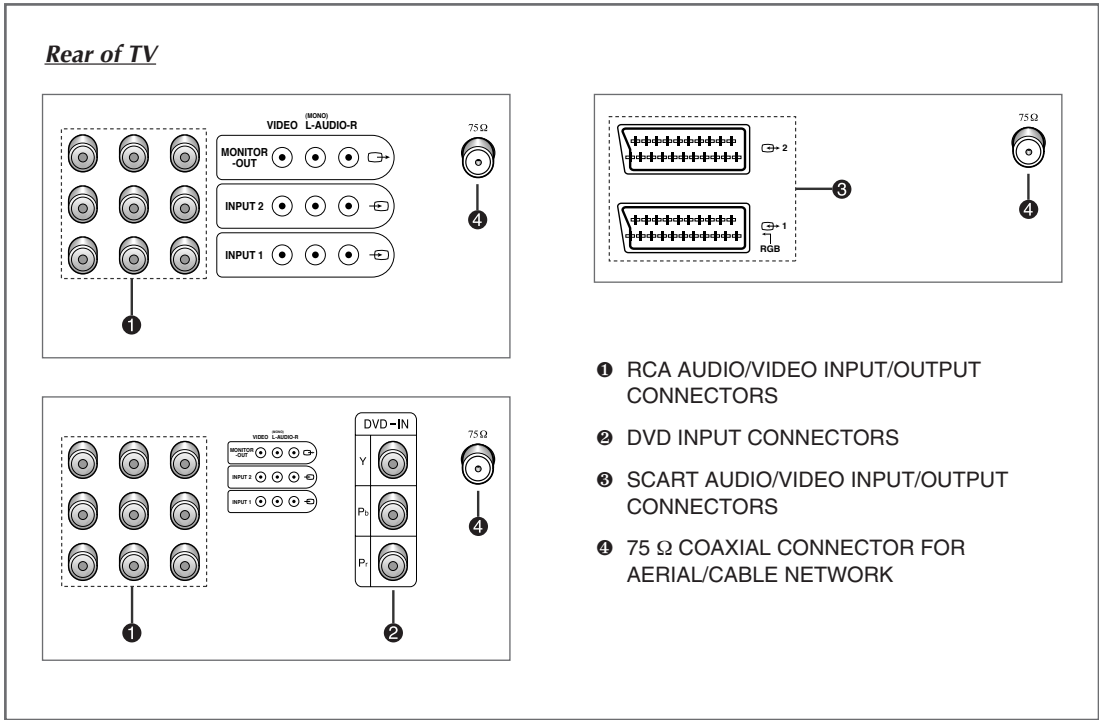
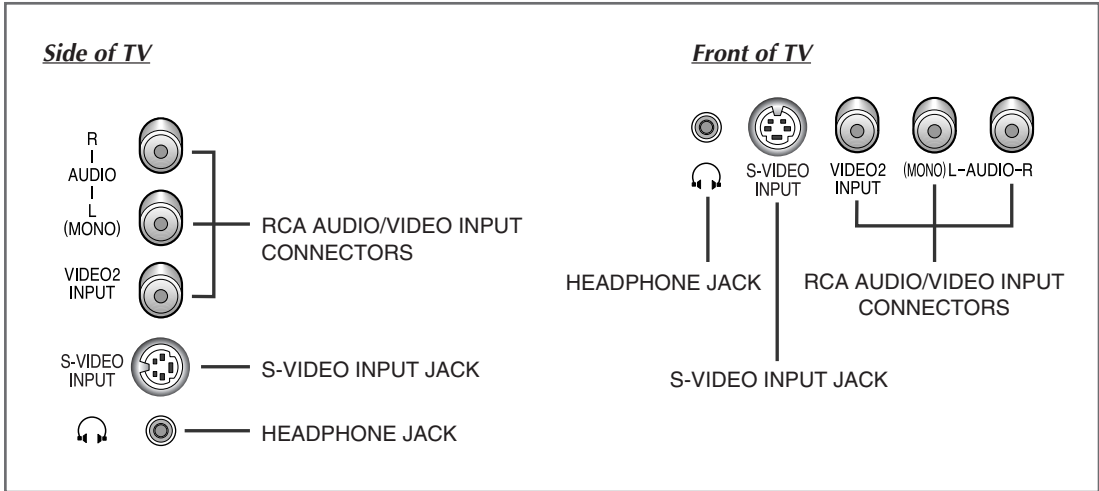

## Infrared Remote Control (All Functions Except Teletext & PIP)

ENG

➤ Buttons and markings are subject to change.

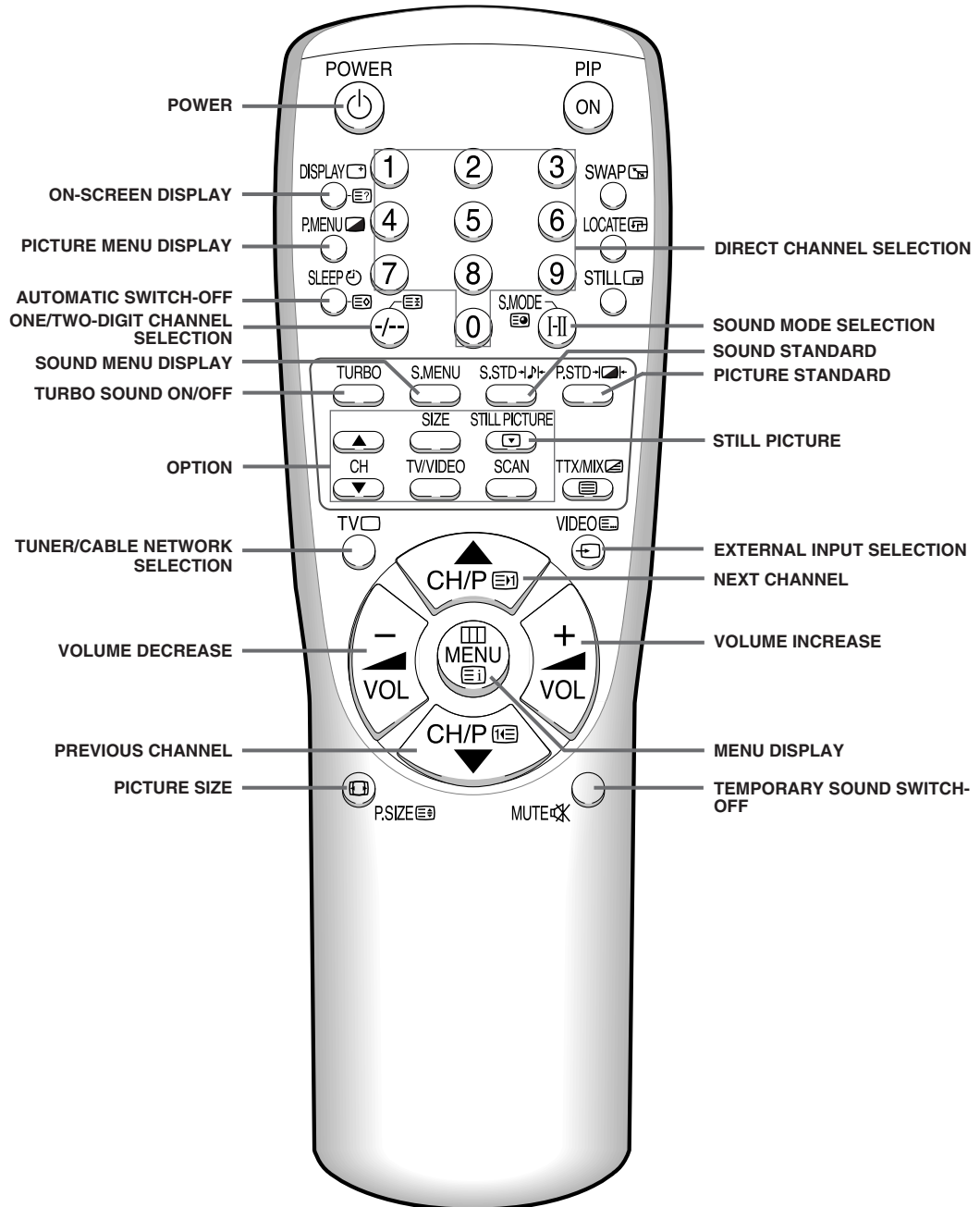

➤ Operation of remote control may be affected by bright artificial light near to the TV set.

## Infrared Remote Control (Teletext & PIP Functions)

➤ Buttons and markings are subject to change.

ENG

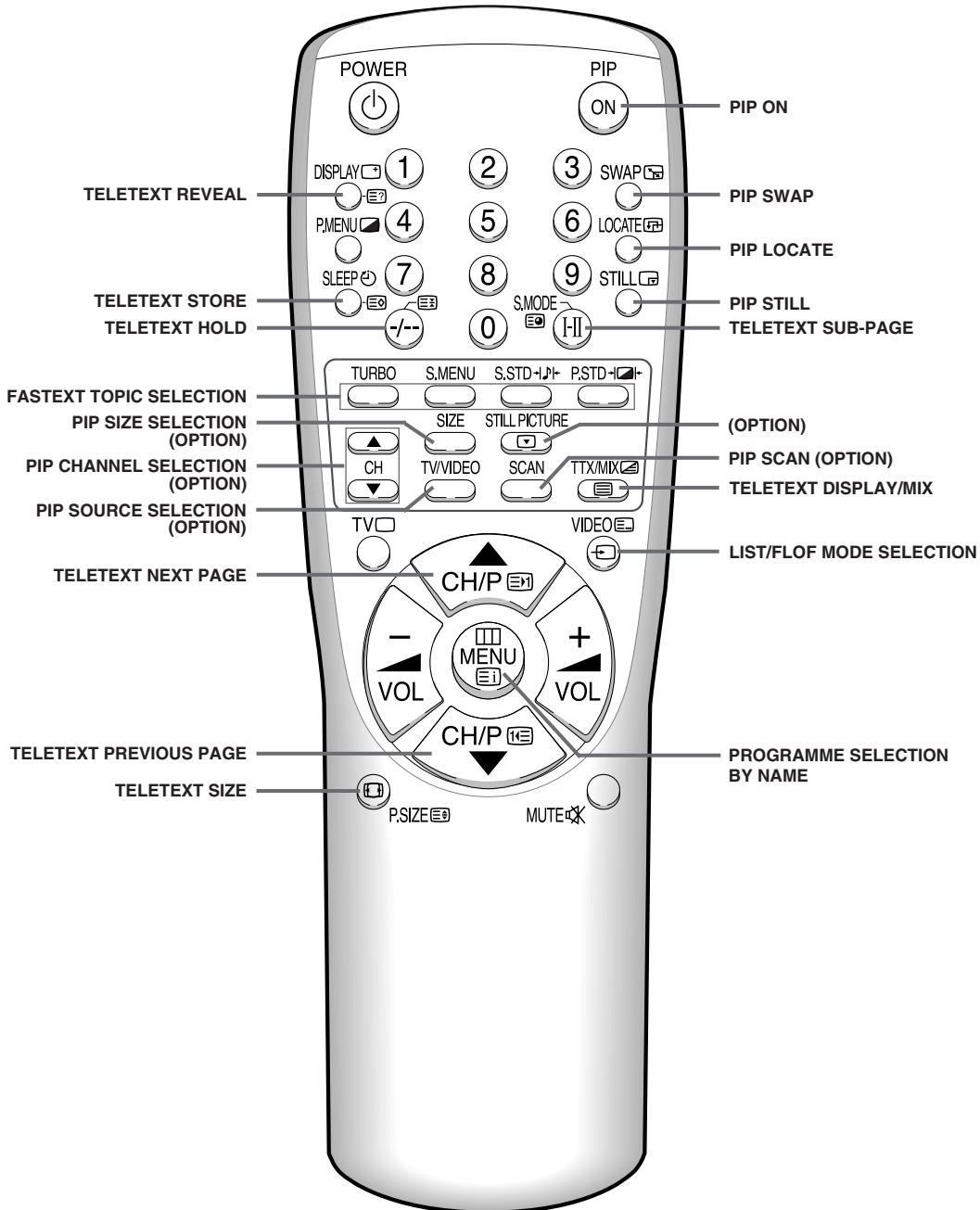

## Inserting the Batteries in the Remote Control

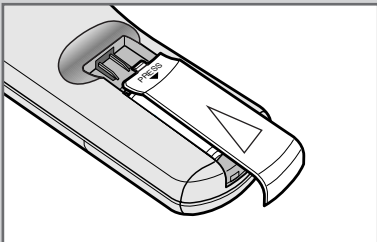
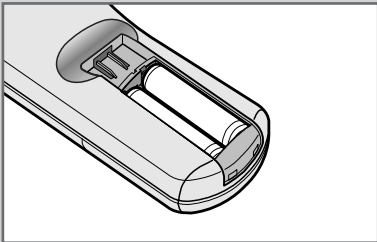
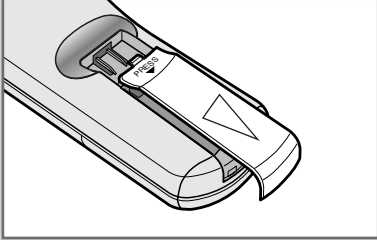

*You must insert or replace the batteries in the remote control when you :*

- ◆ *Purchase the television.*
- ◆ *Find that the remote control is no longer operating correctly.*

- 1 Remove the cover of the remote control by pressing the symbol (PRESS) and pulling the cover in the direction of the arrow.
- 2 Insert batteries, taking care to respect the polarities:
  - ◆ + on the battery with + on the remote control
  - ◆ - on the battery with - on the remote control
- 3 Replace the cover by pushing it in the direction of the arrow.

## Connecting the Aerial (or Cable Television Network)

*To view television channels correctly, a signal must be received by the set from one of the following sources:*

- ◆ *An outdoor aerial*
- ◆ *A cable television network*

Plug the aerial or cable network input cable to the 75Ω coaxial socket on the rear of the television.

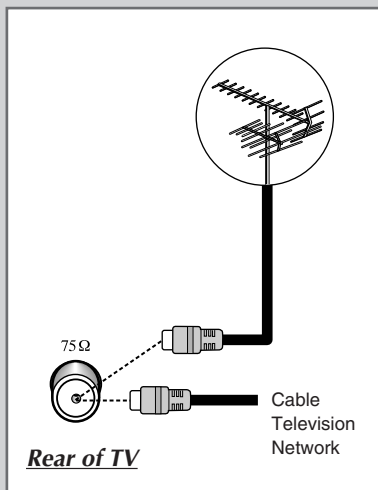



## Switching Your Television On and Off

ENG

*The mains lead is attached to the rear of the television.*

- 1 Plug the mains lead into an appropriate socket.
  - The main voltage is indicated on the rear of the TV set and the frequency is 50 or 60Hz.
- 2 Press the **POWER** ⏻ (ON/OFF) button on the front of the television.  
**Result:** The Standby indicator lights up on the front panel.
- 3 Press the **POWER** ⏻ button on the remote control to switch the television on.  
**Result:** The programme that you were watching last is re-selected automatically.
- 4 To switch your television off, press the **POWER** ⏻ (ON/OFF) button again on the front of the television.

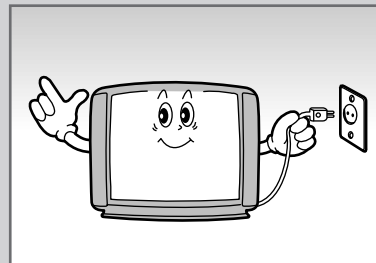

## Placing Your Television in Standby mode

*Your television can be placed in Standby mode, in order to reduce:*

- ◆ **Power consumption**
- ◆ **Wear of the cathode ray tube**

*The Standby mode can be useful when you wish to interrupt viewing temporarily (during a meal, for example).*

*The television is placed automatically in Standby mode when you turn it on.*

- 1 Press the **POWER** ⏻ button on the remote control.  
**Result:** The screen is turned off and the Standby indicator on the front of the television lights up.
- 2 To switch the screen back on, simply press the **POWER** ⏻ button again on the remote control.

- Do not leave your television in standby mode for long periods of time (when you are away on holiday, for example). In this case, you should switch it off completely.



## Plug & Play Feature

Plug & Play

Ant. Input : Check

⏏ Select    ⏏ Exit

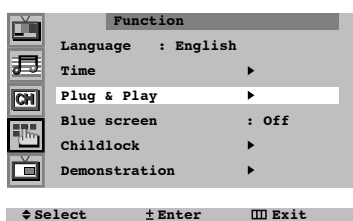
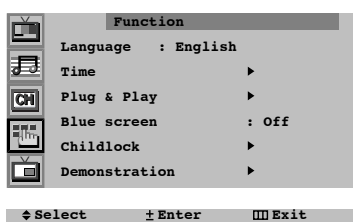
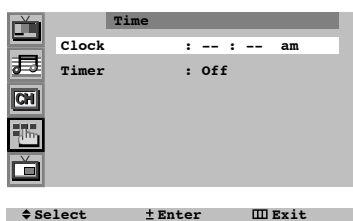

*When the television is initially powered ON, three basic customer settings proceed automatically and subsequently: setting the language, channel and clock.*

- 1 If the television is in Standby mode (red light visible on the television front panel), press the **POWER**  button on the remote control.

**Result:** The message “Plug & Play” is displayed. It flickers for a little while and then the “Language” menu is automatically displayed.

- 2 Press the **▲** or **▼** button to select required language. Press the **MENU** button to enter the language, and then the message “Ant. Input : Check” is displayed.

➤ If any language is not selected on the “Language” menu, the “Language” menu will be displayed about 30 seconds later.

- 3 Make sure that the antenna is connected to the TV. And then press the **+** or **-** button.

**Result:** The “Auto store” menu is displayed.

- 4 Select your country by pressing the **+** or **-** button. To search the channels, select the “Search” by pressing the **▲** or **▼** button, and then press the **+** or **-** button (refer to “Storing the Channels Automatically” on page 13). Press the **MENU** button to skip.

**Result:** The “Time” menu is displayed.

- 5 Press the **+** or **-** button to move to the hour or minute. Set the hour or minute by pressing the **▲** or **▼** button (refer to “Setting and Displaying the Current Time” on page 28).

- 6 When you have finished, press the **MENU** button.

**Result:** The message “ENJOY YOUR WATCHING” is displayed, and then the channel which has been stored will be activated.

### 7 If you want to reset this feature...

- 1 Press the **MENU** button.

- 2 Press the **▲** or **▼** button to select the “Function”, and then press the **+** or **-** button.

- 3 Select the “Plug & Play” by pressing the **▲** or **▼** button, and then press the **+** or **-** button.

**Result:** The message “Plug & Play” is displayed.

## Viewing the Demonstration

To become familiar with the various menus provided by your television, you can view the inbuilt demonstration.

- 1 Press the **MENU** button.
- 2 Press the **▲** or **▼** button to select the "Function" and press the **+** or **-** button.
- 3 Press the **▲** or **▼** button to select the "Demonstration" and press the **+** or **-** button.

Result: Each of the menu options is displayed in turn.

- 4 When you wish to stop the demonstration, press any button on the remote control.

ENG

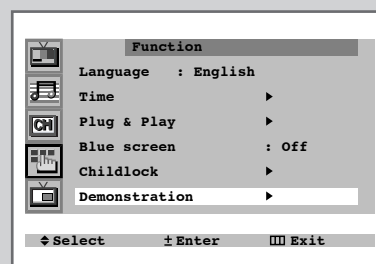
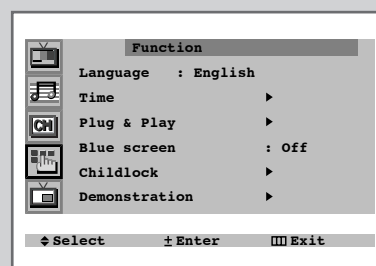
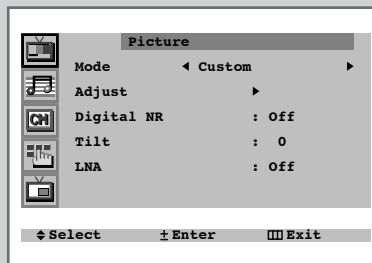

## Choosing Your Language

ENG

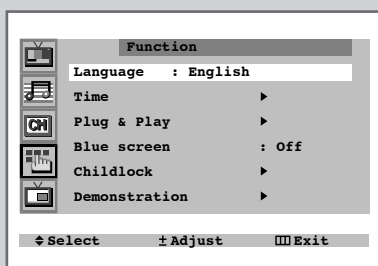
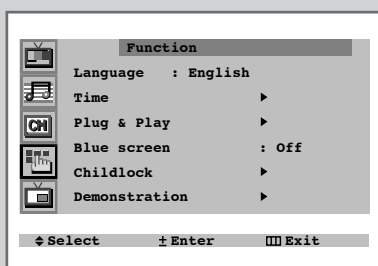
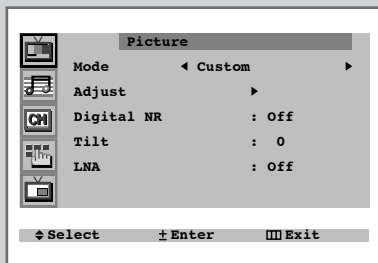

*When you start using your television for the first time, you must select the language which will be used for displaying menus and indications.*

- 1 Press the **MENU** button.
- 2 Press the ▲ or ▼ button to select the "Function".
- 3 Press the + or – button to select the "Language".
- 4 Select a particular language by pressing the ▲ or ▼ button repeatedly.
- 5 When you have finished, press the **TV** button, or press the **MENU** button repeatedly to return to normal viewing.

## Storing the Channels Automatically

ENG

You can scan the frequency ranges available on your television and in your area and store all the channels found automatically.

The channels are stored in the order in which they appear in the frequency bands. It is possible that the automatically allocated numbers may not correspond to those by which you wish to identify the channels. If this is the case, refer to "Sorting the Stored Channels" on page 19.

- 1 Press the **MENU** button.
- 2 Press the **▲** or **▼** button to select the "Channel".
- 3 Press the **+** or **-** button to select the "Auto store".
- 4 Press the **+** or **-** button again.

**Result:** The "Auto store" menu is displayed with the "Area" selected.

- 5 Select your country by pressing the **+** or **-** button. The following countries are available: ASIA W/EUROPE - CIS E/EUROPE - CHINA - HONGKONG U/K - AUSTRALIA - NZ/INDONESIA - SOUTH AFRICA - AMERICA.
- 6 Press the **▲** or **▼** button to select the "Search" and press the **+** or **-** button.

**Result:** The horizontal bar is displayed, and then channels are stored in an order which reflects their positions in the frequency range. Finally, the search will end automatically.

- 7 When searching and storing is complete, the "Sort" menu is displayed.

To...	Then...
Sort the stored channels into the desired numerical order	Go to Step 4 of the "Sorting the Stored Channels" procedure on page 19.
Exit the channel store function without sorting the channels	Press the <b>MENU</b> button repeatedly until the menus disappear.

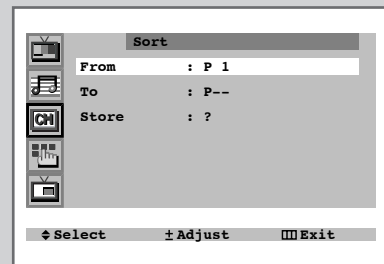
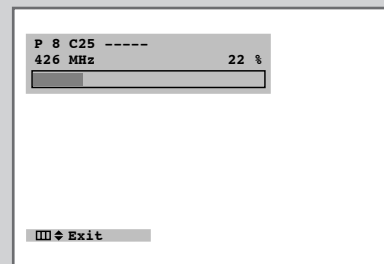
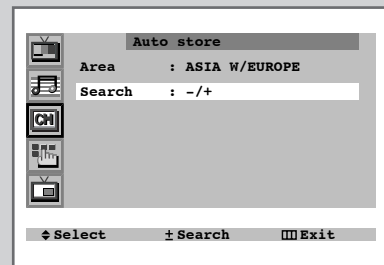
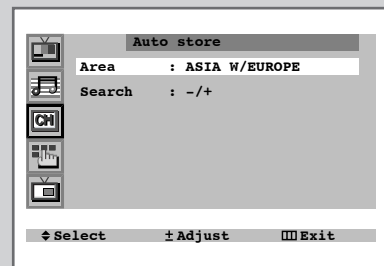
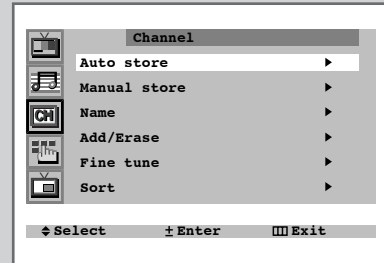

## Storing the Channels Manually

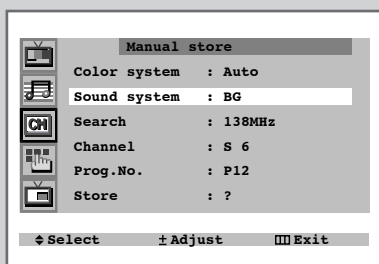
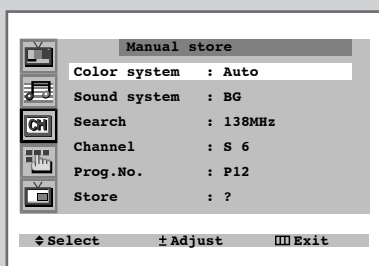
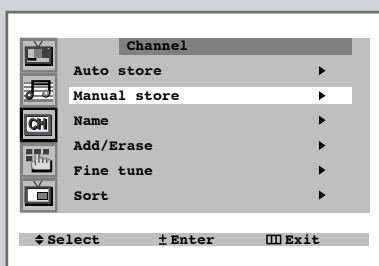
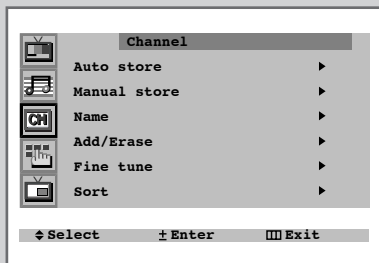

When storing channels manually, you can choose:

- ◆ Whether or not to store each of the channels found.
- ◆ The number by which you wish to identify each stored channel.

- 1 Press the **MENU** button.
  - 2 Press the **▲** or **▼** button to select the “Channel” and press the **+** or **-** button.
  - 3 Press the **▲** or **▼** button to select the “Manual store” and press the **+** or **-** button.
- Result: The “Manual store” menu is displayed with the “Color system” selected.
- 4 Press the **+** or **-** button repeatedly until the color is of the best quality.

Result: The “Color system” is changed.

**Auto ↔ PAL ↔ SECAM ↔ NT4.43 ↔ NT3.58** (option)



➤ NT4.43 is a “trick” playback mode used by special VCR’s to play PAL-recorded videos in NTSC mode.

- 5 Press the **▲** or **▼** button to select the “Sound system” and press the **+** or **-** button repeatedly until the sound is of the best quality.

Result: The “Sound system” is changed.

**BG ↔ DK ↔ I ↔ M** (option)



## Storing the Channels Manually (continued...)

ENG

### 6 If you know the number of the channel to be stored, press the...

1. ▲ or ▼ button to select the "Channel".
2. + button.
3. ▲ or ▼ button to select the "C" (Air channel) or "S" (Cable channel).
4. + button.
5. ▲ or ▼ button to select the channel.

#### ➤ If no sound or abnormal sound...

1. Press the + button.
2. Press the ▲ or ▼ button to select the "Sound system".
3. Select the "BG", "DK", "I" or "L" by pressing the + or - button.

### If you do not know the channel numbers, press the...

1. ▲ or ▼ button to select the "Search".
2. + or - button to start the search.

**Result:** The tuner scans the frequency range until the first channel or the channel that you selected is received on your screen.

### 7 To assign a programme number to the channel, select the "Prog.No.". Press the + or - button until you find the correct number.

### 8 To store the channel and associated programme number, select the "Store" and press the + or - button.

**Result:** "OK" is displayed.

### 9 Repeat Steps 6 to 8 for each channel to be stored.

### 10 When you have finished manual storage, press the TV button, or press the MENU button repeatedly to return to normal viewing

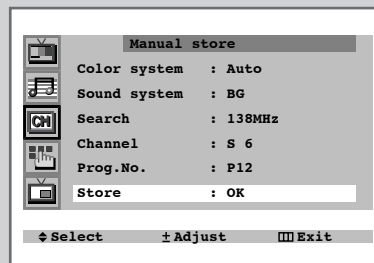
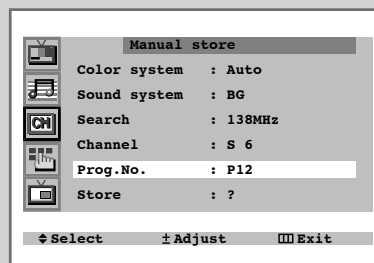
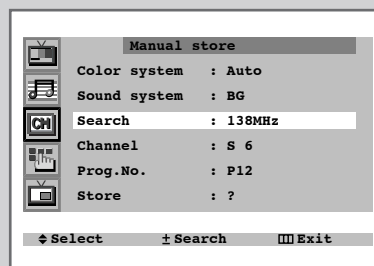
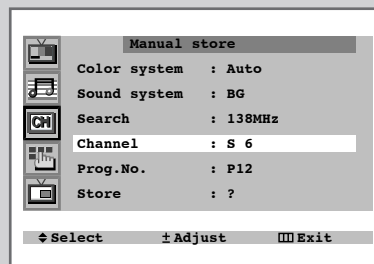

## Giving Channels Names

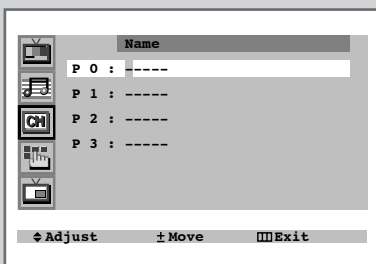
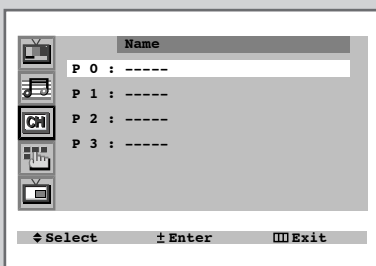
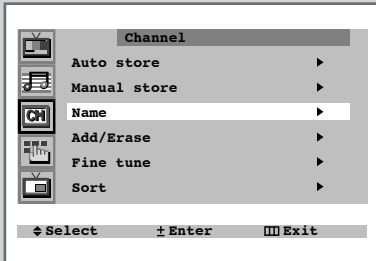

*If you want edit the name, you can assign new names as required.*

- 1 Press the **MENU** button.
- 2 Press the ▲ or ▼ button to select the “Channel” and press the + or – button.
- 3 Press the ▲ or ▼ button to select the “Name” and press the + or – button.
- 4
 

To...	Press the...
Select a letter or number	▼ or ▲ button.
Move on the next letter	+ button.
Move back the previous letter	– button.

  - The characters available are:
    - ◆ Letters of the alphabet (A...Z)
    - ◆ Numbers (0...9)
    - ◆ Special characters (space, –)
- 5 You can have each channel newlynamed.
- 6 When you have finished entering the name, press the **TV** button, or press the **MENU** button repeatedly to return to normal viewing.



## Skipping Unwanted Channels

You can exclude the channels of your choice from the channel scan operation. When you scan through the stored channels, those you have chosen to skip are not displayed.

All channels that you do not specifically choose to skip are displayed during scanning.

- 1 Press the **MENU** button.
- 2 Press the **▲** or **▼** button to select the "Channel" and press the **+** or **-** button.
- 3 Press the **▲** or **▼** button to select the "Add/Erase" and press the **+** or **-** button.  
Result: The "Add/Erase" menu is displayed.
- 4 Press the **▲** or **▼** button to select the required channel.
- 5 To add or erase the desired channel by pressing the **+** or **-** button.
- 6 When you have finished adding and erasing channels, press the **TV** button, or press the **MENU** button repeatedly to return to normal viewing

ENG

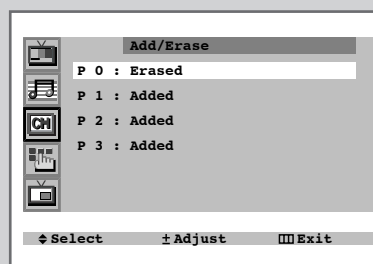
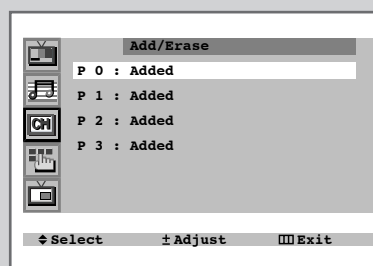
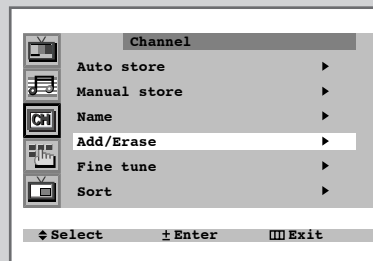

## Fine tuning Channel Reception

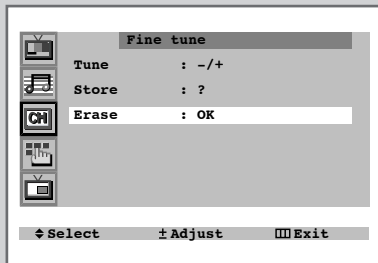
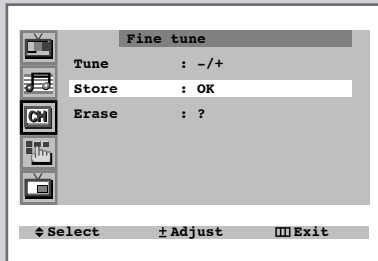
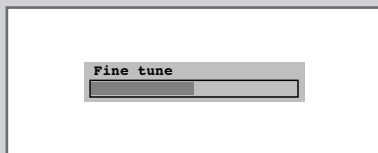
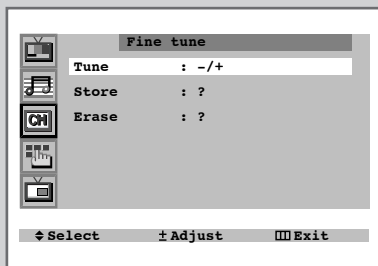
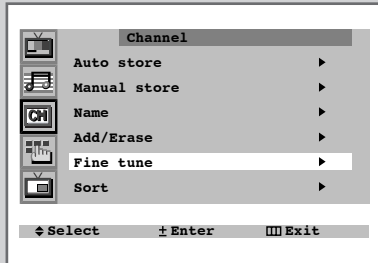

*If the reception is clear, you do not have to fine-tune the channel, as this is done automatically during the search and store operation. If however the signal is weak or distorted, you may have to fine-tune the channel manually.*

- 1 Press the **MENU** button.
- 2 Press the **▲** or **▼** button to select the "Channel" and press the **+** or **-** button.
- 3 Press the **▲** or **▼** button to select the "Fine tune" and press the **+** or **-** button.

Result: The "Fine tune" menu is displayed with the "Tune" selected.

- | 4 To...   | Press the...  |
|---|---|
| obtain a sharp and clear picture and good sound quality | <ul style="list-style-type: none"> <li>◆ <b>+</b> or <b>-</b> button.</li> <li><u>Result:</u> The horizontal bar's cursor moves to the left or right.</li> </ul>                          |
| memorise adjusted picture or sound                      | <ul style="list-style-type: none"> <li>◆ <b>▲</b> or <b>▼</b> button to select the "Store".</li> <li>◆ <b>+</b> or <b>-</b> button.</li> <li><u>Result:</u> "OK" is displayed.</li> </ul> |
| erase adjusted picture or sound                         | <ul style="list-style-type: none"> <li>◆ <b>▲</b> or <b>▼</b> button to select the "Erase".</li> <li>◆ <b>+</b> or <b>-</b> button.</li> <li><u>Result:</u> "OK" is displayed.</li> </ul> |
- 5 When you have finished, press the **TV** button, or press the **MENU** button repeatedly to return to normal viewing.

## Sorting the Stored Channels

ENG

You can exchange the numbers of two channels, in order to:

- ◆ *Modify the numeric order in which the channels have been automatically stored.*
- ◆ *Give easily remembered numbers to the channels that you watch most often.*

- 1 Press the **MENU** button.

---

- 2 Press the ▲ or ▼ button to select the “Channel” and press the + or – button.

---

- 3 Press the ▲ or ▼ button to select the “Sort” and press the + or – button.  
  
Result: The “Sort” menu is displayed with the “From” selected.

---

- 4 Press the + or – button until the channel number that you wish to change is displayed.  
  
Result: The selected channel’s picture is displayed.

---

- 5 Press the ▲ or ▼ button to select the “To”.

---

- 6 Press the + or – button until the new number by which you wish to identify the channel is displayed.  
  
Result: The selected channel is exchanged with the one previously stored to the chosen number.  
  
Example: If you select “P 1” for the “From” and “P 3” for the “To”:
  - ◆ Channel 1 becomes channel 3.
  - ◆ Channel 3 becomes channel 1.

---

7 To...	Press the...
Confirm the exchange of channel numbers	<ul style="list-style-type: none"> <li>◆ ▲ or ▼ button to select the “Store”.</li> <li>◆ + or – button.</li> </ul> <u>Result:</u> “OK” is displayed. ➤ You can exchange other channel numbers by selecting “From” and returning to step 4.

---

- 8 When you have finished sorting channels, press the **TV** button, or press the **MENU** button repeatedly to return to normal viewing

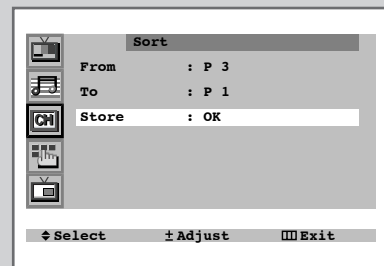
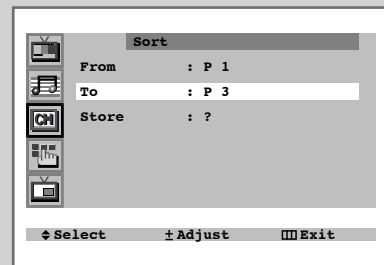
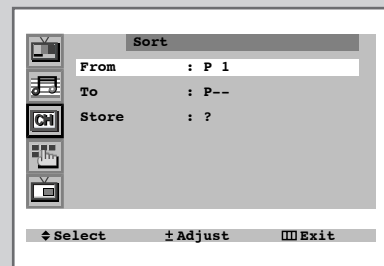
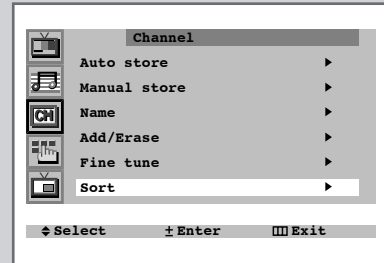

## Changing the Picture Standard

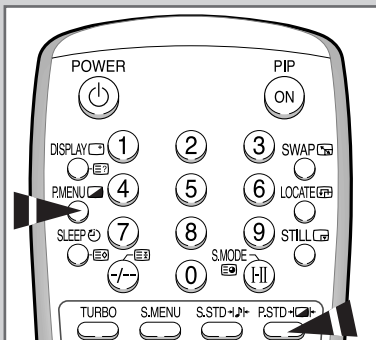
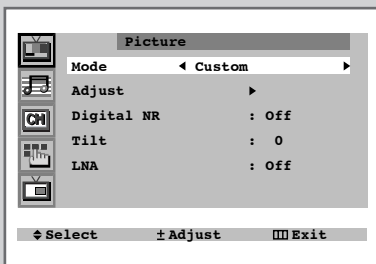
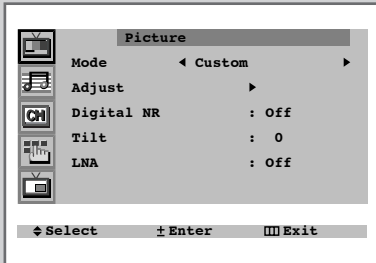

You can select the type of picture which best corresponds to your viewing requirements. The following picture effects are available in the order given:

◆ *Custom, Standard, Sports, Natural, Mild.*

- 1 Press the **MENU** button.  
Result: The "Picture" menu is displayed.
- 2 Press the **+** or **-** button to select the "Mode".
- 3 Press the **+** or **-** button repeatedly to cycle through the five choices: **Custom, Standard, Sports, Natural, Mild.**
- 4 When you are satisfied with the settings, press the **TV** button, or press the **MENU** button repeatedly to return to normal viewing.

You can use your remote control to select the type of picture which best corresponds to your viewing requirements.

To select the required picture effect, simply press the **P.STD** (Picture standard) button on the remote control.

Result: The following picture effects are available in the order given:

**Custom ↔ Standard ↔ Sports ↔ Natural ↔ Mild**

➤ You can display the picture menu directly by pressing the "P.MENU" (Picture menu) button on the remote control.

## Adjusting the Picture Settings

Your television has several settings which allow you to control picture quality:

- ◆ **Color tone, Contrast, Brightness, Color, Sharpness, Tint (NTSC only)**

- 1 Press the **MENU** button.  
Result: The "Picture" menu is displayed.
- 2 Press the **+** or **-** button.
- 3 Press the **▲** or **▼** button to select the "Adjust", and then press the **+** or **-** button.  
Result: The "Adjust" menu is displayed.  
➤ When select the "Mode" to "Custom", the "Adjust" menu is displayed.
- 4 

To adjust the...	Press the...
◆ Color tone	◆ <b>+</b> or <b>-</b> button. <u>Result:</u> You select the required option (Normal, Warm1/2, Cool1/2).
◆ Contrast	◆ <b>+</b> or <b>-</b> button. <u>Result:</u> The horizontal bar is displayed.
◆ Brightness	
◆ Sharpness	
◆ Color	
◆ Tint (NTSC only)	
- 5 When you are satisfied with the settings, press the **TV** button, or press the **MENU** button repeatedly to return to normal viewing.

- The television has an "automatic degaussing" system that is activated if magnetic interference is present. To degauss the television screen, switch power off by pressing the "POWER ⏻" (ON/OFF) button on the front panel (refer to "Automatic Degaussing To Remove Colour Patches" on page 39).
- If you make any changes to the "Adjust" settings, the picture standard is automatically switched to "Custom".

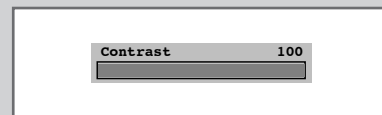
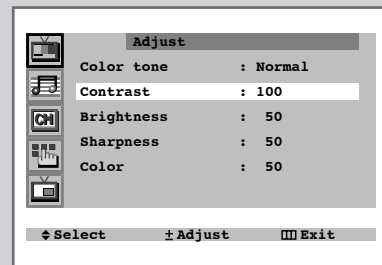
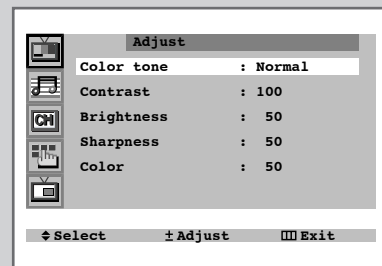
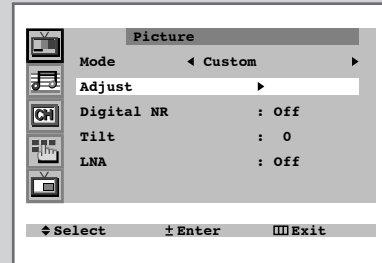

## Selecting the Picture Format (depending on the model)

You can select the picture format which best corresponds to your viewing requirements by simply pressing the "P.SIZE" button.

Picture format	Description
<b>Plus</b>	Full 12.8:9 format (extra 1 inch)
<b>Normal</b>	Setting for normal 4:3 format.
<b>Zoom</b>	Expansion of a 16:9 picture to full screen format.
<b>16:9</b>	Setting for the 16:9 screen format

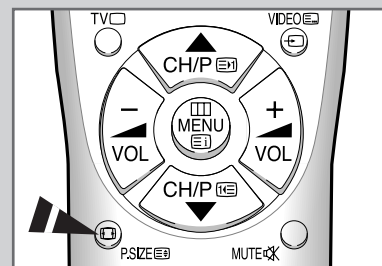

## Activating/Deactivating the Digital Noise Reduction Feature

*If the broadcast signal received by your television is weak, you can activate the Digital Noise Reduction feature to help reduce any static and ghosting that may appear on the screen.*

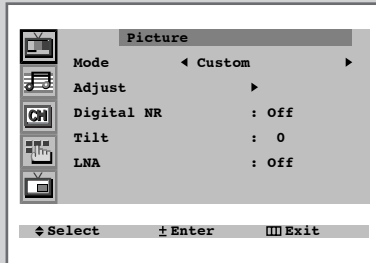

- 1 Press the **MENU** button.

Result: The "Picture" menu is displayed.

- 2 Press the **+** or **-** button.

- 3 Press the **▲** or **▼** button to select the "Digital NR".

- 4 To select the "On" by pressing the **+** or **-** button.

- 5 When you have finished, press the **TV** button, or press the **MENU** button repeatedly to return to normal viewing.

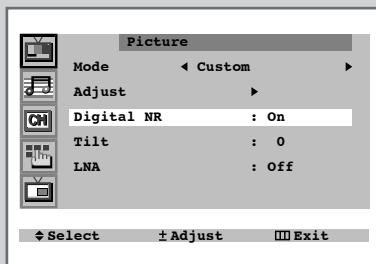

## Using the Tilt Control Feature (Option)

*If you find that the picture received is slightly tilted to one side, you can adjust the tilt setting.*

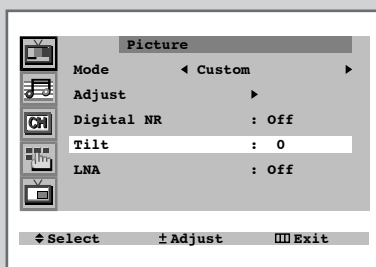

- 1 Press the **MENU** button.

Result: The "Picture" menu is displayed.

- 2 Press the **+** or **-** button.

- 3 Press the **▲** or **▼** button to select the "Tilt".

- 4 To adjust the "Tilt" ( $\pm 7$ ) by pressing the **+** or **-** button.

- 5 When you are satisfied with the settings, press the **TV** button, or press the **MENU** button repeatedly to return to normal viewing.

## Freezing the Current Picture (Option)

You can freeze the picture when watching a television programme.

To...	Press the...
Freeze the picture on a given frame	<b>STILL PICTURE</b> button.
Return to normal viewing	<b>STILL PICTURE</b> button again.

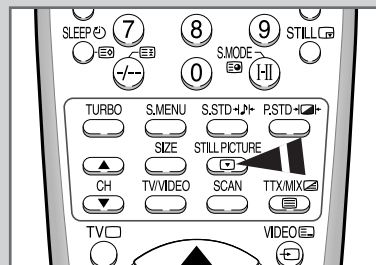

## Changing the Sound Standard (depending on the model)

You can select the type of special sound effect to be used when watching a given broadcast. The following sound effects are available in the order given:

- ◆ *Custom, Standard, Music, Movie, Speech.*

- 1 Press the **MENU** button.
- 2 Press the **▲** or **▼** button to select the "Sound" and press the **+** or **-** button.
- 3 Press the **+** or **-** button repeatedly to cycle through the five choices: **Custom, Standard, Music, Movie, Speech.**
- 4 When you are satisfied with the settings, press the **TV** button, or press the **MENU** button repeatedly to return to normal viewing.

You can use your remote control to select the type of special sound effect to be used when watching a given broadcast.

To select the required sound effect, simply press the **S.STD** (Sound standard) button on the remote control.

Result: The following sound effects are available in the order given:

**Custom ↔ Standard ↔ Music ↔ Movie ↔ Speech**



- You can display the sound adjust (or equalizer) menu directly by pressing the "S.MENU" (Sound menu) button on the remote control.

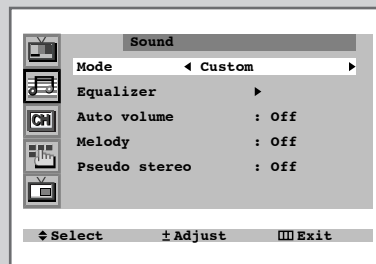
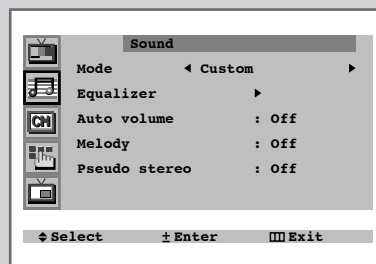

## Adjusting the Sound Settings

ENG

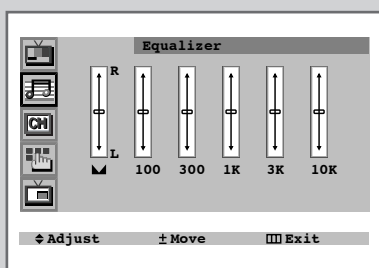
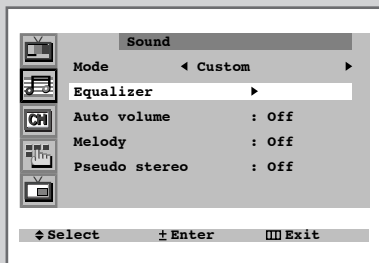

*The sound settings can be adjusted to suit your personal preferences.*

- 1 Press the **MENU** button.
- 2 Press the **▲** or **▼** button to select the "Sound" and press the **+** or **-** button.
- 3 Press the **▲** or **▼** button to select the "Equalizer".
  - When select the "Mode" to "Custom", the "Equalizer" menu is displayed.
- 4 Press the **+** or **-** button.

Result: The "Equalizer" menu is displayed.
- 5 Select the required option and adjust to satisfy your preference.
- 6 When you are satisfied with the settings, press the **TV** button, or press the **MENU** button repeatedly to return to normal viewing.



## Extra Sound Settings (depending on the model)

ENG

The following sound settings can be adjusted to suit your personal preferences.

### ◆ Auto volume

Each broadcasting station has its own signal conditions, and so it is not easy for you to adjust the volume every time the channel is changed. "Auto volume" lets you automatically adjust the volume of the desired channel by lowering the sound output when the modulation signal is high or by raising the sound output when the modulation signal is low.

### ◆ Melody

You can hear clear melody sound when the TV is powered ON or OFF.

### ◆ Pseudo stereo / Virtual surround

"Pseudo stereo" converts a monaural sound signal into two identical left and right channels. Once the "Pseudo stereo" or "Virtual surround" is set to "On" or "Off", the setting applies to the sound effects such as Standard, Music, Movie and Speech.

- 1 Press the **MENU** button.
- 2 Press the **▲** or **▼** button to select the "Sound" and press the **+** or **-** button.
- 3
 

To...	Press the...
Change an option	<b>▲</b> or <b>▼</b> button.
Select the required option (On/Off)	<b>+</b> or <b>-</b> button.
- 4 When you are satisfied with the settings, press the **TV** button, or press the **MENU** button repeatedly to return to normal viewing.

➤ Manufactured under license from Dolby Laboratories. "Dolby" and the double-D symbol  are trademarks of Dolby Laboratories.

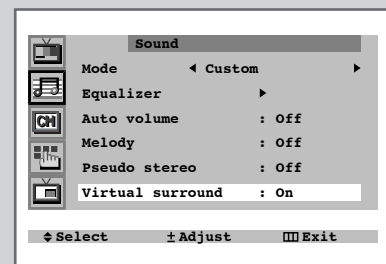
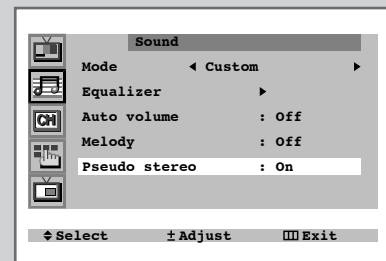
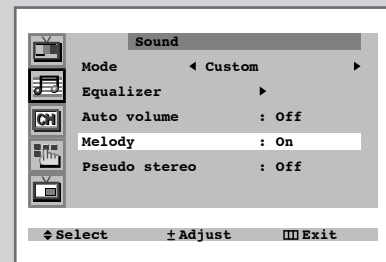
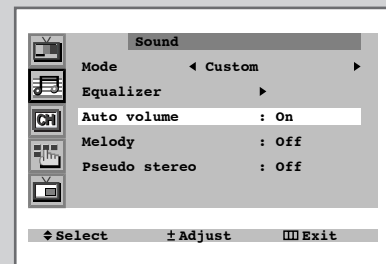
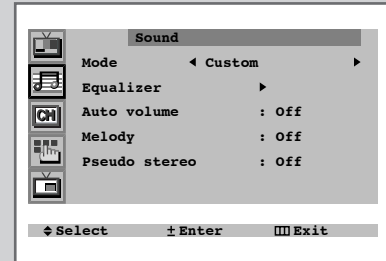

## Selecting the Sound Mode (depending on the model)

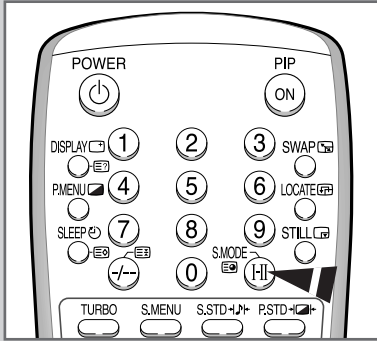

The "S.MODE" button displays/controls the processing and output of the audio signal. When power is switched ON, the mode is automatically preset to either "Dual-I" or "Stereo", depending on the current transmission.

	Type of broadcast	On-screen indication
<b>NICAM Stereo</b>	Regular broadcast (Standard audio)	<b>Mono</b> (Normal use)
	Regular + NICAM Mono	<b>Mono</b> ↔ <b>Mono Nicam</b> (Normal)
	NICAM Stereo	<b>Stereo</b> ↔ <b>Mono Nicam</b> (Normal)
	NICAM Dual-I/II	<b>Dual-I</b> → <b>Dual-II</b> → <b>Mono Nicam</b> (Normal) ↑—————↑
<b>A2 Stereo</b>	Regular broadcast (Standard audio)	<b>Mono</b> (Normal use)
	Bilingual or Dual-I/II	<b>Dual-I</b> ↔ <b>Dual-II</b>
	Stereo	<b>Stereo</b> ↔ <b>Mono</b> (Forced Mono)

- ◆ If the receiving conditions deteriorate, listening will be easier if the mode is set to the "Mono" position using the "S.MODE" button.
- ◆ If the stereo signal is weak (or if intermittent Stereo-Mono) and automatic switching occurs, then switch to the "Mono" mode.
- ◆ When receiving mono sound in the AV mode, connect to the "L" input jack on the panels. If the mono sound comes out only from the left speaker, then press the "S.MODE" button.

## Selecting the Turbo Sound (depending on the model)



*Turbo sound suitably emphasizes both higher and lower bands of sound (and includes other effects).*

To enjoy more magnificent and dynamic sound when watching music, movie or other channel, simply press the **TURBO** button on the remote control.

Turbo sound : On

## Adjusting the Volume

- ◆ Press the **+** button to increase the volume (cursor moves to the right)
- ◆ Press the **-** button to decrease the volume (cursor moves to the left)

- The volume setting is retained:
- ◆ When you switch the television to standby mode
  - ◆ When you switch the television off using the "POWER" (ON/OFF) button on the front panel
  - ◆ If there is a power failure.

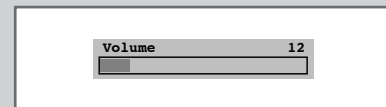
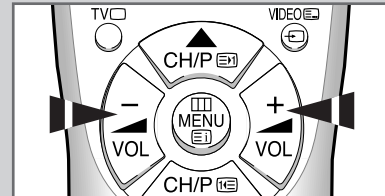

## Switching the Sound Off Temporarily

*You can switch the sound off temporarily, for example you may wish to answer the telephone.*

- 1 Press the **MUTE** button.  
**Result:** The sound is switched off and "M" is displayed.
- 2 When you wish to turn the sound back on at the same volume as before, press the **MUTE** button again (or either of the volume buttons).

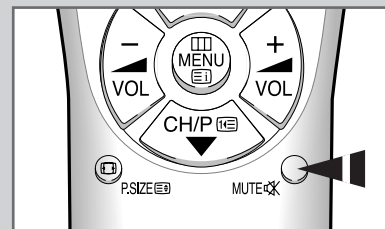

## Using the LNA (Low Noise Amplifier) Feature (Option)

*This feature is very useful in the situation that the TV is used in weak signal. LNA amplifies the TV signal in the weak signal area, but not noise.*

*This feature is working only weak signal condition, and that is memorized on current channel, additional.*

- 1 Press the **MENU** button.  
**Result:** The "Picture" menu is displayed.
- 2 Press the **+** or **-** button.
- 3 Press the **▲** or **▼** button to select the "LNA".
- 4 To select the "On" by pressing the **+** or **-** button.
- 5 When you have finished, press the **TV** button, or press the **MENU** button repeatedly to return to normal viewing.

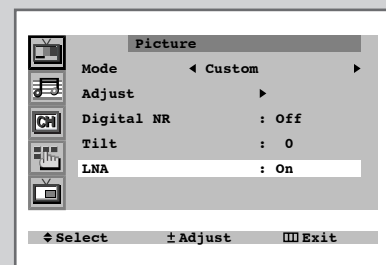

## Setting the Sleep Timer

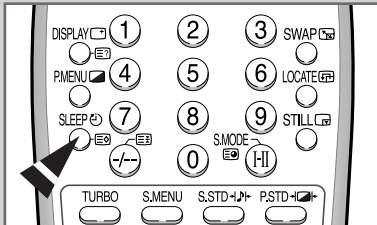

You can select a time period of between 30 and 180 minutes after which the television automatically switches to Standby mode by pressing the "SLEEP" button.

- 1 Press the **SLEEP** button on the remote control.

Result:

If the sleep timer is...	The screen displays...
Already set	Time remaining before the television will be placed in standby mode.
Not yet set	Word "Off".

- 2 Press the **SLEEP** button repeatedly and cycle through the preset time intervals (30, 60, 90, 120, 150, 180).

Result: The television automatically switches to standby mode when the timer reaches 0.

- 3 To cancel the sleep timer function, press the **SLEEP** button repeatedly and select "Off".

## Setting and Displaying the Current Time

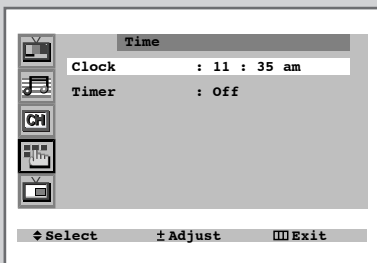
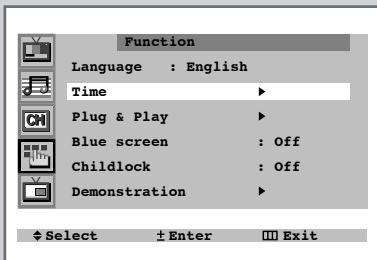

You can set the television's clock so that the current time is displayed when you press the "DISPLAY" button.

You must also set the time if you wish to use the automatic On/Off timers.

- The clock will be re-set when pressing the "POWER" (ON/OFF) button on the front panel.

- 1 Press the **MENU** button.
- 2 Press the **▲** or **▼** button to select the "Function" and press the **-** or **+** button.
- 3 Press the **▲** or **▼** button to select the "Time", and press the **-** or **+** button.  
Result: The "Time" menu is displayed with the "Clock" selected.
- 4
 

To...	Press the...
Move to the hour or minute	<b>-</b> or <b>+</b> button.
Set the hour or minute	<b>▲</b> or <b>▼</b> button.
- 5 When you have finished, press the **TV** button, or press the **MENU** button repeatedly to return to normal viewing.
- 6
 

To display the...	Press the DISPLAY button...
Channel information	Once.
Current time	Twice.
- 7 To remove the display, press the **DISPLAY** button again.

## Switching the Television On and Off Automatically

ENG

You can set the On/Off timers so that the television will:

- ◆ Switch on automatically and tune to the channel of your choice at the time you select
  - ◆ Switch off automatically at the time you select
- The first step is to set the television's clock (refer to "Setting and Displaying the Current Time" on the previous page). If you have not yet set the clock, the message "Set the clock first" is displayed.

- 1 Press the **MENU** button.
- 2 Press the ▲ or ▼ button to select the "Function" and press the – or + button.
- 3 Press the ▲ or ▼ button to select the "Time", and press the – or + button.

Result: The "Time" menu is displayed.

- 4 Press the ▲ or ▼ button to select the "Timer".
- 5 Press the – or + button to set the mode to "On".

Result: The "On time" and "Off time" options are displayed.

- 6 Press the ▲ or ▼ button to select the "On time".
- 7 Set the time at which you wish the television to be switched On.

To...	Press the...
Move to the hour or minute	– or + button.
Adjust the hour or minute	▲ or ▼ button.

- 8 In the same way, set the time at which you wish the television to be switched Off.

- 9 When you have finished setting the On/Off time, press the **TV** button, or press the **MENU** button repeatedly to return to normal viewing.

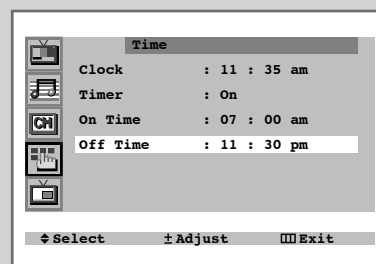
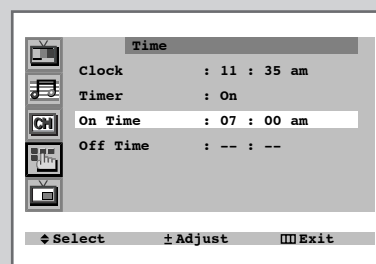
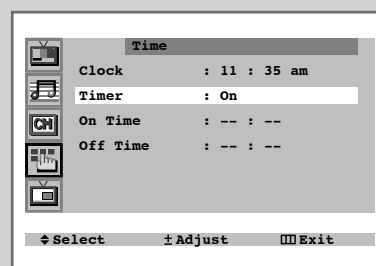
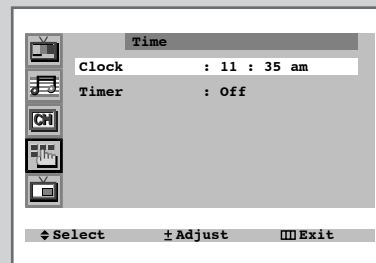

## Setting the Blue Screen Mode

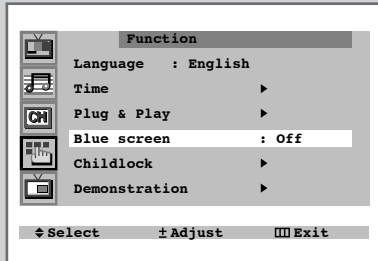

If no signal is being received or the signal is very weak, a blue screen automatically replaces the noisy picture background.

If you wish to continue viewing the poor picture, you must set the "Blue screen" mode to "Off".

- 1 Press the **MENU** button.
- 2 Press the **▲** or **▼** button to select the "Function" and press the **-** or **+** button.
- 3 Press the **▲** or **▼** button to select the "Blue screen".
- 4 Press the **-** or **+** button to select the required option (On/Off).
- 5 When you have finished, press the **TV** button, or press the **MENU** button repeatedly to return to normal viewing.

## Activating the Childlock

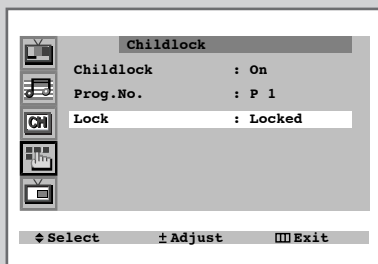
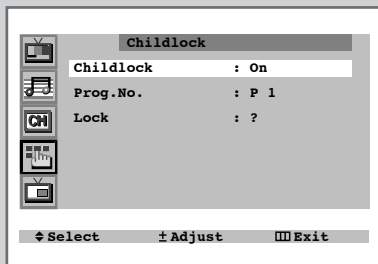
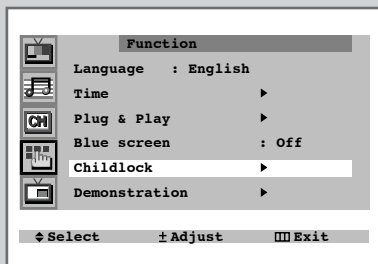

You can restrict viewing by locking the channels of your choice.

*Example:* You can prevent your children from watching unsuitable programmes.

- 1 Press the **MENU** button.
- 2 Press the **▲** or **▼** button to select the "Function" and press the **-** or **+** button.
- 3 Press the **▲** or **▼** button to select the "Childlock" and press the **-** or **+** button.
- 4 Set to "On" by pressing the **-** or **+** button.
  - If you want to unlock a channel, set to "Off".
- 5 Press the **▲** or **▼** button to select the "Prog.No.". Select the number of the channel to be locked by pressing the **-** or **+** button.
- 6 Press the **▲** or **▼** button to select the "Lock" and press the **-** or **+** button.
 

Result: "Locked" is displayed.
- 7 When you have finished, press the **TV** button, or press the **MENU** button repeatedly to return to normal viewing.

➤ If any channel is locked, you cannot enter the "Channel" menu (the message "Not available" is displayed).

## Picture In Picture (depending on the model)

ENG

You can display a "Picture-In-Picture screen" within the main picture of TV program or Video input. In this way you can watch or monitor TV program or the Video input from any connected equipment while watching TV or other Video input. For information about connection of other equipment, see pages 36~37.

- 1 Press the **MENU** button.
- 2 Press the **▲** or **▼** button to select the "PIP".
- 3 Set to "PIP : On" by pressing the **-** or **+** button.
- 4 Press the **▲** or **▼** button to select the "Select" and press the **-** or **+** button repeatedly.  
**Result:** You can assign a source of sub picture:  
**TV / AV1 / AV2 / S-Video**
- 5 Press the **▲** or **▼** button to select the "Prog.No.".
- 6 Select the channel that you want to view through sub picture by pressing the **-** or **+** button.
- 7 Press the **▲** or **▼** button to select the "Size" and press the **-** or **+** button repeatedly.  
**Result:** You can select the type of sub picture (depending on the model):
  - ◆ Large / Small
  - ◆ Large / Small / 3-PIP / 4-PIP / 9-PIP
  - ◆ Large / Small / Double screen1 / Double screen2 / 3-PIP / 4-PIP / 9-PIP
- 8 When you have finished, press the **TV** button, or press the **MENU** button repeatedly to return to normal viewing.

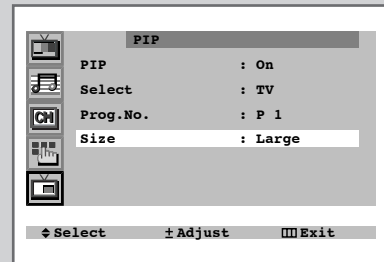
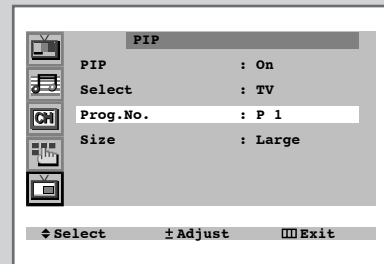
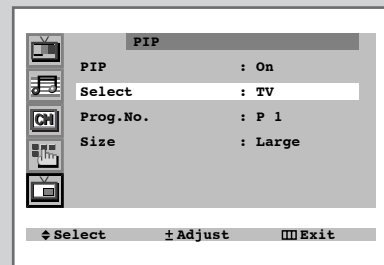
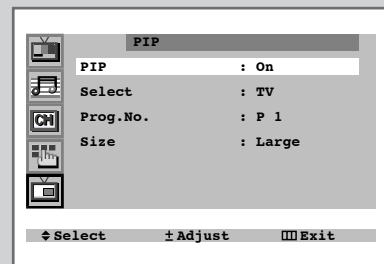
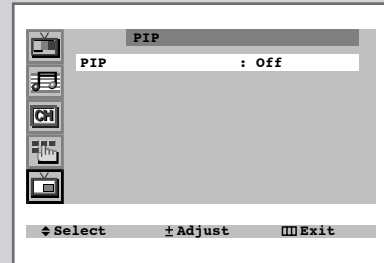

## Picture In Picture (depending on the model)

ENG

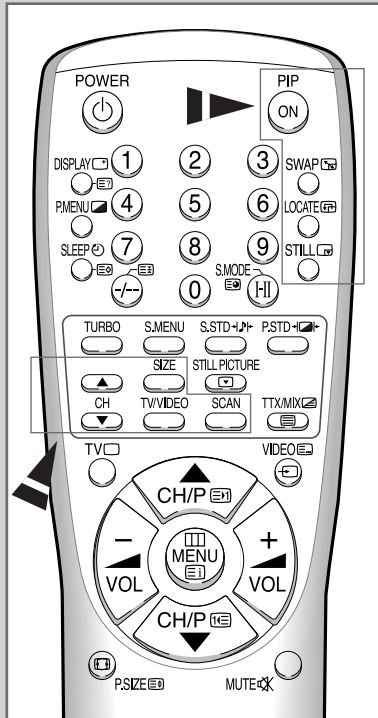

### Remote-control functions while "PIP" is "On":

Features	Description
<b>PIP ON</b>	Used to operate ON/OFF function of PIP directly.
<b>SWAP</b>	Used to interchange the main picture and the sub picture. ➤ When the main picture is in the Video mode and the sub picture is in the TV mode, you might not hear the sound of main picture when pressing the <b>SWAP</b> button after changing the sub picture channel. At this time, reselect the main picture channel.
<b>LOCATE</b>	Used to move the sub picture counterclockwise.
<b>STILL</b>	Used to freeze the sub picture.
<b>CH ▼/▲</b>	Used to select the channel of sub picture.
<b>SIZE</b>	Used to select the type of sub picture.
<b>TV/VIDEO</b>	Used to assign a source of sub picture ( <b>TV, AV1, AV2, S-Video</b> ).
<b>SCAN</b>	Used to scan every memorized channel in order. To stop scanning, press it again.



## Teletext Decoder

ENG

Most television channels carry "teletext," pages of written information that provide information such as:

- ◆ Television programme times
- ◆ News bulletins
- ◆ Weather forecasts
- ◆ Sports results
- ◆ Subtitles for the hard of hearing

The teletext pages are organized according to six categories:

Part	Contents
A	Selected page number.
B	Broadcasting station identity.
C	Current page number or search status
D	Date and time.
E	Text.
F	Status information.

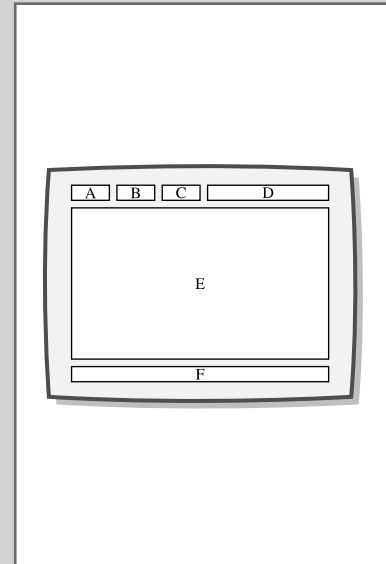

## Displaying Teletext Information

You can display teletext information at any time, but signal reception must be good. Otherwise:

- ◆ Information may be missing
- ◆ Some pages may not be displayed

To activate the teletext mode and display the contents page:

- 1 Using the ▲ ( ) or ▼ ( ) button, select the channel providing the teletext service.
- 2 Press the **TTX/MIX** button to activate the teletext mode.  
**Result:** The contents page (page 100) is displayed. It can be redisplayed at any time by pressing the **INDEX** ( ) button.
- 3 To display the actual broadcast simultaneously with the teletext page, press the **TTX/MIX** button.
- 4 To return to normal viewing press the **TV** button.

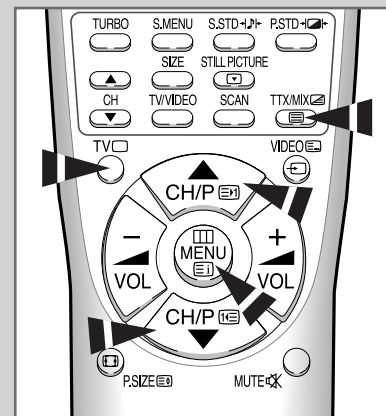

## Selecting a Specific Teletext Page

ENG

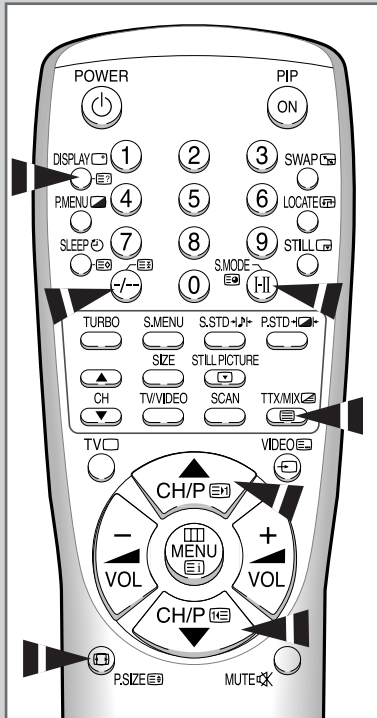

Press the number buttons on the remote control to enter the page number directly:

- 1 Enter the three-digit page number listed in the contents by pressing the corresponding numeric buttons.

**Result:** The current page counter is incremented and the page is then displayed.

- 2 If the selected page is linked with several secondary pages, the secondary pages are displayed in sequence. To freeze the display on a given page, press the HOLD (⏸). Press the HOLD again to resume.

- 3 Using the various display options:

To display...	Press the...
◆ Both teletext information and the normal broadcast	<b>TTX/MIX</b>
◆ Hidden text (answers to quiz games, for example)	REVEAL (⏏)
◆ The normal screen	REVEAL (⏏) again
◆ A secondary page, by entering its 4-digit number	SUB-PAGE (⏏)
◆ The next page	PAGE UP (⏏)
◆ The previous page	PAGE DOWN (⏏)
◆ Double-size letters in the: <ul style="list-style-type: none"> <li>• Upper half of the screen</li> <li>• Lower half of the screen</li> </ul>	SIZE (⏏) <ul style="list-style-type: none"> <li>◆ Once</li> <li>◆ Twice</li> </ul>
◆ Normal screen	◆ Three times

## Using FLOF to Select a Teletext Page

The various topics included in the teletext pages are color-coded, and can be selected by pressing the colored buttons on the remote control.

- 1 Display the teletext contents page by pressing the **TTX/MIX** button.
- 2 Press the colored button corresponding to the topic that you wish to select (The available topics are listed on the status information line).

**Result:** The page is displayed with additional color-coded information that can be selected in the same way.

- | 3 | To display the: | Press the:    |
|---|-----------------|---------------|
|   | Previous page   | Red button.   |
|   | Next page       | Green button. |
- 4 When you have finished, press the **TV** button to return to the normal broadcast.

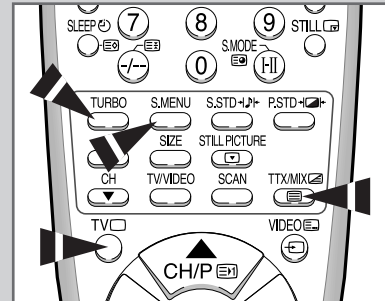

## Storing Teletext Pages

Up to four teletext pages can be stored.

- 1 Select the LIST mode.
 

**Result:** Four 3-digit numbers are displayed in different colors at the bottom of the screen.
- 2 Press the colored button corresponding to the page that will be replaced.
- 3 Enter the new page number using the numeric buttons.
- 4 Repeat steps 2 and 3 for each page to be stored, using a different colored button each time.
- 5 Press the STORE (E3) button until the corresponding blocks are displayed in white.

- The LIST (E3) button is used to switch between:
- ◆ LIST mode
  - ◆ FLOF mode

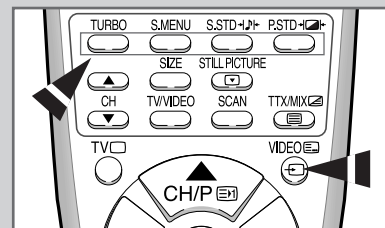

## Connecting to the AV-1 or 2 Input/Outputs

➤ These figures show typical connector-jack panels. The actual configuration on your TV may be different, depending on your model.

➤ AV-1 is used for equipment with an RGB output, such as video game devices and video disc players or a VCR.

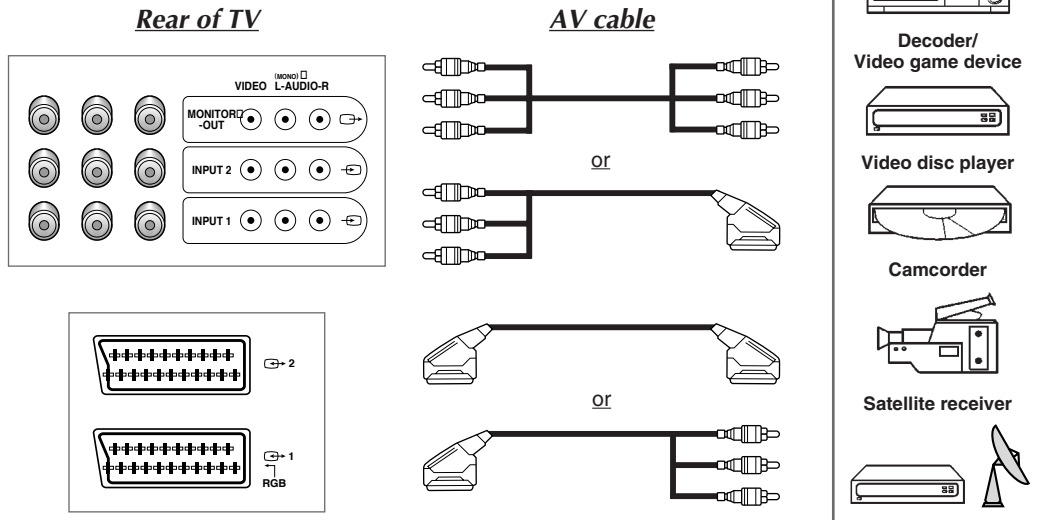

## Connecting to the S-VIDEO Input (depending on the model)

➤ The S-VIDEO/RCA (AUDIO-L and R) connectors are used for equipment with an S-Video output, such as a camcorder or VCR.

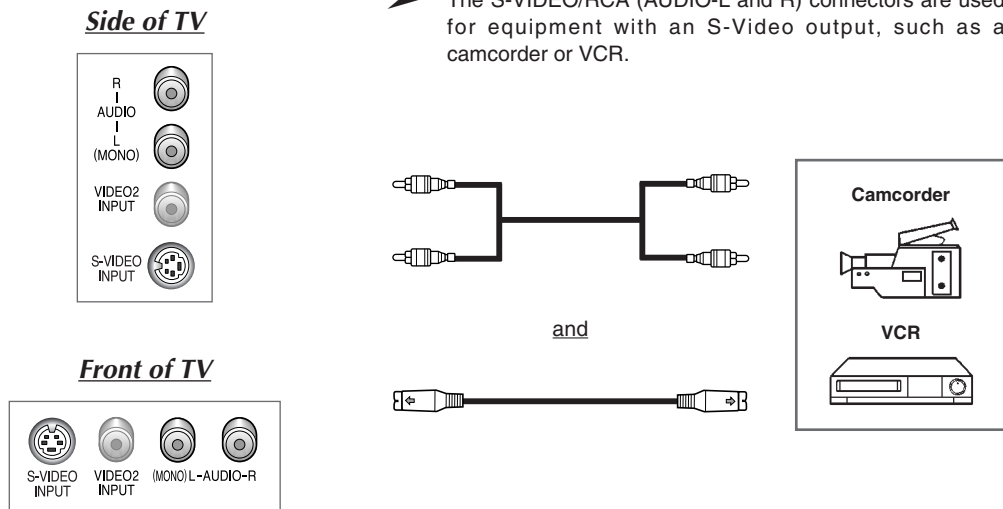

## Connecting to the DVD Input (Option)

- The DVD/RCA (AUDIO-L and R) connectors are used for equipment with a DVD output.

### Rear of TV

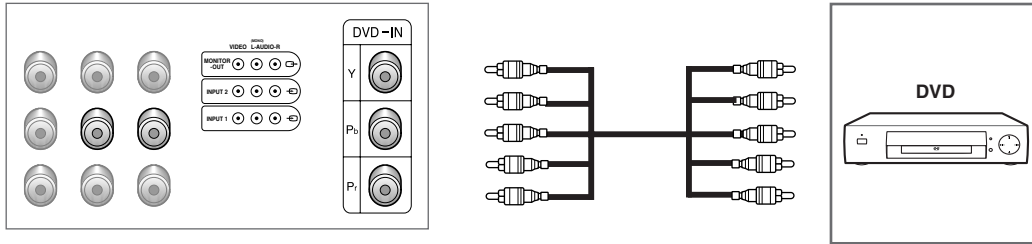

## Connecting to the RCA Input (depending on the model)

- The RCA (VIDEO + AUDIO-L and R) connectors are used for equipment such as camcorders, video disc players and some video game devices.

### Side of TV

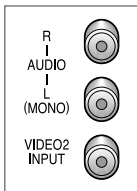

### Front of TV

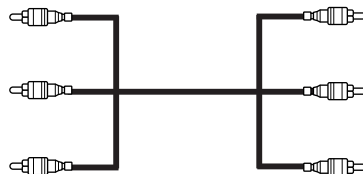
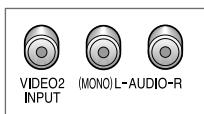

### Camcorder

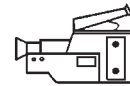

### Video disc player



### Decoder/ Video game device

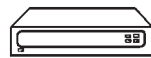

## Connecting Headphones

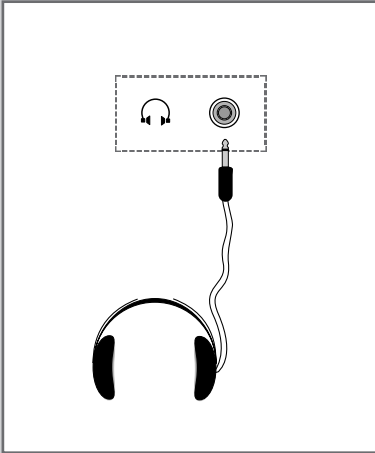

*You can connect a set of headphones to your television if you wish to watch a television programme without disturbing the other people in the room.*

- 1 Plug a set of headphones into the 3.5 mm mini-jack socket of the television.

**Result:** The sound is heard through the headphones.

- 2 When you wish to hear the sound through the speakers again, simply disconnect the headphones.

➤ Prolonged use of headphones at a high volume may damage your hearing.

## Viewing Pictures From External Sources

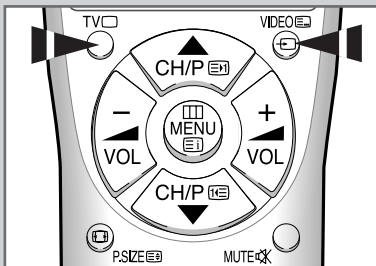

*Once you have connected up your various audio and video systems, you can view the different sources by selecting the appropriate input.*

- 1 Check that all the necessary connections have been made.
- 2 Switch the television on and if necessary, press the **VIDEO** button one or more times until the required input is displayed.

➤ Depending on the source selected, the pictures may appear automatically.

➤ To watch television programmes again, press the **TV** button and select the number of the channel required.

## Automatic Degaussing to Remove Colour Patches

A degaussing coil is mounted around the picture tube, so you do not normally need to degauss the television manually.

If you move the television to a different position and color patches appear on the screen, you must:

- ◆ Switch the television off by pressing the “POWER ⏻” (ON/OFF) button on the front panel
- ◆ Unplug the television from the wall socket
- ◆ Leave the television power-off (stand-by) for about 30 minutes so that the automatic degauss function can be activated, and then press the POWER ⏻ button on the remote control.

 If your television will be left unattended, press the “POWER ⏻” (ON/OFF) button to turn your television off.

## Troubleshooting: Before Contacting Service Personnel

Before contacting Samsung after-sales service, perform the following simple checks.

If you cannot solve the problem using the instructions below, note the model and serial number of the television and contact your local dealer.

No sound or picture	<ul style="list-style-type: none"> <li>◆ Check that the mains lead has been connected to a wall socket.</li> <li>◆ Check that you have pressed the “POWER ⏻” (ON/OFF) button.</li> <li>◆ Check the picture contrast and brightness settings.</li> <li>◆ Check the volume.</li> </ul>
Normal picture but no sound	<ul style="list-style-type: none"> <li>◆ Check the volume.</li> <li>◆ Check whether the <b>MUTE</b>  button has been pressed on the remote control.</li> </ul>
No picture or black and white picture	<ul style="list-style-type: none"> <li>◆ Adjust the colour settings.</li> <li>◆ Check that the broadcast system selected is correct.</li> </ul>
Sound and picture interference	<ul style="list-style-type: none"> <li>◆ Try to identify the electrical appliance that is affecting the television and move it further away.</li> <li>◆ Plug your television into a different mains socket.</li> </ul>
Blurred or snowy picture, distorted sound	<ul style="list-style-type: none"> <li>◆ Check the direction, location and connections of your aerial. This interference is often due to the use of an indoor aerial.</li> </ul>
Remote control malfunctions	<ul style="list-style-type: none"> <li>◆ Replace the remote control batteries.</li> <li>◆ Clean the upper edge of the remote control (transmission window).</li> <li>◆ Check the battery terminals.</li> </ul>

---

## **- AFTER SALES SERVICE**

---

- Do not hesitate to contact your retailer or service agent if a change in the performance of your product indicates that a faulty condition may be present.



AA68-01015D-03



## Free Manuals Download Website

<http://myh66.com>

<http://usermanuals.us>

<http://www.somanuals.com>

<http://www.4manuals.cc>

<http://www.manual-lib.com>

<http://www.404manual.com>

<http://www.luxmanual.com>

<http://aubethermostatmanual.com>

Golf course search by state

<http://golfingnear.com>

Email search by domain

<http://emailbydomain.com>

Auto manuals search

<http://auto.somanuals.com>

TV manuals search

<http://tv.somanuals.com>