



TXM3297HF / TXM3097WHF
TXM2797HF / TXM2796HF
TXM3296HF / TXM3298HF
TXM3098WHF / TXM2798HF

COLOR TELEVISION



ELECTRONICS

Samsung Electronics America inc.
105 Challenger Road, Ridgefield Park, N.J. 07660

SERVICE DIVISION
TEL: 1-800-SAMSUNG (1-800-726-7864)
www.samsungsupport.com

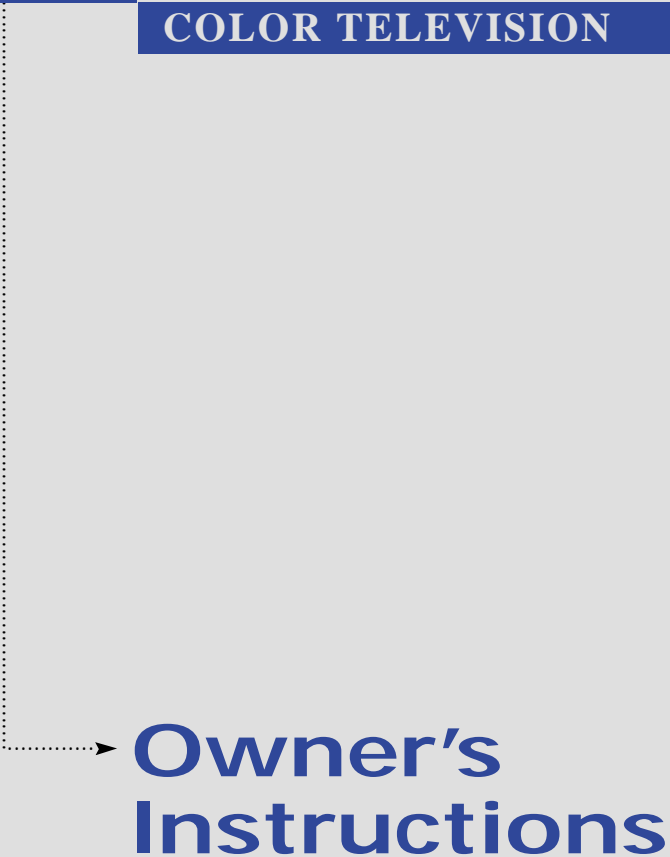

AA68-02395A(ENG)

Warning! Important Safety Instructions



CAUTION: TO REDUCE THE RISK OF ELECTRIC SHOCK, DO NOT REMOVE COVER (OR BACK). NO USER SERVICEABLE PARTS INSIDE. REFER SERVICING TO QUALIFIED SERVICE PERSONNEL.

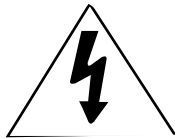

This symbol indicates high voltage is present inside. It is dangerous to make any kind of contact with any inside part of this product.



This symbol alerts you that important literature concerning operation and maintenance has been included with this product.

Note to CATV system installer: This reminder is provided to call CATV system installer's attention to Article 820-40 of the National Electrical Code (Section 54 of Canadian Electrical Code, Part I), that provides guidelines for proper grounding and, in particular, specifies that the cable ground shall be connected to the grounding system of the building as close to the point of cable entry as practical.

Caution: *FCC/CSA regulations state that any unauthorized changes or modifications to this equipment may void the user's authority to operate it.*

Caution: *To prevent electric shock, match the wide blade of plug to the wide slot, and fully insert the plug.*

Attention: *pour eviter les chocs electriques, introduire la lame le plus large de la fiche dans la borne correspondante de la prise et pousser jusqu'au fond.*

Important: One Federal Court has held that unauthorized recording of copyrighted TV programs is an infringement of U.S. copyright laws. Certain Canadian programs may also be copyrighted and any unauthorized recording in whole or in part may be in violation of these rights.

To prevent damage which may result in fire or electric shock hazard, do not expose this appliance to rain or moisture.

As an ENERGY STAR Partner,
Samsung Electronics America, Inc. has determined that this product or product model meets the ENERGY STAR guidelines for energy efficiency.

Thank You for Choosing Samsung

Thank you for choosing Samsung! Your new Samsung TV represents the latest in television technology. We designed it with easy-to-use on-screen menus and closed captioning capabilities, making it one of the best products in its class. We are proud to offer you a product that will provide convenient, dependable service and enjoyment for years to come.

Important Safety Information

 Always be careful when using your TV receiver. To reduce the risk of fire, electrical shock, and other injuries, keep these safety precautions in mind when installing, using, and maintaining your machine.

- Read all safety and operating instructions before operating your TV.
- Keep the safety and operating instructions for future reference.
- Heed all warnings on the TV receiver and in the operating instructions.
- Follow all operating and use instructions.
- Unplug the TV receiver from the wall outlet before cleaning. Use a damp cloth; do not use liquid or aerosol cleaners.
- Never add any attachments and/or equipment without approval of the manufacturer. Such additions can increase the risk of fire, electric shock, or other personal injury.
- Do not use the TV receiver where contact with or immersion in water is a possibility, such as near bath tubs, sinks, washing machines, swimming pools, etc.
- Do not place the TV on an unstable cart, stand, tripod, bracket, or table where it can fall. A falling TV can cause serious injury to a child or adult, and serious damage to the appliance. Use only with a cart, stand, tripod, bracket, or table recommended by the manufacturer or sold with the TV. Follow the manufacturer's instructions when mounting the unit, and use a mounting accessory recommended by the manufacturer. Move the TV and cart with care. Quick stops, excessive force, and uneven surfaces can make the unit and cart unsteady and likely to overturn.
- Provide ventilation for the TV receiver. The unit is designed with slots in the cabinet for ventilation to protect it from overheating. Do not block these openings with any object, and do not place the TV receiver on a bed, sofa, rug, or other similar surface. Do not place it near a radiator or heat register. If you place the TV receiver on a rack or bookcase, ensure that there is adequate ventilation and that you've followed the manufacturer's instructions for mounting.
- Operate your TV receiver only from the type of power source indicated on the marking label. If you are not sure of the type of power supplied to your home, consult your appliance dealer or local power company.
- Use only a grounded or polarized outlet. For your safety, this TV is equipped with a polarized alternating current line plug having one blade wider than the other. This plug will fit into the power outlet only one way. If you are unable to insert the plug fully into the outlet, try reversing the plug. If the plug still does not fit, contact your electrician to replace your outlet.



- Protect the power cord. Power supply cords should be routed so that they won't be walked on or pinched by objects placed on or against them. Pay particular attention to cords at plugs, convenience receptacles, and the point where they exit from the unit.
- Unplug the TV from the wall outlet and disconnect the antenna or cable system during a lightning storm or when left unattended and unused for long periods of time. This will prevent damage to the unit due to lightning and power-line surges.
- Avoid overhead power lines. An outside antenna system should not be placed in the vicinity of overhead power lines or other electric light or power circuits or where it can fall into such power lines or circuits. When installing an outside antenna system, be extremely careful to keep from touching the power lines or circuits. Contact with such lines can be fatal.
- Do not overload the wall outlet or extension cords. Overloading can result in fire or electric shock.
- Do not insert anything through the openings in the unit, where they can touch dangerous voltage points or damage parts. Never spill liquid of any kind on the TV.

- Ground outdoor antennas. If an outside antenna or cable system is connected to the TV, be sure the antenna or cable system is grounded so as to provide some protection against voltage surges and built-up static charges. Section 810 of the National Electrical Code, ANSI/NFPA No. 70-1984, provides information about proper grounding of the mast and supporting structure, grounding of the lead-in wire to an antenna discharge unit, size of grounding conductors, location of antenna discharge unit, connection to grounding electrodes, and requirements for the grounding electrode.

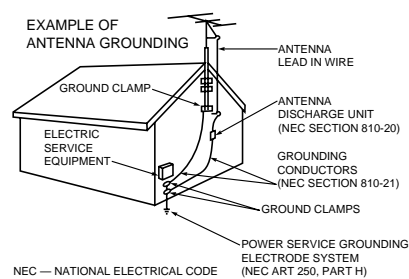

- Do not attempt to service the TV yourself. Refer all servicing to qualified service personnel. Unplug the unit from the wall outlet and refer servicing to qualified service personnel under the following conditions:
 - when the power-supply cord or plug is damaged
 - if liquid has been spilled on the unit or if objects have fallen into the unit
 - if the TV has been exposed to rain or water
 - if the TV does not operate normally by following the operating instructions
 - if the TV has been dropped or the cabinet has been damaged
 - when the TV exhibits a distinct change in performance
- If you make adjustments yourself, adjust only those controls that are covered by the operating instructions. Adjusting other controls may result in damage and will often require extensive work by a qualified technician to restore the TV to normal.
- When replacement parts are required, be sure the service technician uses replacement parts specified by the manufacturer or those that have the same characteristics as the original part. Unauthorized substitutions may result in additional damage to the unit.
- Upon completion of any service or repairs to this TV, ask the service technician to perform safety checks to determine that the TV is in a safe operating condition.

This device complies with part 15 of the FCC Rules. Operation is subject to the following two conditions:

- (1) This device may not cause harmful interference, and**
- (2) This device must accept any interference that may cause undesired operation.**

This television receiver provides display of television closed captioning in accordance with §15.119 of the FCC rules.

- 1) Read these instructions.
- 2) Keep these instructions.
- 3) Heed all warnings.
- 4) Follow all instructions.
- 5) Do not use this apparatus near water.
- 6) Clean only with dry cloth.
- 7) Do not block any ventilation openings, Install in accordance with the manufacturer's instructions.
- 8) Do not install near any heat sources such as radiators, heat registers, or other apparatus (including amplifiers) that produce heat.
- 9) Do not defeat the safety purpose of the polarized or grounding-type plug. A polarized plug has two blades with one wider than the other. A grounding type plug has two blades and a third grounding prong. The wide blade or the third prong are provided for your safety. If the provided plug does not fit into your outlet, consult an electrician for replacement of the obsolete outlet.
- 10) Protect the power cord from being from being walked on or pinched particularly at plugs, convenience receptacles, and the point where they exit from the apparatus.
- 11) Only use attachments/accessories specified by the manufacturer.
- 12) Use only with cart, stand, tripod, bracket, or table specified by the manufacturer, or sold with the apparatus. When a used, caution when moving the cart/apparatus combination to avoid injury from tip-over.
- 13) Unplug this apparatus. When a cart is used, use caution when moving the cart/apparatus combination to avoid injury from tip-over.
- 14) Refer all servicing to qualified service personnel. Servicing is required when the apparatus has been damaged in any way, such as power-supply cord or plug is damaged, liquid has been spilled or objects have fallen into the apparatus, the apparatus has been exposed to rain or moisture, does not operate normally, or has been dropped.



DOUBLE INSULATED - When servicing use only identical replacement parts.

CONTENTS

Chapter 1: Your New TV 1.1

List of Features	1.1
Familiarizing Yourself with The TV	1.2
Front Panel Buttons	1.2
Front Panel Jacks	1.3
Rear Panel Jacks	1.4
Remote Control	1.5

Chapter 2: Installation 2.1

Connecting VHF and UHF Antennas	2.1
Antennas with 300-ohm Flat Twin Leads	2.1
Antennas with 75-ohm Round Leads	2.2
Separate VHF and UHF Antennas	2.2
Connecting Cable TV	2.2
Cable without a Cable Box	2.2
Connecting to a Cable Box that Descrambles All Channels	2.3
Connecting to a Cable Box that Descrambles some Channels	2.3
Connecting a VCR	2.4
Connecting an S-VHS VCR	2.6
Connecting a Second VCR to Record from the TV	2.7
Connecting a DVD Player	2.7
Connecting a Camcorder	2.8
Installing Batteries in the Remote Control	2.9

Chapter 3: Operation 3.1

Turning the TV On and Off	3.1
Plug & Play Feature	3.1
Viewing the Menus and On-Screen Displays	3.3
Viewing the Menus	3.3
Viewing the Display	3.3
Selecting a Menu Language	3.4
Memorizing the Channels	3.5
Selecting the Video Signal-source	3.5
Storing Channels in Memory (Automatic Method)	3.6
Adding and Erasing Channels (Manual Method)	3.7
Changing Channels	3.8
Using the Channel Buttons	3.8
Directly Accessing Channels	3.8
Using the PRE-CH Button to select the Previous Channel	3.8
Adjusting the Volume	3.8
Using Mute	3.8
Labeling the Channels	3.9
Setting the Clock	3.10
Option 1: Setting the Clock Manually	3.10
Option 2: Using the Local PBS Channel to Automatically Set the TV Clock	3.11
Customizing the Picture	3.13
Using Automatic Picture Settings	3.14
Customizing the Sound	3.15
Using Automatic Sound Settings	3.16
Setting The On/Off Melody	3.17
Viewing a VCR or Camcorder Tape	3.18

Chapter 4: Special Features	4.1
Customizing Your Remote Control	4.1
Setting Up Your Remote Control to Operate Your VCR.	4.1
Setting Up Your Remote Control to Operate Your Cable Box	4.3
Fine Tuning Channels.	4.4
Digital Noise Reduction	4.5
Changing the Screen Size	4.6
Using the R.Surf	4.7
Setting the On/Off Timer	4.8
Setting the Sleep Timer.	4.9
Sound Features.	4.10
Choosing a Multi-Channel Sound (MTS) Soundtrack.	4.10
Extra sound settings (Turbo Sound, Surround, or Auto Volume)	4.11
Viewing Closed Captions	4.12
Viewing Picture-in-Picture	4.13
Activation Picture-in-Picture	4.13
Selecting a Signal Source (External A/V) for PIP	4.13
Changing the Size of the PIP Window	4.13
Changing the Location (Rotating) the PIP Window	4.14
Swapping the Contents of the PIP image and Main image	4.14
Changing the PIP Channel	4.14
Using the V-Chip (Option)	4.15
Setting Up Your Personal ID Number (PIN)	4.15
How to Enable/Disable the V-Chip	4.16
How to Set up Restrictions Using the "TV guidelines"	4.16
How to Set up Restrictions using the MPAA Ratings: G, PG, PG-13, R, NC-17, X	4.18
How to Reset the TV after the V-Chip Blocks a Channel ("Emergency Escape")	4.19
Chapter 5: Troubleshooting	5.1
Identifying Problems	5.1
Appendix	A.1
Cleaning and Maintaining Your TV	A.1
Using Your TV in Another Country	A.1
Specifications	A.1

Chapter One

YOUR NEW TV

List of Features

Your TV was designed with the latest technology. This TV is a high-performance unit that includes the following special features:

- Full Flat Screen
- Easy-to-use remote control
- Easy-to-use on-screen menu system
- Automatic timer to turn the TV on and off
- Adjustable picture and sound settings that can be stored in the TV's memory
- Automatic channel tuning for up to 181 channels
- A special filter to reduce or eliminate reception problems
- Fine tuning control for the sharpest picture possible
- A built-in multi-channel sound decoder for stereo and bilingual listening
- Built-in, dual channel speakers
- A special sleep timer
- Headphone jack for private listening
- 16:9 letter box format available depending upon source
- Picture in Picture

Familiarizing Yourself with The TV

Front Panel Buttons

The buttons on the front panel control your TV's basic features, including the on-screen menu. To use the more advanced features, you must use the remote control.

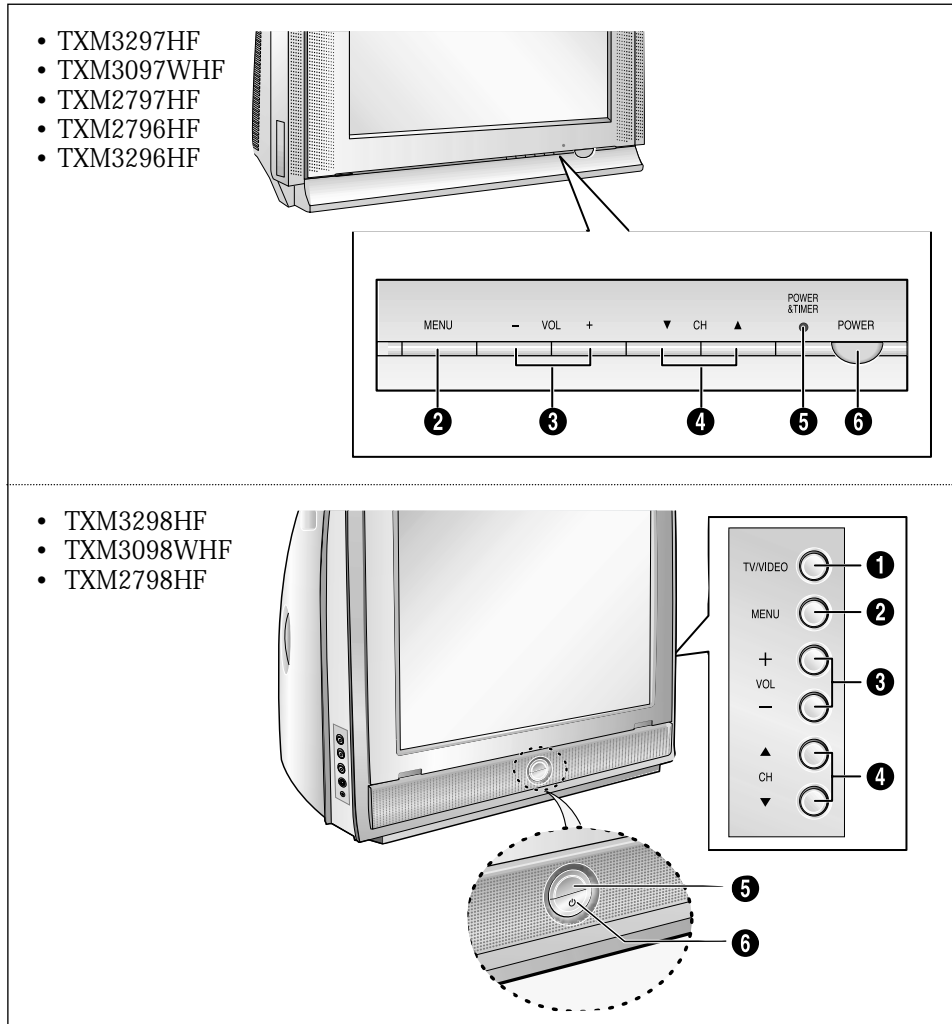

- TXM3297HF
- TXM3097WHF
- TXM2797HF
- TXM2796HF
- TXM3296HF

- TXM3298HF
- TXM3098WHF
- TXM2798HF

- 1 TV/VIDEO**
(TXM3298HF/TXM3098WHF/
TXM2798HF)
Press to change between viewing TV programs and signals from other components.
- 2 MENU**
Press to see an on-screen menu of your TV's features.
- 3 VOL - , +**
Press to increase or decrease the volume. Also used to select items on the on-screen menu.

- 4 CH ▼ and CH ▲**
Press to change channels. Also press to highlight various items on the on-screen menu.
- 5 POWER & TIMER indicator**
Lights up when you turn the power off.
- 6 POWER**
Press to turn the TV on and off.

YOUR NEW TV

Front Panel Jacks

You can use the front panel jacks to connect an A/V component that is used only occasionally, such as a camcorder or video game. (For information on connecting equipment, see pages 2.1 – 2.8.)

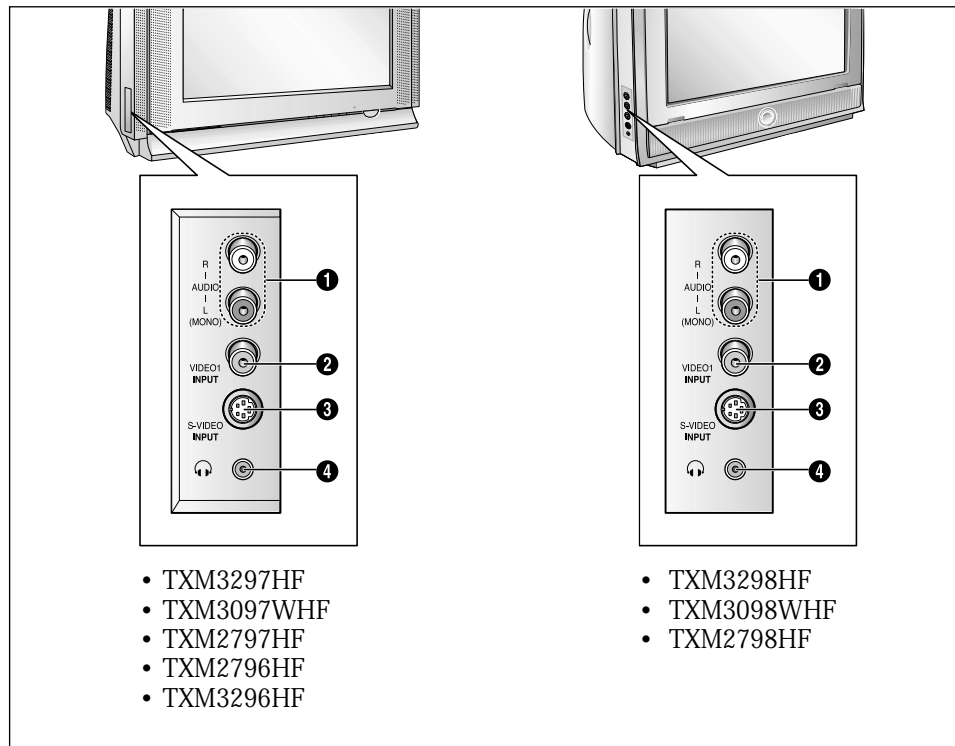

❶ AUDIO INPUT jacks

Used to connect the audio signals from a camcorder or video game.

❷ VIDEO INPUT jack

Used to connect a video signal from a camcorder or video game.

❸ SUPER VIDEO INPUT jack

S-Video signal from an S-VHS VCR or DVD player.

❹ HEADPHONE jack

Connect a set of external headphones to this jack for private listening.

YOUR NEW TV

Rear Panel Jacks

Use the rear panel jacks to connect an A/V component that will be connected continuously, such as a VCR or a DVD player. Because there are two sets of input jacks, you can connect two different A/V components (i.e., a VCR and a DVD, 2 VCRs, etc.)

For more information on connecting equipment, see pages 2.1 – 2.8.

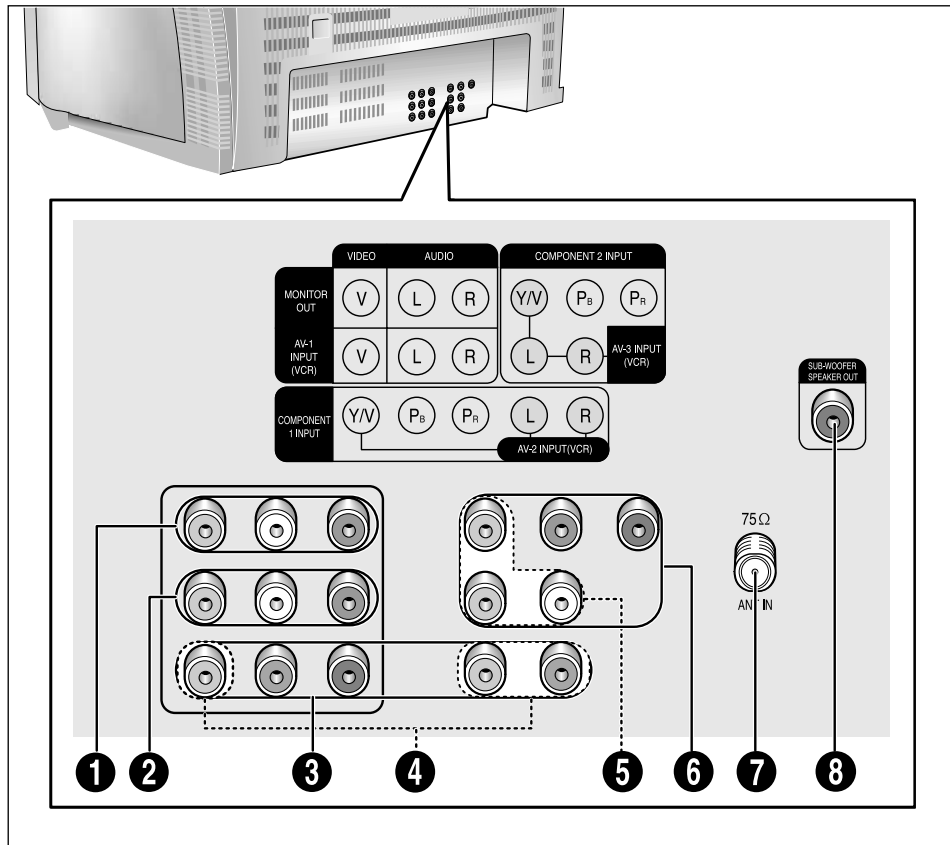

1 AUDIO-VIDEO MONITOR OUTPUT jacks

Connect to the audio/video input jacks of a recording VCR.

Note: The Monitor Out does not operate in Component 1 or 2 modes.

2, 4, 5 VIDEO INPUT jack

Video and Audio signals from VCRs, DVD players and similar devices.

Note: The common jack of component 1 and AV2, component 2 and AV3 input jacks are exclusive relation with each other.

3 COMPONENT 1 INPUT jacks (480i/480p/1080i)

Connect to the audio and component output jacks of a DVD player or Set-Top Box.

Note: Only black and white signals are output from a monitor in DVD/DTV mode.

6 COMPONENT 2 INPUT jacks (480i/480p/1080i)

Connect to the audio and component output jacks of a DVD player or Set-Top Box.

Note: Only black and white signals are output from a monitor in DVD/DTV mode.

7 VHF/UHF

Connect to an antenna or to a cable TV system.

8 SUB-WOOFER SPEAKER OUT (TXM3298HF/TXM3098WHF / TXM2798HF)

Connect to the Sub-woofer speaker jack (built in Sub-woofer cable).

YOUR NEW TV

Remote Control

You can use the remote control up to about 23 feet from the TV. When using the remote, always point it directly at the TV.

You can also use your remote control to operate your VCR and cable box. See page 4.1 for details.

1 POWER

Turns the TV on and off.

2 Number buttons

Press to select channels directly on the TV.

+100

Press to select channels over 100. For example, to select channel 121, press "+100," then press "2" and "1."

3 DISPLAY

Press to see the time, channel, etc., on-screen. Also press to exit (quit) the menu system.

4 P.SIZE

Press to change the screen size. Your choices are Normal screen, Zoom screen or Wide screen.

5 RESET

If your remote control is not functioning properly, take out the batteries and press the reset button for about 2-3 seconds. Re-insert the batteries and try using the remote control again.

6 MTS (Multichannel Television Stereo)

Press to choose stereo, mono or Separate Audio Program (SAP broadcast).

7 ADD/ERASE

Press to add or erase channels in the TV's memory.

8 TV/COMPONENT

Press to switch the TV or COMPONENT mode.

9 CH▲ and CH▼ (Channel Up/Down)

Press CH▲ or CH▼ to change channels. (Also used to highlight selections on the on-screen menus.)

10 MUTE

Press to temporarily cut off the sound.

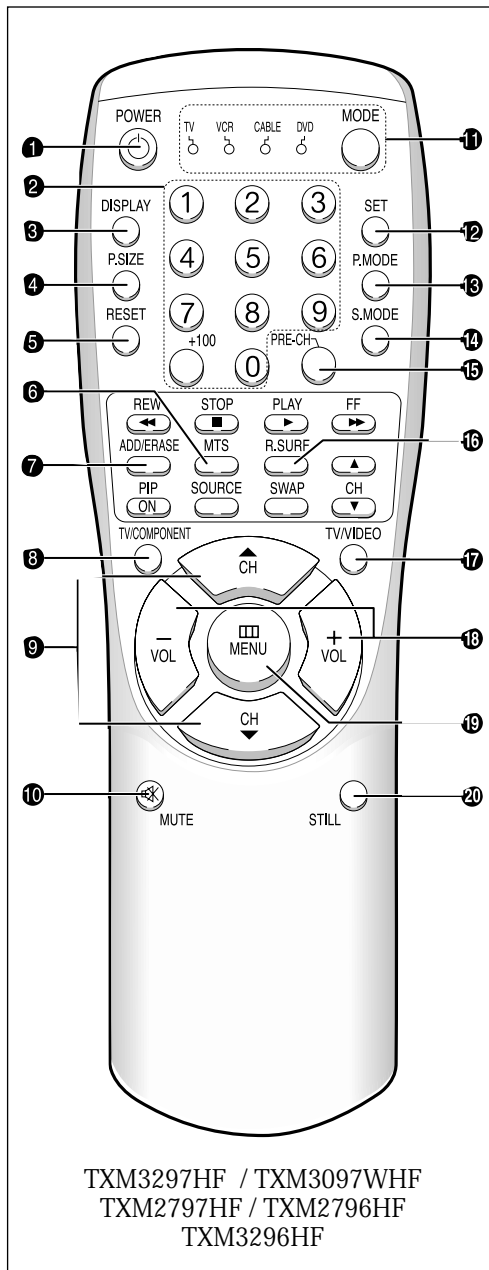

11 MODE

Selects a target device to be controlled by the Samsung remote control (i.e., TV, VCR, Cable box, or DVD).

12 SET

Use this button when you are setting up your remote control to operate your VCR, Cable box, or DVD).

13 P.MODE

Adjust the TV picture by selecting one of the preset factory settings (or select your personal, customized picture settings).

14 S.MODE

Adjust the TV sound by selecting one of the preset factory settings (or select your personal, customized sound settings).

15 PRE-CH

Tunes to the previous channel.

16 R.SURF

Press the R.SURF button to automatically return to a preferred channel after a user-preset time delay.

17 TV/VIDEO

Press to display all of the available video sources (i.e., Antenna/cable, VCR).

18 VOL -, VOL +

Press to increase or decrease the volume. (Also used to make selections on the on-screen menus.)

19 MENU

Displays the main on-screen menu.

20 STILL(Main)

Press to stop the action during a particular scene. Press again to resume normal video.

YOUR NEW TV

Remote Control

④ VCR Controls

REW (Rewind)

Press to rewind a tape in your VCR.

STOP

Press this button to stop a tape during play, record, rewind or fast forward. If the button is pressed during Full-Automatic play, the function will be cancelled.

PLAY

Press the PLAY button to play back prerecorded tapes.

F. F

Press to fast forward the tape in your VCR.

② PIP Controls

PIP

Press this button to control the PIP window.

SOURCE

Press to select one of the available signal sources for the PIP window.

SWAP

Exchanges the video signal that is currently displayed on the main screen with the signal in the PIP window.

CH

Displays the available channels in sequence. (These buttons change channels in the PIP window only).

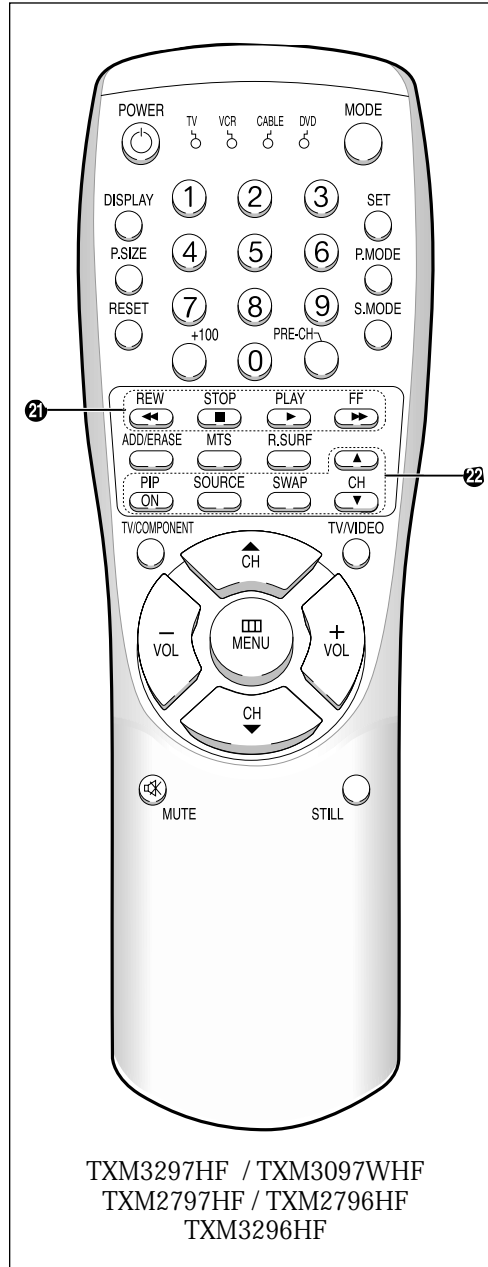

YOUR NEW TV

Remote Control

- 1 Power**
Turns the TV on and off.
- 2 Number buttons**
Press to select channels directly on the TV.

+100
Press to select channels over 100. For example, to select channel 121, press "+100," then press "2" and "1."
- 3 TV/Component**
Press to switch the TV or COMPONENT mode.
- 4 CH▲ and CH▼ (Channel Up/Down)**
Press CH▲ or CH▼ to change channels. (Also used to highlight selections on the on-screen menus.)

VOL -, VOL +
Press to increase or decrease the volume. (Also used to make selections on the on-screen menus.)
- 5 Mute**
Press to temporarily cut off the sound.
- 6 EQ.**
Press to select Equalizer menu directly.
- 7 P.size**
Press to change the screen size. Your choices are Normal screen, Zoom screen or Wide screen.
- 8 P.Mode**
Adjust the TV picture by selecting one of the preset factory settings (or select your personal, customized picture settings).
- 9 S.Mode**
Adjust the TV sound by selecting one of the preset factory settings (or select your personal, customized sound settings).

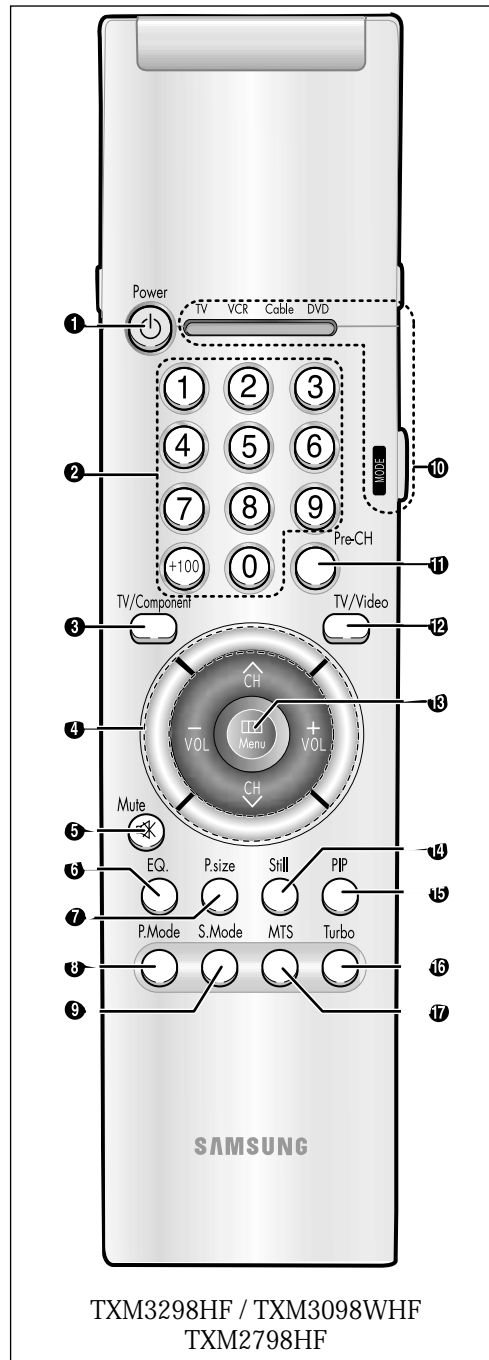

- 10 MODE**
Selects a target device to be controlled by the Samsung remote control (i.e., TV, VCR, Cable box, or DVD).
- 11 Pre-CH**
Tunes to the previous channel.
- 12 TV/Video**
Press to display all of the available video sources (i.e., Antenna/cable, VCR).
- 13 Menu**
Displays the main on-screen menu.
- 14 Still(Main)**
Press to stop the action during a particular scene. Press again to resume normal video.
- 15 PIP**
Press this button to control the PIP window.
- 16 Turbo**
Turbo sound emphasizes the bass and treble frequencies to add fullness to the sound.
- 17 MTS (Multichannel Television Stereo)**
Press to choose stereo, mono or Separate Audio Program (SAP broadcast).

YOUR NEW TV

Remote Control

18 Reset

If your remote control is not functioning properly, take out the batteries and press the reset button for about 2-3 seconds. Re-insert the batteries and try using the remote control again.

19 Display

Press to see the time, channel, etc., on-screen. Also press to exit (quit) the menu system.

20 Sleep

Press to select a preset time interval for automatic shutoff.

21 VCR Controls

Stop

Press this button to stop a tape during play, record, rewind or fast forward. If the button is pressed during Full-Automatic play, the function will be cancelled.

REW (Rewind)

Press to rewind a tape in your VCR.

Play/Pause

Press the Play/Pause button to play back prerecorded tapes or pause the tape.

FF

Press to fast forward the tape in your VCR.



TXM3298HF / TXM3098WHF
TXM2798HF

22 Set

Use this button when you are setting up your remote control to operate your VCR, Cable box, or DVD).

23 R.surf

Press the R.SURF button to automatically return to a preferred channel after a user-preset time delay.

24 Add/Erase

Press to add or erase channels in the TV's memory.

25 PIP Controls

Source

Press to select one of the available signal sources for the PIP window.

Still

Press to stop the action during a particular scene. Press again to resume normal video.

Locate

Press to move the PIP window to any of the four corners of the TV screen.

Swap

Exchanges the video signal that is currently displayed on the main screen with the signal in the PIP window.

Size

Press to make the PIP window small, large, double screen or stock ticker window.

CH

Displays the available channels in sequence. (These buttons change channels in the PIP window only).

Chapter Two

INSTALLATION

Connecting VHF and UHF Antennas

If your antenna has a set of leads that look like this, see "Antennas with 300-ohm Flat Twin Leads," below.



If your antenna has one lead that looks like this, see "Antennas with 75-ohm Round Leads," on page 2.2.



If you have two antennas, see "Separate VHF and UHF Antennas," on page 2.2.

Antennas with 300-ohm Flat Twin Leads

If you are using an off-air antenna (such as a roof antenna or "rabbit ears") that has 300-ohm twin flat leads, follow the directions below.

1

Place the wires from the twin leads under the screws on the 300-75 ohm adaptor (not supplied). Use a screwdriver to tighten the screws.

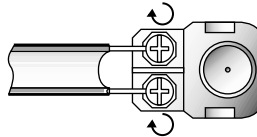

2

Plug the adaptor into the VHF/UHF terminal on the bottom of the back panel.

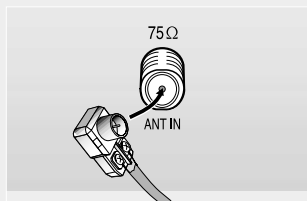

INSTALLATION

Antennas with 75-ohm Round Leads

1

Plug the antenna lead into the VHF/UHF terminal on the bottom of the back panel.

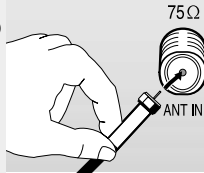

Separate VHF and UHF Antennas

If you have two separate antennas for your TV (one VHF and one UHF), you must combine the two antenna signals before connecting the antennas to the TV. This procedure requires an optional combiner-adaptor (available at most electronics shops).

1

Connect both antenna leads to the combiner.

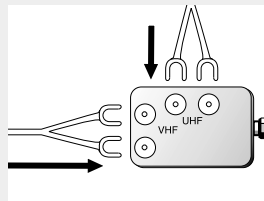

2

Plug the combiner into the VHF/UHF terminal on the bottom of the rear panel.

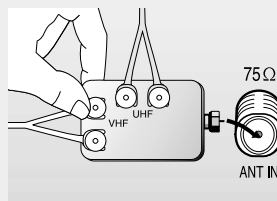

Connecting Cable TV

To connect to a cable TV system, follow the instructions below.

Cable without a Cable Box

1

Plug the incoming cable into the VHF/UHF antenna terminal on back of the TV.

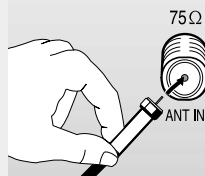

◀ Because this TV is cable-ready, you do not need a cable box to view unscrambled cable channels.

INSTALLATION

Connecting to a Cable Box that Descrambles All Channels

1

Find the cable that is connected to the ANTENNA OUT terminal on your cable box.

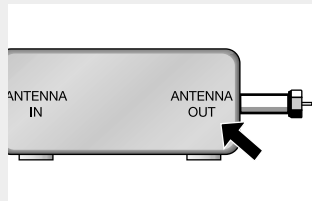

◀ This terminal might be labeled "ANT OUT," "VHF OUT," or simply, "OUT."

2

Connect the other end of this cable to the VHF/UHF antenna terminal on the back of the TV.

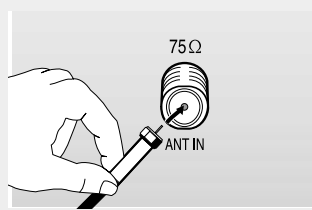

Connecting to a Cable Box that Descrambles Some Channels

If your cable box descrambles only some channels (such as premium channels), follow the instructions below. You will need a two-way splitter, an RF (A/B) switch, and four lengths of coaxial cable. (These items are available at most electronics stores.)

1

Find and disconnect the cable that is connected to the ANTENNA IN terminal on your cable box.

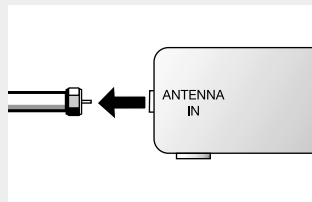

◀ This terminal might be labeled "ANT IN," "VHF IN," or simply, "IN."

2

Connect this cable to a two-way splitter.

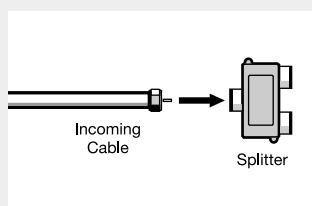

3

Connect a coaxial cable between an OUTPUT terminal on the splitter and the IN terminal on the cable box.

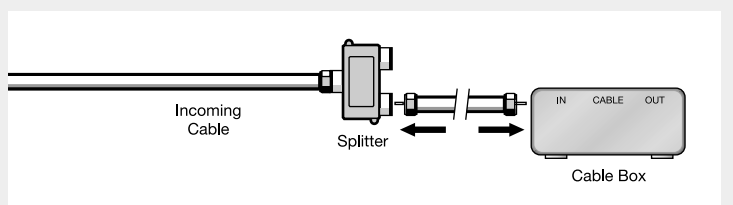

INSTALLATION

4

Connect a coaxial cable between the ANTENNA OUT terminal on the cable box and the B-IN terminal on the A/B switch.

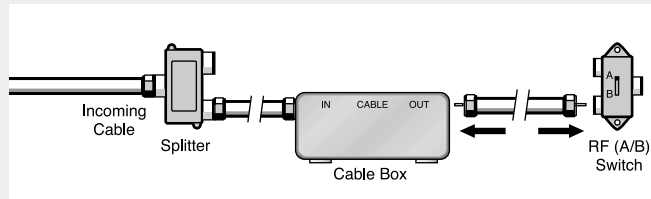

5

Connect another cable between the other OUT terminal on the splitter and the A-IN terminal on the RF (A/B) switch.

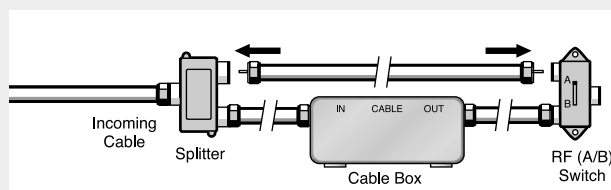

6

Connect the last coaxial cable between the OUT terminal on the RF (A/B) switch and the VHF/UHF terminal on the rear of the TV.

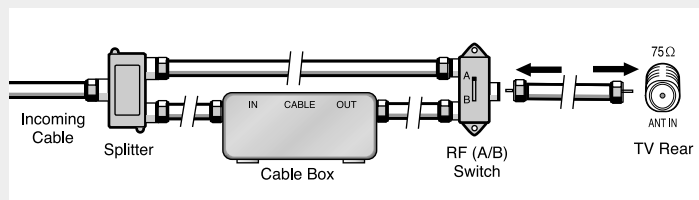

After you've made this connection, set the A/B switch to the "A" position for normal viewing. Set the A/B switch to the "B" position to view scrambled channels. (When you set the A/B switch to "B," you will need to tune your TV to the cable box's output channel, which is usually channel 3 or 4.)

INSTALLATION

Connecting a VCR

These instructions assume that you have already connected your TV to an antenna or a cable TV system (according to the instructions on pages 2.1-2.3). Skip step 1 if you have not yet connected to an antenna or a cable system.

- 1**
Unplug the cable or antenna from the back of the TV.

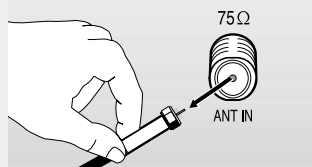

- 2**
Connect the cable or antenna to the ANTENNA IN terminal on the back of the VCR.

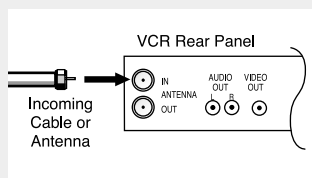

- 3**
Connect a coaxial cable between the ANTENNA OUT terminal on the VCR and the antenna terminal on the TV.

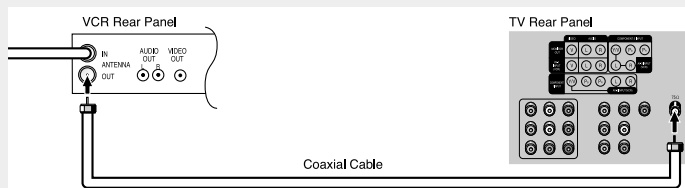

A coaxial cable is usually included with a VCR. (If not, check your local electronics store).

- 4**
Connect a set of audio cables between the AUDIO OUT jacks on the VCR and the AUDIO jacks (AV1-AV3) on the TV.

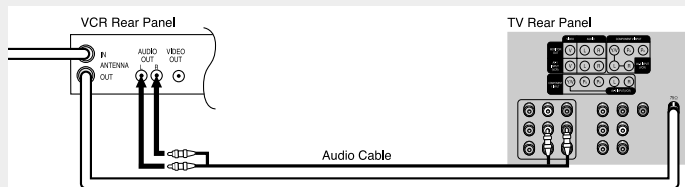

If you have a "mono" (non-stereo) VCR, use the Y-connector (not supplied) to hook up to the left and right audio input jacks of the TV. If your VCR is stereo, you must connect two cables.

- 5**
Connect a video cable between the VIDEO OUT jack on the VCR and the VIDEO jack (AV1-AV3) on the TV.

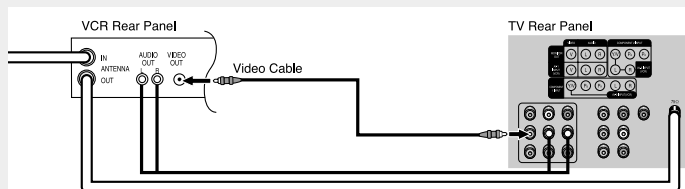

Follow the instructions in "Viewing a VCR or Camcorder Tape" to view your VCR tape.

INSTALLATION

Connecting an S-VHS VCR

Your TV can be connected to an S-Video signal from an S-VHS VCR.
(This connection delivers a better picture as compared to a standard VHS VCR.)

1

To begin, follow steps 1–3 in the previous section to connect the antenna or cable to your VCR and your TV.

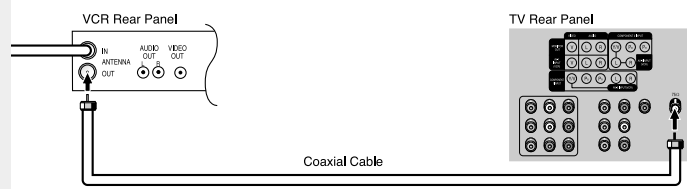

2

Connect a set of audio cables between the AUDIO OUT jacks on the VCR and the AUDIO INPUT 1 jacks on the TV.

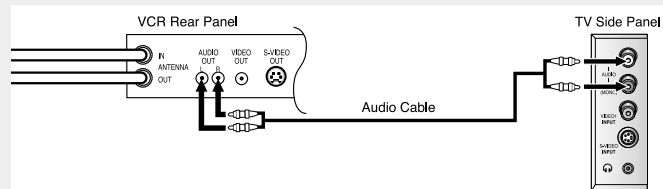

Make sure the jacks you are using are underneath the number "1."

3

Connect an S-video cable between the S-VIDEO OUT jack on the VCR and the S-VIDEO INPUT jack on the TV.

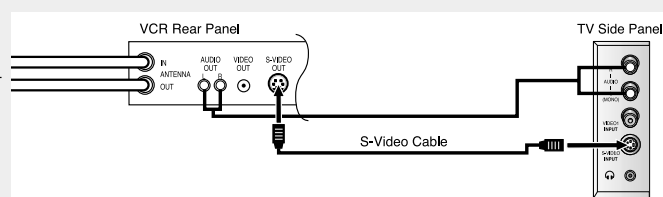

An S-video cable is usually included with an S-VHS VCR. (If not, check your local electronics store.)

INSTALLATION

Connecting a Second VCR to Record from the TV

Your TV can send out signals of its picture and sound to be recorded by a second VCR. To do this, connect your second VCR as follows:

1

Connect a set of audio cables between the AUDIO OUT jacks on the TV and the AUDIO IN jacks on the VCR.

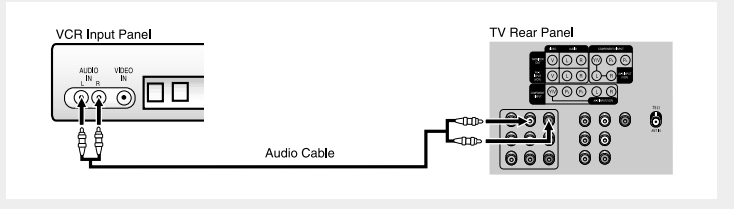

(The VCR input jacks might be either on the front or on back of the VCR.)

2

Connect a video cable between the VIDEO OUT jack on the TV and the VIDEO IN jack on the VCR.

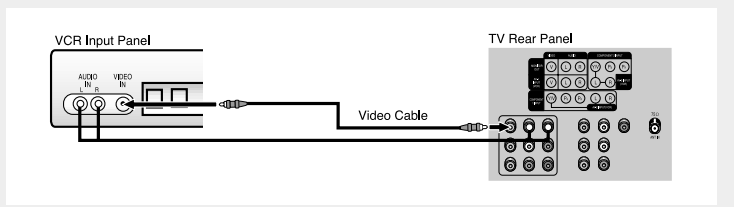

Refer to your VCR's instructions for more information about how to record using this kind of connection.

Connecting a DVD Player (480i/480p)

The rear panel jacks on your TV make it easy to connect a DVD player to your TV.

1

Connect a set of audio cables between the AV-2 INPUT(VCR) or AV-3 INPUT(VCR) jacks on the TV and the AUDIO OUT jacks on the DVD player.

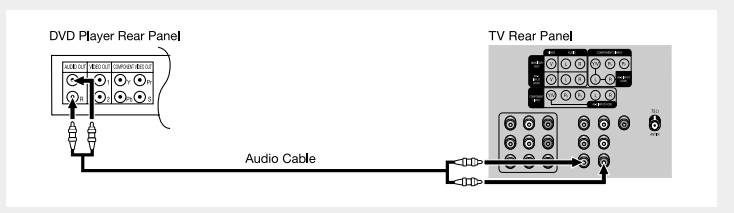

2

Connect a video cable between the COMPONENT 1 INPUT (Y/V, P_B, P_R) or COMPONENT 2 INPUT (Y/V, P_B, P_R) jacks on the TV and the DVD-OUT (Y, P_B, P_R) jacks on the DVD player.

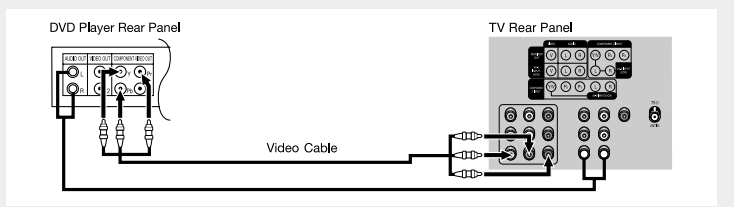

Note: For an explanation of Component video, see your DVD player's owner's manual.

INSTALLATION

Connecting a Digital TV Set-Top Box (480p/1080i)

Connect the Y, P_B, and P_R video outputs of the set-top box to their corresponding inputs on the TV. Next, connect the Left and Right audio from the set-top box to the corresponding L and R terminals on the TV. (The connections for a typical set-top box are shown below.)

1

Connect a coaxial cable between the ANTENNA OUT terminal on the Set Top Box and the antenna terminal on the TV.

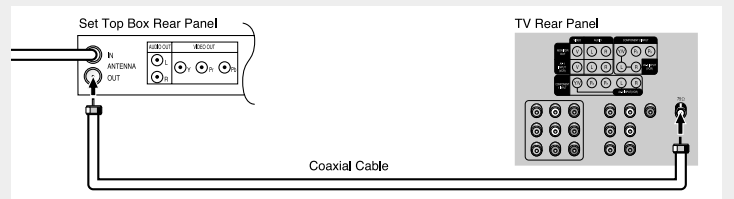

2

Connect a set of audio cables between the AV-3 INPUT(VCR) or AV-2 INPUT(VCR) jacks on the TV and the AUDIO OUT jacks on the Set Top Box.

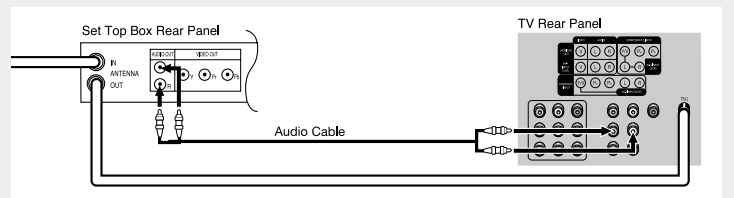

3

Connect a video cable between the COMPONENT 2 INPUT (Y/V, P_B, P_R) or COMPONENT 1 INPUT (Y/V, P_B, P_R) jacks on the TV and the VIDEO OUT (Y, P_B, P_R) jacks on the Set Top Box.

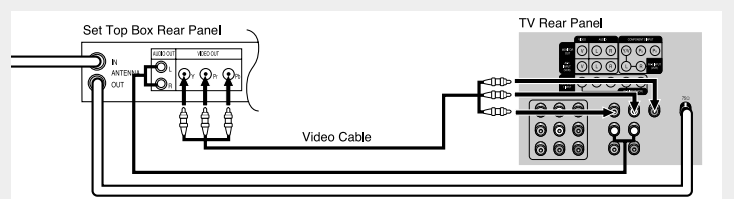

Note: For an explanation of Set top box, see your Set top box owner's manual.

INSTALLATION

Connecting a Camcorder

The side panel jacks on your TV make it easy to connect a camcorder to your TV. They allow you to view the camcorder tapes without using a VCR. (Also see “Viewing an External Signal Source” on page 3.17)

1

Locate the A/V output jacks on the camcorder. They are usually found on the side or back of the camcorder.

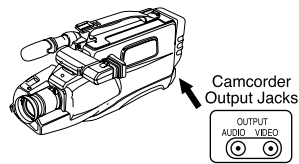

2

Connect an audio cable between the AUDIO OUTPUT jack on the camcorder and the AUDIO terminals on the TV.

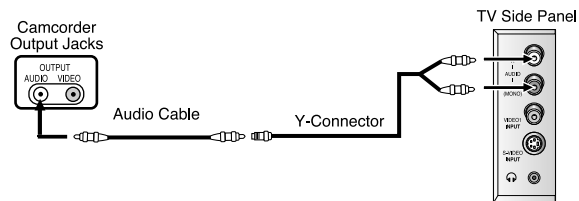

3

Connect a video cable between the VIDEO OUTPUT jack on the camcorder and the VIDEO terminal on the TV.

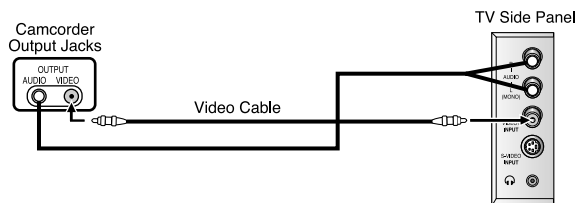

The audio-video cables shown here are usually included with a Camcorder. (If not, check your local electronics store.) If your camcorder is stereo, you need to connect a set of two cables.

INSTALLATION

Installing Batteries in the Remote Control

1

Slide the cover out completely.

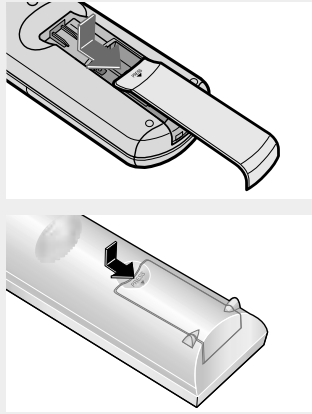

2

Install two AA size batteries.

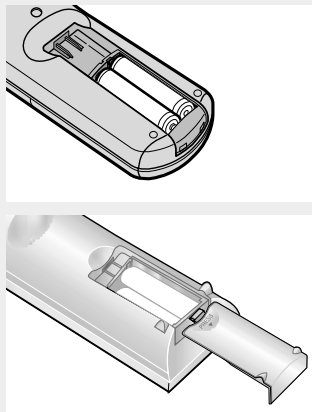

◀ Make sure to match the “+” and “-” ends of the batteries with the diagram inside the compartment.

3

Replace the cover.

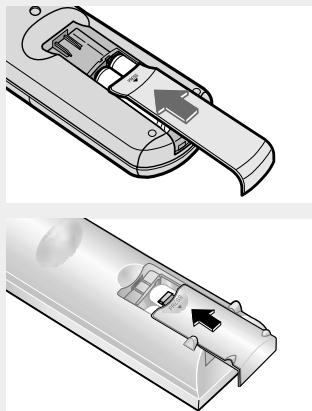

◀ Remove the batteries and store them in a cool, dry place if you won't be using the remote control for a long time.

The remote control can be used up to about 23 feet from the TV.

(Assuming typical TV usage, the batteries last for about one year.)

Chapter Three

OPERATION

Turning the TV On and Off

Press the **POWER** button on the remote control.
You can also use the **POWER** button on the front panel.

Plug & Play Feature

When the TV is initially powered On, five basic customer settings proceed automatically and subsequently: Setting the language, Video signal source, Ant. input check, Auto program, and Clock.

1

Press the **POWER** button on the remote control.

The message "Plug & Play" is displayed.
It flickers for a little while and then the "Language" menu is automatically displayed.

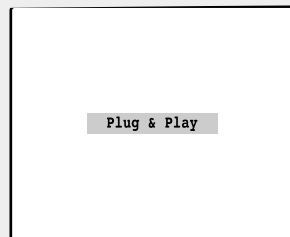

2

Press the **VOL+** or **VOL-** button to select the desired language.
Press the **MENU** button to enter the language, and then the "Channel" menu is automatically displayed.

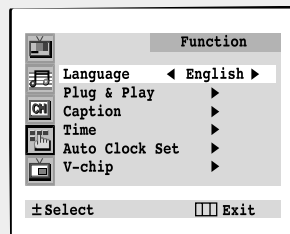

3

Press the **VOL+** or **VOL-** button to select the desired video signal source.
Press the **MENU** button to enter the video signal source, and then the "Ant Input check" is automatically displayed.

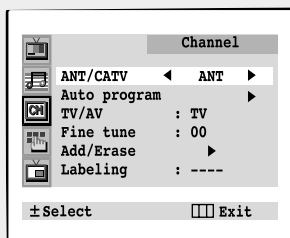

continued...

OPERATION

4

Make sure that the antenna is connected to the TV. And then press the **VOL+** or **VOL-** button to activate "Auto Program" or press the **MENU** button to skip. (refer to "Auto program" on page 3.6.)

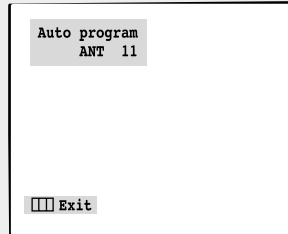

5

Press the **VOL+** or **VOL-** button to move to the hour or minute. Set the hour or minute by pressing the **CH▲** or **CH▼** button. (refer to "Setting the clock" on page 3.10.)

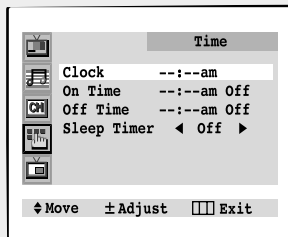

6

When you have finished, press the **MENU** button. The message "Enjoy your watching.." is displayed.

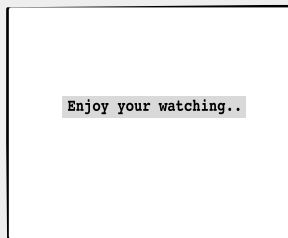

7

If you want to reset this feature

- (1) Press the **MENU** button.
- (2) Press the **CH▼** button three times to select the Function menu and press the **VOL+** button.
- (3) Press the **CH▼** button to select Plug & Play and press the **VOL+** button. The message "Plug & Play" is displayed.

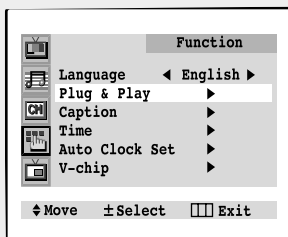

Note: Plug & Play feature doesn't work when the V-chip is on or when in the A/V mode.

Viewing the Menus and On-Screen Displays

Viewing the Menus

1

With the power on, press the **MENU** button.

The main menu appears on the screen. Its left side has five icons: Picture, Sound, Channel, Function and PIP.

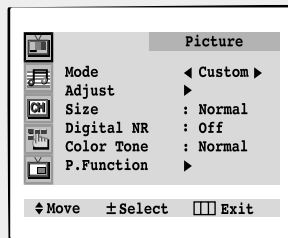

◀ The on-screen menus disappear from the screen after thirty seconds.

2

Use the **CH▲** and **CH▼** buttons to highlight one of the 5 icons. Then press the **VOL+** button to access the icon's sub-menu.

3

Press the **MENU** button to exit.

◀ You can also use the **MENU**, **CHANNEL**, and **VOLUME** buttons on the control panel of the TV to make selections.

Viewing the Display

The display identifies the current channel and the status of certain audio-video settings.

1

Press the **DISPLAY** button on the remote control.

The on-screen display shows any or all of the following: Active channel, the channel label, video source, the time, and the time remaining on the sleep timer.

("*" indicates a channel has been manually fine tuned.)

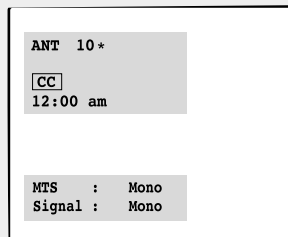

◀ The on-screen displays disappear after ten seconds.

OPERATION

Selecting a Menu Language

1

Press the **MENU** button to display the menu.

Press the **CH ▼** button to select "Function", then press the **VOL +** button

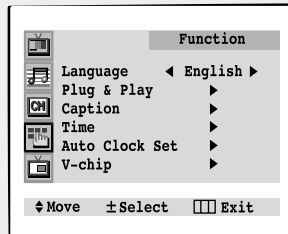

2

Press the **VOL +** button to select the appropriate language: English, Spanish, or French.

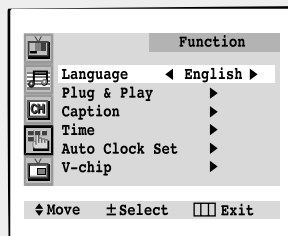

3

Press the **MENU** button to exit.

Memorizing the Channels

Your TV can memorize and store all of the available channels for both “off-air” (antenna) and cable channels. After the available channels are memorized, use the CH ▲ and CH ▼ buttons to scan through the channels. This eliminates the need to change channels by entering the channel digits. There are three steps for memorizing channels: selecting a broadcast source, memorizing the channels (automatic) and adding and deleting channels (manual).

Selecting the Video Signal-source

Before your television can begin memorizing the available channels, you must specify the type of signal source that is connected to the TV (i.e., an antenna or a cable system).

1

Press the **MENU** button to display the menu.

Press the **CH ▼** button to select “Channel”, then press the **VOL +** button

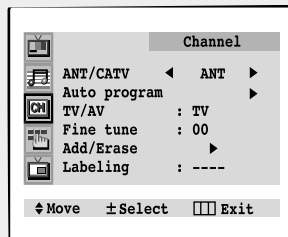

2

Repeatedly press the **VOL +** button to cycle through these choices: ANT (antenna) STD, HRC or IRC (all cable TV).

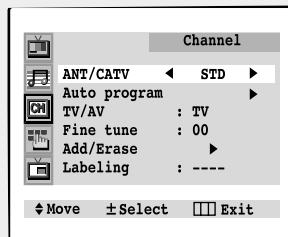

Note: STD, HRC and IRC identify various types of cable TV systems. Contact your local cable company to identify the type of cable system that exists in your particular area.

At this point the signal source has been selected. Proceed to “Storing Channels in Memory” (next page).

OPERATION

Storing Channels in Memory (Automatic Method)

1

First, select the correct signal source (ANT, STD, HRC, IRC). See steps 1~4 on previous page.

Press the **MENU** button to display the menu.

Press the **CH** ▼ button to select "Channel", then press the **VOL +** button.

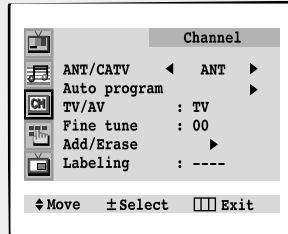

2

Press the **CH** ▼ button to select "Auto program".

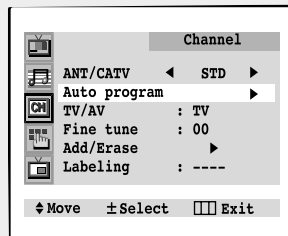

3

Press the **VOL +** button. The TV will begin memorizing all of the available channels.

After all the available channels are stored, the Auto program menu reappears. Press the **MENU** button to exit.

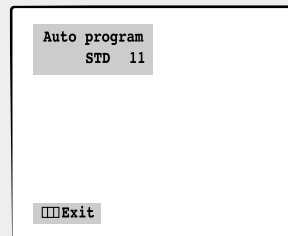

◀ The TV automatically cycles through all of the available channels and stores them in memory. This takes about one to two minutes.

Press **MENU** at any time to interrupt the memorization process and return to the Channel menu.

Note: Channel auto program does not function when the V-chip is active.

OPERATION

Adding and Erasing Channels (Manual Method)

1

Press the **MENU** button to display the menu.

Press the **CH ▼** button to select "Channel", then press the **VOL+** button.

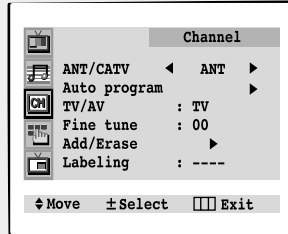

2

Press the **CH ▲** or **CH ▼** button to select "Add/Erase", then press the **VOL+** button.

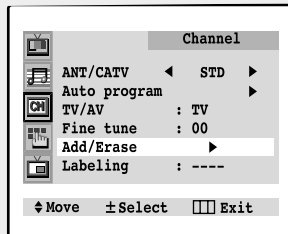

3

Press the **VOL+** button.

Press the **CH ▲/▼** button or the number buttons to select the channel you want to add or erase.

Press the **MENU** button.

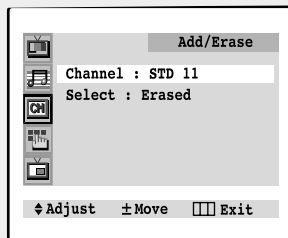

4

Press the **CH ▲** or **CH ▼** button to select "Select".

Press the **VOL+** or **VOL-** button to select "Added" or "Erased".

Press the **MENU** button to exit.

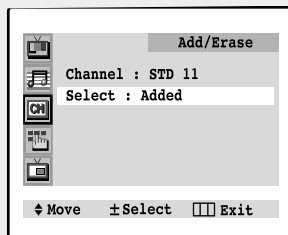

Changing Channels

Using the Channel Buttons

1

Press the **CH ▲** or **CH ▼** button to change channels.

When you press **CH ▲** or **CH ▼**, the TV changes channels in sequence. You will see all the channels that the TV has memorized. (The TV must have memorized at least three channels.) You will not see channels that were either erased or not memorized.

Directly Accessing Channels

Use the number buttons to quickly tune to any channel.

1

Press the number buttons to go directly to a channel.
For example, to select channel 27, press "2," then "7."
The TV will change channels when you press the second number.

When you use the number buttons, you can directly select channels that were either erased or not memorized.

To select a channel over 100, press the **+100** button.
(For channel 122, press "+100," then "2," then "2.")

To change to single-digit channels (0–9) faster, press "0" before the single digit.
(For channel "4," press "0," then "4.")

Using the PRE-CH Button to select the Previous Channel

1

Press the **PRE-CH** button.
The TV will switch to the last channel viewed.

◀ To quickly switch between two channels that are far apart, tune to one channel, then use the number button to select the second channel. Then, use the **PRE-CH** button to quickly alternate between them.

Adjusting the Volume

Press **VOL +** or **– VOL** to increase or decrease the volume.

Using Mute

At any time, you can temporarily cut off the sound using the Mute button.

1

Press **MUTE** and the sound cuts off.
The word "Mute" will appear in the lower-left corner of the screen.

2

To turn mute off, press **MUTE** again, or simply press either the **VOL –** or **VOL +** button.

OPERATION

Labeling the Channels

Use this feature to assign an easy-to-remember label to any channel (i.e., "CBS", "ESPN", "PBS2", "CNN1", etc.) A label consists of four fields, where each field is a letter, a number, "*", or a blank. When the DISPLAY button is pressed, the channel label will appear next to the channel number.

1

Press the **CH ▲** or **CH ▼** button to tune to the channel that will be labeled.

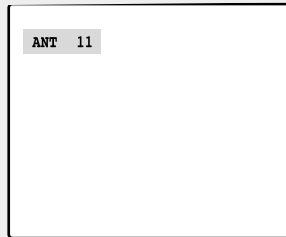

2

Press the **MENU** button to display the menu, then press the **CH ▼** button to select "Channel".

Press the **VOL +** button.

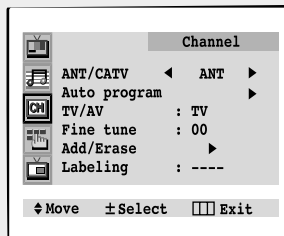

◀ Note: You cannot select "Labeling" in the A/V mode.

3

Press the **CH ▼** button to select "Labeling".

Press the **VOL +** button to begin labeling. The left-most field will be highlighted.

(Each label has four fields. See top paragraph.)

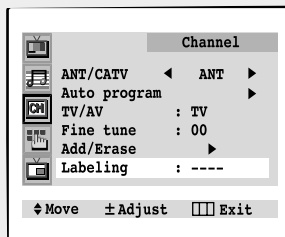

4

Press the **CH ▲** or **CH ▼** button to select a letter, a number, "*", or a blank. (Pressing the **CH ▲** button results in this sequence: A,B,...Z,*, blank,0,1,...9).

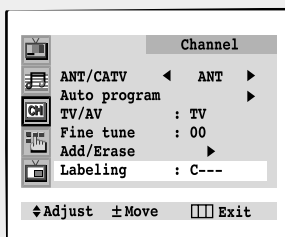

5

Press the **VOL+** button to switch to the next field, which will be highlighted. Select a second letter or digit using the **CH ▲** and **CH ▼** buttons, as above. Repeat the process to select the last two digits.

Press the **MENU** button to set the label and clear the menus from the screen.

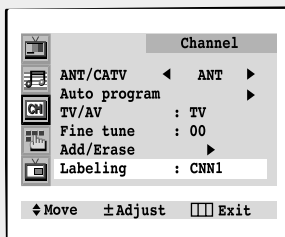

Setting the Clock

Setting the clock is necessary in order to use the various timer features of the TV. Also, you can check the time while watching the TV. (Just press the DISPLAY button.)

Option 1: Setting the Clock Manually

1

Press the **MENU** button to display the menu.

Press the **CH ▼** button to select "Function", then press the **VOL +** button.

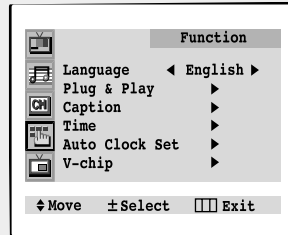

2

Press the **CH ▼** button to select "Time" menu.

Press the **VOL +** button: The Time menu will appear on the screen, and "Clock" will be highlighted.

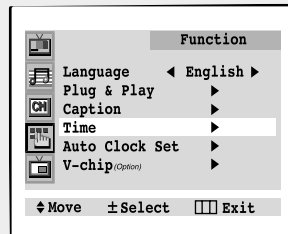

3

Press the **VOL +** button again (the hours digits will be highlighted). Press the **CH ▲** or **CH ▼** button repeatedly until the correct hour appears.

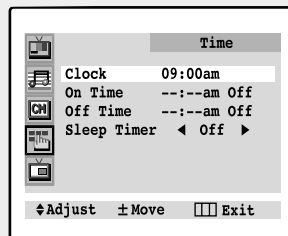

4

After the hour is entered, Press the **VOL +** button. (at this point the minutes digits will be highlighted). Press the **CH ▲** or **CH ▼** button to select the correct minutes.

After selecting the correct minutes, press the **VOL +** button.

Press the **MENU** button to exit.

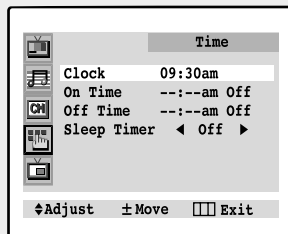

◀ When selecting the hours, be sure to select the proper time of day (AM or PM).

You can change the hours by pressing the **CH ▲** or **CH ▼** button repeatedly (or by holding down either of these buttons).

◀ The time will appear every time you press the DISPLAY button.

OPERATION

Option 2: Using the Local PBS Channel to Automatically Set the TV Clock

1

Press the **MENU** button to display the menu.

Press the **CH ▼** button to select "Function", then press the **VOL +** button.

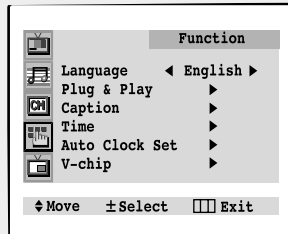

2

Press the **CH ▼** button to select "Auto clock set" menu, then press the **VOL +** button.

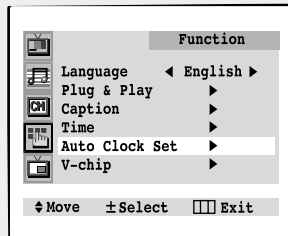

3

Press the **VOL +** button to select Auto clock set "On".

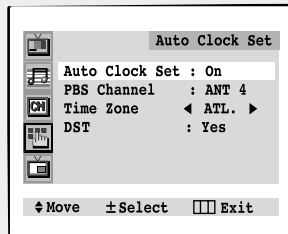

4

Press the **CH ▼** button to select "PBS channel". While "PBS channel" is selected, press the **VOL +** button to activate the channel-number field.

Press the **CH ▲** and **CH ▼** to select your local PBS channel.

Press the **MENU** button.

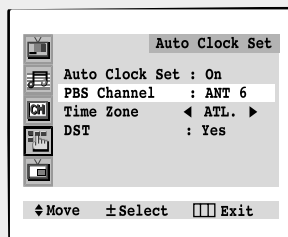

continued...

OPERATION

5

Press the **CH ▼** button to select "Time zone". While "Time zone" is selected, then press the **VOL+** or **VOL-** to change the Time zone.

Sequence: ATL., EAST, CEN., MTN., PAC., ALAS., HAW.

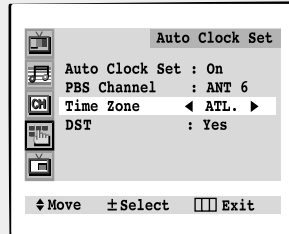

6

Press the **CH ▼** button to select "DST" (Daylight saving time). While "DST" is selected, press the **VOL+** or **VOL-** button to indicate "Yes" or "No". The clock is set. Press the **MENU** button to exit.

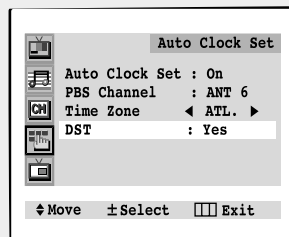

Customizing the Picture

You can use the on-screen menus to change the Contrast, Brightness, Sharpness, Color, Tint and according to personal preference. (Alternatively, you can use one of the “automatic” settings. See next page.)

1

Press the **MENU** button to display menu.

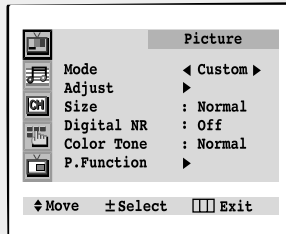

2

Press the **VOL -** or **VOL +** button repeatedly, until the word “Custom” is selected. (When Custom is highlighted, the words “Adjust” will appear on the screen.)

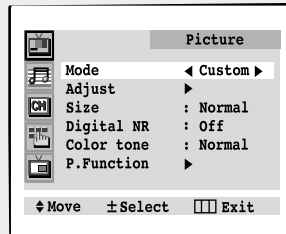

3

Press the **CH ▼** button to select “Adjust”, then press the **VOL+** button. (The words Contrast, Brightness, Sharpness, Color, and Tint will appear on the screen.) Press the **CH ▲** or **CH ▼** button to select a particular item.

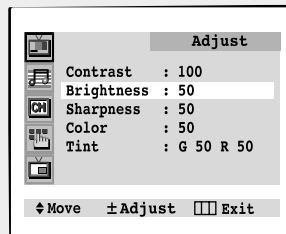

4

Press the **VOL -** or **VOL +** button to increase or decrease the value of a particular item. For example, if you select “Brightness,” pressing the **VOL +** button increases it.

Press the **MENU** button to exit.

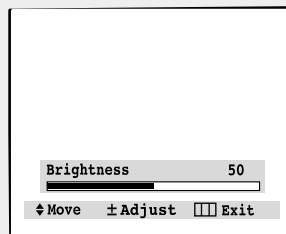

◀ After adjusting an item, the gauge will automatically disappear (after about 5 seconds).

Using Automatic Picture Settings

Your TV has three automatic picture settings (“Standard”, “Natural”, “Mild” and “Dynamic”) that are preset at the factory. You can activate either Standard, Natural, Mild or Dynamic by pressing the P.MODE button (or by making a selection from the menu). Or, you can select “Custom” which automatically recalls your personalized picture settings.

1

Press the **MENU** button to display the menu, then press the **VOL +** button.

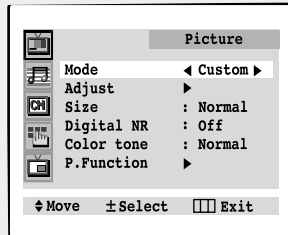

2

Press the **VOL -** or **VOL +** button to select the “Standard,” “Natural,” “Mild,” “Dynamic” or “Custom” picture setting.

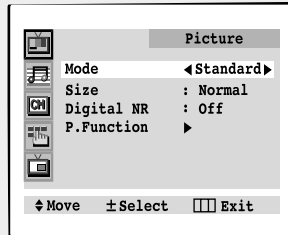

- Choose *Standard* for the standard factory settings.
- Natural: Optimal indoor screen condition.
- Choose *Mild* (“Mild Contrast”) when viewing the TV in low light, or when playing video games.
- Choose *Dynamic* for viewing the TV during the day or when there is bright-light in the room.
- Choose *Custom* if you want to adjust the settings according to personal preference (see “Customizing the Picture, page 3.13).

OPERATION

Customizing the Sound

The sound settings can be adjusted to suit your personal preferences.
(Alternatively, you can use one of the “automatic” settings. See next page.)

1

Press the **MENU** button to display the menu.

Press the **CH ▼** button to select the “Sound”, then press the **VOL +** button.

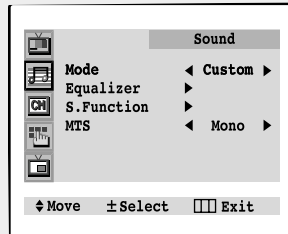

2

Press the **VOL -** or **VOL +** button repeatedly, until the word “Custom” is selected. (When Custom is selected, the words “Equalizer” will appear on the screen.)

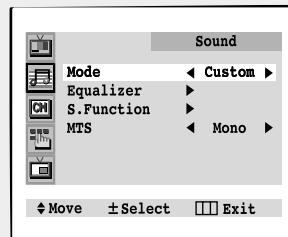

3

Press the **CH ▼** button to select “Equalizer”, then press the **VOL+** button.

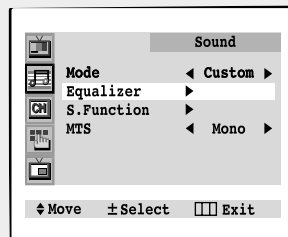

4

Press the **VOL -** or **VOL +** buttons to highlight a particular item to be channel.

Press the **CH ▼** or **CH ▲** buttons to increase or decrease the value of a particular item.

Press the **MENU** button exit.

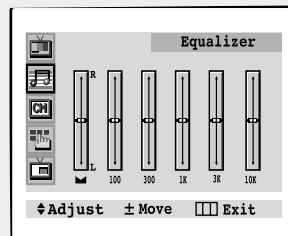

Using Automatic Sound Settings

Your TV has four automatic sound settings (“Standard,” “Music,” “Movie,” and “Speech”) that are preset at the factory. You can activate either Standard, Music, Movie or Speech by pressing the S.MODE button (or by making a selection from the menu). Or, you can select “Custom,” which automatically recalls your personalized sound settings.

1

Press the **MENU** button to display the menu.

Press the **CH ▼** button to select the “Sound”, then press the **VOL +** button.

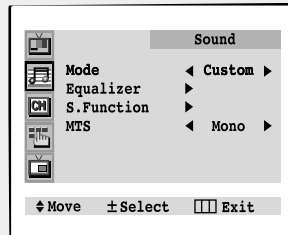

2

Press the **VOL -** or **VOL +** button repeatedly to select the “Standard,” “Music,” “Movie,” “Speech” or “Custom” sound settings.

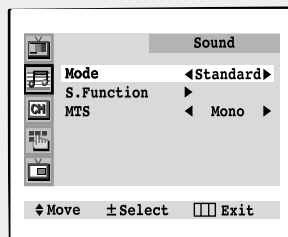

- Choose *Standard* for the standard factory settings.
- Choose *Music* when watching music videos or concerts.
- Choose *Movies* when watching movies.
- Choose *Speech* when watching a show that is mostly dialogue (i.e., news).
- Choose *Custom* to recall your personalized settings.

OPERATION

Viewing an External Signal Source

You must select the appropriate mode in order to view the external signal on the TV.

1

Press the **MENU** button to display the menu.

Press the **CH ▼** button to select "Channel", then press the **VOL+** button.

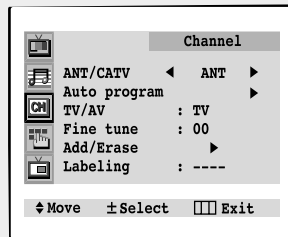

2

Press the **CH ▼** button to select "TV/AV".

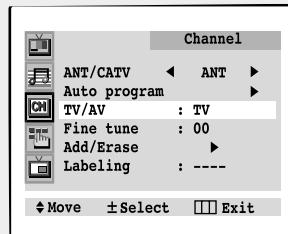

3

Press the **VOL+** or **VOL-** button.

You will switch between viewing the signals coming from equipment connected to the TV's A/V jacks, and the TV signal.

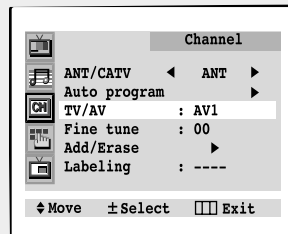

Chapter Four

SPECIAL FEATURES

Customizing Your Remote Control

Your TV comes equipped with a “universal” remote control. In addition to controlling the TV, the universal remote can also operate a VCR, DVD and a cable box (even if your VCR and cable box are made by manufacturers other than Samsung).

Note: The remote control might not be compatible with all DVD players, VCRs, and Cable boxes.

Setting Up Your Remote Control to Operate Your VCR (or DVD)

1

Turn off your VCR.

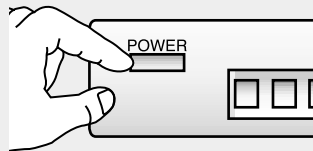

2

Press the **MODE** button and make sure that the **VCR (or DVD)** LED is illuminated.

3

On your Samsung remote control, press the **SET** button.

4

Enter 3 digits of the VCR (or DVD) code listed on the next page for your brand of VCR (or DVD).

5

Press the **POWER** button on the remote control. Your VCR (or DVD) should turn on. If your VCR (or DVD) turns on, your remote control is now set correctly.

6

Once your remote control is set up, press the **MODE** button any time you want to use the remote to operate your VCR (or DVD).

◀ The remote control has four “modes”: “TV,” “VCR,” “Cable” and “DVD.” Press the “MODE” button to switch the remote control to the “VCR” (or DVD) mode.

◀ Make sure you enter 3 digits of the code, even if the first digit is a “0.” If more than one code listed, try the first one.

◀ If your VCR (or DVD) does not turn on, repeat steps 2, 3, and 4, but try one of the other codes listed for the brand of your particular VCR (or DVD). If no other codes are listed, try each code, 000 through 089.

◀ When your remote control is in the “VCR” (or DVD) mode, the volume buttons still control your TV’s volume.

When your remote is in the “TV” mode, the VCR control buttons (PLAY, PAUSE, etc.) will still operate your VCR.

SPECIAL FEATURES

VCR Codes

Admiral	006, 079	KLH	073	RCA	000, 005, 007, 008, 028, 035, 037, 054, 069
Aiwa	015	LG	009, 014, 046, 060	Samsung	007, 013, 022, 032, 042, 077
Akai	017, 022, 023, 027, 030	Lloyd	015	Sansui	016
Audio Dynamics	014, 016	Logik	031	Sanyo	002, 012
Bell & Howell	002	LXI	015	Scott	013, 041, 049, 068
Broksonic	010	Magnavox	008, 029, 053, 056	Sears	002, 005, 009, 012, 018, 019, 035, 043, 048
Candle	007, 009, 013, 045, 046, 052	Marantz	002, 008, 014, 016, 029, 030, 046, 061	Sharp	006, 027, 039, 045
Cannon	008, 053	Marta	009	Shintom	017, 026, 031, 055
Citizen	007, 009, 013, 045, 046, 052	MEI	008	Signature	015
Colortyme	014	Memorex	008, 009, 012, 015	Sony	017, 026, 038
Craig	007, 012	MGA	027	Sylvania	008, 015, 029, 053, 056
Curtis-Mathes	000, 007, 008, 014, 015, 046, 053, 064, 067	Midland	032	Symphonic	015
Daewoo	013, 045, 076	Minota	005, 035	Tandy	002, 015
DBX	014, 016	Mitsubishi	005, 027, 035, 040	Tashiko	009
Dimensia	000	Montgomery ward	006	Tatung	030
Dynatech	015	MTC	007, 015	Teac	015, 030, 069
Electrohome	027	Multitech	007, 015, 031, 032	Technics	008
Emerson	008, 009, 010, 013, 015, 020, 023, 027, 034, 041, 042, 047, 049, 057, 062, 065, 067, 068, 070	NEC	002, 014, 016, 030, 046, 061, 064	Ternika	008, 009, 015, 021
Fisher	002, 012, 018, 019, 043, 048, 058	Optimus	006	TMK	067
Funai	015	Panasonic	008, 053, 075, 077	Toshiba	005, 013, 019, 048, 049
GE	000, 007, 008, 032, 053	Pentax	005, 035	Totevision	007, 009
Go Video	007	Pentex Reserch+	046	Unitech	007
Harman Kardon	014	Philco	008, 029, 053, 056	Vector Research	014, 016
Hitachi	005, 015, 035, 036	Philips	008, 029	Victor	016
Instant Replay	008	Pioneer	005, 016, 033, 050	Video Concepts	014, 016
JC Penney	002, 005, 007, 008, 014, 016, 030, 035, 051, 053	Portland	044, 045, 052	Videosonic	007
JCL	008, 002, 014, 016, 030, 046	ProScan	000	Wards	005, 006, 007, 008, 009, 012, 013, 015, 027, 031, 035
JVC	002, 014, 088, 089	Quartz	002	Yamaha	002, 014, 016, 030, 046
Kenwood	002, 014, 016, 030, 046	Quasar	008, 053	Zenith	011, 017, 026, 079
		Radio Shack/Realistic	002, 006, 008, 009, 012, 015, 019, 027, 045, 053		

DVD Codes

Philips	001
Proscan	002
RCA	002
Toshiba	003
Panasonic	004
Sony	008
Samsung	000

SPECIAL FEATURES

Setting Up Your Remote Control to Operate Your Cable Box

1

Turn off your cable box.

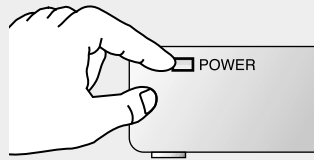

2

Press the **MODE** button and make sure that the **CABLE LED** is illuminated.

3

On your Samsung remote control, press the **SET** button.

4

Enter 3 digits of the cable box code listed below for your brand of cable box.

5

Press the **POWER** button. Your cable box should turn on. If your cable box turns on, your remote control is now "set up" correctly.

6

Once your remote control is set up, press the **MODE** button any time you want to use the remote to operate your cable box.

◀ The remote control has four "modes": "TV," "VCR," "Cable" and "DVD."

Press the "MODE" button to switch the remote control to the "Cable" mode.

◀ Make sure you enter 3 digits of the code, even if the first digit is a "0." (If more than one code listed, try the first one.)

◀ If your cable box does not turn on, repeat steps 2, 3, and 4, but try one of the other codes listed for your particular brand of cable box. (If no other codes are listed, try each cable box code, 000 through 077.)

◀ When your remote control is in the "CABLE" mode, the volume buttons still control your TV's volume. Also, the VCR control buttons (PLAY, PAUSE, etc.) will still operate your VCR.

Cable Box Codes

Anvision	007, 008	NSC	009	Signature	046
Cablestar	007, 008	Oak	016, 038	Sprucer	027
Eagle	007, 008	Osk Sigma	016	Starcom	046
Eastern Int.	002	Panasonic	003, 027, 039, 061, 073, 074	Stargate 2000	058
General Instrument	046	Philips	007, 008, 019, 021, 026, 028, 029, 032, 033, 040, 041	Sylvania	011, 059
GI	004, 005, 015, 023, 024, 025, 030, 036, 067, 068, 069	Pioneer	018, 020, 044, 074, 077	Texscan	011, 059
Hamlin	003, 012, 013, 034, 048	Randtek	007, 008	Tocom	017, 021, 049, 050, 055, 073
Hitachi	037, 043, 046	RCA	000, 027, 066	Unika	031, 032, 041
Jerroid	004, 005, 015, 023, 024, 025, 030, 036, 046, 062, 065	Regal	003, 012, 013	Universal	051, 052
Macom	037, 043	Regency	002, 033	Viewster	007, 008, 019, 021, 026, 028, 029, 032, 033, 040, 041
Magnavox	007, 008, 019, 021, 026, 028, 029, 032, 033, 040, 041	SA	070, 071, 072	Warner Amex	044
		Samsung	044, 003, 022, 063, 064	Zenith	014, 042, 057, 061, 075, 076

Fine Tuning Channels

Use fine tuning to manually adjust a particular channel for optional reception.

1

Select the appropriate channel.

Press **MENU** to display the menu.

Press the **CH ▼** button to select the "Channel", then press the **VOL+** button.

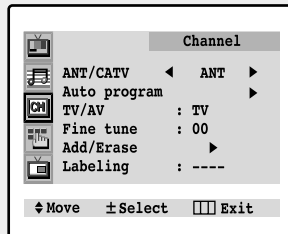

2

Press the **CH ▼** button to select "Fine tune".

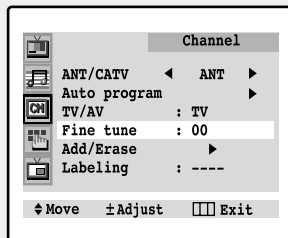

3

Press the **VOL+** and **VOL-** button to adjust the fine tuning.

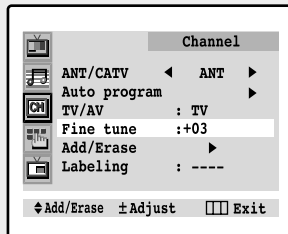

◀ After you adjust the fine tuning, "*" will appear when you press DISPLAY while watching this channel.

4

To store the fine tuning setting in the TV's memory, press the **CH ▲** button. ("*" will appear).

To reset the fine tuning to "00", press the **CH ▼** button.

Press the **MENU** button to exit.

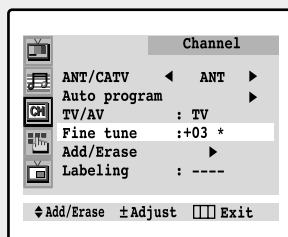

LNA (Low Noise Amplifier)

If the TV is operating in a weak-signal area, sometimes the LNA function can improve the reception (a low-noise preamplifier boosts the incoming signal).

1

Press the **MENU** button to display the menu.

Press the **CH ▼** button twice to select the "Picture", then press the **VOL+** button.

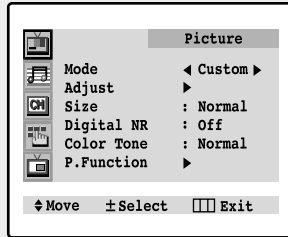

2

Press the **CH ▼** button to select "P.Function", then press the **VOL+** button.

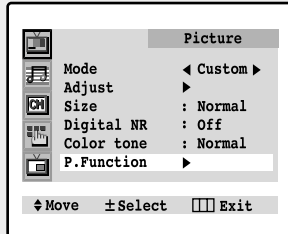

3

Press the **VOL -** or **VOL +** button to select LNA "on."

Press the **MENU** button to exit.

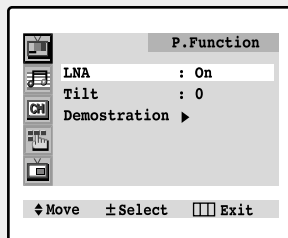

◀ Pressing **VOL -** or **VOL +** will alternate between "On" and "Off."

SPECIAL FEATURES

Tilt

Due to the Earth's magnetic field there may be some minor image tilt depending on the TV's location. When this occurs, follow the steps below.

1

Press the **MENU** button to display the menu.

Press the **CH ▼** button twice to select the "Picture", then press the **VOL+** button.

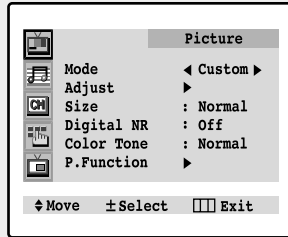

2

Press the **CH ▼** button to select "P.Function", then press the **VOL+** button.

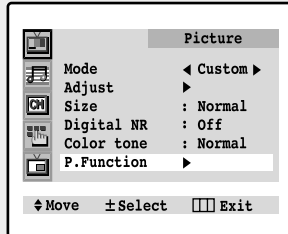

3

Press the **CH ▼** button to select "Tilt", then press the **VOL-** or **VOL+** buttons to adjust the Tilt.

Press the **MENU** button to exit.

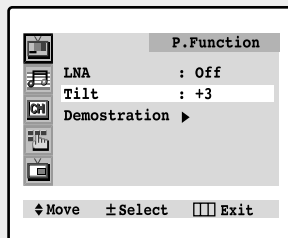

Digital Noise Reduction

If the broadcast signal received by your TV is weak, you can activate the Digital Noise Reduction feature to help reduce any static and ghosting that may appear on the screen.

1

Press the **MENU** button to display the menu, then press the **VOL +** button to select the "Picture" menu.

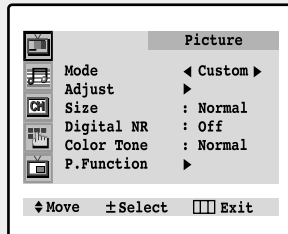

2

Press the **CH ▾** button to select "Digital NR."

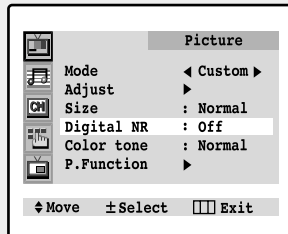

3

Press the **VOL +** or **VOL -** button to select Digital NR "On".

Press the **MENU** button to exit.

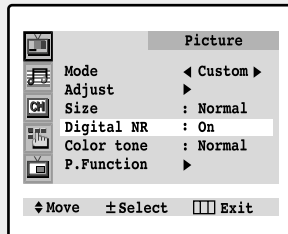

◀ Pressing the **VOL-** or **VOL+** button will alternate between "On" and "Off".

Changing the Screen Size

TXM3097WHF/ TXM3098WHF

Press the **P.SIZE** button to change the screen.

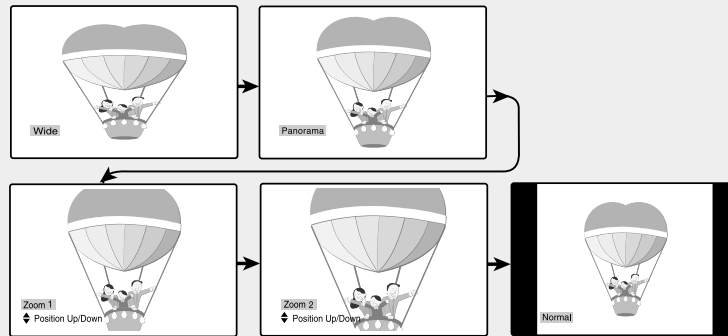

- **Wide:** Sets the picture to 16:9 wide mode.
- **Panorama:** Use this mode for the wide aspect ratio of a panoramic picture.
- **Zoom1:** Magnifies the size of the picture on screen.
You can also move the picture on screen using the joystick up or down.
- **Zoom2:** Magnifies the size of the picture more than Zoom1.
You can also move the picture on screen using the joystick up or down.
- **Normal(4:3):** Sets the picture to 4:3 normal mode.

Notes: Screen size cannot be changed in the PIP mode. When the Aspect button is selected and then the appropriate OSD(On-Screen Display) is displayed, the Channel Up/Down buttons don't operate for about three seconds.

TXM3297HF / TXM2797HF / TXM2796HF / TXM3296HF /
TXM3298HF / TXM2798HF

Press the **P.SIZE** button to change the screen.

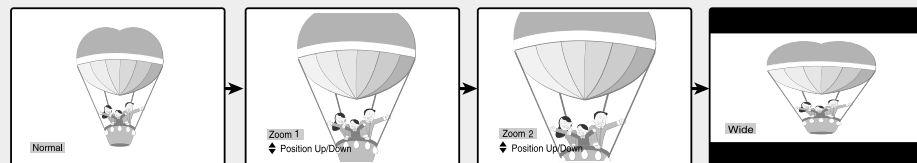

- **Normal:** Sets the picture to 4:3 normal mode.
- **Zoom1:** Magnifies the size of the picture on screen.
You can also move the picture on screen using the joystick up or down.
- **Zoom2:** Magnifies the size of the picture more than Zoom1.
You can also move the picture on screen using the joystick up or down.
- **Wide:** Sets the picture to 16:9 wide mode.

SPECIAL FEATURES

Changing the Color Tone

1

Press the **MENU** button to display the menu, then press the **VOL +** button to select the "Picture" menu.

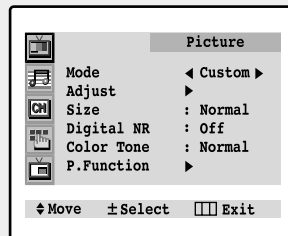

2

Press the **CH ▼** button to select "Color Tone."

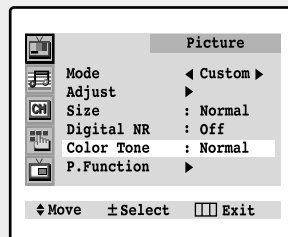

3

Press the **VOL +** or **VOL -** buttons to select "Normal", "Warm" or "Cool" according to personal preference.

Press the **MENU** button to exit.

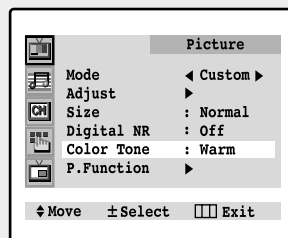

Using the R.Surf Feature

This feature allows you to set the TV to return to a particular channel after a certain amount of time. For example, you may be watching a channel when commercials start. You can set the R.Surf to “5 minutes”, then switch channels. After minutes, the TV will return to the original channel. To use the R.Surf feature:

1

While you are watching the channel to which you want to return, press R.SURF. The on-screen display will read “Surf off”.

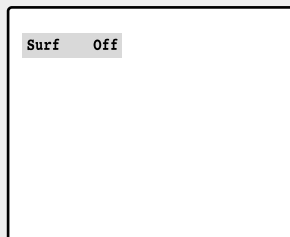

2

Press R.SURF again to set the timer in thirty second intervals, up to five minutes.



3

The time you set will begin counting down on the screen. When the time runs out, the TV will return to the channel you were watching when you set the timer.

Freezing the Picture

1

Press the **STILL** button to freeze a moving picture. (normal sound will still be heard.)

Press again to cancel.

Setting the On/Off Timer

1

Press the **MENU** button to display the menu.

Press the **CH ▼** button to select "Function", then press the **VOL+** button.

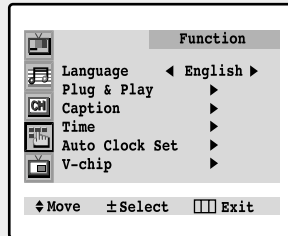

◀ Before using the timer, you must set the TV's clock. (See "Setting the Clock" on page 3.10).

When any of the timers are set, the "Timer" LED will illuminate (front panel of TV.)

2

Press the **CH ▼** button to select "Time", then press the **VOL+** button.

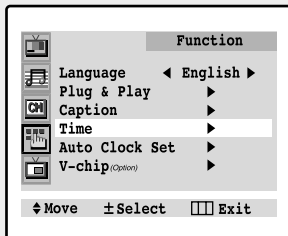

3

Press the **CH ▼** button to select "On time".

Press the **VOL+** button to select the "On time" hours. (The hours digits will be highlighted.)

Press the **CH ▲** or **CH ▼** button repeatedly to select the appropriate hours (i.e., the hour when the TV will turn on.)

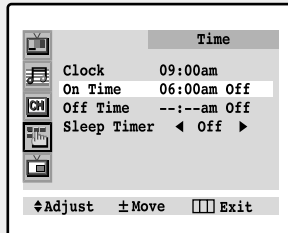

4

Press the **VOL+** button to select the "On time" minutes. (The minutes digits will be highlighted.)

Press the **CH ▲** or **CH ▼** button to select the appropriate minutes.

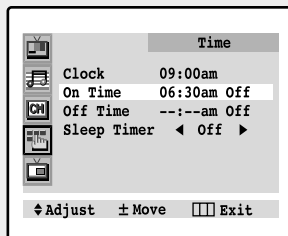

SPECIAL FEATURES

5

Press the **VOL +** button to select "On/Off."

Press the **CH ▲** or **CH ▼** button to turn the on-timer "On." (Repeatedly pressing the **CH ▲** or **CH ▼** button will alternate between on and off.)

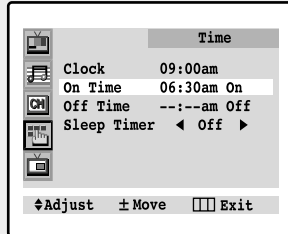

◀ To deactivate the "On time," select "Off" during this step.

6

When finished, press the **VOL +** button.

7

To set the Off time, press the **CH ▼** button to select "Off time."

Press the **VOL +** button and set the hours and minutes. (Follow the same procedure as in steps 1-6 above.)

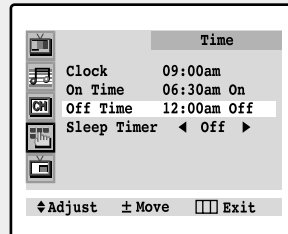

◀ If no function buttons (including remote control buttons or front panel buttons) are operated for three hours after the TV is turned on with the by "On time" feature, the TV will be automatically turned off.

8

When finished setting the timer, press the **MENU** button to exit.

Setting the Sleep Timer

The sleep timer automatically shuts off the TV after a preset time (from 10 to 180 minutes).

1

Press the **SLEEP** button on the remote control.

2

Press the **SLEEP** button repeatedly until the appropriate time interval appears (any of the preset values from "Off" to "180").

◀ After about 5 seconds, the sleep display will disappear from the screen, and the time interval will be set.

Sound Features

Choosing a Multi-Channel Sound (MTS) Soundtrack

Depending on the particular program being broadcast, you can listen to Stereo, Mono, or a Separate Audio Program. (SAP audio is usually a foreign-language translation. Sometimes SAP has unrelated information like news or weather.)

1

Press the **MENU** button to display the menu.

Press the **CH** button once to select the "Sound", then press the **VOL+** button.

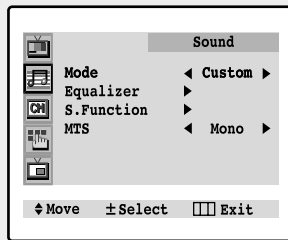

◀ Quick way to access the MTS: Just press the "MTS" button on the remote control.

2

Press the **CH** button to select "MTS".

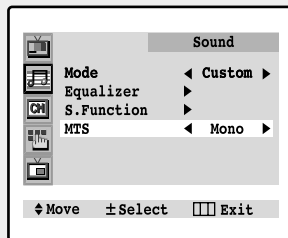

3

Press the **VOL +** or **VOL -** button repeatedly to select "Mono," "SAP," or "Stereo."

Press the **MENU** button to exit.

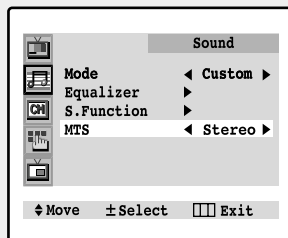

◀ The text at the bottom of the menu tells you if the incoming audio is stereo, SAP, or mono.

- Choose *Stereo* for channels that are broadcasting in stereo.
- Choose *Mono* for channels that are broadcasting in mono, or if you are having difficulty receiving a stereo signal.
- Choose *SAP* to listen to the Separate Audio Program, which is usually a foreign-language translation.

SPECIAL FEATURES

Extra sound settings (Turbo Sound, Surround, Auto Volume, Melody, BBE or Virtual surround)

The following sound settings can be adjusted to suit your personal preferences.

- **Turbo Sound**

Turbo sound emphasizes the bass and treble frequencies to add fullness to the sound.

- **Surround**

Your Samsung TV can create a "surround" effect such that the sound seems to come from all directions. Once the "Surround" is set to "On", the setting applies to sound effects such as Standard, Music, Movie and Speech.

- **Auto Volume**

Each broadcasting station has its own signal conditions, which can make it necessary to adjust the volume every time the channel is changed. "Auto volume" lets you automatically adjust the volume of the desired channel by lowering the sound output when the modulation signal is high or by raising the sound output when the modulation signal is low.

- **Melody**

You can hear clear a melody sound when the TV is powered on or Off.

- **BBE(TXM3297HF / TXM3097WHF / TXM2797HF)**

A Sound related function that operates the treble, bass, and boost the function based to 650dB standards and reverses the phase to produce replicated sound that is close to the original sound.

- **Virtual surround(TXM3298HF / TXM3098WHF / TXM2798HF)**

This function allows the TV L/R speakers to provide a home-like Dolby effect. The center and surround sounds are mixed up into the L/R speakers.

Manufactured under license from Dolby Laboratories.

"Dolby" and the double-D symbol are trademarks of Dolby Laboratories. Confidential unpublished works. © 1992-1997 Dolby Laboratories. All rights reserved.



continued...

SPECIAL FEATURES

1

Press the **MENU** button to display the menu.

Press the **CH** button to select the "Sound", then press the **VOL +** button.

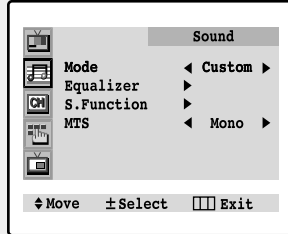

2

Press the **CH** button to select "S.Function", then press the **VOL +** button.

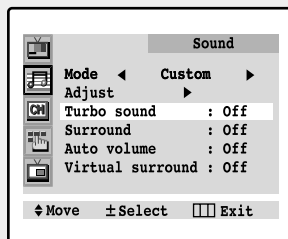

3

Press the **CH** or **CH** button to select the required item, then press the **VOL +** button to select "On".

Press the **MENU** button to exit

TXM3297HF / TXM3097WHF
TXM2797HF / TXM2796HF
TXM3296HF

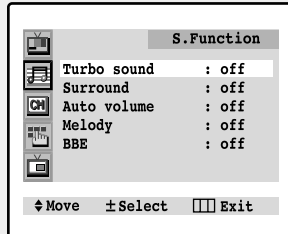

TXM3298HF / TXM3098WHF
TXM2798HF

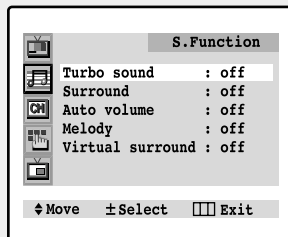

◀ Note:

Note: Turbo sound and BBE are exclusive relation.

Viewing Closed Captions

Your TV decodes and displays the closed captions that are broadcast with certain TV shows. These captions are usually subtitles for the hearing impaired or foreign-language translations. All VCRs record the closed caption signal from television programs, so home-recorded video tapes also provide closed captions. Most pre-recorded commercial video tapes provide closed captions as well. Check for the closed caption symbol in your television schedule and on the tape's packaging: .

1

Press the **MENU** button to display the menu.

Press the **CH** \blacktriangledown button to select the "Function", then press the **VOL+** button.

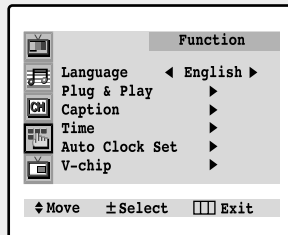

2

Press the **CH** \blacktriangledown button to select the "Caption", then press the **VOL+** button.

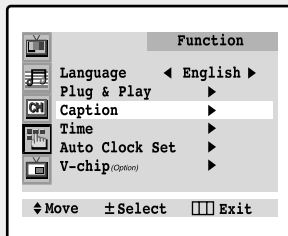

3

Press the **VOL -** or **VOL +** button to turn closed captioning on/off.

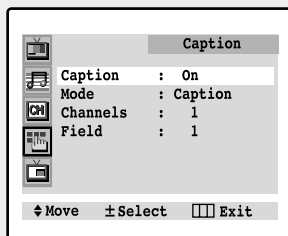

4

Press the **CH** \blacktriangledown button to select "Mode", then press **VOL -** or **VOL +** to select "Caption" or "Text."

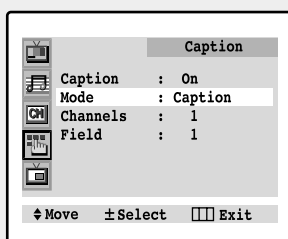

5

Depending on the particular broadcast, it might be necessary to make changes to "Channels" and "Field": Use the **CH** \blacktriangle , **CH** \blacktriangledown , **VOL +** and **VOL -** buttons to make the changes. (Follow the same procedure as in steps 3-4 above.) Press the **MENU** button to exit.

◀ Misspellings and unusual characters sometimes occur during closed caption transmissions, especially those of live events. There may be a small delay before captions appear when you change channels. These are not malfunctions of the TV.

◀ In **caption mode**, captions appear at the bottom of the screen, and they usually cover only a small portion of the picture.

In **text mode**, information unrelated to the program, such as news or weather, is displayed. Text often covers a large portion of the screen.

◀ Different channels and fields display different information: Field 2 carries additional information that supplements the information in Field 1. (For example, Channel 1 may have subtitles in English, while Channel 2 has subtitles in Spanish.)

Viewing Picture-in-Picture

You can use the PIP feature to simultaneously watch two video sources.
 Note: The PIP feature does not work with DVD signals and S-Video mode.

When PIP is selected in the Zoom mode, the Mode is automatically converted into the Normal mode.

Activating Picture-in-Picture

1

Press the **MENU** button to display the menu.

Press the **CH**▼ to select the "PIP", then press the **VOL +** button.

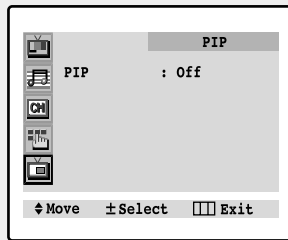

◀ Quick way to access the PIP:
 Just press the PIP/SIZE button on the remote control.

2

Press the **VOL +** button to select PIP "On."

Press the **MENU** button to exit.

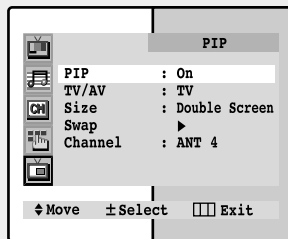

◀ If you turn TV off while watching and turn it on again, the PIP window will disappear.

SPECIAL FEATURES

Selecting a Signal Source (External A/V) for PIP

1

Press the **MENU** button to display the menu.

Press the **CH**▼ to select the "PIP", then press the **VOL +** button.

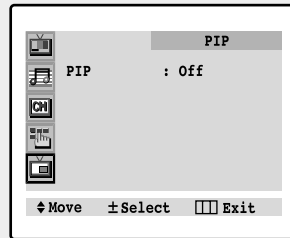

◀ Quick way to access the PIP source: Just press the TV/VIDEO button (blue color) on the remote control.

2

Press the **VOL +** button to select PIP "On."

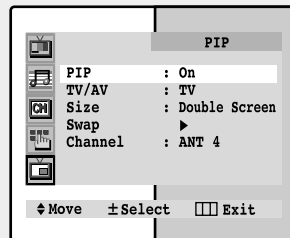

3

Press the **CH**▼ to select the "TV/AV", then press the **VOL +** button repeatedly to cycle through all of the available signal sources: "TV", "AV1", "AV2" and "AV3".

Press the **MENU** button to exit.

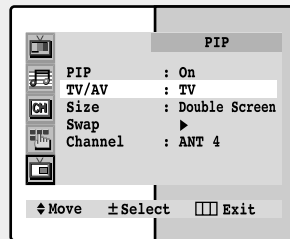

◀ For more information about external A/V components and signals, see "Viewing an External Signal Source" on page 3.17.

If you select "TV", the PIP image is the same as the main image.

SPECIAL FEATURES

Changing the Size of the PIP Window

1

Press the **MENU** button to display the menu.

Press the **CH**▼ to select the "PIP", then press the **VOL +** button.

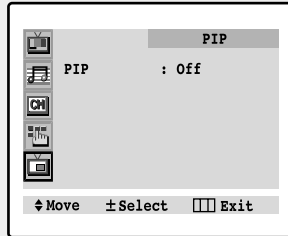

2

Press the **VOL +** button to select PIP "On."

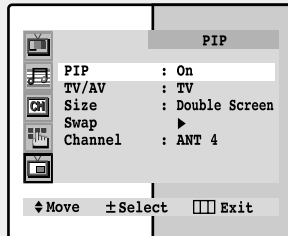

3

Press the **CH**▼ to select the "Size", then press the **VOL +** button repeatedly to select the "Double Screen", "Large Screen", "Small Screen" or "Stock ticker".

Press the **MENU** button to exit.

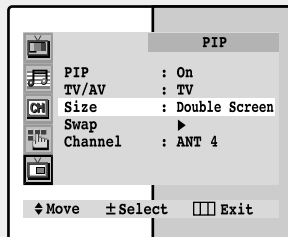

◀ Quick way to access the PIP size:
Just press the **SIZE** button on the remote control.

Press the **SIZE** button repeatedly to cycle through this sequence: double screen window, large window, small window and stock ticker window.

<TXM3298HF / TXM3098WHF / TXM2798HF>

SPECIAL FEATURES

Swapping the Contents of the PIP image and Main image

1

Press the **MENU** button to display the menu.

Press the **CH**▼ to select the "PIP", then press the **VOL +** button.

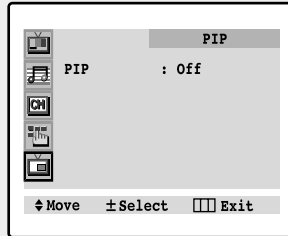

◀ Quick way to access the SWAP: Just press the SWAP button on the remote control.

2

Press the **VOL +** button to select PIP "On."

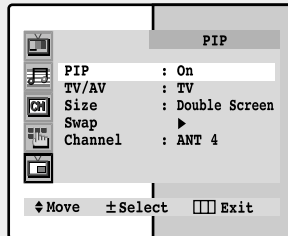

3

Press the **CH**▼ to select the "Swap", then press the **VOL +** button. The image in the PIP window will appear on the main screen, and vice versa.

Press the **MENU** button to exit.

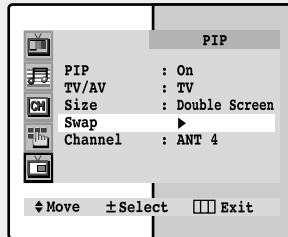

SPECIAL FEATURES

Changing the PIP Channel

1

Press the **MENU** button to display the menu.

Press the **CH▼** to select the "PIP", then press the **VOL +** button.

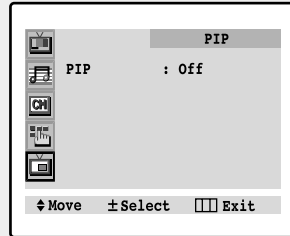

◀ Quick way to access the PIP channel:
Just press the CH▲ or CH▼ button (blue color) on the remote control.

2

Press the **VOL +** button to select PIP "On."

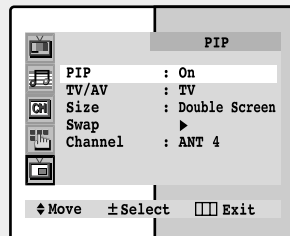

3

Press the **CH▼** to select the "Channel", then press the **VOL +** button.

Press the **CH▲** or **CH▼** button to change the channel that appears in the PIP window.

Press the **MENU** button to exit.

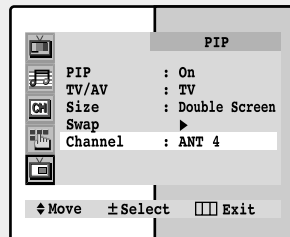

Using the V-Chip

The V-Chip feature automatically locks out programming that is deemed inappropriate for children. The user must first enter a PIN (personal ID number) before any of the V-Chip restrictions can be set up or changed.

Note : When the V-chip feature is active, channel-auto program features do not function.

Setting Up Your Personal ID Number (PIN)

1

Press the **MENU** button to display the menu.

Press the **CH ▾** button to select the "Function", then press the **VOL +** button.

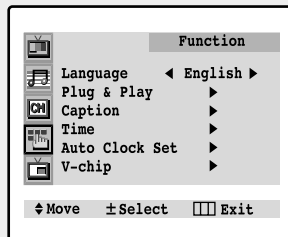

2

Press the **CH ▾** button to select the "V-chip", then press the **VOL +** button.

The "Enter Pin" screen will appear. Enter your 4-digit PIN number,

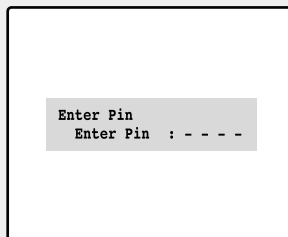

Note: The default PIN number for a new TV set is "0-0-0-0."

3

After entering a valid PIN number, the "V-chip" screen will appear. Press the **CH ▾** button and select "Change pin."

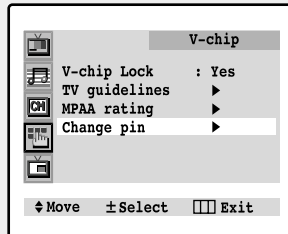

4

While the "Change pin" field is selected, press the **VOL +** button.

The Change pin screen will appear. Choose any 4-digits for your PIN and enter them.

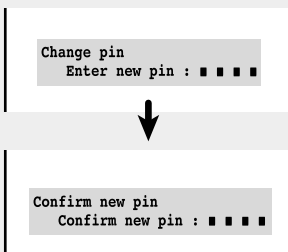

As soon as the 4 digits are entered, the "Confirm new pin" screen appears. Re-enter the same 4 digits. When the Confirm screen disappears, your PIN has been memorized. Press the **MENU** button to exit.

◀ Note: If you forget the PIN, press the remote-control keys in the following sequence, which resets the pin to 0-0-0-0:

POWER OFF → MUTE → 8 → 2 → 4 → POWER ON.

SPECIAL FEATURES

How to Enable/Disable the V-Chip

1

Press the **MENU** button to display the menu.

Press the **CH ▼** button to select the "Function", then press the **VOL +** button.

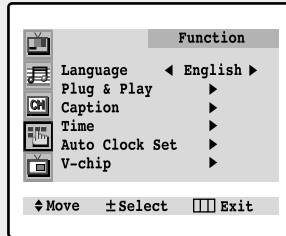

2

Press the **CH ▼** button to select the "V-chip", then press the **VOL +** button.

The "Enter Pin" screen will appear. Enter your 4-digit PIN number,

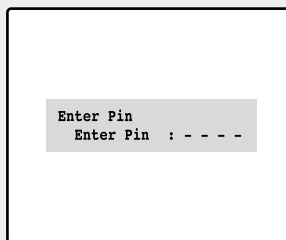

3

To enable the V-Chip feature, press the **VOL +** button so that the "V-Chip lock" field is Yes. (Pressing the **VOL +** button will alternate between Yes and No.)

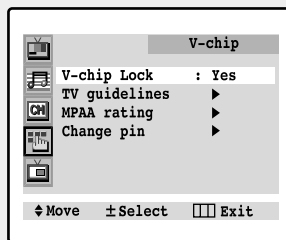

How to Set up Restrictions Using the "TV guidelines"

First, set up a personal identification number (PIN), and enable the V-Chip. (See previous section.) Parental restrictions can be set up using either of two methods: The TV guidelines or the MPA rating.

1

Press the **MENU** button to display the menu.

Press the **CH ▼** button to select the "Function", then press the **VOL +** button.

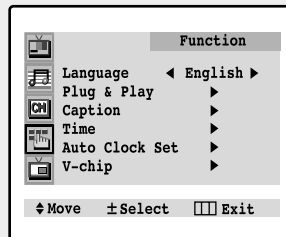

2

Press the **CH ▼** button to select the "V-chip", then press the **VOL +** button.

The "Enter Pin" screen will appear. Enter your 4-digit PIN number,

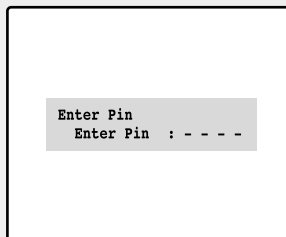

SPECIAL FEATURES

3

Press the **CH ▼** button to select the "TV guidelines", then press the **VOL +** button.

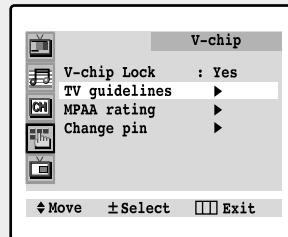

4

The "TV guidelines" screen will appear. Press the **CH ▲**, **CH ▼** buttons to select one of the six age-based categories:

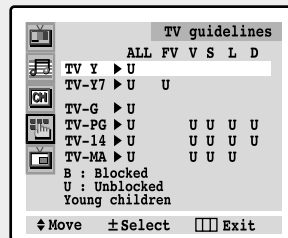

TV-Y	Young children
TV-Y7	Children 7 and over

TV-G	General audience
TV-PG	Parent Guidance
TV-14	Viewers 14 and over
TV-MA	Mature audience

◀ **Note:** These categories consist of two separate groups: TV-Y and TV-Y7 (young children through age 7), and TV-G through TV-MA (everybody else).

The restrictions for these two groups work independently: If a household includes very young children as well as young adults, the TV guidelines must be set up separately for each age group. (See next step.)

5

At this point, one of the TV-Ratings is selected (blue color).

Press the **VOL +** button: Depending on your existing setup, a letter "U" or "B" will start blinking. (U= Unblocked, B= Blocked)

While the "U" or "B" is red, press the **CH ▲** or **CH ▼** button to block or unblock the category.

Press the **MENU** button once to save the TV guidelines. A TV-Rating will be selected (BLUE), and no letters will blink. To exit this screen, press the **MENU** button again. To select a different TV-Rating, press the **CH ▲** or **CH ▼** button and then repeat the process.

Note 1: The TV-Y7, TV-PG, TV-14 and TV-MA have additional options. See the next step to change any of the following sub-ratings:

FV: Fantasy violence
 D: Dialog
 L: Adult language
 S: Sexual situation
 V: Violence

Note 2: The V-Chip will automatically block certain categories that are "more restrictive." For example, if you block "TV-Y" category, then TV-Y7 will automatically be blocked. Similarly, if you block the TV-G category, then all the categories in the "young adult" group will be blocked (TV-G, TV-PG, TV-14 and TV-MA). The sub-ratings (D, L, S, V) work together similarly. (See next section.)

SPECIAL FEATURES

6

How to set the FV, D, L, S and V sub-ratings:

First, select one of these TV-Ratings: TV-Y7, TV-PG, TV-14 or TV-MA (See Step 4, on previous page).

Next, while the TV-Rating is selected (BLUE), repeatedly press the **VOL +** button. This will cycle through the available sub-ratings (FV, L, S, D or V).

A blinking letter ("U" or "B") will be displayed for each sub-rating. While the "U" or "B" is blinking, press the **CH ▲** or **CH ▼** button to change the sub-rating.

Press the **MENU** button once to save the TV guidelines. A TV-Rating will be selected (BLUE), and no letters will blink. To exit this screen, press the **MENU** button again. To select a different TV-Rating, press the **CH ▲** or **CH ▼** button and then repeat the process.

Note: The V-chip will automatically block certain categories that are "More restrictive". For example, if you block "L" sub-rating in TV-PG, then the "L" sub-ratings in TV-14 and TV-MA will automatically be blocked.

7

Press the **MENU** button three times to clear all the screens. (Or proceed to the next section, and set up additional restrictions based on the MPAA codes).

How to Set up Restrictions using the MPAA Ratings: G, PG, PG-13, R, NC-17, X

The MPAA rating system uses the Motion Picture Association of America (MPAA) system, and its main application is for movies. (Eventually, movie videocassettes will be encoded with MPAA ratings.) When the V-Chip lock is on, the TV will automatically block any programs that are coded with objectionable ratings (either MPAA or TV-Ratings).

1

Press the **MENU** button to display the menu.

Press the **CH ▼** button to select the "Function", then press the **VOL +** button.

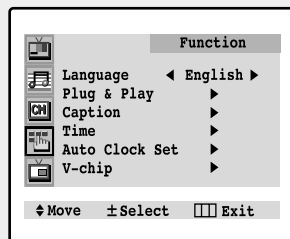

2

Press the **CH ▼** button to select the "V-chip", then press the **VOL +** button.

The "Enter Pin" screen will appear. Enter your 4-digit PIN number,

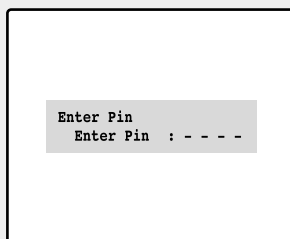

continued...

SPECIAL FEATURES

3

The "V-chip" screen will appear. Press the **CH ▼** button to select "MPAA rating", then press the **VOL +** button.

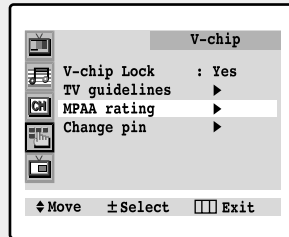

4

The "MPAA rating" screen will appear. Repeatedly press the **CH ▼** button to select a particular MPAA category. Pressing the **CH ▼** button will cycle through the MPAA categories:

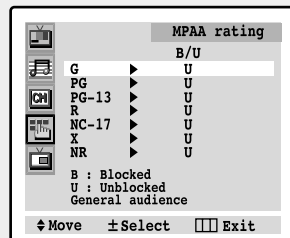

- G** General audience (no restrictions).
- PG** Parental guidance suggested.
- PG-13** PG-13 (Parents strongly cautioned).
- R** R (Restricted. Children under 17 should be accompanied by an adult).
- NC-17** No children under age 17.
- X** X (Adults only).
- NR** Not rated.

While a particular category is selected, press **VOL +** to activate it. A letter ("U" or "B") will be displayed. Press the **CH ▲** or **CH ▼** button to select "U" or "B".

Press the **MENU** button to save the settings and to clear all screens.

◀ Note: The V-Chip will automatically block any category that is "more restrictive." For example, if you block the "PG-13" category, then "R," "NC-17," and "X" will automatically be blocked also.

How to Reset the TV after the V-Chip Blocks a Channel ("Emergency Escape")

If the TV is tuned to a restricted channel, the V-Chip will block it. The screen will go blank and the following message will appear: "Excessive rating."

To resume normal viewing, tune to a different channel using the number buttons. Under certain conditions (depending on the rating of the local TV programs) the V-Chip might lock out all the channels. In this case, use the V-Chip function for an "emergency escape":

Press the **MENU** button to display the menu. Press the **CH ▼** button to select the "Function" menu and press the **VOL +** button.

Press the **CH ▼** button to select the "V-chip" menu and press the **VOL +** button. Enter your PIN number, and press the **VOL +** button to temporarily disable the V-Chip Lock.

Viewing the Demonstration

To become familiar with the various menus provided by your television, you can view the in built demonstration.

1

Press the **MENU** button to display the menu.

Press the **CH ▼** button twice to select the "Picture", then press the **VOL+** button.

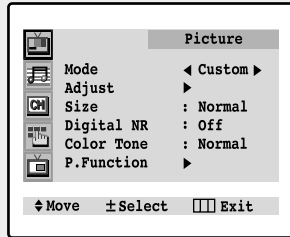

2

Press the **CH ▼** button to select "P.Function", then press the **VOL+** button.

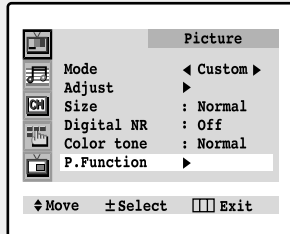

3

Press the **CH ▼** button to select "Demonstration", then press the **VOL+** button.

Each of the menu options is displayed in turn.

When you wish to stop the demonstration, press any button on the remote control.

Press the **MENU** button to exit.

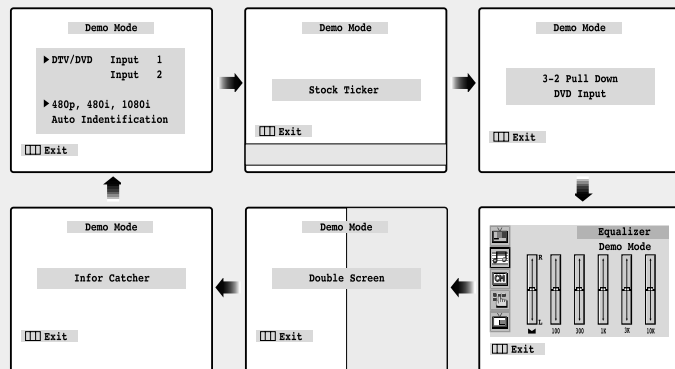

Chapter Five

TROUBLESHOOTING

If the TV seems to have a problem, first try this list of possible problems and solutions. If none of these troubleshooting tips apply, then call your nearest service center.

Identifying Problems

Problem	Possible Solution
Poor picture	Try another channel. Adjust the antenna. Check all wire connections.
Poor sound quality.	Try another channel. Adjust the antenna.
No picture or sound.	Try another channel. Press the TV/VIDEO button. Make sure the TV is plugged in. Check the antenna connections.
No color, wrong colors or tints.	Make sure the program is broadcast in color. Adjust the picture settings. If the set is moved or turned in a different direction, the power should be OFF for at least 30 minutes.
Picture rolls vertically.	Adjust the antenna. Check all wire connections.
The TV operates erratically	Unplug the TV for 30 seconds, then try operating it again.
The TV won't turn on.	Make sure the wall outlet is working.

APPENDIX

Cleaning and Maintaining Your TV

With proper care, your TV unit will give you many years of service. Please follow these guidelines to get the maximum performance from your TV.

Placement

- Do not place the TV near extremely hot, cold, humid or dusty places.
- Do not place the TV near appliances with electric motors that create magnetic fields, such as vacuum cleaners.
- Keep the ventilation openings clear; do not place the TV on a soft surface, such as cloth or paper.
- Place the TV in a vertical position only.

Liquids

- Do not handle liquids near or on the TV. Liquids that spill into it can cause serious damage.

Cabinet

- Never open the cabinet or touch the parts inside.
- Wipe your TV with a clean, dry cloth. Never use water, cleaning fluids, wax, or chemicals.
- Do not put heavy objects on top of the cabinet.

Temperature

- If your TV is suddenly moved from a cold to a warm place, unplug the power cord, and allow at least two hours for moisture that may have formed inside the unit to dry completely.

Using Your TV in Another Country

If you plan to take your TV with you to a foreign country, please be aware of the different television systems that are in use around the world. A TV designed for one system may not work properly with another system due to differences in the TV channel frequencies

Specifications

Model	TXM2797HF / TXM2796HF TXM2798HF	TXM3097HF TXM3098WHF	TXM3296HF / TXM3297HF TXM3298HF
Voltage	120 V ca	120 V ca	120 V ca
Frequency of Operation	60Hz	60Hz	60Hz
Power Consumption	100 W	100 W	100 W
Dimensions (mm/inches)	745 x 498 x 570 / 29.33 x 19.61 x 22.44 704 x 542 x 619 / 27.72 x 21.34 x 24.37	890 x 576 x 558 / 35.04 x 22.68 x 21.97 830 x 557 x 619 / 32.68 x 21.93 x 24.37	910 x 612 x 685 / 35.83 x 24.09 x 26.97 836 x 582 x 719 / 32.91 x 22.91 x 28.31
Weight (Kg/lbs)	46 / 101.41 46.5 / 102.52	46 / 101.41 57.8 / 127.43	67 / 147.71 68.8 / 151.68

MEMO

MEMO

MEMO

Free Manuals Download Website

<http://myh66.com>

<http://usermanuals.us>

<http://www.somanuals.com>

<http://www.4manuals.cc>

<http://www.manual-lib.com>

<http://www.404manual.com>

<http://www.luxmanual.com>

<http://aubethermostatmanual.com>

Golf course search by state

<http://golfingnear.com>

Email search by domain

<http://emailbydomain.com>

Auto manuals search

<http://auto.somanuals.com>

TV manuals search

<http://tv.somanuals.com>