

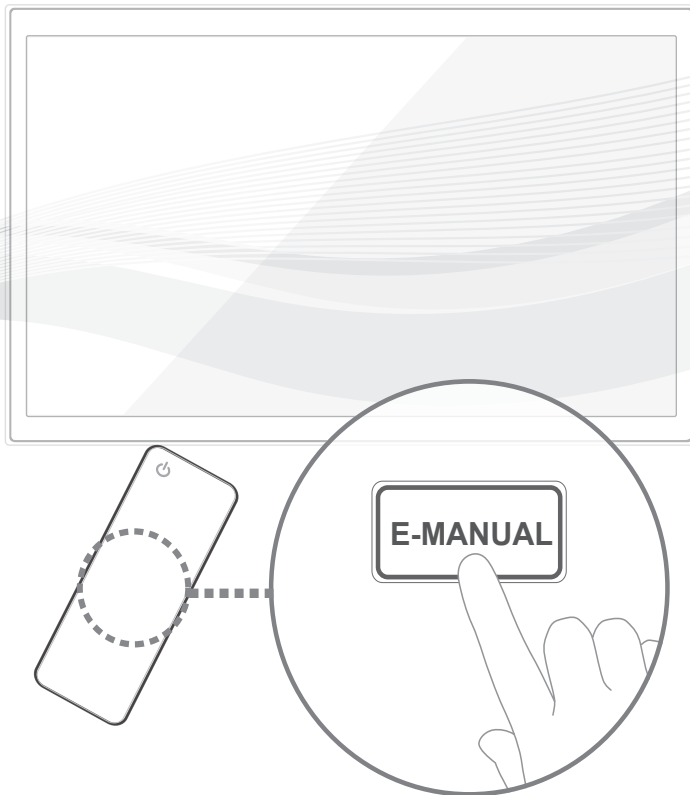

LCD TV

User Manual



imagine the possibilities

Thank you for purchasing this Samsung product.
To receive more complete service, please register
your product at

www.samsung.com/register

Model _____ Serial No. _____

For more information on how to use e-Manual (P.12)

Figures and illustrations in this User Manual are provided for reference only and may differ from actual product appearance. Product design and specifications may be changed without notice.

Important Warranty Information Regarding Television Format Viewing

1. Functionalities related to Digital TV (DVB) are only available in countries/areas where DVB-T (MPEG2 and MPEG4 AVC) digital terrestrial signals are broadcasted or where you are able to access to a compatible DVB-C (MPEG2 and MPEG4 AAC) cable-TV service. Please check with your local dealer the possibility to receive DVB-T or DVB-C signal.
2. DVB-T is the DVB European consortium standard for the broadcast transmission of digital terrestrial television and DVB-C is that for the broadcast transmission of digital TV over cable. However, some differentiated features like EPG (Electric Programme Guide), VOD (Video On Demand) and so on, are not included in this specification. So, they cannot be workable at this moment.
3. Although this TV set meets the latest DVB-T and DVB-C standards, as of [August, 2008], the compatibility with future DVB-T digital terrestrial and DVB-C digital cable broadcasts cannot be guaranteed.
4. Depending on the countries/areas where this TV set is used some cable-TV providers may charge an additional fee for such a service and you may be required to agree to terms and conditions of their business.
5. Some Digital TV functions might be unavailable in some countries or regions and DVB-C might not work correctly with some cable service providers.
6. For more information, please contact your local Samsung customer care centre.

 The reception quality of TV may be affected due to differences in broadcasting method between the countries. Please check the TV performance in the local SAMSUNG Authorized Dealer, or the Samsung Call Centre whether it can be improved by reconfiguring TV setting or not.



Still image warning

Avoid displaying still images (like jpeg picture files) or still image element (like TV programme logo, panorama or 4:3 image format, stock or news bar at screen bottom etc.) on the screen. Constant displaying of still picture can cause ghosting of LCD screen, which will affect image quality. To reduce risk of this effect, please follow below recommendations:

- Avoid displaying the same TV channel for long periods.
- Always try to display any image on full screen, use TV set picture format menu for best possible match.
- Reduce brightness and contrast values to minimum required to achieve desired picture quality, exceeded values may speed up the burnout process.
- Frequently use all TV features designed to reduce image retention and screen burnout, refer to proper user manual section for details.

Securing the Installation Space

Keep the required distances between the product and other objects (e.g. walls) to ensure proper ventilation. Failing to do so may result in fire or a problem with the product due to an increase in the internal temperature of the product.

-  When using a stand or wall-mount, use parts provided by Samsung Electronics only.
 - If you use parts provided by another manufacturer, it may result in a problem with the product or an injury due to the product falling.
-  The appearance may differ depending on the product.
-  Be careful when you contact the TV because some parts can be somewhat hot.

Installation with a stand.

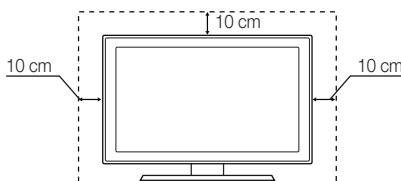

Installation with a wall-mount.

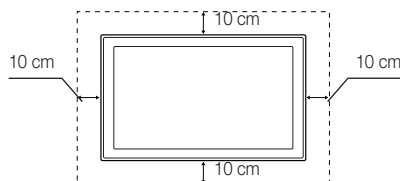

Correct Disposal of This Product (Waste Electrical & Electronic Equipment)

(Applicable in the European Union and other European countries with separate collection systems)



This marking on the product, accessories or literature indicates that the product and its electronic accessories (e.g. charger, headset, USB cable) should not be disposed of with other household waste at the end of their working life. To prevent possible harm to the environment or human health from uncontrolled waste disposal, please separate these items from other types of waste and recycle them responsibly to promote the sustainable reuse of material resources. Household users should contact either the retailer where they purchased this product, or their local government office, for details of where and how they can take these items for environmentally safe recycling. Business users should contact their supplier and check the terms and conditions of the purchase contract. This product and its electronic accessories should not be mixed with other commercial wastes for disposal.





Correct disposal of batteries in this product

(Applicable in the European Union and other European countries with separate battery return systems)





This marking on the battery, manual or packaging indicates that the batteries in this product should not be disposed of with other household waste at the end of their working life. Where marked, the chemical symbols Hg, Cd or Pb indicate that the battery contains mercury, cadmium or lead above the reference levels in EC Directive 2006/66. If batteries are not properly disposed of, these substances can cause harm to human health or the environment. To protect natural resources and to promote material reuse, please separate batteries from other types of waste and recycle them through your local, free battery return system.

Accessories

-  Please make sure the following items are included with your TV. If any items are missing, contact your dealer.
-  The items' colours and shapes may vary depending on the models.
-  Cables not included in the package contents can be purchased separately.
-  Check that there is no accessory hidden behind packing materials when you open the box.





- Remote Control & Batteries (AAA x 2)
- Owner's Instructions
- Power Cord
- Cleaning Cloth

-  An administration fee may be charged if either
 - (a) an engineer is called out at your request and there is no defect in the product (i.e. where you have failed to read this user manual)
 - (b) you bring the unit to a repair centre and there is no defect in the product (i.e. where you have failed to read this user manual).
-  The amount of such administration charge will be advised to you before any work or home visit is carried out.

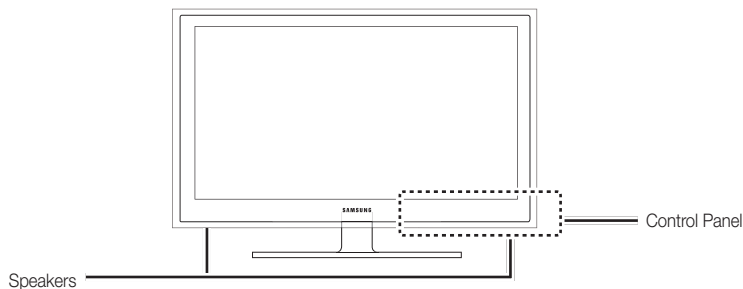
Viewing the Control Panel

-  The product colour and shape may vary depending on the model.



Remote control sensor	Aim the remote control towards this spot on the TV.
Power Indicator	Blinks and turns off when the power is on and lights up in standby mode.
SOURCE 	Toggles between all the available input sources. In the on-screen menu, use this button as you would use the ENTER  button on the remote control.
MENU	Displays an on-screen menu, the OSD (on screen display) of your TV's features.
-  +	Adjusts the volume. In the OSD, use the -  + buttons as you would use the ◀ and ▶ buttons on the remote control.
▼ CH ▲	Changes the channels. In the OSD, use the ▼ CH ▲ buttons as you would use the ▼ and ▲ buttons on the remote control.
 (Power)	Turns the TV on or off.

Standby mode

Do not leave your TV in standby mode for long periods of time (when you are away on a holiday, for example). A small amount of electric power is still consumed even when the power button is turned off. It is best to unplug the power cord.

Viewing the Remote Control

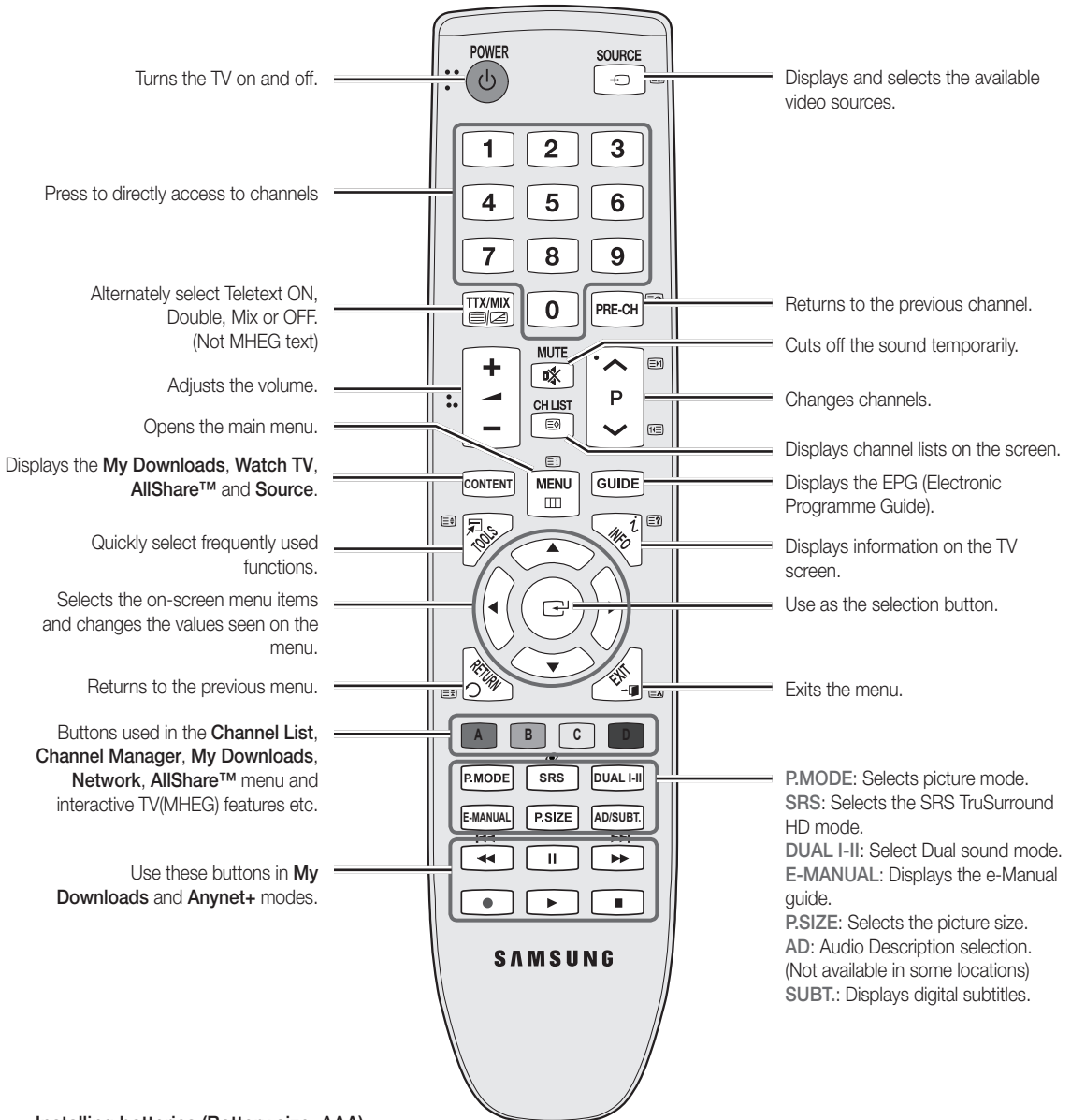

Installing batteries (Battery size: AAA)

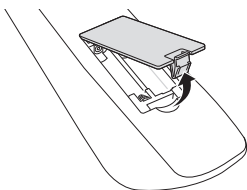

Remove the battery cover located on the back of the handset by gently pulling downwards from the indicated part.

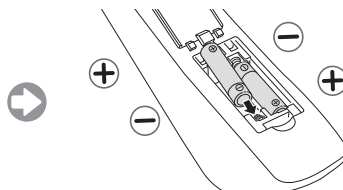

Insert two **AAA/R6** or equivalent type batteries inside. Place the batteries in the right directions.

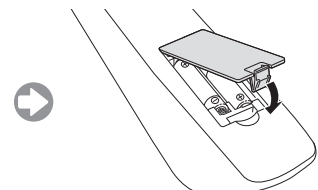

Replace the battery cover.

Remove the batteries from remote control handset when it is not to be used for a long period. Otherwise it can be damaged due to any leakage of batteries.

Connecting to an Antenna

When the TV is initially powered on, basic settings proceed automatically.



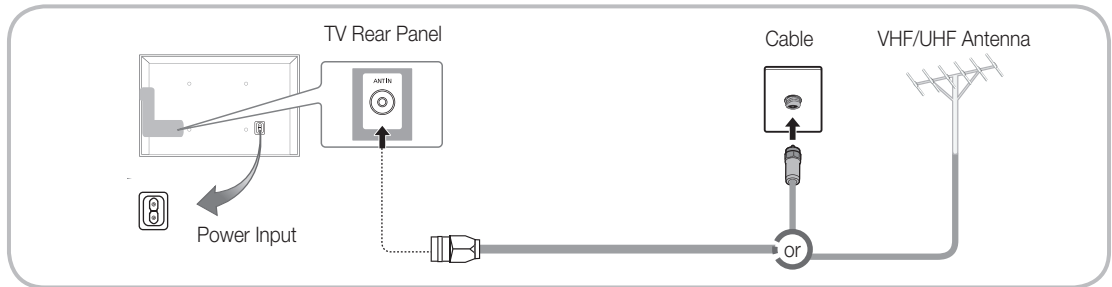

 Preset: Connecting the mains and antenna.



Plug & Play (Initial Setup)

When the TV is initially powered on, a sequence of on-screen prompts will assist in configuring basic settings. Press the **POWER** button. **Plug & Play** is available only when the Input source is set to TV.

 To return to the previous step, press the Red button.

1	Selecting a language	Press the ▲ or ▼ button, then press the ENTER button. Select the desired OSD (On Screen Display) language.	
2	Selecting Store Demo or Home Use	Press the ◀ or ▶ button, then press the ENTER button. Select the Home Use mode. Store Demo mode is for retail environments. To return the unit's settings from Store Demo to Home Use (standard): Press the volume button on the TV. When the OSD volume is displayed, press and hold MENU for 5 sec. Store Demo is only for shop display. If you select it, several functions are not able to use. Please select Home Use when you watch at home.	
3	Selecting a country	Press the ▲ or ▼ button, then press the ENTER button. Select the appropriate country.  After selecting the country in the Country menu, some models may proceed with an additional option to setup the pin number.  When you input the PIN number, 0-0-0-0 is not available.	
4	Setting the Clock Mode	Set the Clock Mode automatically or manually.	
5	Selecting an antenna	Press the ▲ or ▼ button, then press the ENTER button. Select Air (Digital & Analogue/Digital/Analogue) or Cable (Digital & Analogue/Digital/Analogue) .	
6	Selecting a channel	Press the ▲ or ▼ button, then press the ENTER button. Select the channel source to memorise. When setting the antenna source to Cable , a step appears allowing you to assign numerical values (channel frequencies) to the channels. For more information, refer to Channel → Auto Tuning . Press the ENTER button at any time to interrupt the memorisation process.	
7	Enjoy your TV.	Select the Watch TV . Press the ENTER button.  If you select the Network Settings , set the network. For more information, refer to "Network menu" in the e-Manual.	

If You Want to Reset This Feature...

Select **System - Plug & Play** (Initial Setup). Enter your 4 digit PIN number. The default PIN number is "0-0-0-0." If you want to change the PIN number, use the **Change PIN** function.

You should do **Plug & Play** (MENU → **System**) again at home although you did in shop.

 If you forget the PIN code, press the remote control buttons in the following sequence in Standby mode, which resets the PIN to "0-0-0-0" : MUTE → 8 → 2 → 4 → POWER (on)

Connecting to an AV devices

Available devices: DVD, Blu-ray player, HD cable box, HD STB (Set-Top-Box) satellite receiver, VCR, Digital Audio System, Amplifier, DVD Home Theatre, PC

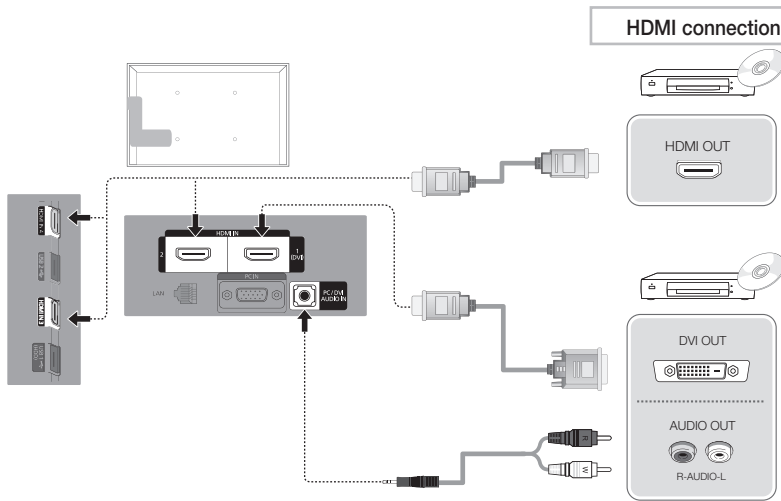

Using an HDMI cable or HDMI to DVI Cable (up to 1080p)

HDMI IN 1(DVI), 2, 3, 4, PC/DVI AUDIO IN

- For better picture and audio quality, connect to a digital device using an HDMI cable.
- An HDMI cable supports digital video and audio signals, and does not require an audio cable.
 - To connect the TV to a digital device that does not support HDMI output, use an HDMI/DVI and audio cables.
- The picture may not display normally (if at all) or the audio may not work if an external device that uses an older version of HDMI mode is connected to the TV. If such a problem occurs, ask the manufacturer of the external device about the HDMI version and, if out of date, request an upgrade.
- Be sure to purchase a certified HDMI cable. Otherwise, the picture may not display or a connection error may occur.
- A basic high-speed HDMI cable or one with ethernet is recommended. This product does not support the ethernet function via HDMI.

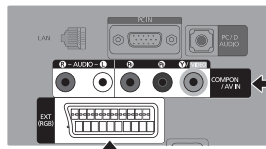

SCART connection

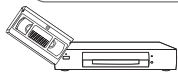
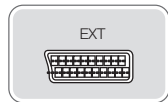

Component connection

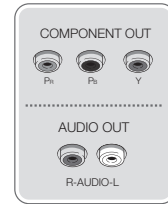
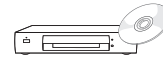

AV connection

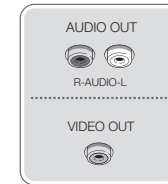
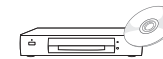

Using a Component (up to 1080p) or Audio/Video (480i only) and Scart Cable

- In **Ext.** mode, DTV Out supports MPEG SD Video and Audio only.
- To obtain the best picture quality, the Component connection is recommended over the A/V connection.

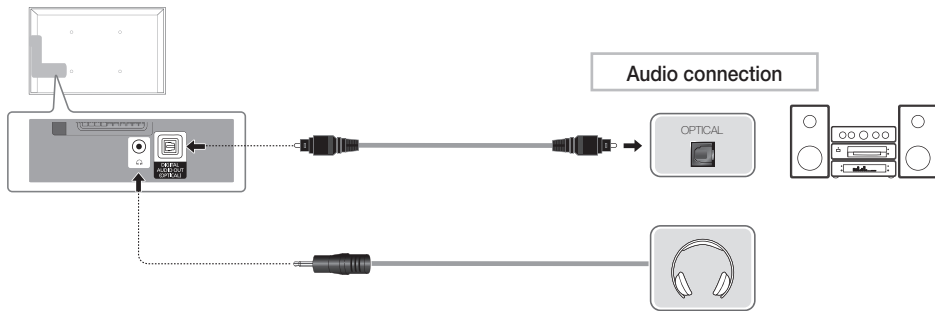

Available devices: Digital Audio System, Amplifier, DVD Home Theatre



Using an Optical (Digital) or Headphone Connection

DIGITAL AUDIO OUT (OPTICAL)

- When a digital audio system is connected to the **DIGITAL AUDIO OUT (OPTICAL)** jack, decrease the volume of both the TV and the system.
- 5.1 CH (channel) audio is available when the TV is connected to an external device supporting 5.1 CH.
- When the receiver (home theatre) is set to on, you can hear sound output from the TV's optical jack. When the TV is receiving a DTV signal, the TV will send 5.1 CH sound to the home theatre receiver. When the source is a digital component such as a DVD / Blu-ray player / cable box / STB (Set-Top-Box) satellite receiver and is connected to the TV via HDMI, only 2 CH audio will be heard from the home theatre receiver. If you want to hear 5.1 CH audio, connect the digital audio out jack from your DVD / Blu-ray player / cable box / STB satellite receiver directly to an amplifier or home theatre.

 **Headphones** : You can connect your headphones to the headphones output on your set. While the headphones are connected, the sound from the built-in speakers will be disabled.

- Sound function may be restricted when connecting headphones to the TV.
- Headphone volume and TV volume are adjusted separately.

Using an HDMI cable or HDMI to DVI Cable / a D-sub Cable

- ✎ Connecting through the HDMI cable may not be supported depending on the PC.
- ✎ An HDMI cable supports digital video and audio signals, and does not require an audio cable.

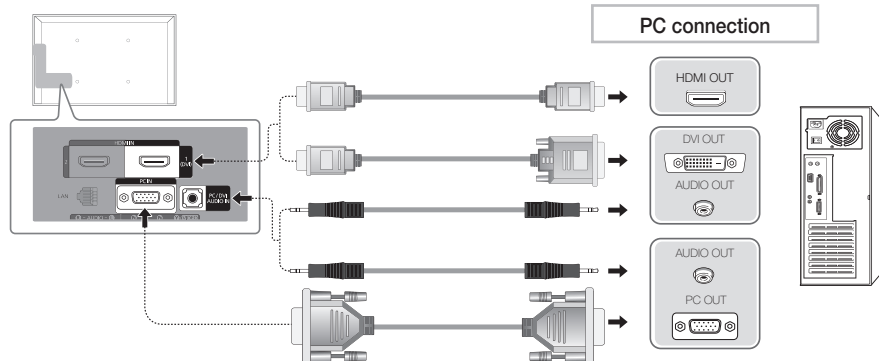

Display Modes (D-Sub and HDMI/DVI Input)

Optimal resolution is 1920 X 1080 @ 60 Hz.

Mode	Resolution	Horizontal Frequency (KHz)	Vertical Frequency (Hz)	Pixel Clock Frequency (MHz)	Sync Polarity (H / V)
IBM	640 x 350	31.469	70.086	25.175	+/-
	720 x 400	31.469	70.087	28.322	-/+
MAC	640 x 480	35.000	66.667	30.240	-/-
	832 x 624	49.726	74.551	57.284	-/-
	1152 x 870	68.681	75.062	100.000	-/-
VESA DMT	640 x 480	31.469	59.940	25.175	-/-
	640 x 480	37.861	72.809	31.500	-/-
	640 x 480	37.500	75.000	31.500	-/-
	800 x 600	37.879	60.317	40.000	+/+
	800 x 600	48.077	72.188	50.000	+/+
	800 x 600	46.875	75.000	49.500	+/+
	1024 x 768	48.363	60.004	65.000	-/-
	1024 x 768	56.476	70.069	75.000	-/-
	1024 x 768	60.023	75.029	78.750	+/+
	1152 x 864	67.500	75.000	108.000	+/+
	1280 x 1024	63.981	60.020	108.000	+/+
	1280 x 1024	79.976	75.025	135.000	+/+
	1280 x 800	49.702	59.810	83.500	-/+
	1280 x 800	62.795	74.934	106.500	-/+
	1280 x 960	60.000	60.000	108.000	+/+
	1360 x 768	47.712	60.015	85.500	+/+
	1440 x 900	55.935	59.887	106.500	-/+
1440 x 900	70.635	74.984	136.750	-/+	
1680 x 1050	65.290	59.954	146.250	-/+	
VESA DMT / DTV CEA	1920 x 1080p	67.500	60.000	148.500	+/+

NOTE





- For HDMI/DVI cable connection, you must use the HDMI IN 1(DVI) jack.
- The interlace mode is not supported.
- The set might operate abnormally if a non-standard video format is selected.
- Separate and Composite modes are supported. SOG(Sync On Green) is not supported.

Changing the Input Source

Source List

Use to select TV or other external input sources such as DVD / Blu-ray players / cable box / STB satellite receiver connected to the TV.

■ TV / Ext. / PC / AV / Component / HDMI1/DVI / HDMI2 / HDMI3 / HDMI4 / USB / AllShare

-  In the Source List, connected inputs will be highlighted.
-  If you want to see connected devices only, move to **Connected** using ◀ or ▶ button.
-  **Ext.** and **PC** always stay activated.
-  If the connected external devices are not highlighted, press the red button. The TV will search for connected devices.





Edit Name

How to use Edit Name

In the Source, press the TOOLS button, and then you can set an external input sources name you want.

■ VCR / DVD / Cable STB / Satellite STB / PVR STB / AV Receiver / Game / Camcorder / PC / DVI PC / DVI Devices / TV / IPTV / Blu-ray / HD DVD / DMA: Name the device connected to the input jacks to make your input source selection easier.

-  When connecting a PC to the **HDMI IN 1(DVI)** port with HDMI cable, you should set the TV to **PC** mode under **Edit Name**.
-  When connecting a PC to the **HDMI IN 1(DVI)** port with HDMI to DVI cable, you should set the TV to **DVI PC** mode under **Edit Name**.
-  When connecting an AV devices to the **HDMI IN 1(DVI)** port with HDMI to DVI cable, you should set the TV to **DVI Devices** mode under **Edit Name**.

Information

You can see detailed information about the selected external device.

Connecting to a COMMON INTERFACE slot

Using the "CI or CI+ CARD"

To watch paid channels, the "CI or CI+ CARD" must be inserted.

- If you do not insert the "CI or CI+ CARD," some channels will display the message "Scrambled Signal".
- The pairing information containing a telephone number, the "CI or CI+ CARD" ID the Host ID and other information will be displayed in about 2~3 minutes. If an error message is displayed, please contact your service provider.
- When the configuration of channel information has finished, the message "Updating Completed" is displayed, indicating the channel list is updated.

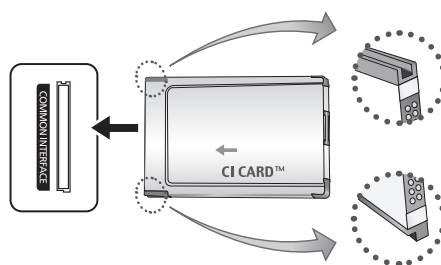

NOTE

- You must obtain a "CI or CI+ CARD" from a local cable service provider.
- When removing the "CI or CI+ CARD", carefully pull it out with your hands since dropping the "CI or CI+ CARD" may cause damage to it.
- Insert the "CI or CI+ CARD" in the direction marked on the card.
- The location of the **COMMON INTERFACE** slot may be different depending on the model.
- "CI or CI+ CARD" is not supported in some countries and regions; check with your authorized dealer.
- If you have any problems, please contact a service provider.
- Insert the "CI or CI+ CARD" that supports the current antenna settings. The screen will be distorted or will not be seen.

Network Connection

You can set up your TV so that it can access the Internet through your local area network (LAN) using a wired or wireless connection.

Network Connection - Wireless

You can connect your TV to your LAN through a standard wireless router or modem. To connect wirelessly, you must first attach a "Samsung Wireless LAN Adapter" (WIS09ABGN, WIS09ABGN2, WIS10ABGN - sold separately) to either the **USB** or **USB1 (HDD)**, **USB 2** port on the back of your TV. See the illustration below.

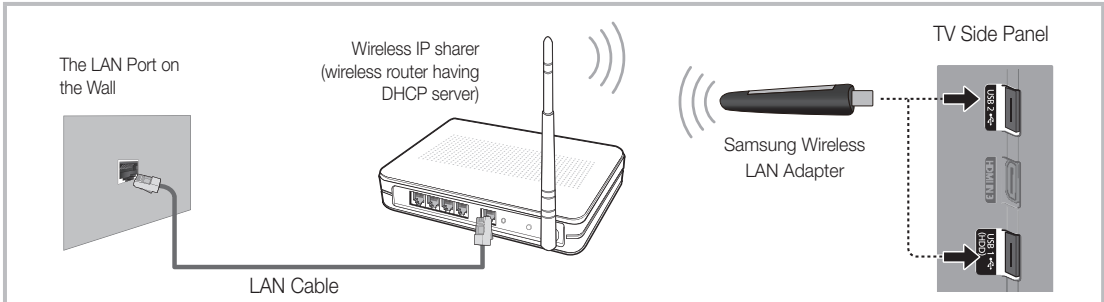

Samsung's Wireless LAN adapter is sold separately and is offered by select retailers, Ecommerce sites and Samsungparts.com. Samsung's Wireless LAN adapter supports the IEEE 802.11a/b/g and n communication protocols. Samsung recommends using IEEE 802.11n. When you play the video over a IEEE 802.11b/g connection, the video may not play smoothly.

Most wireless network systems incorporate a security system that requires devices that access the network through an access point or wireless router (typically a wireless IP Sharer) to transmit an encrypted security code called an access key.

If Pure High-throughput (Greenfield) 802.11n mode is selected and the Encryption type is set to WEP, TKIP or TKIP AES (WPS2Mixed) for your wireless router, Samsung TVs will not support a connection in compliance with new Wi-Fi certification specifications.

Network Connection - Wired

There are two main ways to connect your TV to your network using cable, depending on your network setup. They are illustrated below:

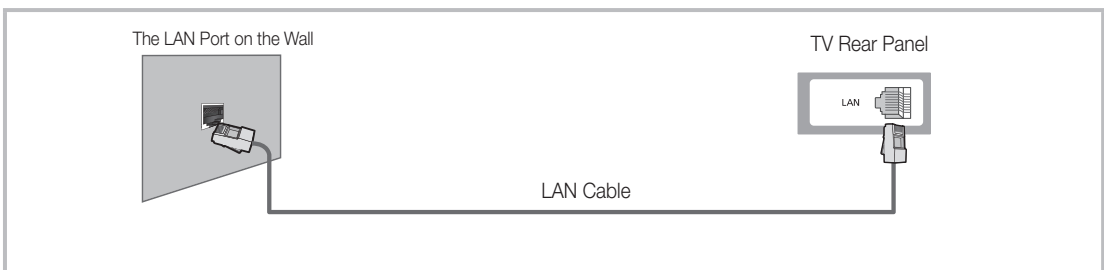
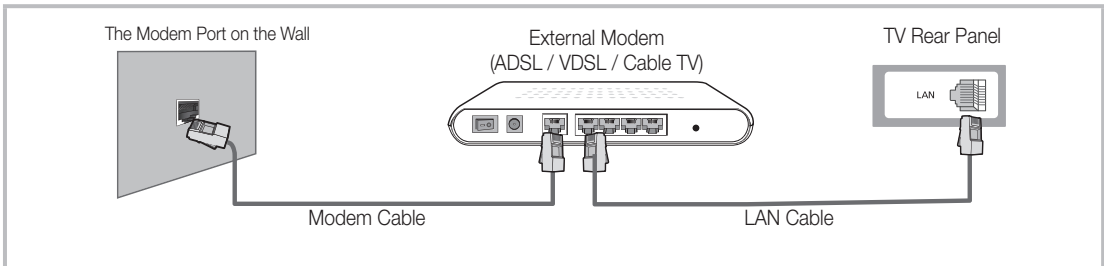

 A network speed of lower than 10 Mbps is not supported.

How to view the e-Manual



You can find instructions about your TV's features in the **e-Manual** in your TV. To use, press the **E-MANUAL** button on your remote. Move the cursor using the up/down/right/left buttons to highlight a category, then a topic, and then press the **ENTER** button. The e-Manual displays the page you want to see.

You can also access it through the menu:

MENU **Support** **e-Manual**

To return to the e-Manual main menu, press the E-MANUAL button on the remote.

You cannot use **Try now** directly if the TV is set to an external input source.

Screen Display

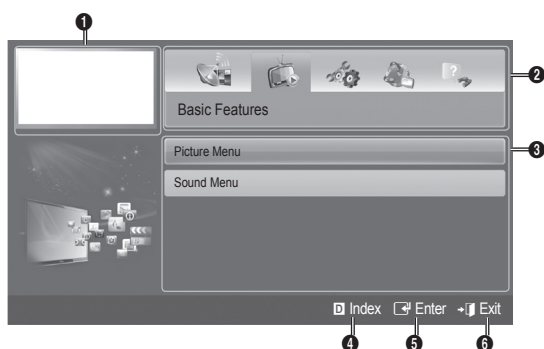

- 1 Currently displayed video, TV programme, etc.
- 2 The category list. Press or button to select the category you want.
- 3 Displays the sub-menu list. Use the arrow buttons on your remote to move the cursor. Press the **ENTER** button to select the sub-menu you want.
- 4 **Blue (Index)**: Displays the index screen.
- 5 **Enter**: Selects a category or sub-menu.
- 6 **Exit**: Exit the e-Manual.

How to toggle between an e-Manual topic and the corresponding OSD menu(s).

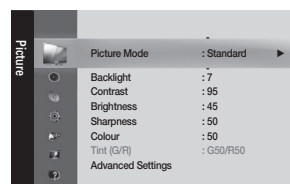
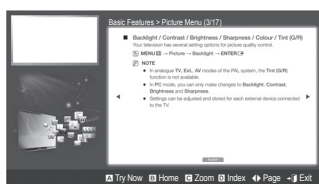

This function is not enabled in some menus

Method 1

1. If you want to use the menu that corresponds to an **e-Manual** topic, press the red button to select **Try Now**.
2. To return to the e-Manual screen, press the button.

Method 2

1. Press the **ENTER** button when a topic is displayed. "**Are you sure?**" appears. Select **Yes**, and then press the **ENTER** button. The OSD window appears.
2. To return to the **e-Manual** screen, press the **E-MANUAL** button.

Viewing the Contents

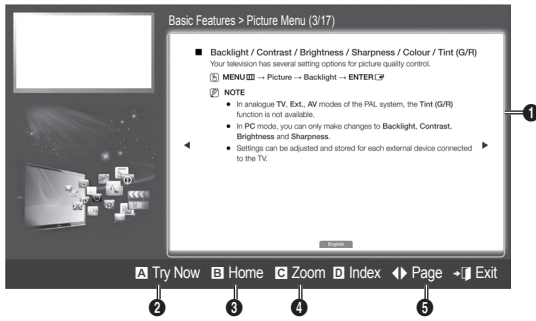

- 1 Contents Area: Contains the topic contents, if you selected a sub-menu. To move previous or next page, press the ◀ / ▶ button.
- 2 Try Now: Displays the OSD menu that corresponds to the topic. To return to the e-Manual screen, press the E-MANUAL button.
- 3 Home: Moves to the e-Manual home screen.
- 4 Zoom: Magnifies a screen. You can scroll through the magnified screen by using ▲ / ▼ buttons.
- 5 ◀ (Page): Moves to previous or next page.

Using the Zoom mode

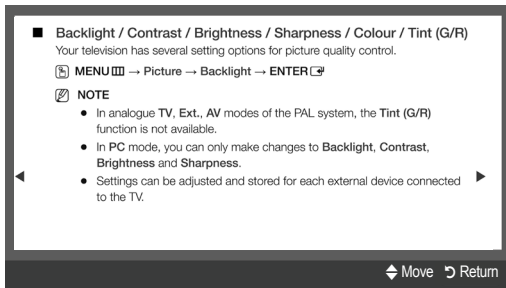

Select the **Zoom**, and then press ENTER to magnify the screen. You can scroll through the magnified screen by using the ▲ or ▼ buttons.

To return to the screen to normal size, press the RETURN button.

How to search for a topic on the index page

1. To search for a topic, press the left or right arrow button to select a letter, and then press ENTER. The Index displays a list of topics and keywords that begin with the letter you selected.
 2. Press the up or down arrow button to select a topic or keyword, and then press the ENTER button.
 3. The e-Manual page with the topic appears.
- To close the **Index** screen, press the RETURN button.

Installing the Wall Mount

The wall mount kit (sold separately) allows you to mount the TV on the wall.

For detailed information on installing the wall mount, see the instructions provided with the wall mount. Contact a technician for assistance when installing the wall mount bracket.

Samsung Electronics is not responsible for any damage to the product or injury to yourself or others if you elect to install the TV on your own.

Wall Mount Kit Specifications (VESA)

 Wall mount kit is not supplied but sold separately.

Install your wall mount on a solid wall perpendicular to the floor. When attaching to other building materials, please contact your nearest dealer. If installed on a ceiling or slanted wall, it may fall and result in severe personal injury.

NOTE

- Standard dimensions for wall mount kits are shown in the table below.
- When purchasing our wall mount kit, a detailed installation manual and all parts necessary for assembly are provided.
- Do not use screws that do not comply with the VESA standard screw specifications.
- Do not use screws longer than the standard dimension, as they may cause damage to the inside of the TV set.
- For wall mounts that do not comply with the VESA standard screw specifications, the length of the screws may differ depending on their specifications.
- Do not fasten the screws too strongly, this may damage the product or cause the product to fall, leading to personal injury. Samsung is not liable for these kinds of accidents.
- Samsung is not liable for product damage or personal injury when a non-VESA or non-specified wall mount is used or the consumer fails to follow the product installation instructions.
- Do not exceed 15 degrees tilt when mounting this TV.

Product Family	inches	VESA Spec. (A * B)	Standard Screw	Quantity
LCD-TV	19~26	75 X 75 200 X 100	M4	4
	32~40	200 X 200	M6	
	46	400 X 400	M8	

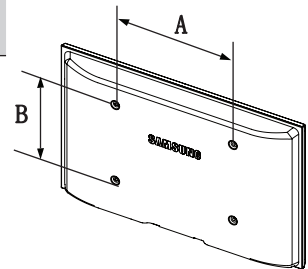

Do not install your Wall Mount Kit while your TV is turned on. It may result in personal injury due to electric shock.

Troubleshooting

If the TV seems to have a problem, first try this list of possible problems and solutions. If none of these troubleshooting tips apply, visit "www.samsung.com," then click on Support, or call Samsung customer service.

Issues	Solutions and Explanations
The TV will not turn on.	<ul style="list-style-type: none"> Make sure the AC power cord is securely plugged in to the wall outlet and the TV. Make sure the wall outlet is working. Try pressing the POWER button on the TV to make sure the problem is not the remote. If the TV turns on, refer to "Remote control does not work" below.
There is no picture/video.	<ul style="list-style-type: none"> Check cable connections (remove and reconnect all cables connected to the TV and external devices). Set your external device's (Cable/Set top box, DVD, Blu-ray etc) video outputs to match the connections to the TV input. For example, if an external device's output is HDMI, it should be connected to an HDMI input on the TV. Make sure your connected devices are powered on. Be sure to select the TV's correct source by pressing the SOURCE button on the remote control. Reboot the connected device by reconnecting the device's power cable.
The remote control does not work.	<ul style="list-style-type: none"> Replace the remote control batteries with the poles (+/-) in the right direction. Clean the sensor's transmission window on the remote. Try pointing the remote directly at the TV from 5-6 feet away.
The cable/set top box remote control doesn't turn the TV on or off, or adjust the volume.	<ul style="list-style-type: none"> Program the Cable/Set top box remote control to operate the TV. Refer to the Cable/Set top box user manual for the SAMSUNG TV code.

You can keep your TV as optimum condition to upgrade the latest firmware on web site (samsung.com -> Support -> Downloads) by USB.

This TFT LCD panel uses a panel consisting of sub pixels which require sophisticated technology to produce. However, there may be a few bright or dark pixels on the screen. These pixels will have no impact on the performance of the product.

Licence



List of Features

Excellent Digital Interface & Networking: With a built-in HD digital tuner, nonsubscription HD broadcasts can be viewed without a cable box / STB (Set-Top-Box) satellite receiver.

My Downloads

Allows you to play music files, pictures, and movies saved on a USB device.

AllShare™

AllShare™ connects your TV and compatible Samsung mobile phones/devices through a network.

Anynet+(HDMI-CEC)

Allows you to control all connected Samsung devices that support Anynet+ with your Samsung TV's remote.

Securing the TV to the Wall



Caution: Pulling, pushing, or climbing onto the TV may cause the TV to fall. In particular, ensure that your children do not hang over or destabilize the TV; doing so may cause the TV to tip over, resulting in serious injuries or death. Follow all safety precautions provided on the included Safety Flyer. For added stability, install the anti-fall device for safety purposes, as follows.

To avoid the TV from falling

1. Put the screws into the clamps and firmly fasten them onto the wall. Confirm that the screws have been firmly installed onto the wall.

- You may need additional material such as an anchor depending on the type of wall.
- Since the necessary clamps, screws, and string are not supplied, please purchase these additionally.

2. Remove the screws from the centre back of the TV, put the screws into the clamps, and then fasten the screws onto the TV again.

- Screws may not be supplied with the product. In this case, please purchase the screws of the following specifications.

Screw Specifications

- For a 32 ~ 40 Inch LCD TV: M6
- For a 46 ~ 55 inch LCD TV: M8

3. Connect the clamps fixed onto the TV and the clamps fixed onto the wall with a strong string and then tie the string tightly.

NOTE

- Install the TV near to the wall so that it does not fall backwards.
- It is safe to connect the string so that the clamps fixed on the wall are equal to or lower than the clamps fixed on the TV.
- Untie the string before moving the TV.

4. Verify all connections are properly secured. Periodically check connections for any sign of fatigue for failure. If you have any doubt about the security of your connections, contact a professional installer.

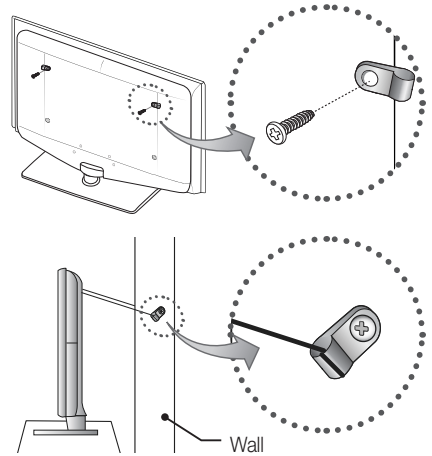

Storage and Maintenance

- If you remove the attached sticker on the TV screen, clean the residues and then watch TV.

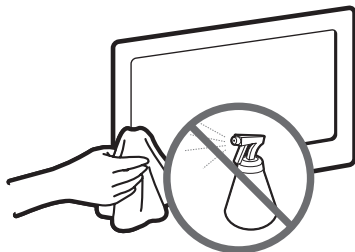

Do not spray water or a cleaning agent directly onto the product. Any liquid that goes into the product may cause a failure, fire, or electric shock.

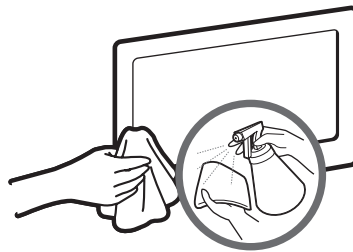

Clean the product with a soft cloth dipped in a small amount of water.

Specifications

Display Resolution	1920 x 1080			
Environmental Considerations				
Operating Temperature	10°C to 40°C (50°F to 104°F)			
Operating Humidity	10% to 80%, non-condensing			
Storage Temperature	-20°C to 45°C (-4°F to 113°F)			
Storage Humidity	5% to 95%, non-condensing			
TV System	Analogue: B/G, D/K, L, I (Depending on your country selection) Digital: DVB-T/DVB-C			
Colour/Video System	Analogue: PAL, SECAM, NTSC-4.43, NTSC-3.58, PAL60 Digital: MPEG-2 MP@ML, MPEG-4, H.264/AVC MP@L3, MP@L4.0, HP@L4.0			
Sound System	BG, DK, L, NICAM, MPEG1, DD, DD+, HEAAC			
HDMI IN 1 ~ 4	Video: 1080 24p, 1080p, 1080i, 720p, 576p, 576i, 480p, 480i Audio: 2Ch Linear PCM 32/44.1/48kHz, 16/20/24bits.			
Stand Swivel (Left / Right)	-20° ~ 20°			
Model Name	LE32D550 / LE32D551	LE37D550 / LE37D551	LE40D550 / LE37D551	LE46D550 / LE37D551
Screen Size	32 inches	37 inches	40 inches	46 inches
Sound (Output)	10 W X 2			
Dimensions (WxDxH)				
Body	804.7 X 80.3 X 507.4 (mm)	923.5 X 78.5 X 573.2 (mm)	992.1 X 80.4 X 611.0 (mm)	1124.1 X 80.4 X 686.1 (mm)
With stand	804.7 X 240.0 X 563.7 (mm)	923.5 X 255.0 X 629.2 (mm)	992.1 X 255.0 X 667.2 (mm)	1124.1 X 275.0 X 742.8 (mm)
Weight				
Without Stand	9.1 kg	12.6 kg	14.3 kg	19.4 kg
With Stand	11.8 kg	15.8 kg	17.5 kg	23.0 kg
Model Name	LE32D580	LE37D580	LE40D580	LE46D580
Screen Size	32 inches	37 inches	40 inches	46 inches
TV System	Analogue: B/G, D/K, L, I (Depending on your country selection) Digital: DVB-T/DVB-C/DVB-T2			
Sound (Output)	10 W X 2			
Dimensions (WxDxH)				
Body	804.7 X 80.3 X 507.4 (mm)	923.5 X 78.5 X 573.2 (mm)	992.1 X 80.4 X 611.0 (mm)	1124.1 X 80.4 X 686.1 (mm)
With stand	804.7 X 240.0 X 563.7 (mm)	923.5 X 255.0 X 629.2 (mm)	992.1 X 255.0 X 667.2 (mm)	1124.1 X 275.0 X 742.8 (mm)
Weight				
Without Stand	9.1 kg	12.6 kg	14.3 kg	19.4 kg
With Stand	11.8 kg	15.8 kg	17.5 kg	23.0 kg

 Design and specifications are subject to change without prior notice.

 For information about power supply, and more about power consumption, refer to the label attached to the product.

Warning! Important Safety Instructions

Please read the appropriate section that corresponds to the marking on your Samsung product before attempting to install the product.

CAUTION

RISK OF ELECTRIC SHOCK DO NOT OPEN

CAUTION: TO REDUCE THE RISK OF ELECTRIC SHOCK, DO NOT REMOVE COVER (OR BACK). THERE ARE NO USER SERVICEABLE PARTS INSIDE. REFER ALL SERVICING TO QUALIFIED PERSONNEL.



This symbol indicates that high voltage is present inside. It is dangerous to make any kind of contact with any internal part of this product.



This symbol alerts you that important literature concerning operation and maintenance has been included with this product.

- The slots and openings in the cabinet and in the back or bottom are provided for necessary ventilation. To ensure reliable operation of this apparatus, and to protect it from overheating, these slots and openings must never be blocked or covered.
 - Do not cover the slots and openings with a cloth or other materials.
 - Do not block the slots and openings by placing this apparatus on a bed, sofa, rug or other similar surface.
 - Do not place this apparatus in a confined space, such as a bookcase, or built-in cabinet, unless proper ventilation is provided.
 - Give your product 10 cm (4 inch) clearance from the wall.
- Do not place this apparatus near or over a radiator or heat resistor, or where it is exposed to direct sunlight.
- Do not place heat generating items such as candles, ashtrays, incense, flammable gas or explosive materials near the product.
- Do not place a water containing vessel on this apparatus, as this can result in a risk of fire or electric shock.
- Do not expose this apparatus to rain or place it near water (near a bathtub, washbowl, kitchen sink, or laundry tub, in a wet basement, or near a swimming pool etc.). If this apparatus accidentally gets wet, unplug it and contact an authorized dealer immediately. Make sure to pull out the power cord from the outlet before cleaning.
- This apparatus use batteries. In your community there might be regulations that require you to dispose of these batteries properly under environmental considerations. Please contact your local authorities for disposal or recycling information.
- Do not overload wall outlets, extension cords or adaptors beyond their capacity, since this can result in fire or electric shock.
- Power-supply cords should be routed so that they are not likely to be walked on or pinched by items placed upon or against them, paying particular attention to cords at plug end, adaptors and the point where they exit from the appliance.
- To protect this apparatus from a lightning storm, or when it is left unattended and unused for long periods of time, unplug it from the wall outlet and disconnect the antenna or cable system.
This will prevent damage to the set due to lightning and power line surges.
- Before connecting the AC power cord to the DC adaptor outlet, make sure the voltage designation of the DC adaptor corresponds to the local electrical supply.
- Never insert anything metallic into the open parts of this apparatus. Doing so may create a danger of electric shock.
- To avoid electric shock, never touch the inside of this apparatus. Only a qualified technician should open this apparatus.
- Make sure to plug the power cord in until it is firmly inserted. When removing the power cord, make sure to hold the power plug when pulling the plug from the outlet. Do not touch the power cord with wet hands.
- If this apparatus does not operate normally - in particular, if there are any unusual sounds or smells coming from it
 - unplug it immediately and contact an authorized dealer or service center.
- Be sure to pull the power plug out of the outlet if the TV is to remain unused or if you are to leave the house for an extended period of time (especially when children, elderly or disabled people will be left alone in the house).
 - Accumulated dust can cause an electric shock, an electric leakage or a fire by causing the power cord to generate sparks and heat or the insulation to deteriorate.
- Be sure to contact an authorized service center, when installing your set in a location with heavy dust, high or low temperatures, high humidity, chemical substances and where it operates for 24 hours such as the airport, the train station etc. Failure to do so may cause serious damage to your set.
- Use only a properly grounded plug and receptacle.
 - An improper ground may cause electric shock or equipment damage. (Class I Equipment only.)
- To disconnect the apparatus from the mains, the plug must be pulled out from the mains socket, therefore the mains plug shall be readily operable.
- Do not allow children to hang onto the product.
- Store the accessories (battery, etc.) in a location safely out of the reach of children.
- Do not install the product in an unstable location such as a shaky shelf, a slanted floor or a location exposed to vibration.
- Do not drop or impart any shock to the product. If the product is damaged, disconnect the power cord and contact a service center.



**WARNING - TO PREVENT THE SPREAD OF FIRE,
KEEP CANDLES OR OTHER OPEN FLAMES AWAY
FROM THIS PRODUCT AT ALL TIMES.**

Wiring the Mains Power Supply Plug (UK Only)

IMPORTANT NOTICE

The mains lead on this equipment is supplied with a moulded plug incorporating a fuse. The value of the fuse is indicated on the pin face of the plug and, if it requires replacing, a fuse approved to BSI1362 of the same rating must be used.

Never use the plug with the fuse cover omitted if the cover is detachable. If a replacement fuse cover is required, it must be of the same colour as the pin face of the plug. Replacement covers are available from your dealer.

If the fitted plug is not suitable for the power points in your house or the cable is not long enough to reach a power point, you should obtain a suitably approved extension lead or consult your dealer for assistance. However, if there is no alternative but to cut off the plug, remove the fuse and then safely dispose of the plug.

Do NOT connect the plug to a mains socket as there is a risk of shock hazard from the bared flexible cord.

IMPORTANT

The wires in the mains lead are coloured in accordance with the following code:

BLUE - NEUTRAL BROWN - LIVE

As these colours may not correspond to the coloured markings identifying the terminals in your plug, proceed as follows :

The wire coloured BLUE must be connected to the terminal marked with the letter N or coloured BLUE or BLACK.

The wire coloured BROWN must be connected to the terminal marked with the letter L or coloured BROWN or RED.

WARNING:

DO NOT CONNECT EITHER WIRE TO THE EARTH TERMINAL, WHICH IS MARKED WITH THE LETTER E OR BY THE EARTH SYMBOL , OR COLOURED GREEN OR GREEN AND YELLOW.

Warranty Card



UNITED KINGDOM

This Samsung product is warranted for a period of twelve (12) months from the original date of purchase, against defective materials and workmanship. In the event that warranty service is required, you should return the product to the retailer from whom it was purchased. However, Samsung Authorised Dealers and Authorised Service Centres in other EC Countries will comply with the warranty on the terms issued to purchasers in the country concerned. In case of difficulty, details of our Authorised Service Centres are available from:

Samsung Electronics U.K. Ltd.

Customer Care Centre

PO Box 17243

Edinburgh, EH11 4YB

United Kingdom

Tel: 0870 SAMSUNG (7267864)(UK & Northern Ireland)

Tel: 0818 717 100 (EIRE Only)

Fax: +44 0845 650 8080

Web : www.samsung.com

WARRANTY CONDITIONS

1. The warranty is only valid if, when warranty service is required, the warranty card is fully and properly completed and is presented with the original invoice or sales slip or confirmation, and the serial number on the product has not been defaced.
2. Samsung's obligations are limited to the repair or, at its discretion, replacement of the product or the defective part.
3. Warranty repairs must be carried out by Authorised Samsung Dealers or Authorised Service Centres.
No re-imbusement will be made for repairs carried out by non Samsung Dealers and, any such repair work and damage to the products caused by such repair work will not be covered by this warranty.
4. This product is not considered to be defective in materials nor workmanship by reason that it requires adaptation in order to conform to national or local technical or safety standards in force in any Country other than the one for which the product was originally designed and manufactured.



Contact SAMSUNG WORLDWIDE

If you have any questions or comments relating to Samsung products, please contact the SAMSUNG customer care centre.

Country	Customer Care Centre 	Web Site
EIRE	0818 717 100	www.samsung.com
U.K	0330 SAMSUNG (7267864)	www.samsung.com



Free Manuals Download Website

<http://myh66.com>

<http://usermanuals.us>

<http://www.somanuals.com>

<http://www.4manuals.cc>

<http://www.manual-lib.com>

<http://www.404manual.com>

<http://www.luxmanual.com>

<http://aubethermostatmanual.com>

Golf course search by state

<http://golfingnear.com>

Email search by domain

<http://emailbydomain.com>

Auto manuals search

<http://auto.somanuals.com>

TV manuals search

<http://tv.somanuals.com>