



SAMSUNG

LCD-Monitor

Chassis LHU30BS
Model 305TPLUS

SERVICE Manual

LCD Monitor



Fashion Feature

- Back Side cable management
- Slim / Narrow Design
- PCB: 2 Layer, 150mm x 100mm
- Connectivity: DVI-D, USB 2.0 (1up, 4down)
- Power consumption: 130W
- Built in power supply



-This Service Manual is a property of Samsung Electronics Co., Ltd.
Any unauthorized use of Manual can be punished under applicable International and/or domestic law.

Samsung Electronics Co.,Ltd.
416, Maetan-3Dong, Yeongtong-Gu, Suwon City,
Gyeonggi-Do, Korea, 443-742
Printed in Korea
P/N : BN82-00169A-01
URL : <http://itself.sec.samsung.co.kr/>

3 Alignments and Adjustments

This section of the service manual explains how to use the RS232 JIG.

This function is needed for AD board change and program memory (IC200) change.

3-1 Required Equipment

The following equipment is necessary for adjusting the monitor:

Computer with Windows 95, Windows 98, or Windows NT.

MTI-2055 DDC MANAGER JIG

3-2 DDC EDID Data Input

1. Input DDC EDID data when replacing AD PCB.
2. Receive/Download the proper DDC file for the model from HQ quality control department.
Install the below jig (Figure 1) and enter the data.

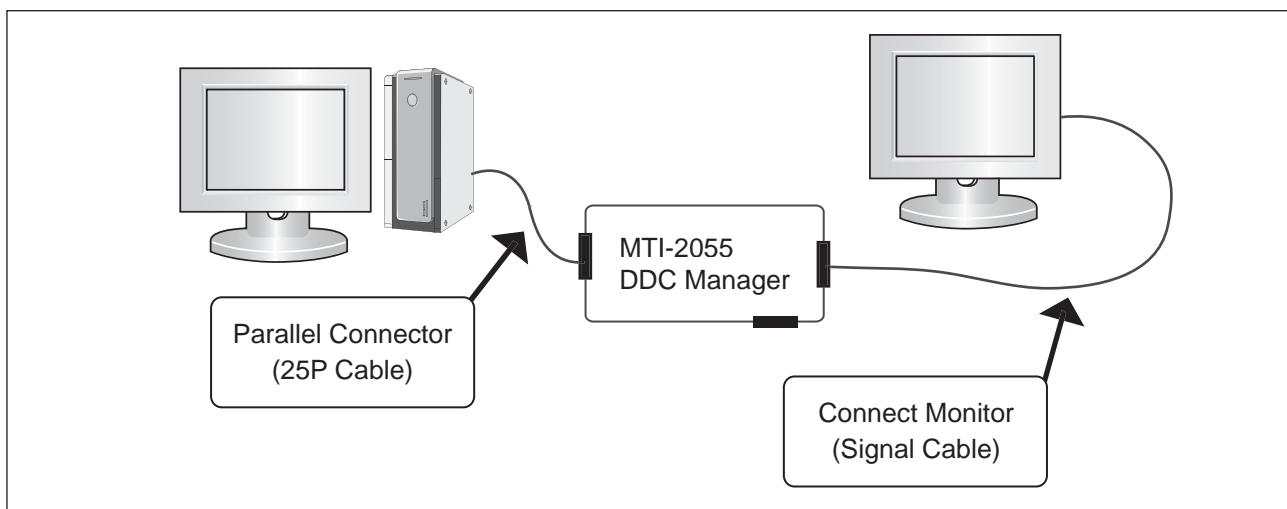
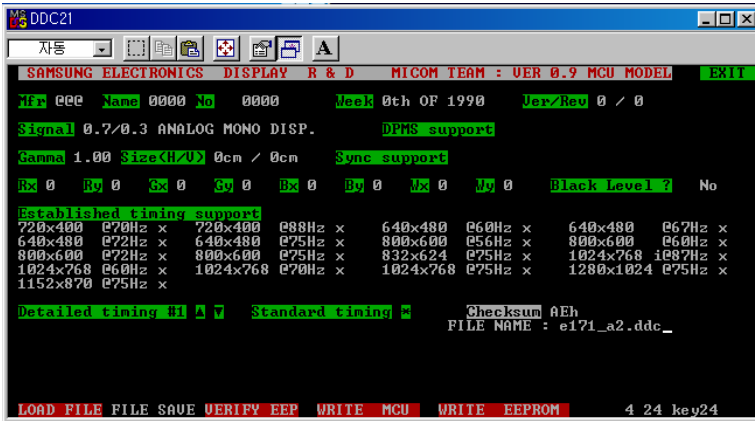

Figure 1.

3-3 Hidden Key list

No	Function	Operating method
1	USB ID data down load from MICOM	Turns off soft power swith and presses BRT down button more then 3 seconds "LED Blinking"

3-4 EDID Installation with Dos Program



1. Execute "DDC21.exe"±

2. Click "LOAD FILE"±

3. File Name "305T.DDC"

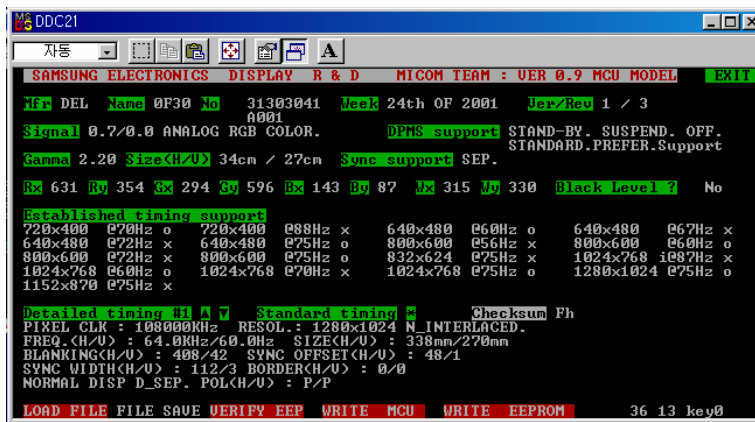

4. Click "WRITE EEPROM"±

Confirm the "OK" Sign

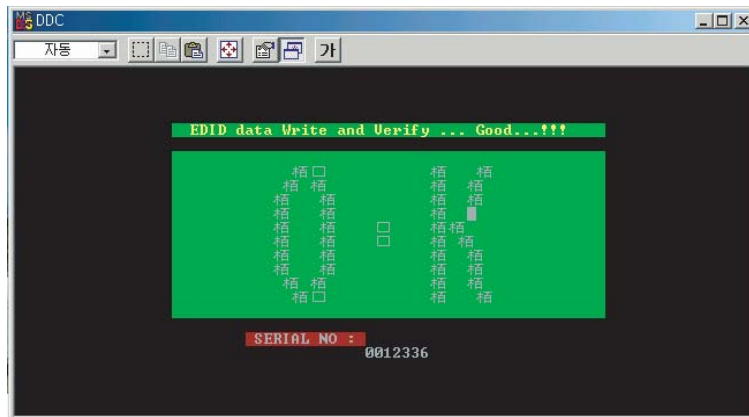

Error Message: Check the Signal Cable or Interface Board

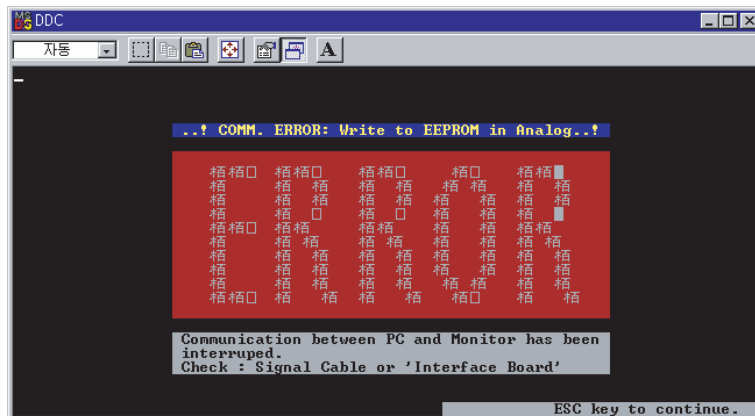

3-5 EDID Installation with Windows Program

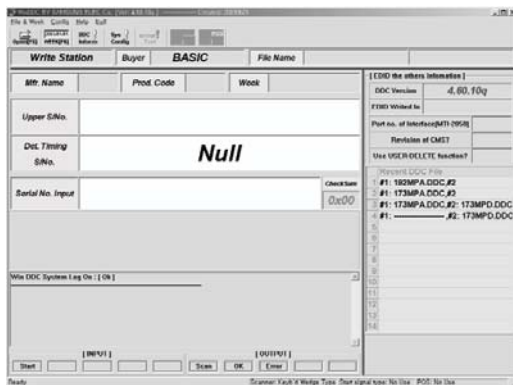

1. Execute "WinDDC.exe"

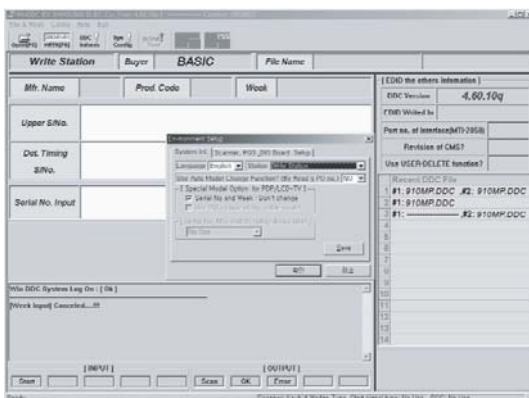

2. Click "Sys Config"±
Select "Station : Write station".
Check "Serial No and Week : Don't change"±
Click "Save"±

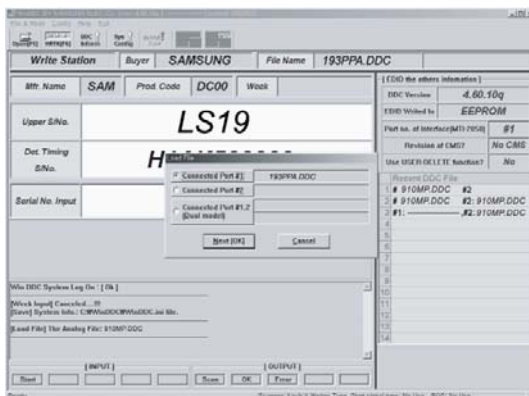

3. Click "Open" icon.
Select "Connected Port #1" and Next "OK".
* File Name - 305T.DDC
Press enter key on your keyboard.



4. Confirm the "DDC OK".

- After Replacing the Main Board

-EDID Installation (Analog and Digital)

-Factory Reset(Using Power key)

During Power off, press Power key for 5 seconds.

With 1 beep sound, Factory Reset executes.

3 Alignments and Adjustments

Memo

7 Block Diagram

7-1 Block Diagram (Main)

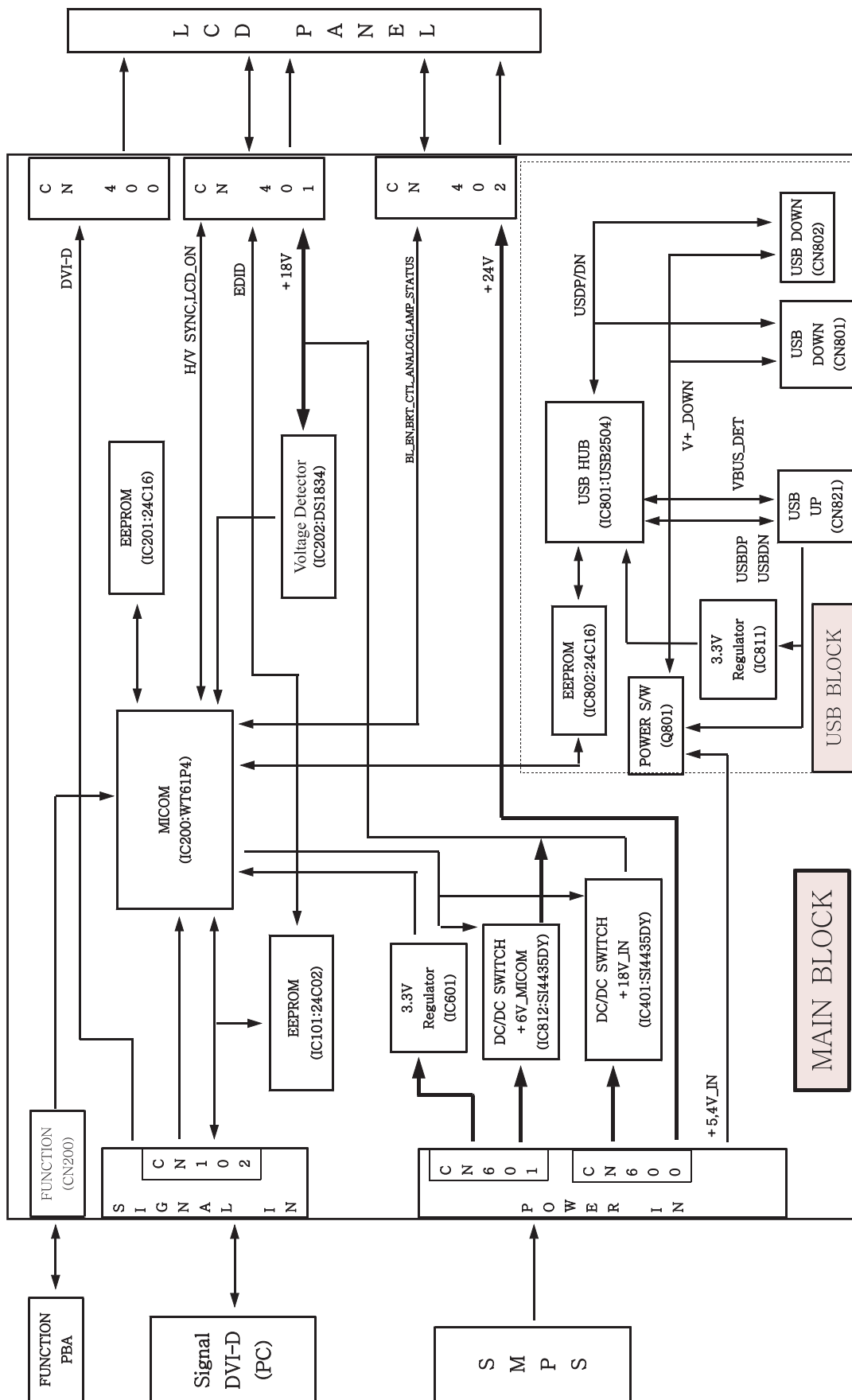

7-2 Block Diagram (SMPS)

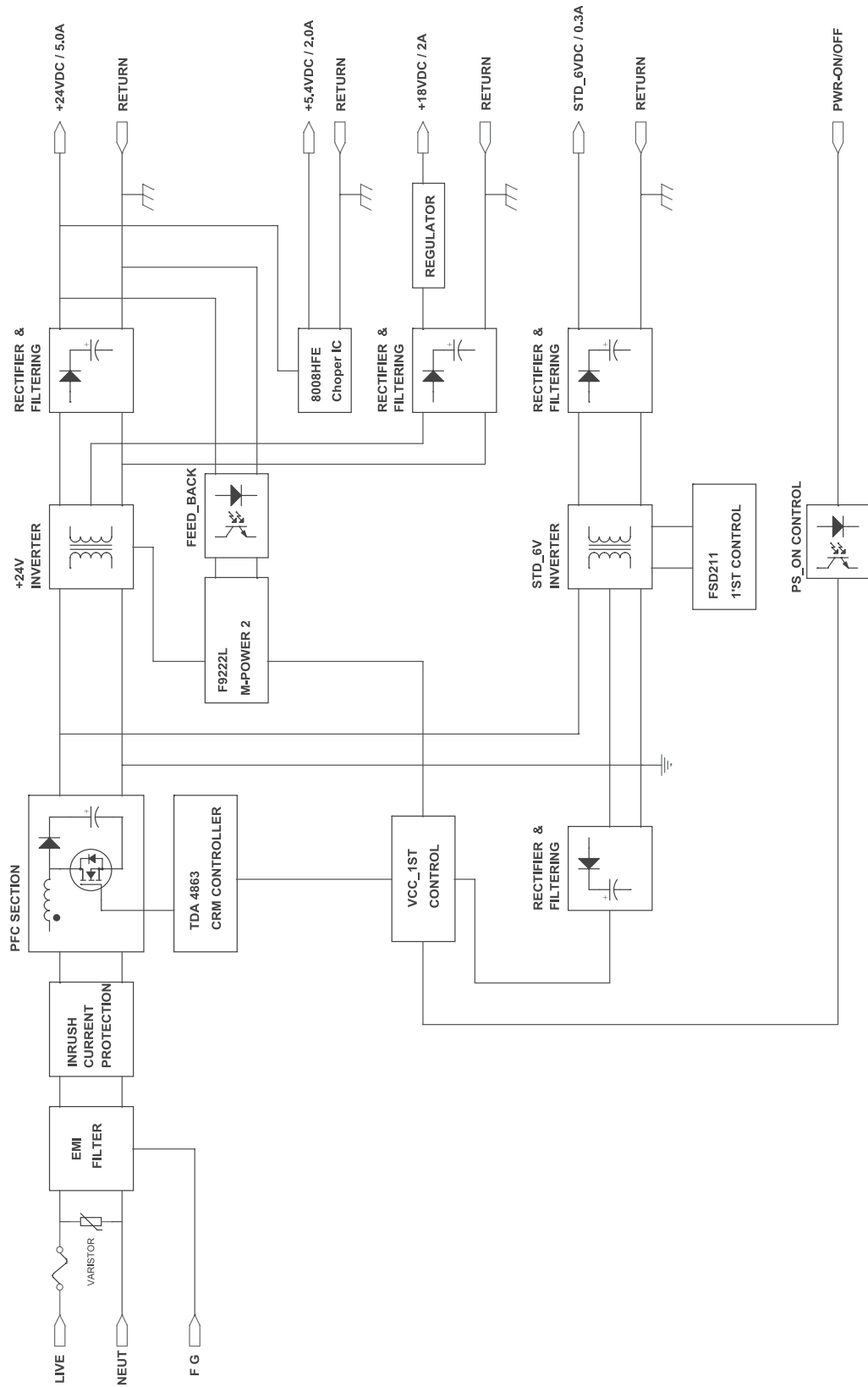

13 Circuit Descriptions

13-1 BLOCK discription (MAIN)

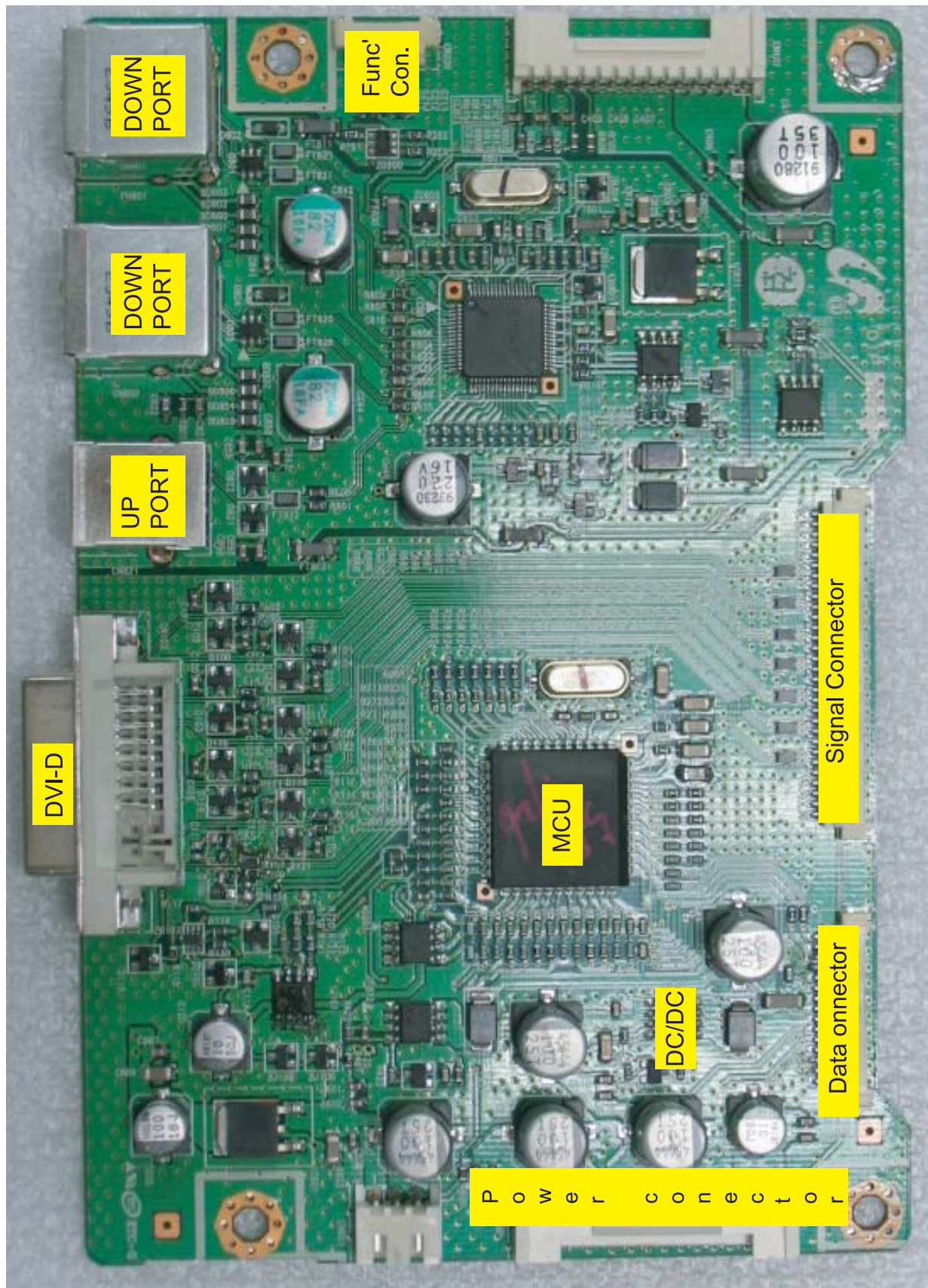

13 Circuit Descriptions

No	BLOCK	DESCRIPTION	NAME
1	MICOM	IC-MICROCONTROLLER,PLCC,44P,16Bit	WT61P4
2	USB	IC-USC, USB2504,8Bit,TQFP,64P	USB2504
3	DC/DC	FET-SILICON, SI4435DY,P,-30V,+8.0A, 0.014ohm,2.5W,SO-8	SI4435
4	DVI-D INPUT	CN_DSUB_24_3R_G2, CONNECTOR-DVI, 24P,3R,FEMALE,ANGLE,AUF	CONNECTOR-DVI
5	USB PORT	JACK_USB_08_G4, JACK-USB, 4P/2C,AUF, BLK,ANGLE,A TYPE	USB_DN
6	USB PORT	JACK_USB_04_G2, JACK-USB, 4P/1C,AU,IVR, ANGLE,B TYPE	USB_UP
7	SIGNAL CONNECTOR	CN_SMD_S_030, CONNECTOR-HEADER, BOX,30P,1R,1.25mm,SMD-A,Sn+Pb,IVR	LVDS CONNECTOR
8	DATA CONNECTOR	CN_S_015_G2, CONNECTOR-HEADER, BOX,15P,1R,1.25mm,SMD-A,SnPb,IVR	DATA CONNECTOR
9	POWER CONNECTOR	CN_S_016, HEADER-BOARD TO CABLE, BOX,16P,1R,2mm,ANGLE,SN,IVORY	POWER CONNECTOR
10	FUNCTION CONNECTOR	CN_S_006_G2, CONNECTOR-HEADER, BOX,6P,1R,1.25mm,SMD-A,SnPb,IVR	FUNCTION
11	inverter connector	CN_S_014,HEADER-BOARD TO CABLE, BOX,14P,1R,2mm,ANGLE,SN,IVORY	INVERTER CONNECTOR

13-2 BLOCK discription (SMPS)

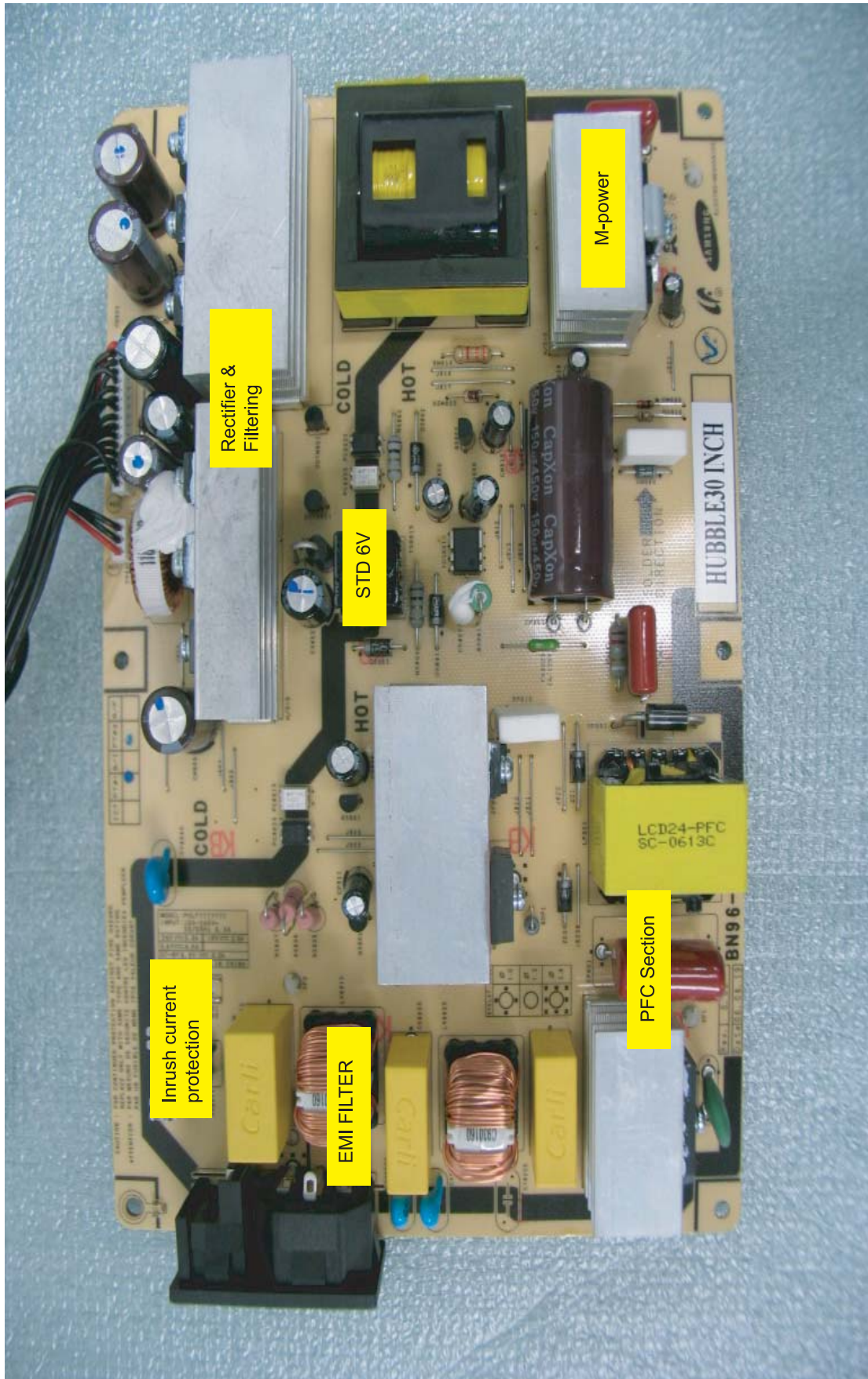

13 Circuit Descriptions

No	BLOCK	DESCRIPTION	NAME
1	EMI Filter	Coil Line filter	LX801s
2	Inrush current	For continued protection	FP801S
3	PFC section	Power Factor Correction (PFC) allows power distribution to operate at its maximum efficiency	PFC Circuit
4	M-power	Multiple-chip power Device	F9222L
5	STD 6V	Standby power is the power consumed by an appliance during the lowest possible electricity consuming mode	Standby power
6	Rectifier & Filtering	Rectification is the conversion of alternating current (AC) to direct current (DC).	



11 Disassembly and Reassembly



This section of the service manual describes the disassembly and reassembly procedures for the 305TLCD monitor.

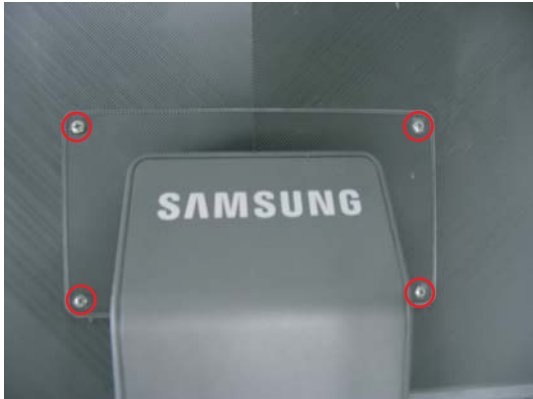

⚠ WARNING: This monitor contains electrostatically sensitive devices. Use caution when handling these components.

11-1 Disassembly

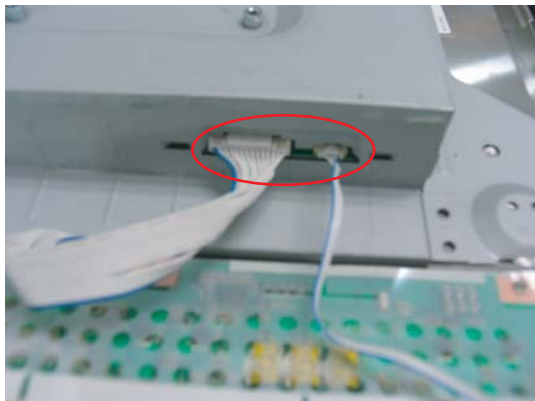
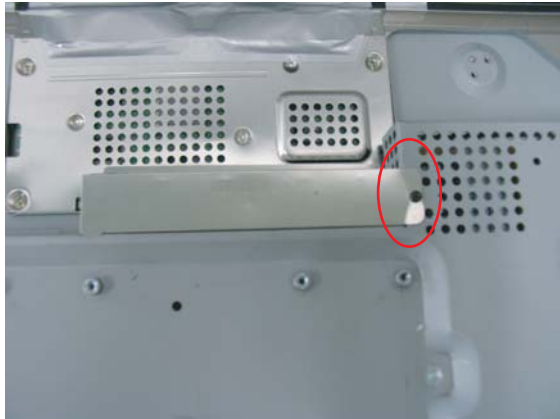
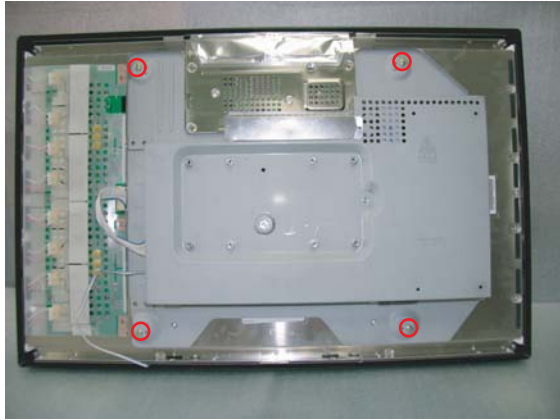
⚠ Cautions: 1. Disconnect the monitor from the power source before disassembly.

Description	Picture Description
<p>1. Place monitor face down on cushioned table. Remove 4 screws and lift up the Stand ass'y</p>	
<p>2. Lift up the stand cover from front cover</p>	

Description	Picture Description
<p>3. Disconnect cables and remove the inverter power and function cable</p>	
<p>4. Remove 1screws from the Shield.</p>	
<p>5. Remove 4screws from the Shield between LCD_ppanel and Shield</p>	
<p>6. Disconnect cables LVDS and Signal from Panel control board</p>	

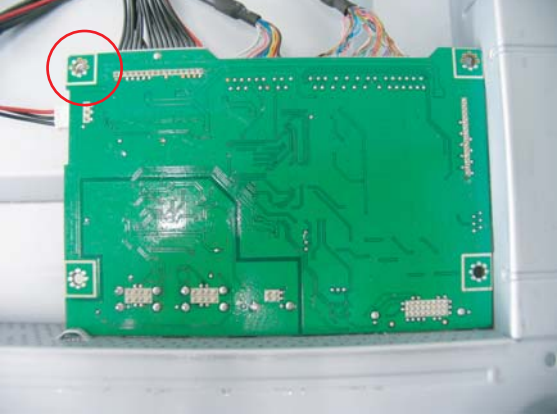
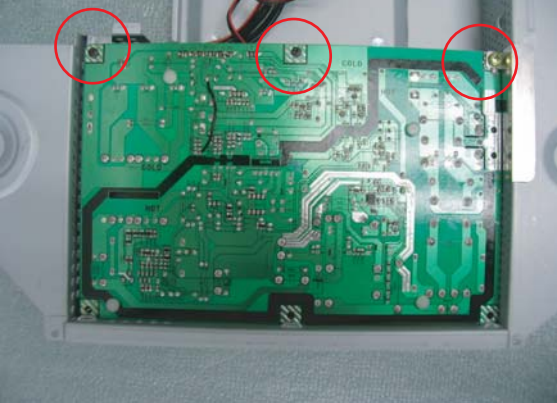
Description	Picture Description
7. Remove 2 screws from DVI input connector	
8. Up and down the chassis ass'y	
9. Remove 2 screw on the main board	
10. Remove 3 screws on the SMPS board	

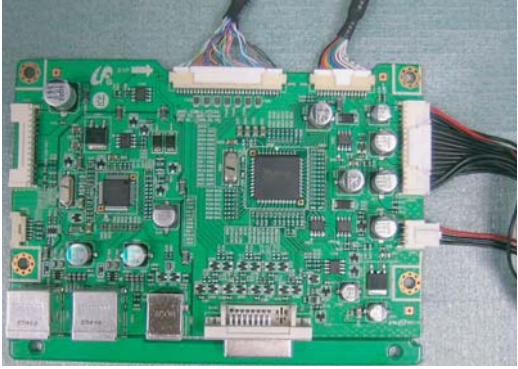
Description	Picture Description
11.Disconnect cables LVDS and Signal and Power from Main board	

11-3 Reassembly

Reassembly procedures are in the reverse order of disassembly procedures.

6 Electrical Parts List

-You can search for updated part codes through ITSELF web site.

URL : <http://itself.sec.samsung.co.kr/>

6-1. LS30HUXCB/XSF Parts List

Level	Loc. No.	Code No.	Description & Specification	Q'ty	SA/SNA
		LS30HUXCB/XSF	305TPLUS,WQA1/S30A0-LHU,30,LCD-MO,CHINA		
0.1	M0001	BN90-01014G	ASSY COVER FRONT;LS30HUX_305T PLUS	1	S.N.A
.2	T0003	BN96-03652F	ASSY COVER P-FRONT;LS30HUX(305T PLUS),,H	1	S.A
...3	M0112	BN63-02663D	COVER-FRONT;LS30HUX (305T PLUS),HIPS HB	1	S.N.A
...3	T0022	BN64-00504A	KNOB-CONTROL;HUBBLE,HIPS HB,T2.0,UT-0510	1	S.N.A
...3	T0054	BN64-00505A	KNOB-DECORATION;HUBBLE,ABS HB,T2.0,NATUR	1	S.N.A
...3	M0145	BN96-04050A	ASSY BOARD P-FUNCTION;HUBBLE,SJ06-01-013	1	S.A
.2	T0382	BP61-00495C	HOLDER-CARE;PJT,ACRYL-FOAM,T0.25,W30.0mm	0.2	S.N.A
0.1	M0002	BN90-01015A	ASSY COVER REAR;LS30HUBCB/XAA	1	S.N.A
.2	M0013	BN96-03991A	ASSY COVER P-REAR;HUBBLE,,HIPS HB,,BK26,	1	S.A
...3	M0006	BN63-02664A	COVER-REAR;HUBBLE,HIPS HB,3.2,BK26	1	S.N.A
0.1	M0216	BN90-01194C	ASSY STAND;LS30HU	1	S.N.A
.2	M0003	BN96-04718B	ASSY STAND P,-;HUBBLE27,-,HIPS HB,BK26,L	1	S.A
...3	T0081	6001-001547	SCREW-MACHINE;BH,+,M4,L10(5),ZPC(BLK),SW	4	S.A
...3	M0081	6003-000275	SCREW-TAPTITE;BH,+,B,M3,L10,ZPC(BLK),S	5	S.N.A
...3	M0081	6003-001119	SCREW-TAPTITE;FH,+,S,M4,L10,ZPC(BLK),S	11	S.N.A
...3	HC+CW	6009-001370	SCREW-SPECIAL;PWH,+,M4,L8,ZPC(WHT),SWR	1	S.N.A
...3	CIS4	BN61-01438A	HOLDER-STAND;MATISSE HAS-STAND,SWRCH18A	1	S.N.A
...3		BN61-02570A	BRACKET-STAND BOTTOM;HUBBLE,SECC,3.0	1	S.N.A
...3		BN61-02572A	BRACKET-STAND BOTTOM;HUBBLE,ALDC	1	S.N.A
...3		BN61-02575A	BRACKET-STAND BODY;HUBBLE,SECC,T2.0	1	S.N.A
...3		BN61-02576A	BRACKET-STAND LIFT;HUBBLE,SECC,2.0	1	S.N.A
...3		BN61-02581A	HOLDER-SWIVEL RING;HUBBLE,ACETAL,2.5	1	S.N.A
...3		BN61-02634A	GUIDE-STAND RETAINER;HUBBLE,ACETALI,T2.0	2	S.N.A
...3		BN61-03118A	GUIDE-STAND LIFT;HUBBLE 27",ACETAL	1	S.N.A
...3	M0174	BN63-02666A	COVER-STAND TOP;HUBBLE,ABS HB,2.5,BK26	1	S.N.A
...3		BN63-02668A	COVER-STAND LIFT FRONT;HUBBLE,HIPS HB,2.	1	S.N.A
...3		BN63-02669A	COVER-STAND LIFT REAR;HUBBLE,HIPS HB,2.5	1	S.N.A
...3		BN63-02670A	COVER-STAND LIFT FRONT;HUBBLE,HIPS HB,2.	1	S.N.A
...3		BN63-02671A	COVER-STAND LIFT REAR;HUBBLE,HIPS HB,2.5	1	S.N.A
...3	M0412	BN63-02672A	COVER-SWIVEL BASE;HUBBLE,HIPS HB,2.5,BK2	1	S.N.A
...3		BN63-03079A	COVER-STAND VESA;HUBBLE27",ABS HB,2.8,BK	1	S.N.A
...3	T0004	BN63-03082A	COVER-STAND BASE;HUBBLE27",ABS HB,2.8,BK	1	S.N.A
...3	T0081	BN73-00085A	RUBBER CUSHION;MATISSE,##4.5(IN SIDE),CL	1	S.N.A
...3	M0007	BN96-01524C	ASSY STAND P-STOPPER,-;HUBBLE30",-;SUS,-	1	S.N.A
...3	M0126	BN96-05623A	ASSY STAND P-SPRING,-;HUBBLE 30",-;SUS,B	2	S.N.A
...3	T0054	BN96-04908C	ASSY HINGE P;HUBBLE,SK5,T2.0,275T	1	S.N.A
...3	T0132	BN73-00077A	RUBBER FOOT;MATISSE,BUMPON,##13.5,T2.0,6	4	S.N.A
0.1	M0017	BN91-01124A	ASSY CHASSIS-SPZ,WWW;LS30HUB*	1	S.N.A
.2	M0081	6003-000282	SCREW-TAPTITE;BH,+,B,M3,L8,ZPC(BLK),SW	3	S.A
.2	M0081	6003-000282	SCREW-TAPTITE;BH,+,B,M3,L8,ZPC(BLK),SW	4	S.A
.2	M0081	6003-001439	SCREW-TAPTITE;BH,+,S,M4,L8,ZPC(WHT),SW	1	S.N.A
.2	M0014	BN94-01009S	ASSY PCB MAIN-SPZ,WWW;LS30HUB*	1	S.A
...3	CN102	3701-001173	CONNECTOR-DVI;24P,3R,FEMALE,ANGLE,AUF	1	S.A
...3	CN330	3711-000057	HEADER-BOARD TO CABLE;BOX,3P,1R,2.5MM,AN	1	S.A
...3	CN330	3711-005955	HEADER-BOARD TO CABLE;BOX,16P,1R,2mm,ANG	1	S.A
...3	CN821	3722-001101	JACK-USB;4P/1C,AU,IVR,ANGLE,B TYPE	1	S.A
...3	CN801	3722-001414	JACK-USB;4P/2C,AUF,BLK,ANGLE,A TYPE	1	S.A

6 Electrical Parts List

Level	Loc. No.	Code No.	Description & Specification	Q'ty	SA/SNA
...3	CN802	3722-001414	JACK-USB;4P/2C,AUF,BLK,ANGLE,A TYPE	1	S.A
...3	T0174	BN97-01026Z	ASSY SMD;LS30HUB*	1	S.N.A
...4	SUB05	0202-001477	SOLDER-CREAM;LST309-M,-,D20-45##,96.5Sn/	1,048	S.N.A
...4	D100	0401-001056	DIODE-SWITCHING;MMBD4148SE,100V,200mA,SO	1	S.A
...4	D101	0401-001056	DIODE-SWITCHING;MMBD4148SE,100V,200mA,SO	1	S.A
...4	D102	0401-001056	DIODE-SWITCHING;MMBD4148SE,100V,200mA,SO	1	S.A
...4	D103	0401-001056	DIODE-SWITCHING;MMBD4148SE,100V,200mA,SO	1	S.A
...4	D104	0401-001056	DIODE-SWITCHING;MMBD4148SE,100V,200mA,SO	1	S.A
...4	D105	0401-001056	DIODE-SWITCHING;MMBD4148SE,100V,200mA,SO	1	S.A
...4	D106	0401-001056	DIODE-SWITCHING;MMBD4148SE,100V,200mA,SO	1	S.A
...4	D107	0401-001056	DIODE-SWITCHING;MMBD4148SE,100V,200mA,SO	1	S.A
...4	D116	0401-001056	DIODE-SWITCHING;MMBD4148SE,100V,200mA,SO	1	S.A
...4	D117	0401-001056	DIODE-SWITCHING;MMBD4148SE,100V,200mA,SO	1	S.A
...4	D118	0401-001056	DIODE-SWITCHING;MMBD4148SE,100V,200mA,SO	1	S.A
...4	D119	0401-001056	DIODE-SWITCHING;MMBD4148SE,100V,200mA,SO	1	S.A
...4	D120	0401-001056	DIODE-SWITCHING;MMBD4148SE,100V,200mA,SO	1	S.A
...4	D121	0401-001056	DIODE-SWITCHING;MMBD4148SE,100V,200mA,SO	1	S.A
...4	D821	0401-001056	DIODE-SWITCHING;MMBD4148SE,100V,200mA,SO	1	S.A
...4	D822	0401-001056	DIODE-SWITCHING;MMBD4148SE,100V,200mA,SO	1	S.A
...4	D0254	0402-000553	DIODE-SCHOTTKY;SS24/B240,40V,2000mA,DO-2	1	S.A
...4	D0254	0402-000553	DIODE-SCHOTTKY;SS24/B240,40V,2000mA,DO-2	1	S.A
...4	D0254	0402-000553	DIODE-SCHOTTKY;SS24/B240,40V,2000mA,DO-2	1	S.A
...4	D0254	0402-000553	DIODE-SCHOTTKY;SS24/B240,40V,2000mA,DO-2	1	S.A
...4	D115	0403-000258	DIODE-ZENER;BZX84C5V6,5.2-6V,225mW,SOT-2	1	S.A
...4	ZD104	0403-000258	DIODE-ZENER;BZX84C5V6,5.2-6V,225mW,SOT-2	1	S.A
...4	ZD106	0403-000258	DIODE-ZENER;BZX84C5V6,5.2-6V,225mW,SOT-2	1	S.A
...4	ZD108	0403-000258	DIODE-ZENER;BZX84C5V6,5.2-6V,225mW,SOT-2	1	S.A
...4	ZD801	0403-000258	DIODE-ZENER;BZX84C5V6,5.2-6V,225mW,SOT-2	1	S.A
...4	ZD802	0403-000258	DIODE-ZENER;BZX84C5V6,5.2-6V,225mW,SOT-2	1	S.A
...4	ZD803	0403-000258	DIODE-ZENER;BZX84C5V6,5.2-6V,225mW,SOT-2	1	S.A
...4	ZD804	0403-000258	DIODE-ZENER;BZX84C5V6,5.2-6V,225mW,SOT-2	1	S.A
...4	D802	0403-001411	DIODE-ZENER;-5.49-5.73V,200mW,SOD-323,T	1	S.A
...4	D804	0403-001411	DIODE-ZENER;-5.49-5.73V,200mW,SOD-323,T	1	S.A
...4	ZD107	0403-001435	DIODE-ZENER;QZX363C5V6,5.32-5.88V,200MW,	1	S.A
...4	ZD200	0406-001061	DIODE-TVS;MMQA5V6T3,5.32/5.6/5.88V,24W,S	1	S.A
...4	Q101	0501-002080	TR-SMALL SIGNAL;2SC2412K,NPN,200mW,SC-59	1	S.A
...4	Q401	0501-002080	TR-SMALL SIGNAL;2SC2412K,NPN,200mW,SC-59	1	S.A
...4	Q404	0501-002080	TR-SMALL SIGNAL;2SC2412K,NPN,200mW,SC-59	1	S.A
...4	Q812	0501-002080	TR-SMALL SIGNAL;2SC2412K,NPN,200mW,SC-59	1	S.A
...4	Q409	0505-000110	FET-SILICON;2N7002,N,60V,115mA,7.5ohm,0.	1	S.A
...4	Q409	0505-001957	FET-SILICON;NTR2101P,P,-8V,-3.7A,0.052oh	1	S.A
...4	T0596	0904-001972	IC-USC;USB2504,8Bit,TQFP,64P,10x10x1.4mm	1	S.A
...4	IC112	1103-000129	IC-EEPROM;24C02,2Kbit,256x8Bit,SOP,8P,5x	1	S.A
...4	IC112	1103-001314	IC-EEPROM;24C16,2Kx8,SOP,8P,5x4mm,2.7/5.	1	S.A
...4	IC112	1103-001314	IC-EEPROM;24C16,2Kx8,SOP,8P,5x4mm,2.7/5.	1	S.A
...4	T0087	1203-002842	IC-POSI.FIXED REG.;AP1117D-33A,TO-252,3P	1	S.A
...4	T0087	1203-002842	IC-POSI.FIXED REG.;AP1117D-33A,TO-252,3P	1	S.A
...4	P803T	1404-001223	THERMISTOR-PTC;45mohm,20.6V,-,40A,4A,TP	1	S.A
...4	R110	2007-000060	R-CHIP;100Kohm,1%,1/10W,TP,1608	1	S.A
...4	R110	2007-000060	R-CHIP;100Kohm,1%,1/10W,TP,1608	1	S.A
...4	R110	2007-000060	R-CHIP;100Kohm,1%,1/10W,TP,1608	1	S.A
...4	R110	2007-000060	R-CHIP;100Kohm,1%,1/10W,TP,1608	1	S.A
...4	R110	2007-000060	R-CHIP;100Kohm,1%,1/10W,TP,1608	1	S.A
...4	R110	2007-000070	R-CHIP;0ohm,5%,1/10W,TP,1608	1	S.A
...4	R110	2007-000070	R-CHIP;0ohm,5%,1/10W,TP,1608	1	S.A
...4	R110	2007-000070	R-CHIP;0ohm,5%,1/10W,TP,1608	1	S.A
...4	R110	2007-000070	R-CHIP;0ohm,5%,1/10W,TP,1608	1	S.A

Level	Loc. No.	Code No.	Description & Specification	Q'ty	SA/SNA
....4	C600	2402-001081	C-AL,SMD;100uF,20%,25V,WT,TP,8.3x8.3x10	1	SA
....4	C611	2402-001081	C-AL,SMD;100uF,20%,25V,WT,TP,8.3x8.3x10	1	SA
....4	C614	2402-001081	C-AL,SMD;100uF,20%,25V,WT,TP,8.3x8.3x10	1	SA
....4	C605	2402-001128	C-AL,SMD;100#F,20%,16V,-,TP,6.3X5.7mm	1	SA
....4	C120	2402-001254	C-AL,SMD;10uF,20%,50V,WT,TP,6.3x5.2mm	1	SA
....4	C608	2402-001254	C-AL,SMD;10uF,20%,50V,WT,TP,6.3x5.2mm	1	SA
....4	C842	2409-001065	C-ORGANIC;82uF,20%,16V,WT,TP,8X6.9mm,-	1	SA
....4	C844	2409-001065	C-ORGANIC;82uF,20%,16V,WT,TP,8X6.9mm,-	1	SA
....4	X202	2801-003326	CRYSTAL-SMD;24MHZ,30PPM,28-ABX,20PF,50OH	1	SA
....4	X202	2801-003326	CRYSTAL-SMD;24MHZ,30PPM,28-ABX,20PF,50OH	1	SA
....4	T0568	3301-001145	BEAD-SMD;60ohm,4516,TP,70ohm/45MHz,82ohm	1	S.N.A
....4	T0568	3301-001145	BEAD-SMD;60ohm,4516,TP,70ohm/45MHz,82ohm	1	S.N.A
....4	T0568	3301-001145	BEAD-SMD;60ohm,4516,TP,70ohm/45MHz,82ohm	1	S.N.A
....4	T0568	3301-001145	BEAD-SMD;60ohm,4516,TP,70ohm/45MHz,82ohm	1	S.N.A
....4	T0568	3301-001145	BEAD-SMD;60ohm,4516,TP,70ohm/45MHz,82ohm	1	S.N.A
....4	T0568	3301-001145	BEAD-SMD;60ohm,4516,TP,70ohm/45MHz,82ohm	1	S.N.A
....4	T0568	3301-001145	BEAD-SMD;60ohm,4516,TP,70ohm/45MHz,82ohm	1	S.N.A
....4	T0568	3301-001145	BEAD-SMD;60ohm,4516,TP,70ohm/45MHz,82ohm	1	S.N.A
....4	T0568	3301-001145	BEAD-SMD;60ohm,4516,TP,70ohm/45MHz,82ohm	1	S.N.A
....4	T0568	3301-001412	BEAD-SMD;60ohm,2012,800mA,TP,65ohm/110MH	1	S.N.A
....4	T0568	3301-001412	BEAD-SMD;60ohm,2012,800mA,TP,65ohm/110MH	1	S.N.A
....4	T0568	3301-001412	BEAD-SMD;60ohm,2012,800mA,TP,65ohm/110MH	1	S.N.A
....4	T0568	3301-001412	BEAD-SMD;60ohm,2012,800mA,TP,65ohm/110MH	1	S.N.A
....4	T0568	3301-001412	BEAD-SMD;60ohm,2012,800mA,TP,65ohm/110MH	1	S.N.A
....4	T0568	3301-001412	BEAD-SMD;60ohm,2012,800mA,TP,65ohm/110MH	1	S.N.A
....4	T0568	3301-001412	BEAD-SMD;60ohm,2012,800mA,TP,65ohm/110MH	1	S.N.A
....4	T0568	3301-001412	BEAD-SMD;60ohm,2012,800mA,TP,65ohm/110MH	1	S.N.A
....4	T0568	3301-001412	BEAD-SMD;60ohm,2012,800mA,TP,65ohm/110MH	1	S.N.A
....4	T0568	3301-001412	BEAD-SMD;60ohm,2012,800mA,TP,65ohm/110MH	1	S.N.A
....4	T0568	3301-001594	BEAD-SMD;90ohm,2.0*1.2*1.3mm,-,TP,-,-,-	1	S.N.A
....4	T0568	3301-001594	BEAD-SMD;90ohm,2.0*1.2*1.3mm,-,TP,-,-,-	1	S.N.A
....4	T0568	3301-001594	BEAD-SMD;90ohm,2.0*1.2*1.3mm,-,TP,-,-,-	1	S.N.A
....4	T0568	3301-001594	BEAD-SMD;90ohm,2.0*1.2*1.3mm,-,TP,-,-,-	1	S.N.A
....4	T0077	BN41-00768A	PCB MAIN;Hubble,FR-4,2L,1.0,1.6,150*100,	1	S.N.A
....4	MICOM	BN97-01071L	ASSY MICOM-SPZ,W/W;LS30HUB*,W/W	1	SA
....5	IC520	0903-001397	IC-MICROCONTROLLER;WT61P4,8Bit,PLCC,44P,	1	S.N.A
....4	IC202	1203-001559	IC-RESET;DS1834A,SOIC,8P,150MIL,PLASTIC,	1	SA
....4	D801	0406-001217	DIODE-TVS;NUP4301MR6,6/-V,500W,TSOP-6	1	SA
....4	D803	0406-001217	DIODE-TVS;NUP4301MR6,6/-V,500W,TSOP-6	1	SA
....4	CN330	3711-005470	HEADER-BOARD TO CABLE;BOX,30P,1R,1.25mm,	1	SA
....4	CN330	3711-005497	HEADER-BOARD TO CABLE;BOX,15P,1R,1.25MM,	1	SA
....4	CN330	3711-005543	HEADER-BOARD TO CABLE;BOX,6P,1R,1.25mm,S	1	SA
....4	R110	2007-000512	R-CHIP;2.4Kohm,5%,1/10W,TP,1608	1	SA
....4	Q409	0505-002169	FET-SILICON;Si4435BDY-T1-E3,P,-30V,-9.1A	1	S.N.A
....4	Q409	0505-002169	FET-SILICON;Si4435BDY-T1-E3,P,-30V,-9.1A	1	S.N.A
...3	CN402	3711-004121	HEADER-BOARD TO BOARD;BOX,14P,1R,2mm,ANG	1	SA
...3	T0245	0202-001608	SOLDER-WIRE FLUX;LFC7-107,D0.8,99.3Sn/0.	0.003	S.N.A
..2	M0006	BN96-03656A	ASSY SHIELD P-COVER;HUBBLE,SECC,T0.8	1	S.N.A
...3	M0107	BN63-02673A	SHIELD-COVER;HUBBLE,SECC,0.8	1	S.N.A
...3	M0114	AA61-20129A	HOLDER-WIRE;-NYLON-66,-,-,NTR,DAFC-25	1	S.N.A
...3	M0131	BN63-00647A	GASKET;GH19BS,CONDUCTIVE FAB,0.3MM,20MM,	1	S.N.A
...3	M0131	BN63-02969A	GASKET;GASKET EMI,Polyurethane Sponge+Po	1	S.N.A
...3	M0131	BN63-02970A	GASKET;GASKET EMI,Polyurethane Sponge+Po	1	S.N.A
...3	M0131	BN63-02971A	GASKET;GASKET EMI,Polyurethane Sponge+Po	1	S.N.A
...3	M0131	BN63-02972A	GASKET;GASKET EMI,Polyurethane Sponge+Po	2	S.N.A
...3	M0131	BN63-02973A	GASKET;GASKET EMI,Polyurethane Sponge+Po	1	S.N.A
...3	M0131	BN63-02975A	GASKET;GASKET EMI,Polyurethane Sponge+Po	1	S.N.A
...3	M0114	AA61-20069A	HOLDER-WIRE;-NYLON-66,-,-,NTR,V0,PAWH	1	S.N.A

6 Electrical Parts List

Level	Loc. No.	Code No.	Description & Specification	Q'ty	SA/SNA
..2	M2893	BN39-00482B	LEAD CONNECTOR;HUBBLE,UL2835#28,UL/CSA,1	1	S.A
..2	T0297	BN39-00753A	CABLE FORM CONN.COAX-TMDS HARN;HUBBLE,UL	1	S.A
..2	T0159	BN96-03938A	ASSY PCB P-SMPS;FreeVoltage SMPS,Hubble3	1	S.A
..2	MP1.0	BN96-04386A	ASSY BRACKET P-GUIDE POWER;- ,HUBBLE30",-	1	S.N.A
...3	T0514	BN61-02582A	BRACKET-SUPPORT;HUBBLE,SPTe,0.3	1	S.N.A
...3	M0131	BN63-02967A	GASKET;GASKET EMI,Polyurethane Sponge+Po	1	S.N.A
...3	M0131	BN63-02969A	GASKET;GASKET EMI,Polyurethane Sponge+Po	1	S.N.A
..2	M0251	BN96-04422A	ASSY CABLE P;HUBBLE,SEC VD DIVISION,WORL	1	S.A
..2	T0081	6006-000245	SCREW-MACHINE;PH,+ ,WSP,M4,L8,ZPC(WHT),SW	1	S.N.A
..2		BN96-04553A	ASSY SHIELD P-EMI;HUBBLE30",SECC,T0.8	1	S.N.A
...3	T0528	BN63-03046A	GASKET-SHIELD;HUBBLE30",SECC,T0.8	1	S.N.A
...3	M0131	BN63-03064A	GASKET;HUBBLE,Polyurethane Sponge+Polyes	1	S.N.A
..2	T0562	6046-001013	STAND OFF;M3,L5,Ni PLT,SUM24L,#4-40	2	S.N.A
..2	CCMM1	BN73-00174A	SILICON/RUBBER;HUBBLE,GP1500,60x30x5,k=1	1	S.N.A
0.1	M0112	BN91-01139A	ASSY SHIELD;LS30HUBCB/XAA	1	S.N.A
..2	M0081	6003-000282	SCREW-TAPTITE;BH,+ ,-,B,M3,L8,ZPC(BLK),SW	2	S.A
..2	M0081	6003-001439	SCREW-TAPTITE;BH,+ ,-,S,M4,L8,ZPC(WHT),SW	4	S.N.A
..2		BN96-04387A	ASSY BRACKET P-CASE TOP;- ,HUBBLE30",-,SP	1	S.N.A
...3		BN63-02674A	SHIELD-CONNECTOR;HUBBLE,SPTe,0.3	1	S.N.A
...3	M0131	BN63-02966A	GASKET;GASKET EMI,Polyurethane Sponge+Po	1	S.N.A
...3	M0131	BN63-02968A	GASKET;GASKET EMI,Polyurethane Sponge+Po	1	S.N.A
...3	M0131	BN63-03264A	GASKET;LS27HUB(HUBBLE 27"),Fabric Gasket	1	S.N.A
..2	M2893	BN39-00757A	LEAD CONNECTOR;HUBBLE,UL1007#26,UL/CSA,1	1	S.A
..2	CIS1	0203-002475	TAPE-AL;DK-100-360-93-1S,AL-Foil, Flame	1	S.N.A
0.1	T0852	BN91-01858A	ASSY LCD-SPZ;LS30HUX*	1	S.N.A
..2	M0215	BN07-00470A	LCD-PANEL;LTM300M1-P02,Hubble,8BIT,677.3	1	S.A
0.1	M0113	BN92-01751Z	ASSY P/MATERIAL;LS30HUUBCB/XAA	1	S.N.A
..2	T0376	6902-000061	BAG AIR;LDPE,T0.2,L1000,W500,TRP,,,	0.003	S.N.A
..2	T0376	6902-000379	BAG AIR;LDPE,T0.2,W1000,L1800,TRP,-,-	0.007	S.N.A
..2	T0003	6902-000604	BAG WRAPPING;LDPE,T0.02,W500,L10000,TRP,	5.75	S.N.A
..2	M0081	6902-000609	BAG ROLL;LDPE,T0.05,W2400,L1000,TRP,-,-	0.135	S.N.A
..2	T0524	6902-000410	BAG PE;HDPE/NITRON,T0.015/T0.5,W850,L800	1	S.N.A
0.1	M0019	BN92-02330V	ASSY LABEL;LS30HUBCB/XSF	1	S.N.A
0.1	M0003	BN92-02989E	ASSY BOX;LS30HUXCB/XSF,305TPLUS	1	S.N.A
..2	M0045	BN69-02102B	BOX-MONITOR;LS30HUB(S/M305T Plus),CB,A1,	1.01	S.N.A
0.1	M0045	BN92-02999B	ASSY ACCESSORY;LS30HUXCB/XSF	1	S.N.A
..2	T0725	BN39-00397C	CBF INTERFACE-USB;SPL-07,4P/4P,2725(USB2	1	S.A
..2	T0299	BN39-00754A	CBF SIGNAL-DVI-D DUAL LINK;HUBBLE,24P/24	1	S.A
..2	M0045	BN96-06367C	ASSY ACCESSORY;LS30HUXCB/XSF	1	S.A
...3	T0268	3903-000082	CBF-POWER CORD;DT,CN,IP3/YES(A),(IEC C1	1	S.A
...3	T0524	6902-000110	BAG PE;LDPE,T0.05,W250,L400,TRP,28,2	1	S.N.A
...3	M0113	BH68-70455A	CARD-TESTED GOODS;ALL (CHINA),SAMAUNG,CH	1	S.N.A
...3	ACCESSORY	BH75-00146B	UNIT-11,WARRANTY;CHINA,- ,ASS'Y-W/CARD,BH	1	S.N.A
....4	CIS	BH68-00297E	MANUAL FLYER-11,WARRANTY CARD;SAMSUNG BA	1	S.N.A
....4	CIS	BH68-00297F	MANUAL FLYER-10,WARRANTY CARD;ENVELOPE,S	1	S.N.A
...3	ACCESSORY	BN68-01118A	MANUAL-02,TCO99 CARD;COMM,W/W,Mojo 100g,	1	S.N.A
...3	M0215	BN96-03966N	ASSY MANUAL P-IB+QSG;305T,305TPLUS,- ,Syn	1	S.N.A
....4	CD	BN59-00565N	S/W DRIVER-1,IB;305T,305TPLUS,W/W,SynclMa	1	S.N.A
....4	QSG	BN68-01073A	MANUAL FLYER-QSG;305T,SynclMaster,Multe,M	1	S.N.A

5 Exploded View and Parts List

-You can search for updated part codes through ITSELF web site.

URL : <http://itself.sec.samsung.co.kr>

5-1. Exploded View

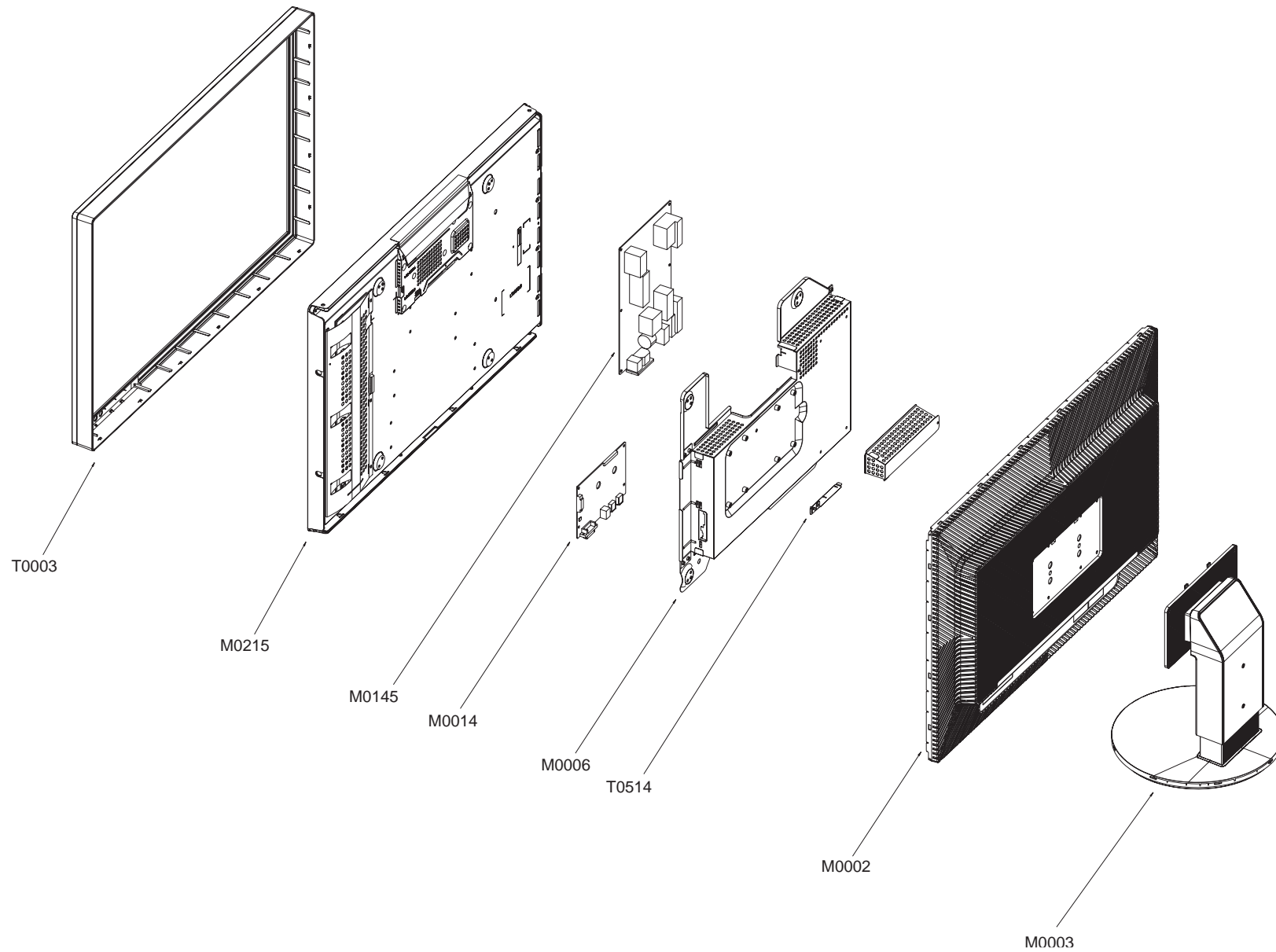

5-1-1. LS30HUXCB/XSF Parts List

Location	Code.No	Item & Specification	Q'ty	SA/SNA	Remark
T0003	BN96-03652F	ASSY COVER P-FRONT;LS30HUX(305T PLUS),,H	1	S.A	
M0215	BN07-00470A	LCD-PANEL;LTM300M1-P02,Hubble,8BIT,677.3	1	S.A	
M0145	BN96-04050A	ASSY BOARD P-FUNCTION;HUBBLE,SJ06-01-013	1	S.A	
M0014	BN94-01009S	ASSY PCB MAIN-SPZ,W/W;LS30HUB*	1	S.A	
M0006	BN96-03656A	ASSY SHIELD P-COVER;HUBBLE,SECC,T0.8	1	S.N.A	
T0514	BN61-02582A	BRACKET-SUPPORT;HUBBLE,SPT0.3	1	S.N.A	
M0002	BN90-01015A	ASSY COVER REAR;LS30HUBCB/XAA	1	S.N.A	
M0003	BN96-04718B	ASSY STAND P,-;HUBBLE27,-;HIPS HB,BK26,L	1	S.A	

10 Operating Instructions and Installation

10-1 Product Features



0°(Standard)



Swivle



Tilt

- Improved Response Time by Adopting RTA : 6 ms (Based on "Gray to Gray")
- High contrast ratio & high aperture structure
- High speed response
- WQXGA (2560 x 1600 pixels) resolution
- S-PVA (Super Patterned Vertical Alignment) mode
- Direct BLU Structure (Cold Cathod Fluorescent Tube)
- Sync & DE(Data Enable) mode
- Dual Link TMDS serial interface (4pixel/clock)
- RoHS compliance
- Pb-free compliance
- VESA Mount 200 x 100 mm, 100 x 100 mm

10-2 Component & Function



1. Brightness button

Push the button to adjust brightness.

↗ : The screen is getting bright.

↘ : The screen is getting dark.

2. Power button / Power indicator

Turns the monitor on/off. /

This light glows blue during normal operation, and blinks blue once as the monitor saves your adjustments.

10-3 Installation Instructions



(The configuration at the back of the monitor may vary from product to product.)

A

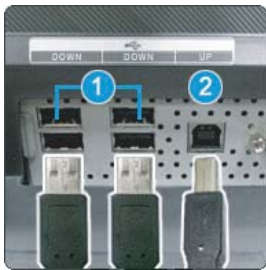

1. USB DOWNSTREAM :

Connect the USB DOWN port of the USB monitor and a USB device with the USB cable.

2. USB UPSTREAM :

Connect the USB UP port of the monitor and the USB port of the computer with the USB cable.

B



DVI IN

Connect the DVI-D (Dual link) Cable to the DVI IN port on the back of your monitor.

C



1. ON [|] / OFF [O]

Switch the monitor on and off.

2. POWER

Connect the power cord for your monitor to the POWER port on the back of the monitor.

D

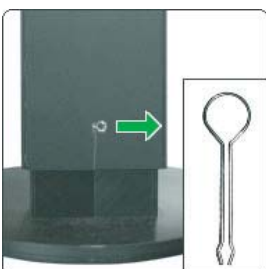

Stand Stopper

Remove the fixing pin on the stand to lift the monitor up and down.

12 PCB Diagram

12-1 PCB Diagram (Main)

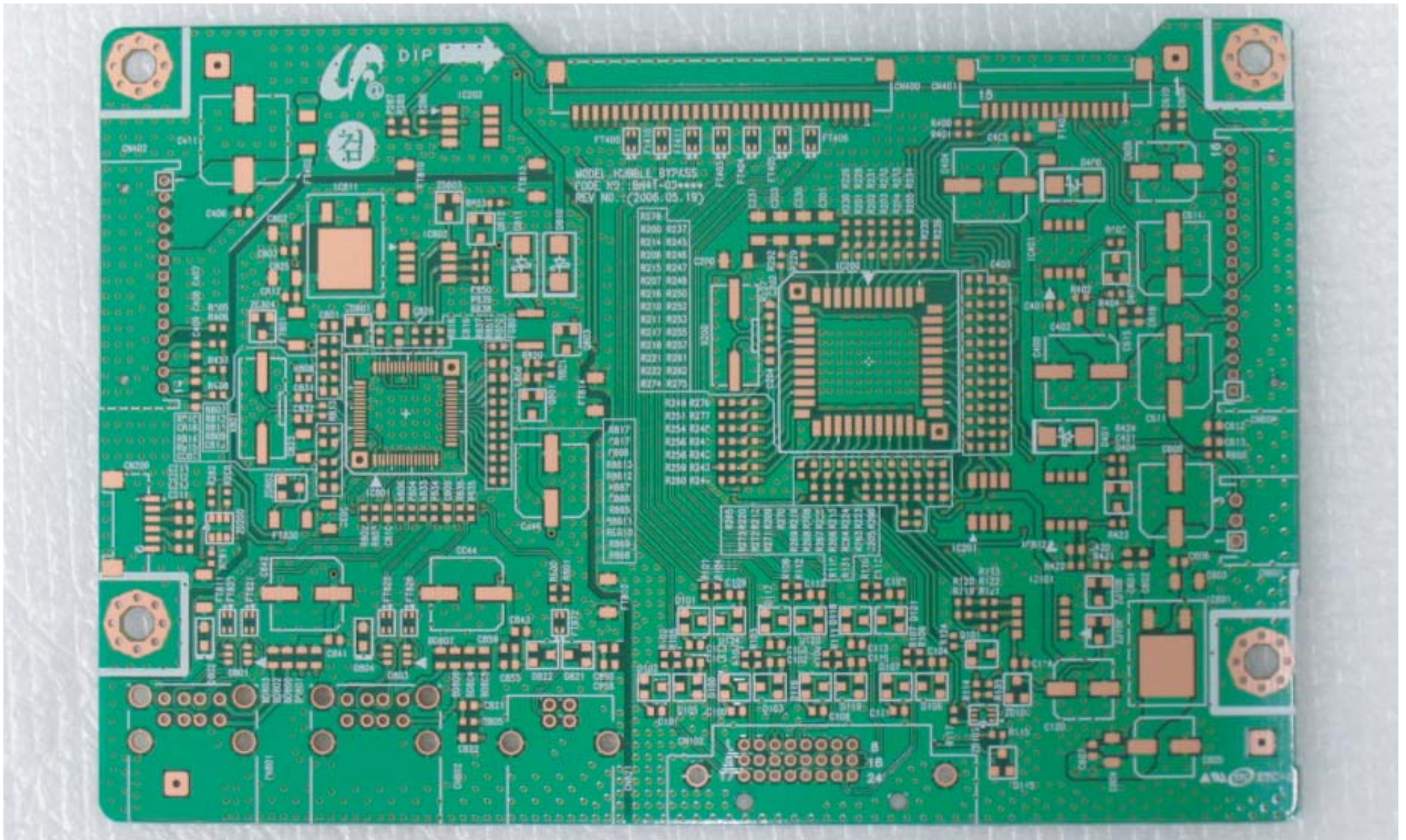

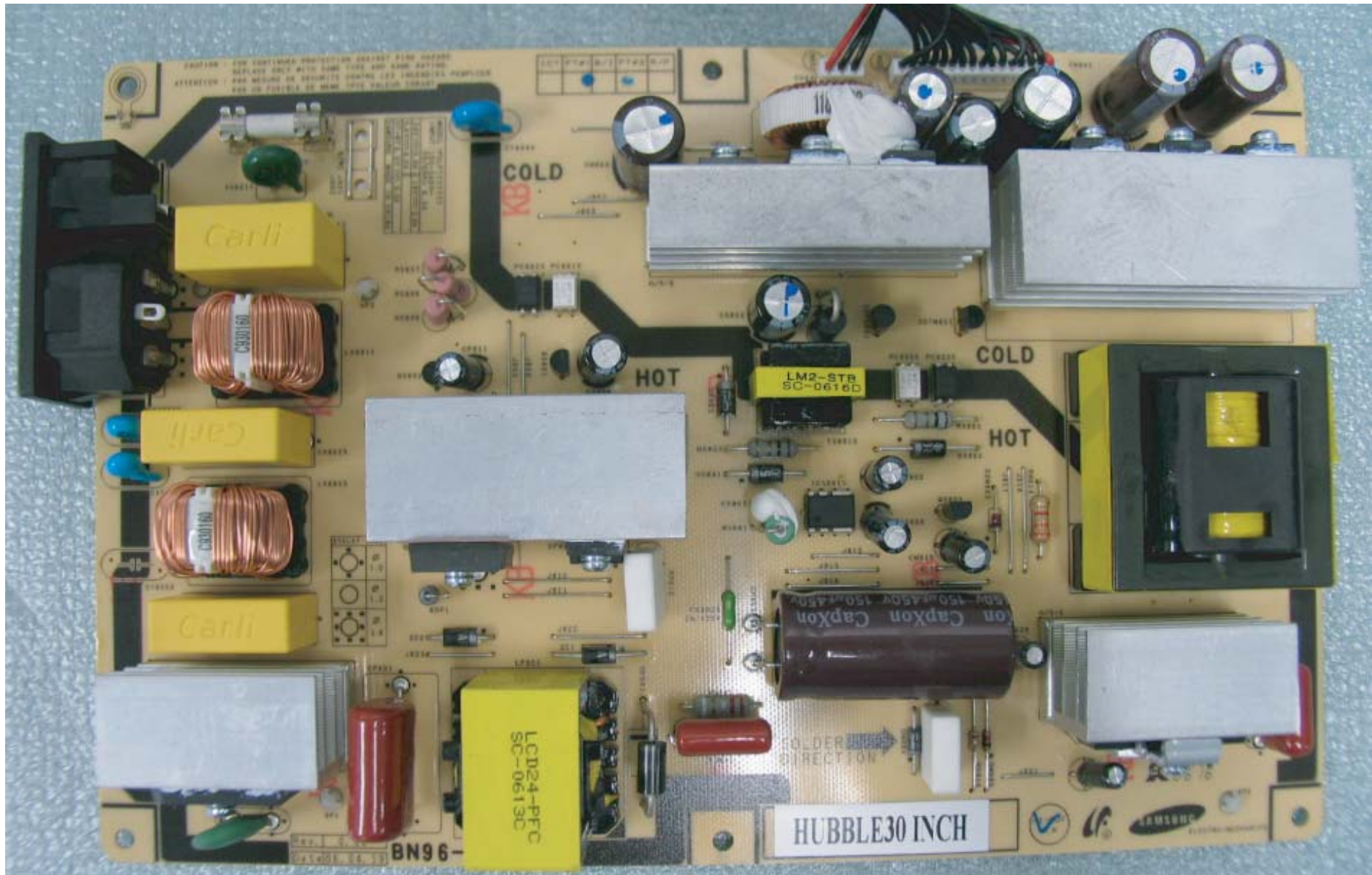

1 Precautions

Follow these safety, servicing and ESD precautions to prevent damage and to protect against potential hazards such as electrical shock.

1-1 Safety Precautions

1-1-1 Warnings

1. For continued safety, do not attempt to modify the circuit board.
2. Disconnect the AC power and DC power jack before servicing.

1-1-2 Servicing the LCD Monitor

1. When servicing the LCD Monitor, Disconnect the AC line cord from the AC outlet.
2. It is essential that service technicians have an accurate voltage meter available at all times. Check the calibration of this meter periodically.

1-1-3 Fire and Shock Hazard

Before returning the monitor to the user, perform the following safety checks:

1. Inspect each lead dress to make certain that the leads are not pinched or that hardware is not lodged between the chassis and other metal parts in the monitor.
2. Inspect all protective devices such as nonmetallic control knobs, insulating materials, cabinet backs, adjustment and compartment covers or shields, isolation resistor-capacitor networks, mechanical insulators, etc.
3. Leakage Current Hot Check (Figure 1-1):

WARNING : Do not use an isolation transformer during this test.

Use a leakage current tester or a metering system that complies with American National Standards Institute (*ANSI C101.1, Leakage Current for Appliances*), and Underwriters Laboratories (*UL Publication UL1410, 59.7*).

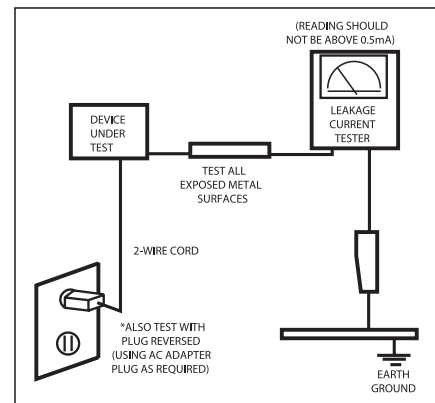

Figure 1-1. Leakage Current Test Circuit

4. With the unit completely reassembled, plug the AC line cord directly into a 120V AC outlet. With the unit's AC switch first in the ON position and then OFF, measure the current between a known earth ground (metal water pipe, conduit, etc.) and all exposed metal parts, including: metal cabinets, screwheads and control shafts. The current measured should not exceed 0.5 milliamp. Reverse the power-plug prongs in the AC outlet and repeat the test.

1-1-4 Product Safety Notices

Some electrical and mechanical parts have special safety-related characteristics which are often not evident from visual inspection. The protection they give may not be obtained by replacing them with components rated for higher voltage, wattage, etc. Parts that have special safety characteristics are identified by \triangle on schematics and parts lists. A substitute replacement that does not have the same safety characteristics as the recommended replacement part might create shock, fire and/or other hazards. Product safety is under review continuously and new instructions are issued whenever appropriate.

1-2 Servicing Precautions

WARNING: An electrolytic capacitor installed with the wrong polarity might explode.

Caution: Before servicing units covered by this service manual, read and follow the Safety Precautions section of this manual.

Note: If unforeseen circumstances create conflict between the following servicing precautions and any of the safety precautions, always follow the safety precautions.

1-2-1 General Servicing Precautions

1. Always unplug the unit's AC power cord from the AC power source and disconnect the DC Power Jack before attempting to:
(a) remove or reinstall any component or assembly, (b) disconnect PCB plugs or connectors, (c) connect a test component in parallel with an electrolytic capacitor.
2. Some components are raised above the printed circuit board for safety. An insulation tube or tape is sometimes used. The internal wiring is sometimes clamped to prevent contact with thermally hot components. Reinstall all such elements to their original position.
3. After servicing, always check that the screws, components and wiring have been correctly reinstalled. Make sure that the area around the serviced part has not been damaged.
4. Check the insulation between the blades of the AC plug and accessible conductive parts (examples: metal panels, input terminals and earphone jacks).
5. Insulation Checking Procedure: Disconnect the power cord from the AC source and turn the power switch ON. Connect an insulation resistance meter (500 V) to the blades of the AC plug.
The insulation resistance between each blade of the AC plug and accessible conductive parts (see above) should be greater than 1 megohm.
6. Always connect a test instrument's ground lead to the instrument chassis ground before connecting the positive lead; always remove the instrument's ground lead last.

1-3 Static Electricity Precautions

Some semiconductor (solid state) devices can be easily damaged by static electricity. Such components are commonly called Electrostatically Sensitive Devices (ESD). Examples of typical ESD are integrated circuits and some field-effect transistors. The following techniques will reduce the incidence of component damage caused by static electricity.

1. Immediately before handling any semiconductor components or assemblies, drain the electrostatic charge from your body by touching a known earth ground. Alternatively, wear a discharging wrist-strap device. To avoid a shock hazard, be sure to remove the wrist strap before applying power to the monitor.
2. After removing an ESD-equipped assembly, place it on a conductive surface such as aluminum foil to prevent accumulation of an electrostatic charge.
3. Do not use freon-propelled chemicals. These can generate electrical charges sufficient to damage ESDs.
4. Use only a grounded-tip soldering iron to solder or desolder ESDs.
5. Use only an anti-static solder removal device. Some solder removal devices not classified as "anti-static" can generate electrical charges sufficient to damage ESDs.
6. Do not remove a replacement ESD from its protective package until you are ready to install it. Most replacement ESDs are packaged with leads that are electrically shorted together by conductive foam, aluminum foil or other conductive materials.
7. Immediately before removing the protective material from the leads of a replacement ESD, touch the protective material to the chassis or circuit assembly into which the device will be installed.
Caution: Be sure no power is applied to the chassis or circuit and observe all other safety precautions.
8. Minimize body motions when handling unpackaged replacement ESDs. Motions such as brushing clothes together, or lifting your foot from a carpeted floor can generate enough static electricity to damage an ESD.

1 Precautions

1-4 Installation Precautions

1. For safety reasons, more than two people are required for carrying the product.
2. Keep the power cord away from any heat emitting devices, as a melted covering may cause fire or electric shock.
3. Do not place the product in areas with poor ventilation such as a bookshelf or closet. The increased internal temperature may cause fire.
4. Bend the external antenna cable when connecting it to the product. This is a measure to protect it from being exposed to moisture. Otherwise, it may cause a fire or electric shock.
5. Make sure to turn the power off and unplug the power cord from the outlet before repositioning the product. Also check the antenna cable or the external connectors if they are fully unplugged. Damage to the cord may cause fire or electric shock.
6. Keep the antenna far away from any high-voltage cables and install it firmly. Contact with the high-voltage cable or the antenna falling over may cause fire or electric shock.
7. When installing the product, leave enough space (10cm) between the product and the wall for ventilation purposes. A rise in temperature within the product may cause fire.

1 Precautions

Memo

2 Product Specifications

2-1 Fashion Feature

- Improved Response Time by Adopting RTA: 6ms (Based on "Gray to Gray")
- High contrast ratio & high aperture structure
- High speed response
- WQXGA (2560 x 1600 pixels) resolution
- S-PVA (Super Patterned Vertical Alignment) mode
- Direct BLU Structure (Cold Cathod Fluorescent Tube)
- Sync & DE(Data Enable) mode
- Dual Link TMDS serial interface (4pixel/clock)
- RoHS compliance
- Pb-free compliance





2-2 Spec Comparison

Key Specification	
Model	LHU30BS 305T PLUS
Screen Size	30"
Brightness	300cd/m ²
Contrast	1000 : 1
Fast Response Time	RTA chip 6ms (g to g) 16ms (w to b)
Magic color	X
Magic Pivot	X
Magic Tune	X
Magic Zone	X
Detail control Gamma, Color temperature	X
Sharpness	X
Magic Bright	X



2-3 Specifications

Item	Description
LCD Panel	TFT-LCD panel, RGB vertical stripe, normally black transmissive, 30-Inch viewable, 0.2505 (H) x 0.2505 (V) mm pixel pitch
Scanning Frequency	Horizontal : 98.7kHz Vertical : 60Hz
Display Colors	16.7 Million colors
Maximum Resolution	Horizontal : 2560 Pixels Vertical : 1600 Pixels
Input Video Signal	DVI-D, 0.7 V _{p-p} ± 1% positive at 100Ω, internally terminated
Input Sync Signal	Type : Seperate H/V sync
Maximum Pixel Clock rate	268.5 MHz
Active Display Horizontal/Vertical	641.28 mm / 400.8 mm
AC power voltage & Frequency	AC 90 ~ 264 Volts, 60/50 Hz
Power Consumption	130W (Max)
Dimensions Set (W x D x H)	690.2 x 502 x 280 mm (27.2 x 19.8 x 11 inch)
Weight (Set)	12 kg
Environmental Considerations	Operating Temperature : 50°F ~ 104°F (10°C ~ 40°C) Operating Humidity : 10 % ~ 80 % Storage Temperature : -13°F ~ 113°F (-25°C ~ 45°C) Storage Humidity : 5 % ~ 95 %
-Designs and specifications are subject to change without prior notice.	

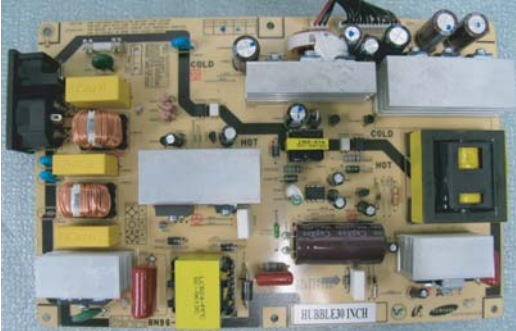
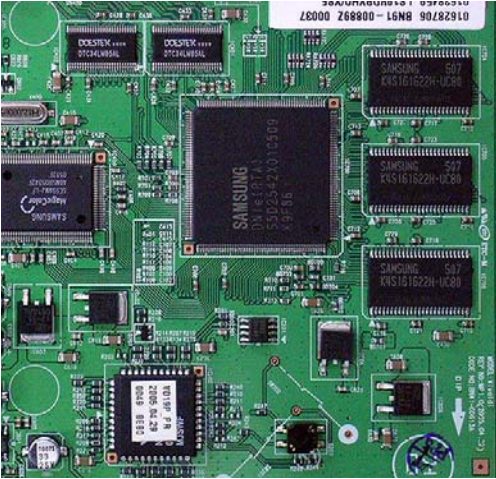
2-4 Spec Comparison to the Old Models

Model	LHU30BS(305T PLUS)	LS17VDP(770P) LS19VDP(970P)
Design		
Reponses Time	6ms (Gray to Gray) The IC for the enhancement of the response time is applied.	8ms (Gray to Gray) The IC for the enhancement of the response time is applied.
Magic pivot	X	AUTO(Pivot program + Sensor IC)
Magic color	X	0
Magic zone	X	0
Magic tune	X	Ver 3.6 Applied
Main PBA		
SMPS PBA		

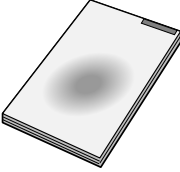
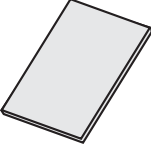
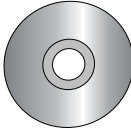
2-5 Option Specification

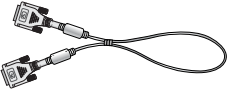
Item	Item Name	CODE.NO	Remark
	Quick Setup Guide	BN68-00847B	
	Warranty Card (Not available in all locations)	BH75-00146B	
	User's manual, Monitor Driver	BN59-00565A	
	Power Cord	3903-000082	
	DVI Cable	BN39-00754A	

14 Reference Information

14-1 Technical Terms

-TFT-LCD

(Thin film Transistor Liquid Crystal Display)

ADC(Analog to Digital Converter)

This is a circuit that converts from analog signal to digital signals.

-PLL(Phase Locked Loop)

During progressing ADC, Device makes clock synchronizing HSYNC with Video clock

-Inverter

Device that supply Power to LCD panel lamp. this device generate about 1,500~2,000V.

AC Adapter

Device that converts AC(90V~240V) to DC(+12V or 14V)

SMPS(Switching Mode Power Supply)

Switching Mode Power supply. This design technology is used to step up/down the input power by switching on/off

-FRC(Frame Rate Controller)

Technology that change image frame quantity displayed on screen for one second.

Actually TFT-LCD panel require 60 pcs of frame for one second.

so,this technology is needed to convert input image to 60 pcs regardless input frame quantity.

-Image Scaler

Technology that convert various input resolution to other resolution.(ex. 640* 480 to 1024*768)

-Auto Configuration(Auto adjustment)

This is an algorithm to adjust monitor to optimum condition by pushing one key.

-OSD(On Screen Display)

On screen display. customer can control the screen easily with this.

-Image Lock

This means "Fineness adjustment " in LCD Monitor, the features are "Fine" and "Coarse"

-FINE

"Fine" adjustment is used to adjust visibility by control phase difference.

-COARSE

This is a adjustment by tuning with Video colck and PLL clock.

-DVI (Digital Visual Interface)

This provides a high speed digital connection for visual data types that is display technology independent. this interface is primarily focused at providing a connection between a computer and its display device.

-L.V.D.S.(Low Voltage Differential Signaling)

a kind of transmission method for Digital.It can be used from Main PBA to Panel.

-T.M.D.S

(Transition minimized Differential Signaling)

a kind of transmission method for Digital.

It can be used from Video card to Main PBA.

-DDC(Display data channel)

It is a communication method between Host Computer and related equipment.

It can make it Plug and Play between PC and Monitor.

-EDID

Extended Display Identification Data PC can recognize the monitor information as Product data, Product name,Display mode,Serial number and Signal source,etc through DDC Line communicating with PC and Monitor.

-Dot Pitch

The image on a monitor is composed of red, green and blue dots. The closer the dots, the higher the resolution. The distance between two dots of the same color is called the 'Dot Pitch'. Unit: mm

-Vertical Frequency

The screen must be redrawn several times per second in order to create and display an image for the user. The frequency of this repetition per second is called Vertical Frequency or Refresh Rate.

Unit: Hz

Example: If the same light repeats itself 60 times per second, this is regarded as 60 Hz.

-Horizontal Frequency

The time to scan one line connecting the right edge to the left edge of the screen horizontally is called Horizontal Cycle. The inverse number of the Horizontal Cycle is called Horizontal Frequency.

Unit: kHz

-Interlace and Non-Interlace Methods

Showing the horizontal lines of the screen from the top to the bottom in order is called the Non-Interlace method while showing odd lines and then even lines in turn is called the Interlace method.

The Non-Interlace method is used for the majority of monitors to ensure a clear image. The Interlace method is the same as that used in TVs.

-Plug & Play

This is a function that provides the best quality screen for the user by allowing the computer and the monitor to exchange information automatically.

This monitor follows the international standard VESA DDC for the Plug & Play function.

-Resolution

The number of horizontal and vertical dots used to compose the screen image is called 'resolution'.

This number shows the accuracy of the display.

High resolution is good for performing multiple tasks as more image information can be shown on the screen.

Example: If the resolution is 1280 x 1024 , this means the screen is composed of 1280 horizontal dots (horizontal resolution) and 1024 vertical lines (vertical resolution).

14-2 Connecting Your Monitor

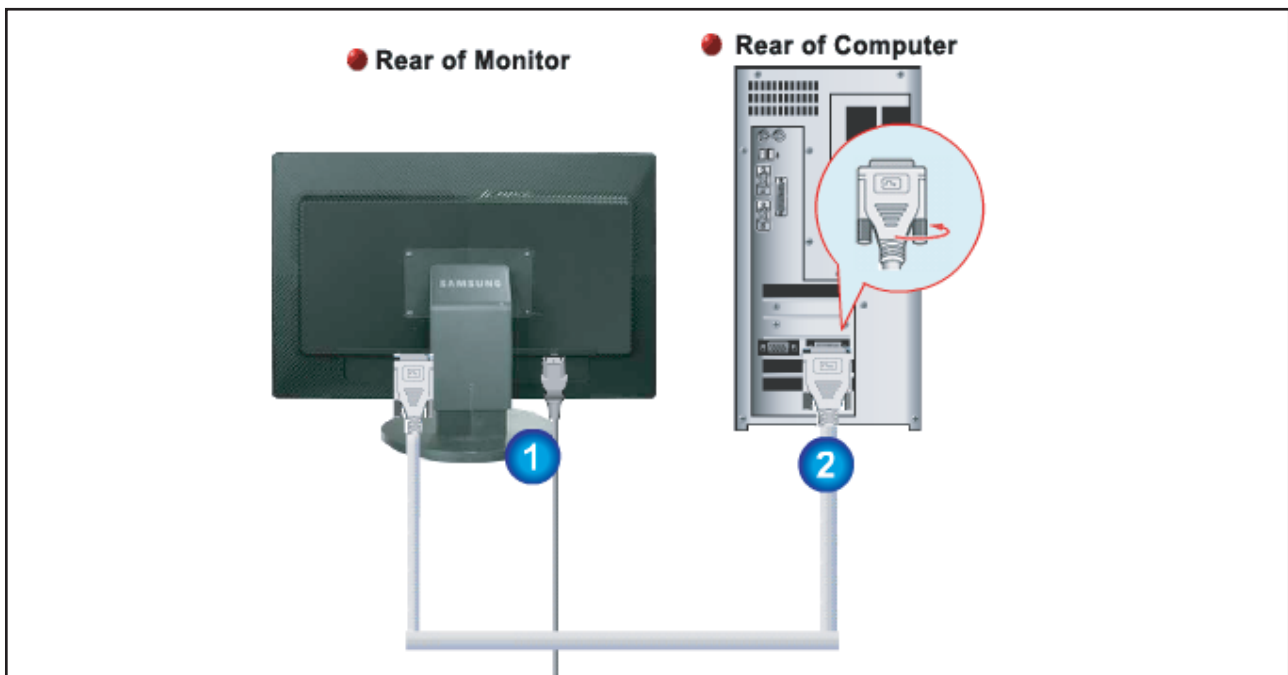

1. Connect the power cord for your monitor to the POWER port on the back of the monitor. Plug the power cord for the monitor into a nearby outlet.
2. Using the DVI-D (Digital) connector on the video card.
Connect the DVI-D cable to the DVI-D port on the back of your monitor.



3. Turn on your computer and monitor. If your monitor displays an image, installation is complete.

14-3 Pin Assignments

Pin No.	Sync Type	24P DVI-D	
1	Rx2-	13	Data Rx3+
2	Rx2+	14	+5V_M
3	GND	15	+5V_M GND
4	Data Rx4-	16	Hot plug D
5	Data Rx4+	17	Rx0-
6	DDC Clock (SCL)	18	Rx0+
7	DDC Data (SDA)	19	GND
8	NC	20	Data Rx5-
9	Rx1-	21	Data Rx5+
10	Rx1+	22	GND
11	NC	23	RxC+
12	Data Rx3-	24	RxC-

14-4 Timing Chart

This section of the service manual describes the timing that the computer industry recognizes as standard for computer-generated video signals.

Table 2-1 Timing Chart

Mode Timing	VESA-Reduced Blanking	
	1280/60Hz 1280X800	2560/60Hz 2560X1600
fH (kHz)	49.306	98.713
A μsec	20.282	10.13
B μsec	0.451	0.119
C μsec	1.127	0.298
D μsec	18.028	9.534
E μsec	0.676	0.179
fV (Hz)	59.91	59.972
O msec	16.692	16.675
P msec	0.122	0.061
Q msec	0.284	0.375
R msec	13.225	16.209
S msec	0.061	0.030
Clock Freq. (MHz)	71.00	268.500
Polarity H.Sync	Positive	Positive
V.Sync	Negative	Negative
<Separate Sync Only>		

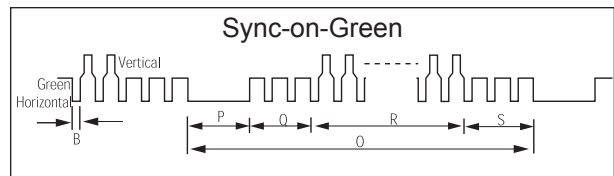
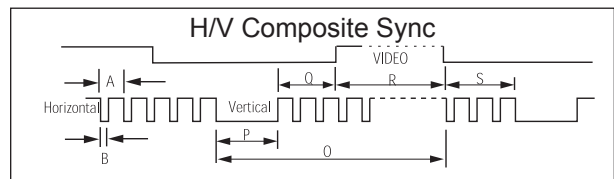
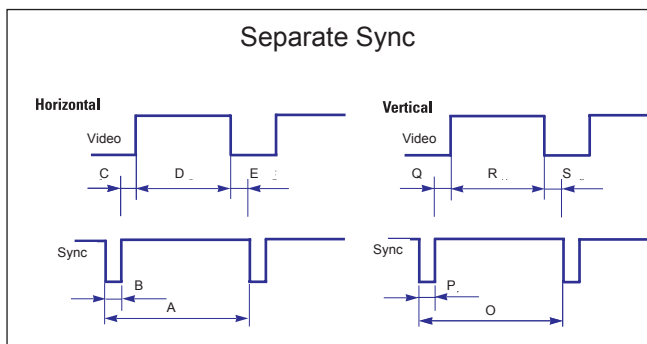

A : Line time total
 B : Horizontal sync width
 C : Back porch
 D : Active time
 E : Front porch

O : Frame time total
 P : Vertical sync width
 Q : Back porch
 R : Active time
 S : Front porch

Horizontal Frequency

The time to scan one line connecting the right edge to the left edge of the screen horizontally is called Horizontal Cycle and the inverse number of the Horizontal Cycle is called Horizontal Frequency. Unit: kHz

Vertical Frequency

Like a fluorescent lamp, the screen has to repeat the same image many times per second to display an image to the user. The frequency of this repetition is called Vertical Frequency or Refresh Rate. Unit: Hz

14-5 Panel Description

Maker	VENDOR_P/N	PANEL_CODE	PANEL_ABB	STICKER_CODE	Remarks
SEC	LT140X1-002	BN07-00004A	SA	BN68-00239H	-
SEC	LT150XS-L01	BN07-00009A	SB		-
SEC	LT150XS-L01-B	BN07-00022A	SC		-
SEC	LTM150XS-L02	BN07-00005A	SD		-
SEC	LT181E2-132	BN07-00001A	SE		-
SEC	LT150XS-T01	BN07-00010A	SF		-
SEC	LTM181E3-132	BN07-00019A	SG		-
SEC	LT170E2-131	BN07-10001D	SH		-
SEC	LT181E2-131	BN07-10001E	SJ		-
SEC	LTM170E4-L01	BN07-00018A	SK		-
SEC	LTM240W1-L01	BN07-00015A	SL		-
SEC	LTM213U3-L01	BN07-00016A	SM		-
SEC	LTM150XH-L01	BN07-00026A	SN		-
SEC	LTM150XH-L03	BN07-00027A	SP		-
SEC	LTM150XS-L01	BN07-00032A	SQ		DELL(ZPD)
SEC	LTM181E4-L01	BN07-00034A	SR		PVA
SEC	LTM170EH-L01	BN07-00036A	SS		TN
SEC	LTM170E5-L01	BN07-00037A	SU		PVA
SEC	LTM150XH-L11	BN07-00041A	SV		-
SEC	LTM213U4-L01	BN07-00039A	SW		PVA
SEC	LTM150XH-L01(ZPD)	BN07-00045A	SX		ZPD
SEC	LTM150XH-L04	BN07-00046A	SY		New panel with high brightness
SEC	LTM170W1-L01	BN07-00047A	SZ		Panel for TV
SEC	LTM150XH-L06	BN07-00053A	EA		Panel for TV/ High luminance for 450cd _ SONY&EOS Team Panel
for TV					
SEC	LTM153W1-L01	BN07-00054A	EB		Use NIKE MODEL
SEC	LTM170EH-L05	BN07-00055A	EC		Panel EOS proj. for high brightness of 17" EH-L05
SEC	LTM170E5-L03	BN07-00056A	ED		Dell 1702FP pro. E4. EH mechanicalCompatible
SEC	LTM190E1-L01	BN07-00057A	EE		DELL 1900 FP
SEC	LTM181E5-L01	BN07-00061A	EF		18" narrow bezel GH18PS
SEC	LTM150XP-L01	BN07-00065A	EG		AMLCD PVA PANEL
SEC	LTM240W1-L02	BN07-00062A	EH		Panel for 15" Wide TV
SEC	LTM170EU-L01	BN07-00071A	EJ		Slim design, TN
SEC	LTM170E5-L04	BN07-00072A	EK		E5-L04 6 bits FRC... for IBM
SEC	LTA220W1-L01	BN07-00074A	EL		Panel for 22" TV
SEC	LTM170E6-L02	BN07-00075A	EM		AMLCD Narrow & slim design 17" PVAmode
SEC	LTM170W1-L01	BN07-00082A	EN		LTM170W1-L01 ZPD panel
SEC	LTM170EH-L01	BN07-00080A	EP		LTM170EH-L01 ZPD panel
SEC	LTM170E5-L01	BN07-00081A	EQ		LTM170E5-L01 ZPD panel
SEC	LTM170EH-L05	BN07-00083A	ER		LTM170EH-L05 ZPD panel
SEC	LTM170E5-L03	BN07-00084A	ES		LTM170E5-L03 ZPD panel
SEC	LTM170EU-L01	BN07-00085A	ET		LTM170EU-L01 ZPD panel
SEC	LTM170E5-L04	BN07-00086A	EU		LTM170E5-L04 ZPD panel
SEC	LTM170E6-L02	BN07-00087A	EV		LTM170E6-L02 ZPD panel
SEC	LTM150XH-L06	BN07-00091A	EW		Color coordinates change for LCD TV
SEC	LTM153W1-L01	BN07-00092A	EX		AMLCD WIDE 15",9/10
SEC	LTM170W1-L01	BN07-00100A	EY		Color Coordinates change code management
SEC	LTM170EH-L05	BN07-00097A	EZ		LTM170E5-L05 Color Coordinates Change Panel Code
SEC	LTA400W1-L01	BN07-00109A	S1		PANEL of AMLCD 40" TV
SEC	LTM153W1-L01	BN07-00110A	S2		Color coordinates change 0.280/0.290, 10000k & ZPD Panel
SEC	LTM150XH-L06	BN07-00111A	S3		Color coordinates change 0.280/0.290, 10000k & ZPD Panel
SEC	LTM170W1-L01	BN07-00112A	S4		Color coordinates change 0.280/0.290, 10000k & ZPD Panel
SEC	LTM170EH-L05	BN07-00113A	S5		Color coordinates change 0.280/0.290, 10000k & ZPD Panel
SEC	LTM220W1-L01	BN07-00114A	S6		ZPD Panel for AMLCD 22" TV
SEC	LTM150XH-L06	BN07-00117A	S7		ZPD Panel code
SEC	LTM153W1-L01	BN07-00118A	S8		ZPD Panel code
SEC	LTM170WP-L01	BN07-00119A	S9		PVA Panel for NIKE
SEC	LTM213U4-L01	BN07-00039A	E1		21.3" NARROW
SEC	LTA260W1-L01	BN07-00121A	E2		VENUS
SEC	LTA220W1-L01	BN07-00074B	E3		Panel B-level panel code for 22" TV Panel
SEC	LTA320W1-L01	BN07-00108A	E4		Panel for AMLCD 32" TV

14 Reference Information

Maker	VENDOR_P/N	PANEL_CODE	PANEL_ABB	STICKER_CODE	Remarks
SEC	LTM213U4-L01	BN07-00124A	E5		NARROW BEZEL 21" PANEL
SEC	LTM170E6-L04	BN07-00129A	E6		HIGHLAND 17" LOW PANEL (Panel only for TCO03)
SEC	LTM190E1-L01	BN07-00088A	E7		LTM190E1-L01 ZPD panel
SEC	M150X4-L06	BN07-00137A	E8		15" Narrow & Slim panel
SEC	LTA170V1	BN07-00139A	E9		17" Panel for Muse 4:3 VGA TV
SEC	LTM190E1-L02	BN07-00128A	E10		New Panel from AMLCDI, Specification : 6bit Driver IC
SEC	LTM170EX-L01	BN07-00143A	E11		Development new Panel from AMLCD
SEC	LTM170E8-L01	BN07-00144A	E12		Development new Panel from AMLCD
SEC	LTM170E6-L04	BN07-00129B	E13		ZPD panel for AMLCD (Panel only for TCO03)
SEC	LTA320W1-L02	BN07-00108B	E14		Creat B-level Panel code for AMLCD 32" TV
SEC	LTM190E1-L03	BN07-00151A	E15		Development new 19" Panel form AMLCD (Panel only for TCO03)
SEC	LTM240W1-L03	BN07-00134A	E16		AMLCD 24" panel development
SEC	LTM190E1-L02	BN07-00128B	E17		New Panel from AMLCD, Specification : 6bit Driver IC(ZPD)
SEC	LTM190E4-L01	BN07-00145A	E18		AMLCD 24" new panel development
SEC	LTM170E8-L01	BN07-00158A	E19		ZPD code derivation
SEC	LTM170EX-L01	BN07-00159A	E20		ZPD code derivation
SEC	LTM190E1-L03	BN07-00151B	E21		Creat new panel code for AMLCD 19" (Panel only for TCO03)
SEC	LTA460H1-L01	BN07-00157A	E22		creat panel code for AMLCD 46" TV
SEC	LTM170EU-L11	BN07-00160A	E23		creat new panel code for AMLCD 17" (Panel only for TCO03)
SEC	LTM240W1-L03	BN07-00134B	E24		24" panel ZPD code derivation
SEC	LTM190E4-L01	BN07-00145B	E25		AMLCD 19" ZPD Panel code derivation
SEC	LTM240W1-L03	BN07-00134B	E26		24" panel ZPD code derivation
SEC	LTM150XO-L01	BN07-00164A	E27		AMLCD 15" XO-L01 new panel development
SEC	LTM150XO-L01	BN07-00164B	E28		AMLCD 15" XO-L01 ZPD code derivation
SEC	LTM170EU-L11	BN07-00160B	E29		AMLCD 17" NEW panel code derivation
SEC	LTA320W2-L01	BN07-00172A	SPZ		AMLCD 32" NEW panel
SEC	LTM213U4-L01	BN07-00124B	SPZ		21.3" Narrow PANEL ZPD Panel derivation
SEC	LTM170EU-L11	BN07-00189A	STH		AMLCD EU-L11 Pb free panel code derivition
SEC	LTM170EU-L11	BN07-00189B	STZ		AMLCD EU-L11 Pb free panel ZPD code derivation
SEC	LTM240W1-L04	BN07-00188A	SPH		24" A-DCC NEW panel
SEC	LTM240W1-L04	BN07-00188B	SPZ		24" A-DCC panel ZPD code derivation
SEC	LTM190EX-L01	BN07-00191A	STH		AMLCD 19" TN NEW Panel
SEC	LTM190EX-L02	BN07-00191B	STZ		AMLCD 19" TN NEW Panel ZPD
SEC	LTA230W1-L02	BN07-00184A	SPZ		AMLCD 23" 16:9 NEW Panel
SEC	LTA260W2-L01	BN07-00185A	SPZ		AMLCD 26" 16:9 NEW Panel
SEC	LTA400W2-L01	BN07-00186A	SPZ		AMLCD 40" 16:9 NEW Panel
SEC	LTM240M1-L01	BN07-00195A	SPH		24" high brightness panel
SEC	LTM150XO-L01	BN07-00197A	STH		AMLCD 15" XO-L01 Pb free panel code
SEC	LTM150XO-L01	BN07-00197B	STZ		AMLCD 15" XO-L01 Pb free panel ZPD code
SEC	LTM170EU-L21	BN07-00202A	STZ		AMLCD EU-L21 ZPD NEW code derivation
SEC	LTA460W2-L03	BN07-00187A	SPZ		BEETOVEN 46"ZPD NEW Panel
SEC	LTM240M1-L01	BN07-00195B	SPZ		24" high brightness panel ZPD code derivation
SEC	M170EX-L21	BN07-00206A	STZ		AMLCD LTM170EX-L21 ZPD NEW code derivation
SEC	LTA460H3-L01	BN07-00200A	SPZ		AMLCD 46" LED BLU panel
SEC	LTM170EU-L15	BN07-00214A	STZ		High brightness For AMLCD EU-L15 TV ZPD NEW code derivation
SEC	LTM170E8-L21	BN07-00218A	SPZ		AMLCD LTM170E8-L21 PVA ZPD NEW code derivation
SEC	LTM190EX-L21	BN07-00222A	STZ		DISPLAY LCD
SEC	LTM201U1-L01	BN07-00190B	SPZ		AMLCD 20.1" Normal panel ZPD code derivation
SEC	LTM190E4-L21	BN07-00223A	SPZ		HAYDN 17" PZD code PANELderivation
SEC	LTA570H1-L01	BN07-00196A	SPZ		AMLCD 57" NEW Panel
SEC	LTM150XO-L21	BN07-00229A	STZ		AMLCD 15" XO-L21 8ms panel code
SEC	LTA260W2-L11	BN07-00239A	SPZ		AMLCD 26" 16:9 7Line NEW Panel
SEC	LTA400WS-LH1	BN07-00245A	SPZ		AMLCD 40" 16:9 SPVA 90% NEW Panel
SEC	LTM213U6-L01	BN07-00231A	SPZ		AMLCD 21.3" PVA NEW Panel Code
SEC	LTM213U6-L01	BN07-00231B	SPH		AMLCD 21.3" PVA Panel HPD Code
SEC	LTA320WS-LH2	BN07-00244A	SPZ		AMLCD 32" 16:9 SPVA 90% NEW Panel
SEC	LTA400WS-LH1	BN07-00245A	SPZ		AMLCD 40" 16:9 SPVA 90% NEW Panel
SEC	LTM190M2-L01	BN07-00227A	STZ		AMLCD 19" TN Wide NEW Panel Code
SEC	LTM201UX-L01	BN07-00249A	STZ		AMLCD 20.1" TN NEW Panel Code
SEC	LTM240M1-L02-A05	BN07-00250A	SPZ		24" High brightness Slim panel ZPD code derivation
SEC	LTA320W3-L02	BN07-00219A	SPZ		AMLCD 32" NEW FFL Panel

Maker	VENDOR P/N	PANEL_CODE	PANEL_ABB	STICKER_CODE	Remarks
SEC	LTA320W2-L11	BN07-00259A	SPZ		IP Board for AMLCD 32" 16:9 NEW Panel
SEC	LTA460WS-L02	BN07-00252A	SPZ		AMLCD 46" 16:9 SPVA 72% NEW Panel
SEC	LTA400WT-L01	BN07-00264A	SPZ		-
SEC	LTM240M2-L02	BN07-00267A	SPZ		All LCD Monitor 24" wide SPVA ZPD NEW code derivation
SEC	LTM210M2-L02	BN07-00230A	SPZ		-
SEC	LTA320WT-L11	BN07-00257A	SPZ		-
SEC	LTM190EX-L21-G	BN07-00274A	STZ		AMLCD 19" TN Glare NEW Panel Code
SEC	LTA320WT-L14	BN07-00247A	SPZ		-
SEC	LTM190M2-L01-D016	BN07-00280A	STZ		AMLCD 19" TN Wide change Gamma Panel Code
SEC	LTM190EX-L31	BN07-00279A	STZ		AMLCD 19" TN NEW Panel Code
SEC	LTM190M2-L02	BN07-00287A	STZ		AMLCD 19" TN Wide High brightness NEW Panel Code
SEC	LTA400WS-L01	BN07-00246A	SPZ		Display-LCD (Div) 07AH
SEC	LTA460WS-L01	BN07-00311A	SPZ		-
SEC	LTM190E4-L31	BN07-00316A	SPZ		-
SEC	LTM170EX-L31	BN07-00278A	STZ		AMLCD LTM170EX-L31 ZPD
SEC	LTA460HS-LH1	BN07-00291A	SPZ		AMLCD 46" 16:9 FHD / 60Hz / 8bit / SPVA 92%
SEC	LTA320WT-LF1	BN07-00323A	SPZ		-
SEC	LTA460WT-L02	BN07-00284A	SPZ		AMLCD 46" 16:9 HD / 60Hz / 8bit / SPVA 72% /
SEC	LTA400WH-LH1	BN07-00271A	SPZ		AMLCD 40" 16:9 SPVA 92% 10bit 120Hz
SEC	LTM240M1-L02-D015	BN07-00331A	SPZ		-
SEC	LTM300M1-P01	BN07-00326A	SPZ		
CPT	CLAA150XG09	BN07-00141A	PA		CPT 15" Monitor new panel development
CPT	CLAA170EA02	BN07-00148A	PB		17" CPT NEW development panel
CPT	CLAA170EA02	BN07-00148B	PC		17" CPT ZPD panel code derivation
CPT	CLAA150XG09	BN07-00141B	PTZ		CPT 15" panel ZPD code derivation (GOYA-PJT)
CPT	CLAA150XP01	BN07-00173A	PTH		CPT 15" PSWG code derivation
CPT	CLAA150XP01	BN07-00173B	PTZ		CPT 15" PSWG panel ZPD code derivation
CPT	CLAA170EA07	BN07-00174A	PTH		CPT 17" PSWG code derivation
CPT	CLAA170EA07	BN07-00174B	PTZ		CPT 17" PSWG type New Panel code
CPT	CLAA170EA07Q	BN07-00220A	PTZ		CPT 17" PSWG R/T 8msec code derivation
CPT	CLAA170EA07Q	BN07-00220B	PTH		CPT 17" PSWG R/T 8msec HPD code derivation
CPT	CLAA150XP01F	BN07-00236A	PTZ		CPT 15" PSWG panel ZPD & Lead free code derivation
CPT	CLAA201WA03Q	BN07-00269A	PTZ		CPT 20.1" wide TN ZPD New code derivation
CPT	CLAA320WA01	BN07-00276A	PMZ		CPT 32" 16:9 MVA 8bit 60Hz / Panel brown
CPT	CLAA170ES01	BN07-00261A	PTZ		CPT 17" Slim TN ZPD Type New code derivation
CPT	CLAA070VA02	BN07-00265A	PTZ		CPT Panel code derivation for Digital Album
TOSHIBA	LTM15C419(A)	BN07-00002A	TA		-
TOSHIBA	LTM15C423(B)	BN07-00006A	TB		-
TOSHIBA	LTM18C161	BN07-00008A	TC		-
TOSHIBA	LTM15C443	BN07-00031A	TD		-
TOSHIBA	LTM15C458	BN07-00043A	TE		-
TOSHIBA	LTM15C458S	BN07-00077A	TF		TSB 15" high brightness Panel
TOSHIBA	LTM15C458	BN07-00078A	TG		Toshiba ZPD panel
TOSHIBA	LTM15C458S	BN07-00099A	TH		TSB LTM15C458S (ZPD)
HANNSTAR	HSD150MX41A(A)	BN07-00020A	NA		TTL type
HANNSTAR	HSD150MX12	BN07-00030A	NB		TTL type
HANNSTAR	HSD170ME13	BN07-00180A	NTH		Hannstar 17" TN new panel development
HANNSTAR	HSD170ME13	BN07-00180B	NTZ		Hannstar 17" TN new panel development ZPD code derivation
HANNSTAR	HSD190ME12	BN07-00210A	NTZ		Hannstar 19" TN new panel development
HANNSTAR	HSD150MX17-A	BN07-00226A	NTZ		Hannstar 15" slim panel ZPD code derivation
HANNSTAR	HSD190ME12-A10	BN07-00256A	NTZ		Hannstar 19" TN PSWG 8ms new panel development
HANNSTAR	HSD190ME13-D11	BN07-00270A	NTZ		Hannstar 19" TN Slim 5ms new panel development
HANNSTAR	HSD190ME13-A13	BN07-00317A	NTZ		
TORISAN	TM150XG-22L03(A)	BN07-00021A	RA		-
TORISAN	TM150XG-26L06	BN07-00042A	RB		-
TORISAN	TM181SX-76N01	BN07-00048A	RC		-
TORISAN	TM150XG-26L06	BN07-00059A	RD		15" XGA TN MODE(ZPD)

14 Reference Information

Maker	VENDOR P/N	PANEL_CODE	PANEL_ABB	STICKER_CODE	Remarks
TORISAN	TM290WX-71N31	BN07-00063A	RE		RS24NS (TORISAN 29" NEW PANEL)
TORISAN	TM396WX-71N31	BN07-00064A	RF		RS24NS (TORISAN 40" NEW PANEL)
TORISAN	TM150XG-26L09	BN07-00073A	RG		Panel for 15" TV
TORISAN	TM150XG-26L10	BN07-00089A	RH		L10(change except D/IC) ZPD
TORISAN	TM150XG-26L10	BN07-00090A	RJ		L10 NORMAL
TORISAN	TM190SX-70N01	BN07-00098A	RK		Torisan 19" Panel
TORISAN	TM181SX-76N01	BN07-00106A	RL		ZPD Panel code
TORISAN	TM190SX-70N01	BN07-00107A	RM		ZPD Panel code
TORISAN	TM290WX-71N31	BN07-00115A	RN		Color Coordinates change panel for TORISAN 29" TV
TORISAN	TM396WX-71N31	BN07-00116A	RP,Q		Color Coordinates change panel for TORISAN 40" TV
TORISAN	TM220WX-71N31	BN07-00125A	RR		Development TORISAN 22" TV PANEL (ZPD)
TORISAN	TM220WX-71N31	BN07-00127A	RS		Development TORISAN 22" TV PANEL (HPD)
TORISAN	TM396WX-71N32A	BN07-00150A	RT		120V inverter Exclusive panel
TORISAN	TM190SX-70N02	BN07-00154A	RMH		Torisan 6bit panel code Derivation
TORISAN	TM190SX-70N02	BN07-00154B	RMZ		Torisan 6bit panel code Derivation
TORISAN	TM150XG-A01	BN07-00162A	RTH		Torisan 15" Narrow & Slim panel development
TORISAN	TM150XG-A01	BN07-00162B	RTZ		Torisan 15" N&S panel ZPD code derivation
SHARP	LQ181E1DG11(A)	BN07-10001C	PA		-
SHARP	LQ150X1LW71	BN07-00067A	PB		SHARP 15" PVA PANEL
SHARP	LQ370T3LZ41	BN07-00216A	FAZ		Rome2
HITACHI	TX38D12VC0CAA(A)	BN07-00003A	HA		-
HITACHI	TX43DVCOCAB	BN07-00060A	HB		17" SXGA PVA MODE
HITACHI	TX43D15VC0CAB	BN07-00101A	HC		ZPD Panel
HITACHI	TX51D11VC0CAB	BN07-00122A	HD		20.1" NARROW
HITACHI	TX54D11VC0CAB	BN07-00123A	HE		21.3" NARROW
HITACHI	TX80D12VC0CAB	BN07-00169A	HIZ		Development new panel for Hitachi 32" TV (ZPD)
HITACHI	TX54D11VC0CAB	BN07-00123B	HIZ		Hitachi 21.3"ZPD panel
IBM	ITSX94S	BN07-00017A	IA		-
UNIPAC	UM170E0	BN07-00028A	UA		Loaded by cisdba
HYUNDAI	HT15X13	BN07-00035A	DA		-
HYUNDAI	HT17E11-200	BN07-00049A	DB		TN MODE
HYUNDAI	HT17E11-300	BN07-00093A	DC		HT17E11-300 ZPD panel
HYUNDAI	HT17E11-400	BN07-00094A	DD		HT17E11-400 normal panel
HYUNDAI	HT17E11-400	BN07-00095A	DE		HT17E11-400 ZPD panel code
HYUNDAI	HT17E12	BN07-00096A	DF		HT17E12 (Narrow & slim Design)
HYUNDAI	HT17E12	BN07-00105A	DG		ZPD Panel code
HYUNDAI	HT15X15-D00	BN07-00146A	DH		Development for Ares 15" Hydis TV
HYUNDAI	HT15X15-D01	BN07-00146B	DJ		Derivation panel HPD for Ares 15" Hydis TV
HYUNDAI	HT17E13-100	BN07-00167A	DTH		PINEHURST-2(IBM) PJT 17" HYDIS PANEL Derivation
HYUNDAI	HT17E13-100	BN07-00167B	DTZ		PINEHURST-2(IBM) Hydis 17" ZPD code Derivation
HYUNDAI	HT170EX1-100	BN07-00240A	DTZ		17" EX compatible Hydis Slim panel development
HYUNDAI	HT201V01-100	BN07-00263A	DTZ		Hydis 20.1" 4:3 VGA Mode TN NEW Panel
HYUNDAI	HT170EX1-101	BN07-00266A	DTZ		17" EX compatible Hydis Slim panel multi channel IC NEW
Derivation					
ACER	L170E3	BN07-00044A	AA		TN(ADT)
ACER	M170EN05	BN07-00076A	AB		AU 17" Panel (Narrow & slim design)
ACER	M170EN05	BN07-00102A	AC		ZPD Panel code
ACER	M190EN02	BN07-00170A	AMH		AU Monitor 19" new panel development (P19-1S)
ACER	M190EN02	BN07-00170B	AMZ		AU 19" ZPD code derivation (ZPD)
ACER	M170EN06	BN07-00171A	ATH		AU Monitor 17" New panel development
ACER	T260XW01	BN07-00163A	AMZ		AU 26" new panel development (NF26EO)
ACER	A201SN01	BN07-00177A	ATZ		AU TV panel 20.1" TN SVGA new panel development
ACER	M170EN06	BN07-00171B	ATZ		AU Monitor 17" ZPD code Derivation
ACER	T315XW01	BN07-00194A	AMZ		New AU 32"
ACER	M170EG01	BN07-00192A	ATH		AU TN PSWG type New Panel code

Maker	VENDOR P/N	PANEL_CODE	PANEL_ABB	STICKER_CODE	Remarks
ACER	M170EG01	BN07-00192B	ATZ		AU TN PSWG type New Panel ZPD Derivation code
ACER	M190EN04	BN07-00203A	ATH		AU Monitor 19" ZPD New code Derivation
ACER	T260XW02	BN07-00208A	AMZ		AUO 26"
ACER	M170EG01 V8	BN07-00221A	ATZ		AU TN PSWG type New Panel (8msec) ZPD Derivation code
ACER	T260XW02	BN07-00233A	AMZ		AUO 26" New Panel (Cosmetic spec down grade)
ACER	T315XW01	BN07-00234A	AMZ		AUO 32" New Grade (Cosmetic spec down grade)]
ACER	M190EN03	BN07-00224A	AMZ		AU Monitor 19" MVA New code Derivation
ACER	T315XW01	BN07-00237A	AMZ		New LCD TV VE project : delete DBEF sheet * Panel, model division
ACER	T315XW01	BN07-00238A	AMZ		New LCD TV VE project : delete DBEF sheet + 'A-'
ACER	M201UN02 V3	BN07-00168A	AMZ		-
ACER	M201UN02 V3	BN07-00168B	AMH		-
ACER	M190EN04 V7	BN07-00248A	ATZ		AU Monitor 19" TN Glare ZPD New code Derivation
ACER	A070VW01	BN07-00235A	ATZ		New Panel code Derivation for Digital Album
ACER	T315XW01	BN07-00253A	AMZ		LCD TV VE item model * Panel, Model division add version:
ACER	T260XW02	BN07-00254A	AMZ		AUO 26" VE item apply model
ACER	M170EU01	BN07-00260A	ATZ		AUO 17" Slim TN ZPD Type New code Derivation
ACER	T370XW01	BN07-00255A	AMZ		for ROME 37" model development
ACER	T315XW02(V3),	BN07-00324A	AMZ		-
ACER	A201SN02 V5	BN07-00314A	ATZ		-
CHIMEI	M170E3-L01	BN07-00050A	CA		TN PANEL
CHIMEI	M150X3-L01	BN07-00051A	CB		COMPATIBLE
CHIMEI	M170E4-L01	BN07-00052A	CC		MVA PANEL
CHIMEI	M150X2-L01	BN07-00066A	CD		CHIME 15" PVA PANEL
CHIMEI	M150X3-L01	BN07-00079A	CE		Chimei ZPD panel
CHIMEI	M170E3-L01	BN07-00103A	CF		ZPD Panel code
CHIMEI	M170E4-L01	BN07-00104A	CG		ZPD Panel code
CHIMEI	V296W1-L01	BN07-00120A	CH		MVA
CHIMEI	M170E6-L02	BN07-00126A	CJ		HIGHLAND 17" LOW PANEL
CHIMEI	M190E2-L01	BN07-00131A	CK		GH19AS,BS CHIMEI PANEL
CHIMEI	M150X4-L06	BN07-00137A	CL		15" Narrow & Slim panel
CHIMEI	M170E6-L01	BN07-00133A	CM		2003-03-11 vendor change
CHIMEI	M170E6-L01	BN07-00133B	CN		ZPD derivation panel
CHIMEI	V201V1-T01	BN07-00135A	CP		CHIMEI 20.1" panel development
CHIMEI	M170E6-L02	BN07-00126B	CQ		HIGHLAND 17" LOW PANEL ZPD derivation panel
CHIMEI	M170E6-L05	BN07-00152A	CR		CMO 17" new panel development code
CHIMEI	M170E6-L05	BN07-00152B	CS		CMO 17" ZPD panel code derivation
CHIMEI	M150X4-L06	BN07-00137B	CT		Chimei 15" Narrow & Slim panel ZPD derivation
CHIMEI	M170E5-L05	BN07-00165A	CTH		CMO 17" new panel development code (GOYA2-PJT)
CHIMEI	M170E5-L05	BN07-00165B	CTZ		CMO 17" ZPD panel(GOYA2-PJT)
CHIMEI	V230W1-L02	BN07-00209A	CMZ		CMO 23" new development
CHIMEI	V320B1-L01	BN07-00207A	CMZ		CMO 32" new development
CHIMEI	V270W1-L01	BN07-00136A	CMZ		CHI MEI 27" panel development
CHIMEI	M190E5-L0A	BN07-00213A	CTZ		-
CHIMEI	M190E3-L0A	BN07-00212A	CMZ		CMO M190E3-L0A MVA Type New code derivation
CHIMEI	M170E7-L01	BN07-00232A	CTZ		CMO 17" Slim TN ZPD Type New code derivation
CHIMEI	M190A1-L01	BN07-00228A	CTZ		CMO 19" Wide TN ZPD Type New code derivation
CHIMEI	V201V1-T03	BN07-00275A	CTZ		CMO 20.1" (V201V1-T01) VE model
CHIMEI	M201P1-L01	BN07-00268A	CTZ		CMO 20.1" TN ZPD derivation
CHIMEI	M220Z1-L01	BN07-00321A	CTZ		
CHIMEI	M190E5-L0G	BN07-00337A	CTZ		
NEC	SVA150XG04TB	BN07-00225A	BTZ		SVA NEC 15" panel ZPD code
NEC	SVA170SX01TB	BN07-00272A	BTZ		SVA NEC 17" panel ZPD code Brown

Memo

4 Troubleshooting

- Notes:**
- Before troubleshooting, setup the PC's display as below.
 - Resolution: 2560 x 1600
 - H-frequency: 98.7 kHz
 - V-frequency: 60 Hz
 - If no picture appears, make sure the power cord is correctly connected.
 - Check the following circuits.
 - No raster appears: Function PBA, Main PBA, Inverter, Panel
 - 5V develop but no screen: Main PBA
 - +24V, +18V does not develop: SMPS, Main PBA

4-1 No Power (SMPS)

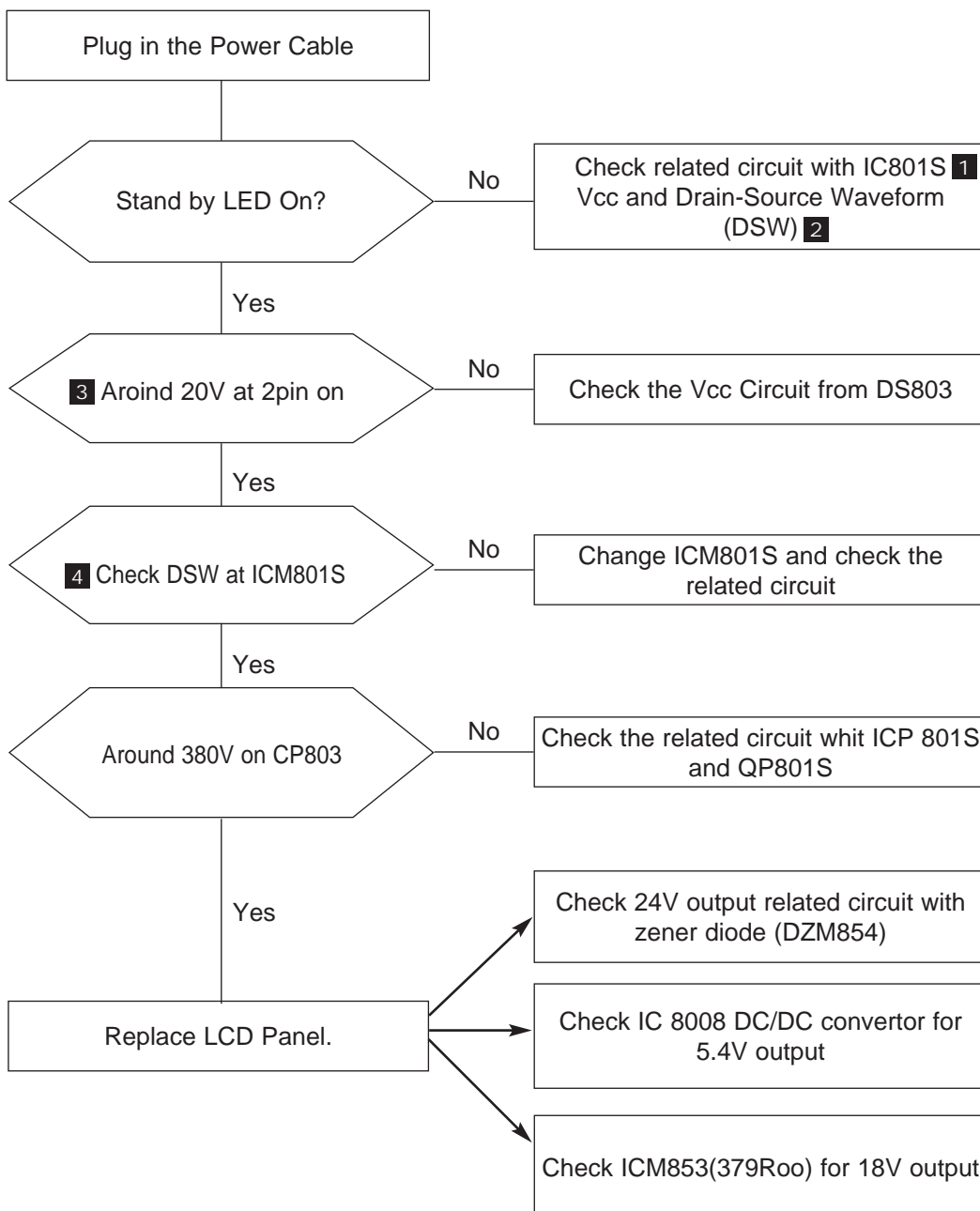

WAVEFORMS

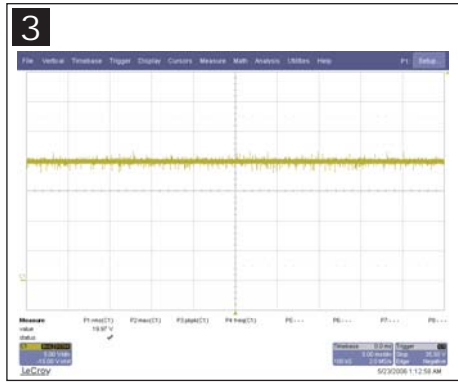
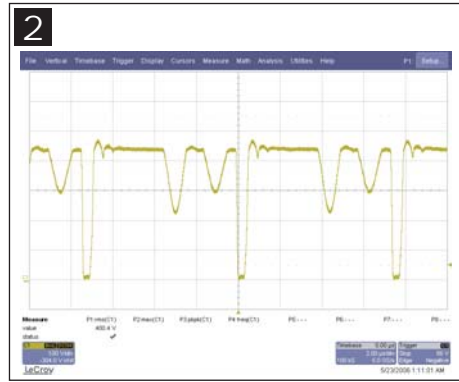

4-2 No Power (Main)

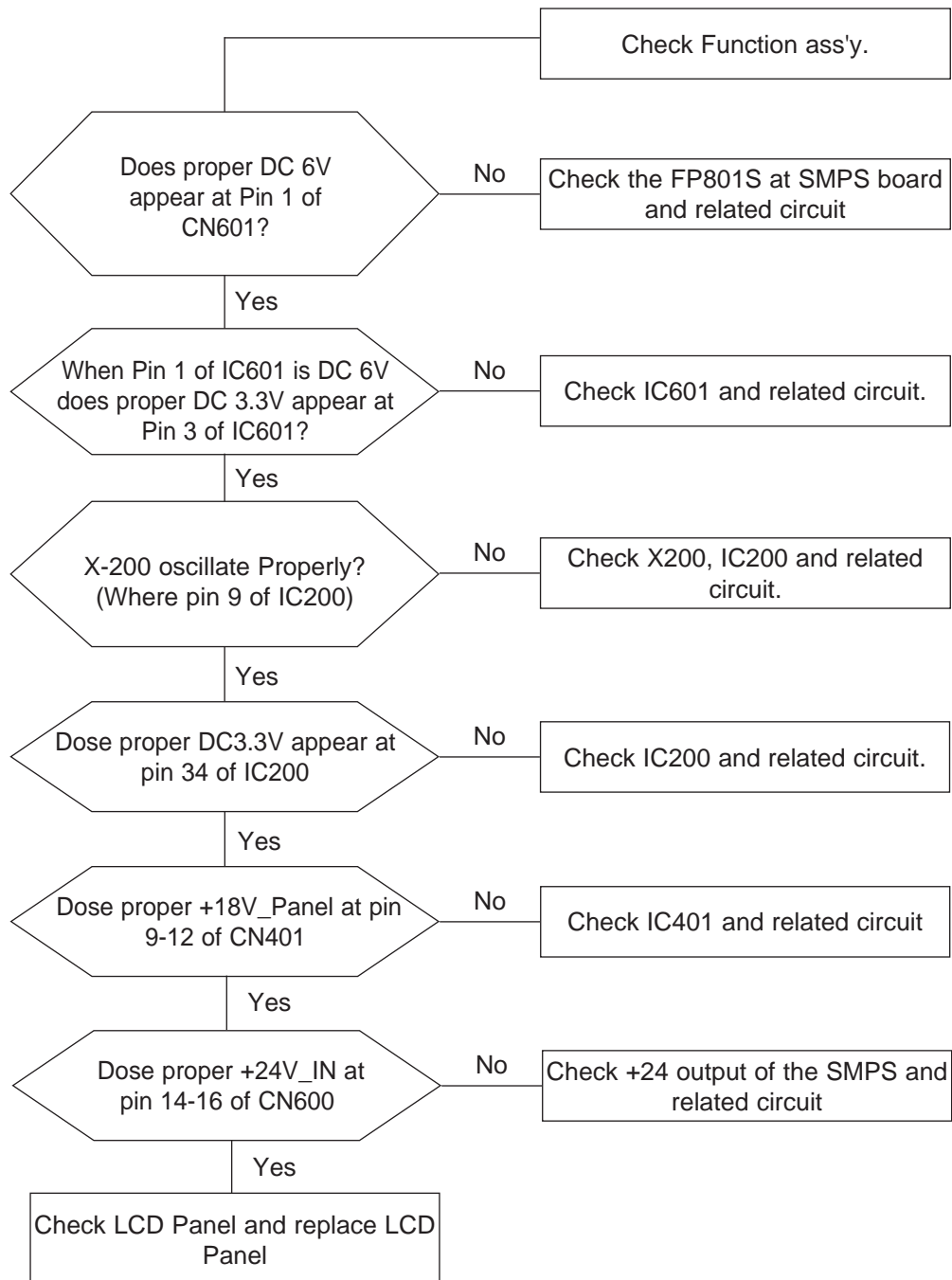

4-3 No Video (DIGITAL)

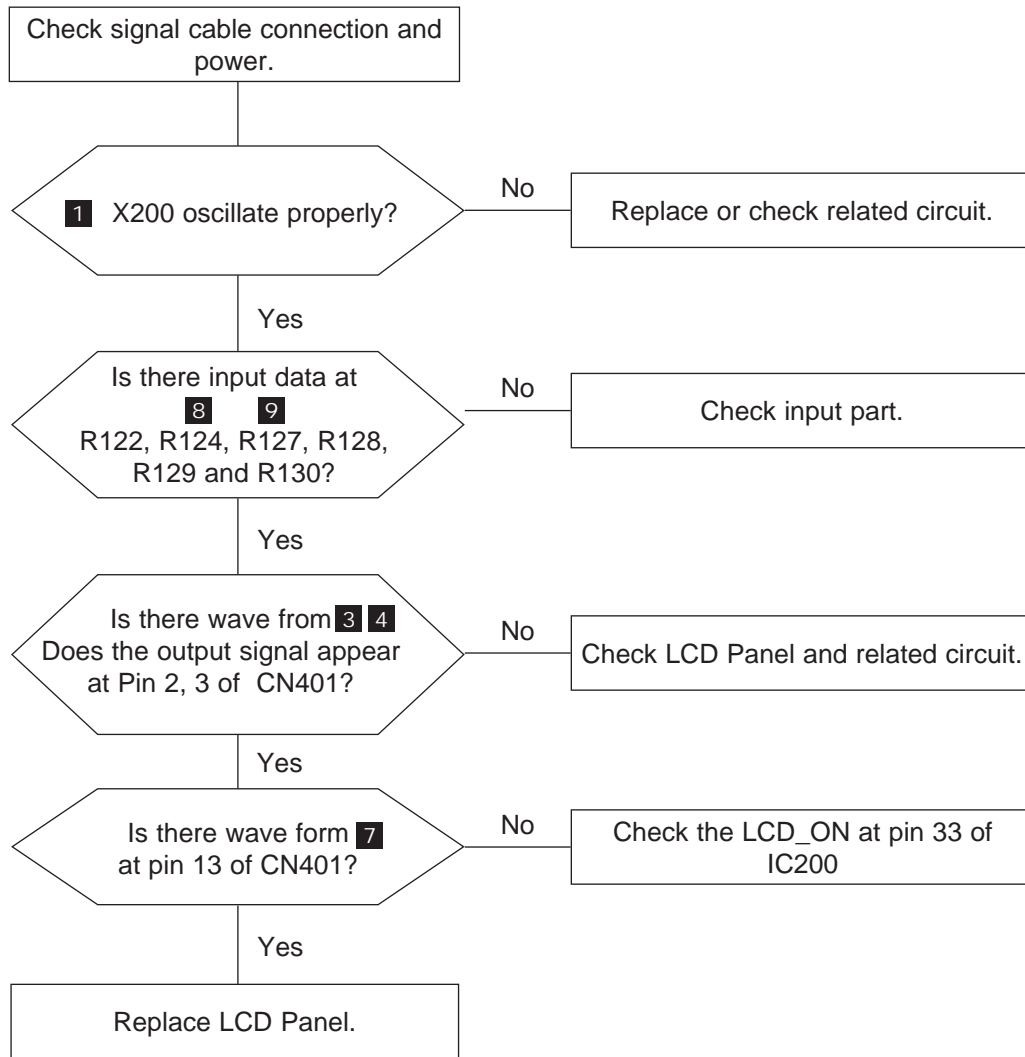

WAVEFORMS

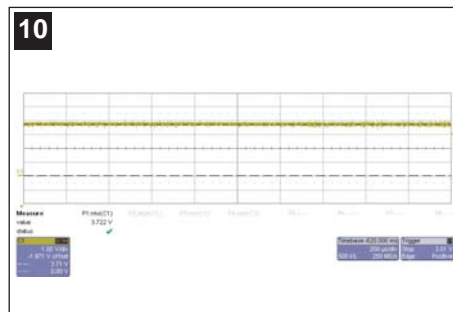
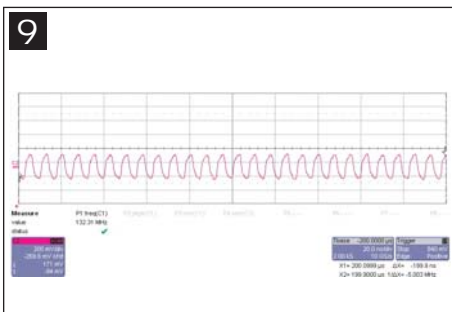
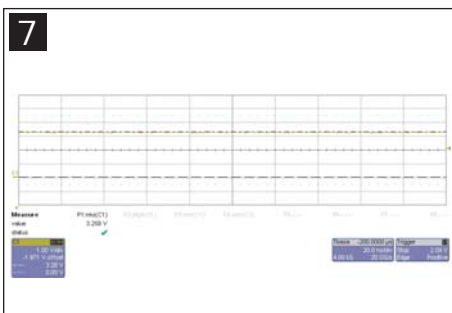
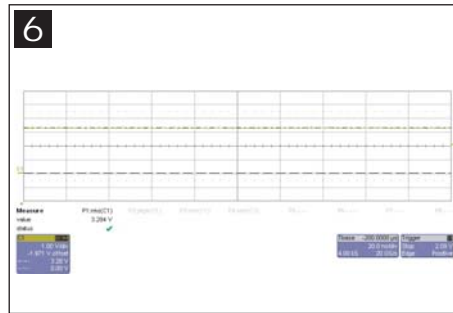
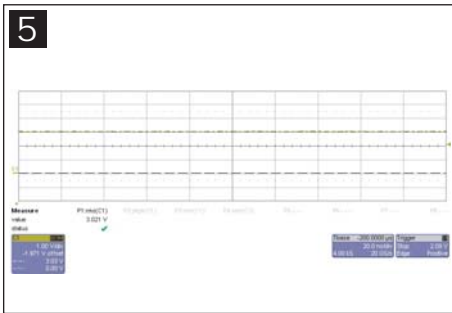
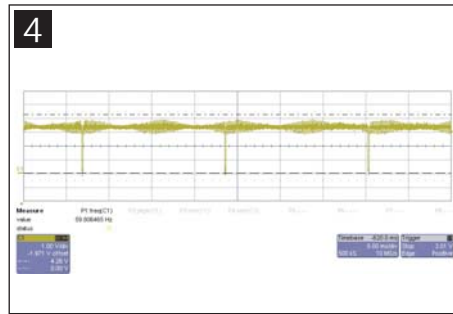
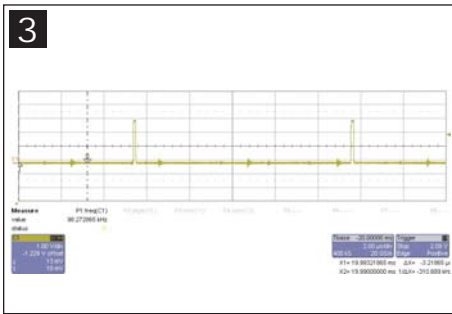
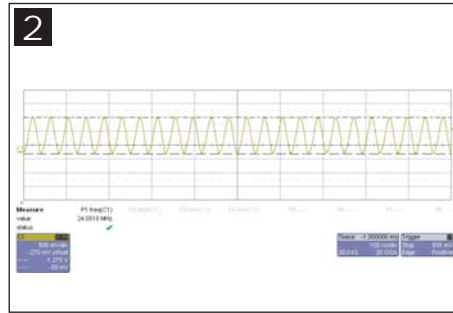
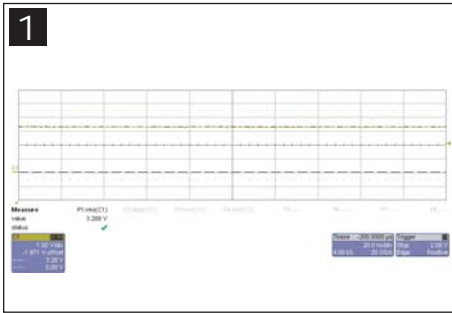

Memo

8 Wiring Diagram

8-1 Wiring Diagram (Main PCB)

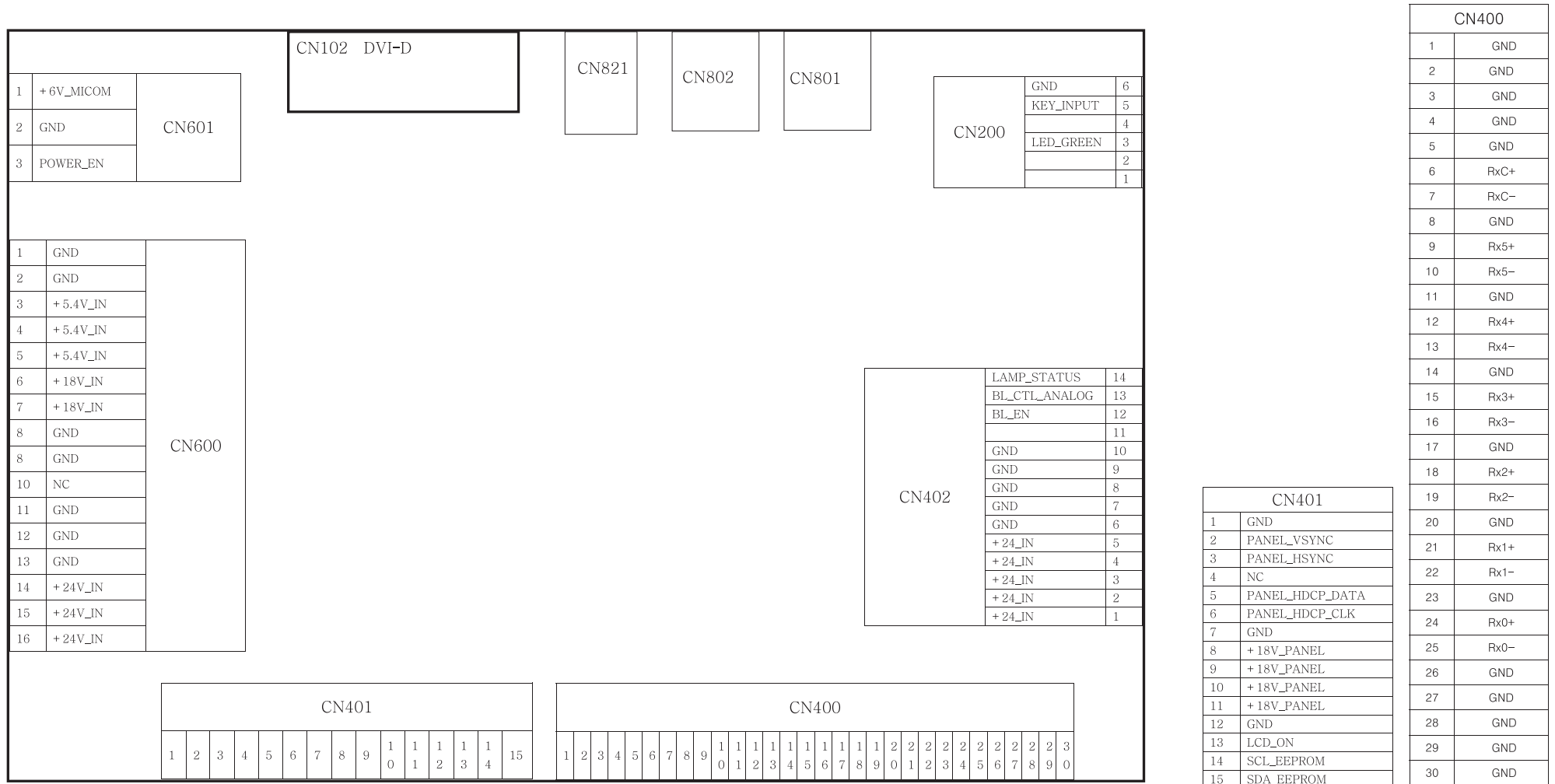

8-2 Wiring Diagram (SMPS PCB)

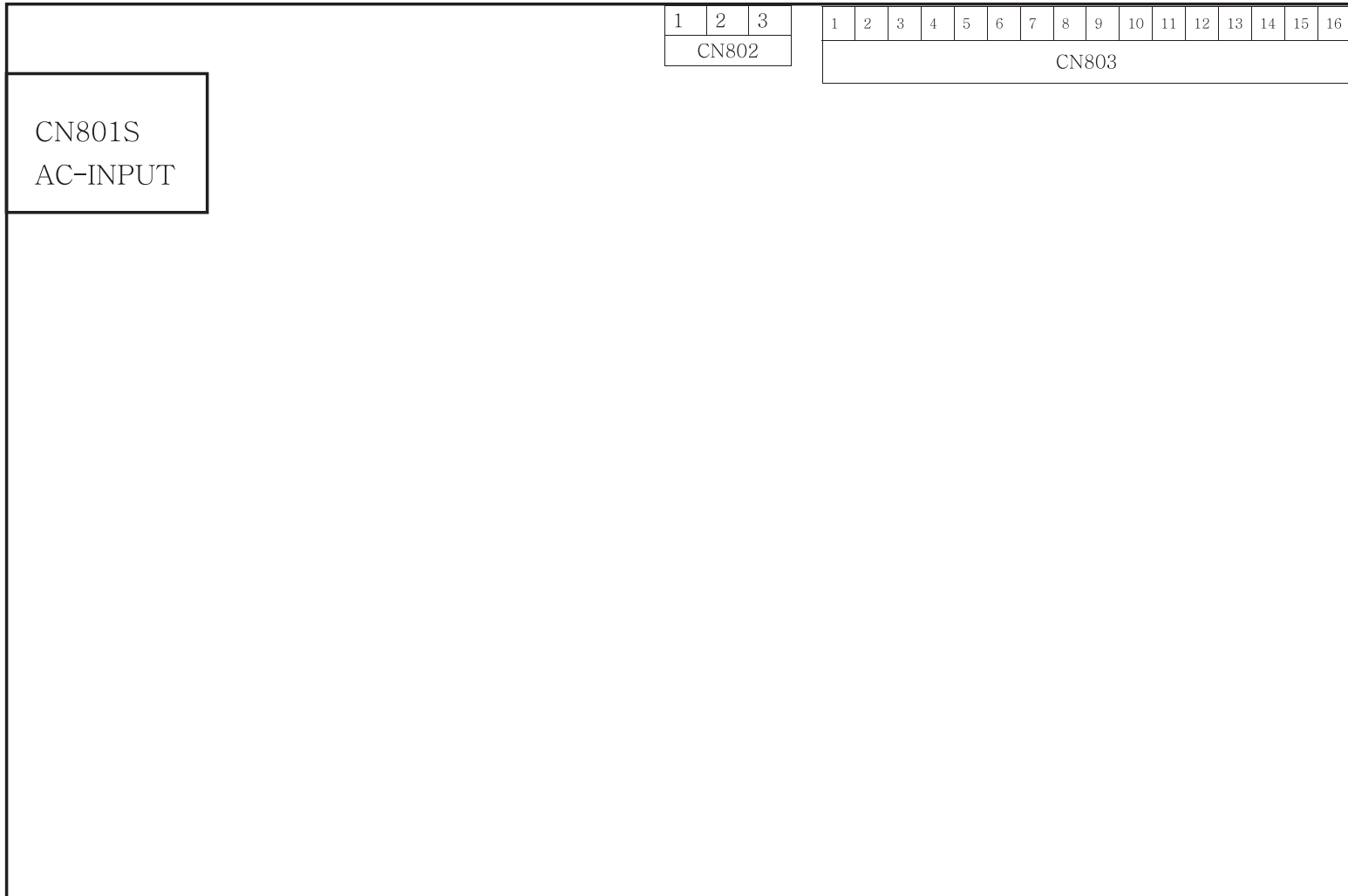

1	+6V_MICOM	CN802
2	GND	
3	POWER_EN	

1	GND	CN803
2	GND	
3	+5.4V_IN	
4	+5.4V_IN	
5	+5.4V_IN	
6	+18V_IN	
7	+18V_IN	
8	GND	
8	GND	
10	NC	
11	GND	
12	GND	
13	GND	
14	+24V_IN	
15	+24V_IN	
16	+24V_IN	

9 Schematic Diagrams

- This Document can not be used without Samsung's authorization.

9-1 Schematic Diagrams

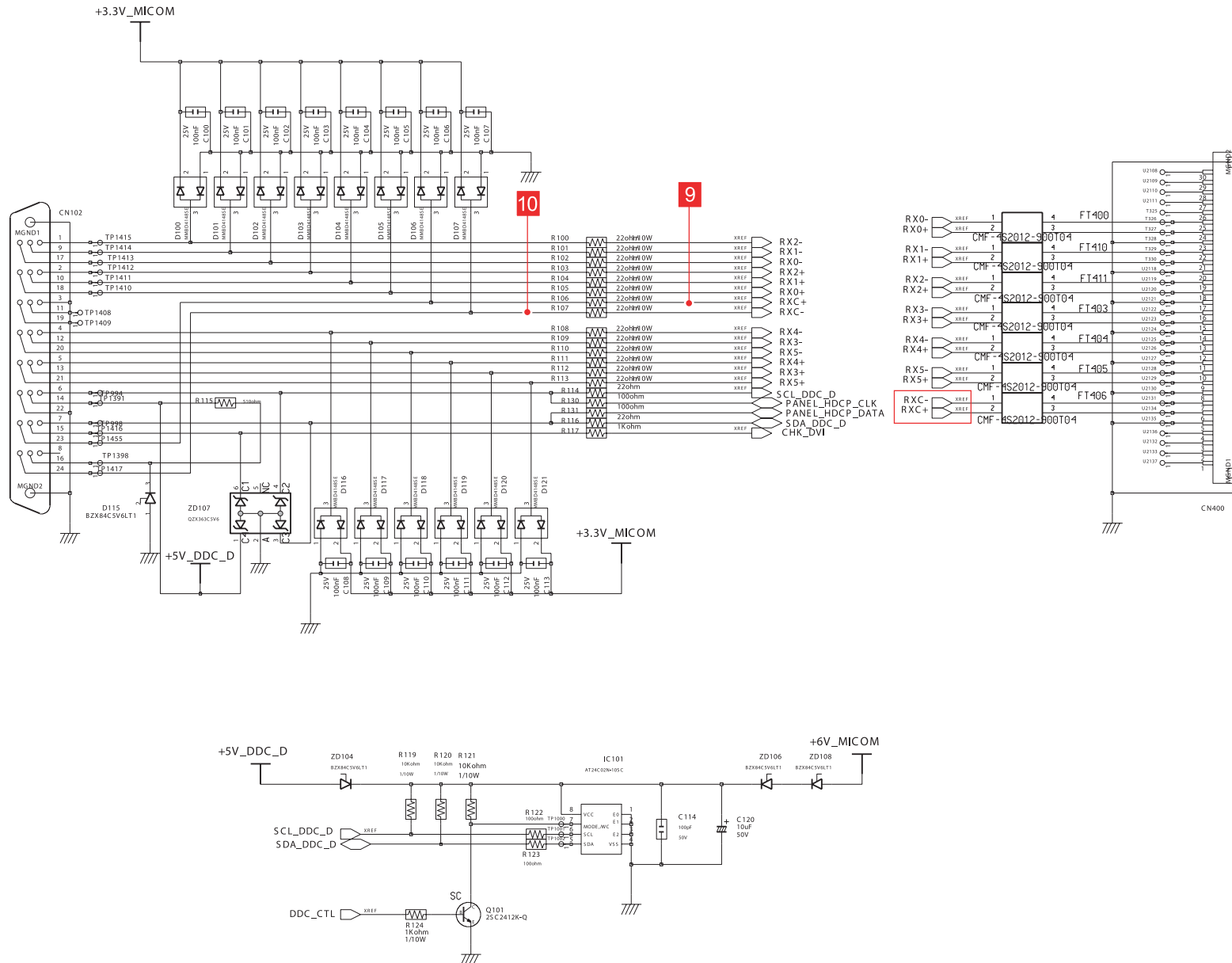

9-2 Connection Diagrams

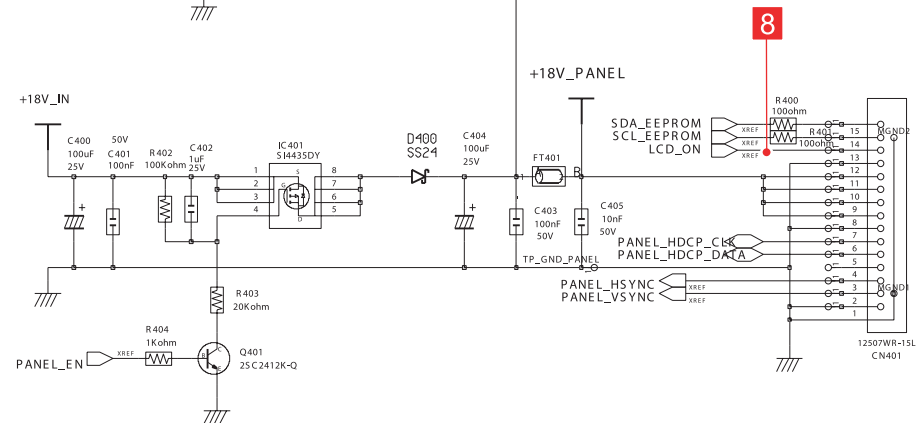
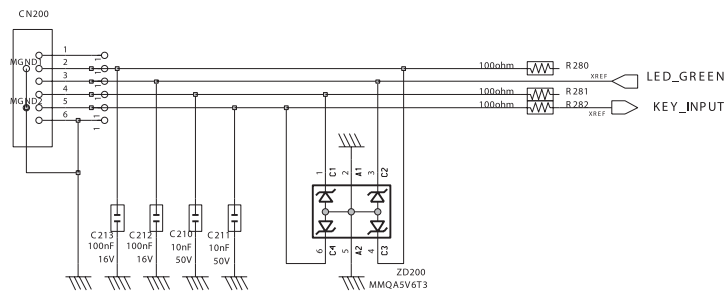
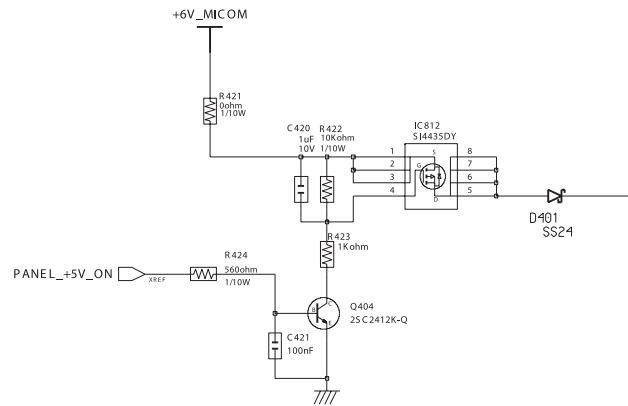
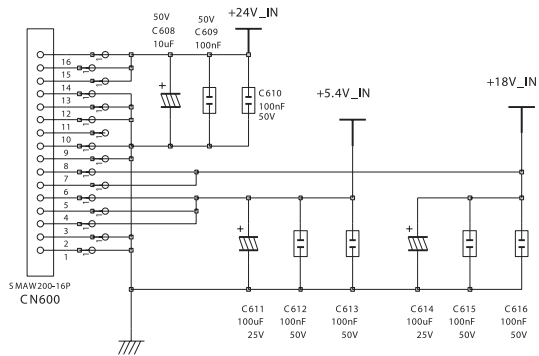
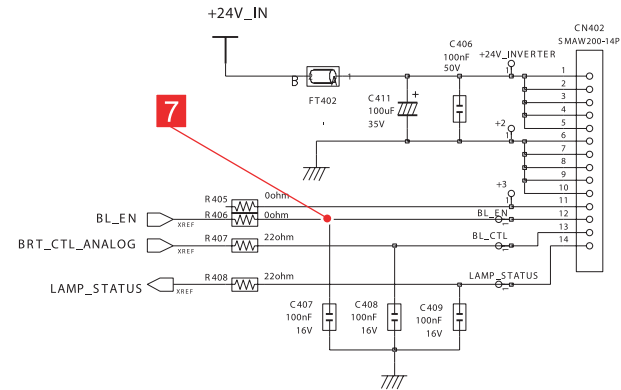
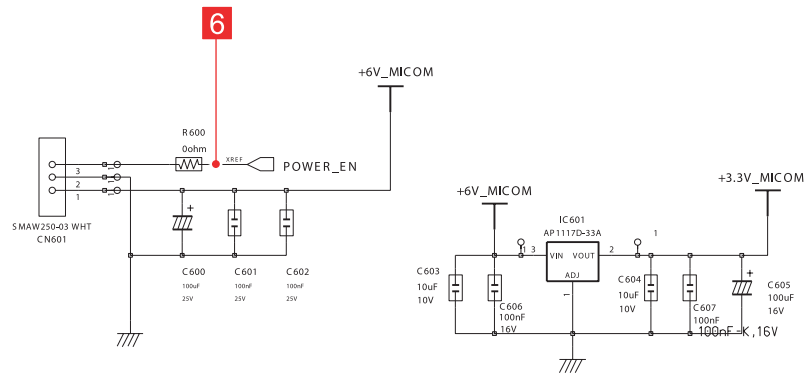

9-3 Microm Diagrams

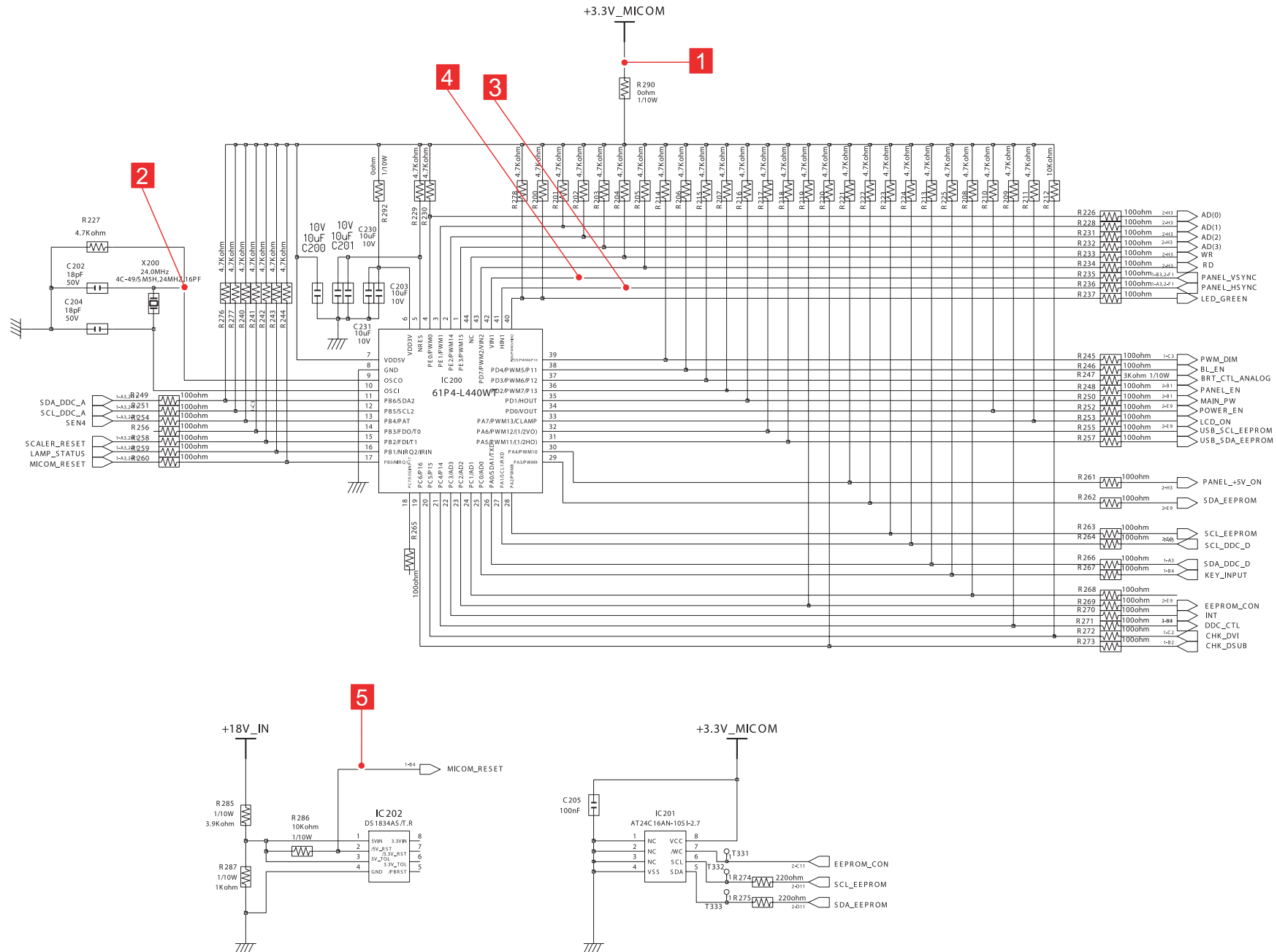

9-4 Power inverter Schematic Diagrams

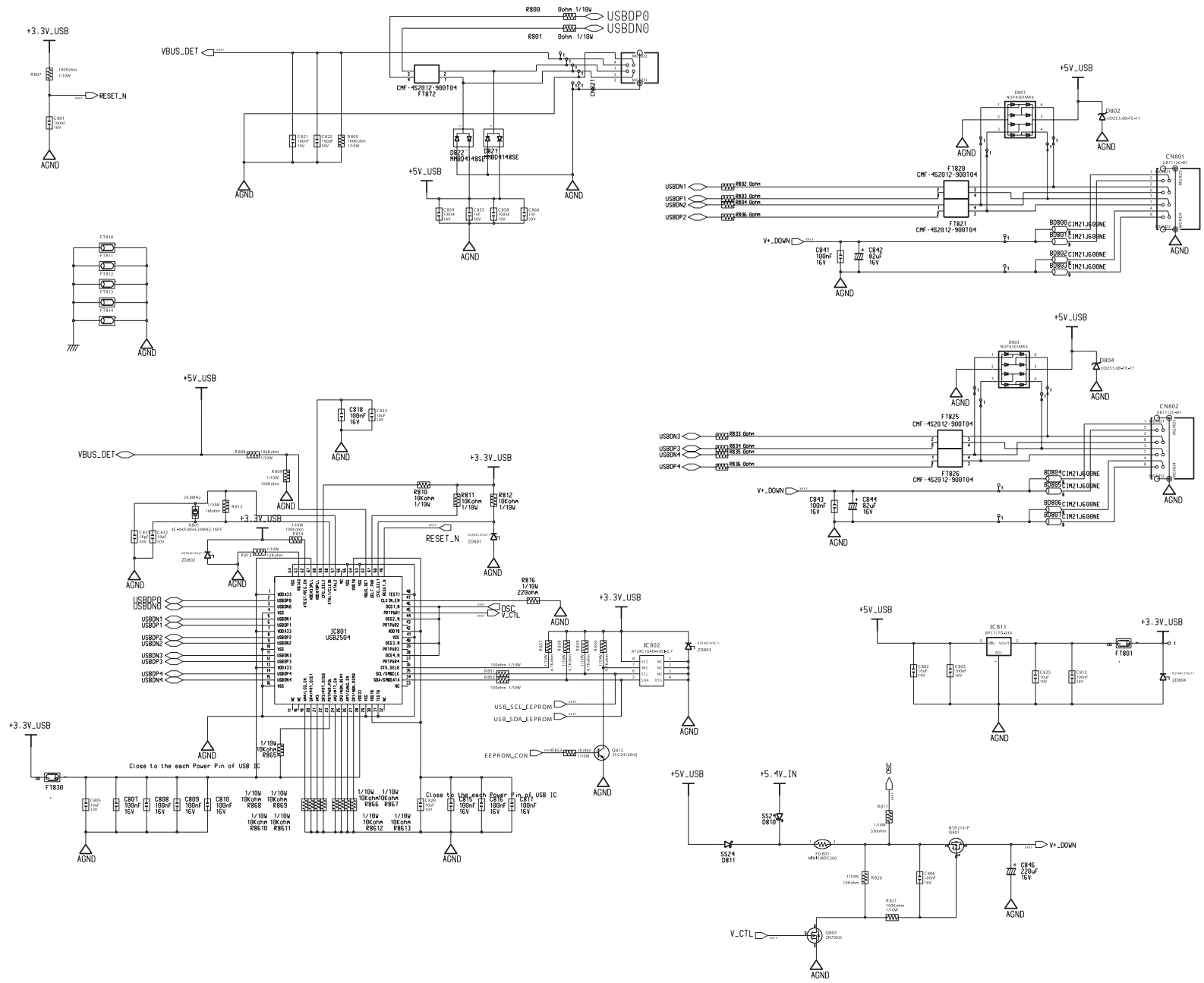

WAVEFORMS



9-5 SMPS Schematic Diagrams

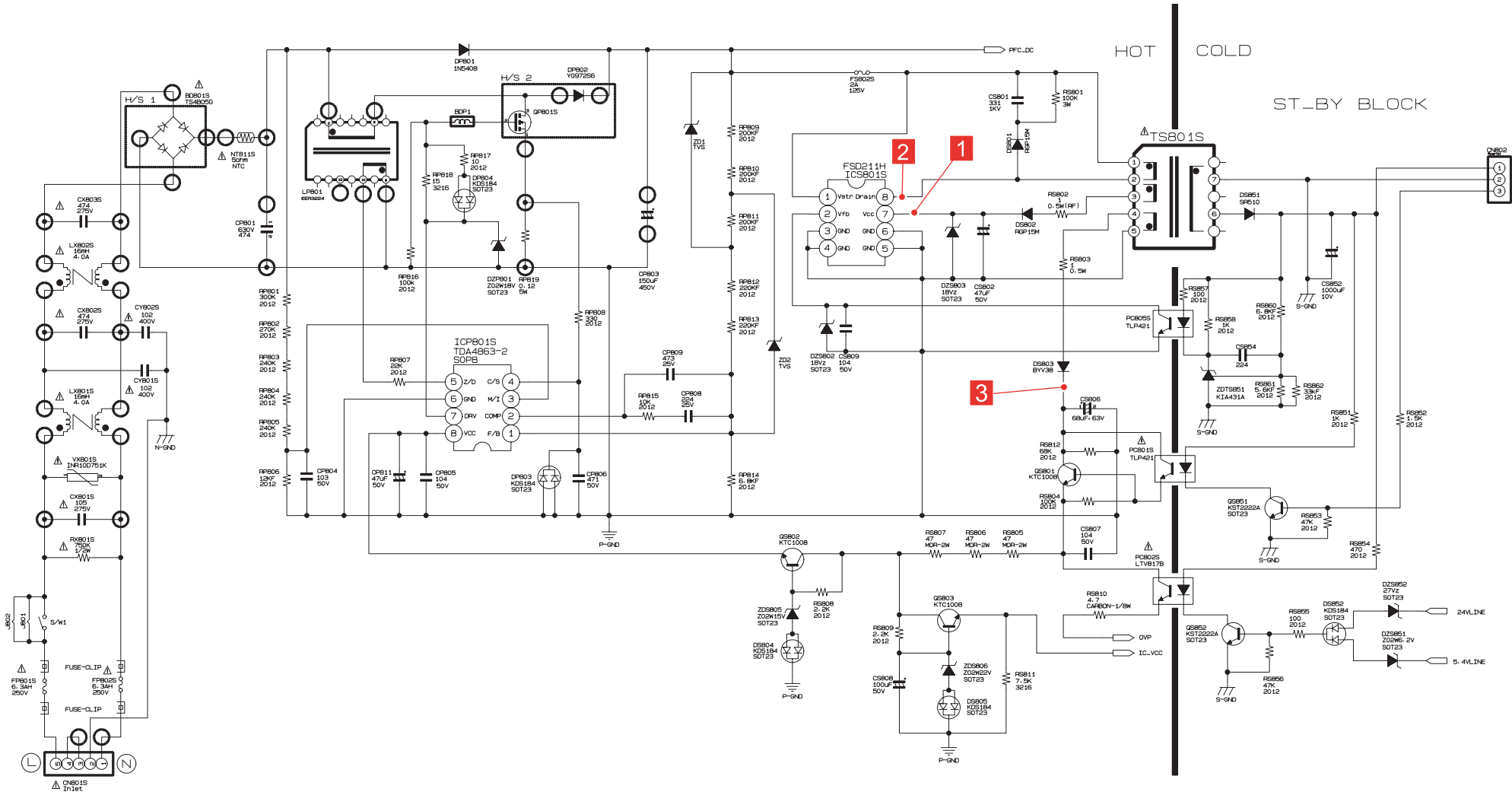

9-6 SMPS Schematic Diagrams

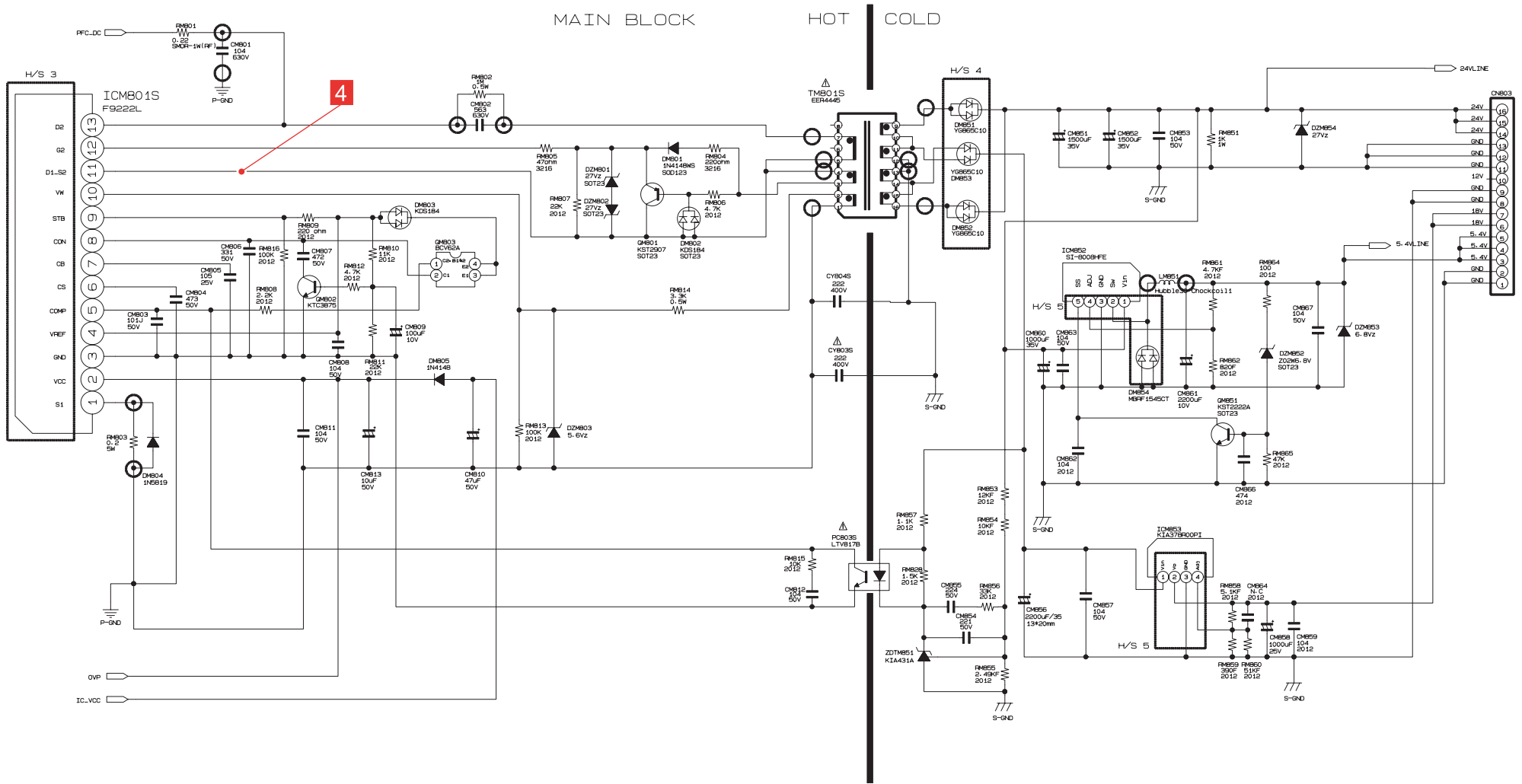

WAVEFORMS

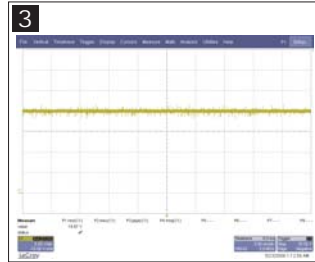
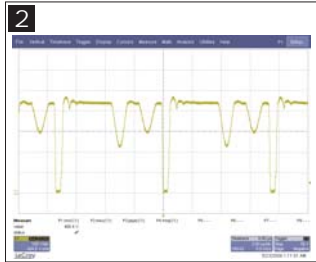

Free Manuals Download Website

<http://myh66.com>

<http://usermanuals.us>

<http://www.somanuals.com>

<http://www.4manuals.cc>

<http://www.manual-lib.com>

<http://www.404manual.com>

<http://www.luxmanual.com>

<http://aubethermostatmanual.com>

Golf course search by state

<http://golfingnear.com>

Email search by domain

<http://emailbydomain.com>

Auto manuals search

<http://auto.somanuals.com>

TV manuals search

<http://tv.somanuals.com>