



Digital Phone **User Guide**

DS-5021D / DS-5014D



DS-5021D



DS-5014D

COPYRIGHT

This manual is proprietary to SAMSUNG Electronics Co., Ltd. and is protected by copyright. No information contained herein may be copied, translated, transcribed or duplicated for any commercial purposes or disclosed to third parties in any form without the prior written consent of SAMSUNG Electronics Co., Ltd.

TRADEMARKS

OfficeServ™ is the trademark of SAMSUNG Electronics Co., Ltd.
Product names mentioned in this document may be trademarks and/or registered trademarks of their respective companies.

This manual may be changed for product improvement, standardization and other technical reasons without prior notice.

For further information on the updated manual or the content contained in the manual, contact your Authorised Samsung Reseller.

<http://www.samsungdocs.com>

Enterprise IP Solutions

OfficeServ Digital Phone **User Guide**

DS-5021D / DS-5014D / DS-5014S / DS5038S / DS-5007S



SAFETY CONCERNS

For product safety and correct operation, the following information must be given to the operator/user and shall be read before the installation and operation.

Conventions



WARNING

WARNING

Provides information or instructions that you should follow in order to avoid personal injury or fatality.



CAUTION

CAUTION

Provides information or instructions that you should follow in order to avoid a service failure or damage to your phone.



NOTE

Indicates additional information for reference.

Symbols



Caution

Indication of a general caution



Restriction

Indication of a prohibited action for the phone



Instruction

Indication for commanding a specifically required action



WARNING



The handset receiver on the phone may retain metallic objects. Care should be taken when using the handset in the vicinity of small metal objects.



Avoid placing objects containing water such as vases, cups, cosmetics, and medicines near the phone.

Moisture in the phone may cause a fire and electric shocks.



Do not place the phone in a dusty area or areas with extreme or volatile changes in temperature.

It may cause a fire or electric shocks.



Do not install the phone near a heater or flames (cigarette lighter, heating apparatus, etc.).

It may cause a fire or electric shocks.

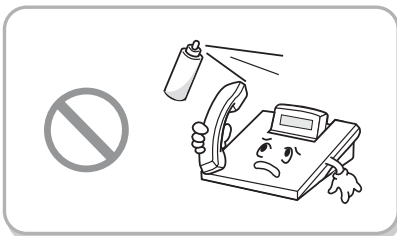

Do not use flammable solvent or materials near the phone. Do not store them near the phone.

It may cause a fire or electric shocks.



CAUTION

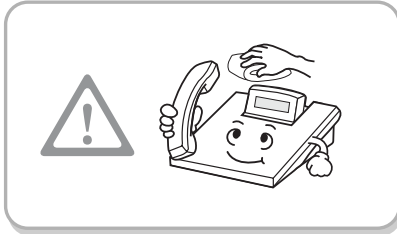

**Use a soft dry cloth to clean the phone.
Do not use any chemical solvents like wax, benzene, alcohol, thinner, aerosols, lubricant, or detergent.**

The use of chemicals on the phone may cause fading/discoloring or damage to the parts.

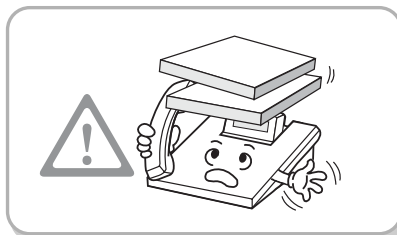

Do not place heavy things on the phone.

It may cause damage to some parts.

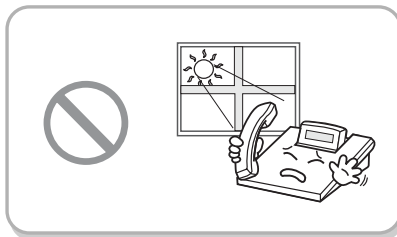

Do not install the phone on an unstable surface or in direct sunlight.

It may cause severe damage to the plastic case of the phone, and reduced the performance of your phone.

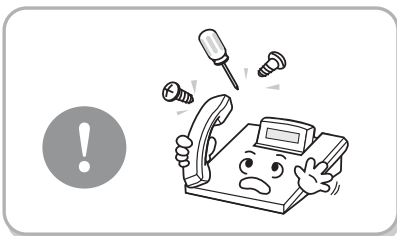

Do not separate, repair or remodel the phone arbitrarily.

If a repair is needed, please contact your Authorised Samsung Reseller.

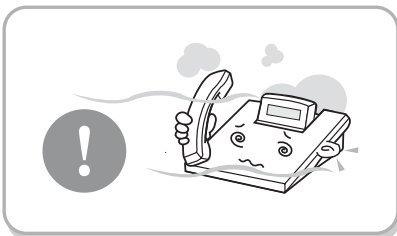

If the phone makes excessive noise, emits an odour, or smoke, immediately unplug the phone and call your Authorised Samsung Reseller.

TABLE OF CONTENTS

SAFETY CONCERNS

Conventions.....	2
Symbols.....	2
Warning	3
Caution	4

PREPARATION

Main Features.....	8
Checking Parts in the Package.....	10
Front View of the DS-5021D / 5014D	11
Bottom View of the DS-5021D / 5014D	14
Connecting Lines to the Phone.....	18

THINGS YOU SHOULD KNOW

About Stations and Trunk Lines	24
Selecting System Functions	25
Entering Characters.....	30
Configuring My Phone	32
Volume Adjustment.....	37
Types of Signal Tone	39
Telephone Status Indicator	40
Button LED	40

BASIC FEATURES

Before Making / Answering a Call.....	42
Intercom Calls.....	43
Outside Calls	49
Intercom / Outside Calls	58

CONVENIENT FEATURES

Do Not Disturb	78
Call Forwarding.....	80
Paging and Messaging	88
Alarm Features	101
Use with the Door Phone	105
Executive / Secretary Hot Line.....	107
Group Listening.....	108
Account Code	109
Locking Your Phone	110
Off-Hook Voice Announcement	111
In Group / Out Of Group	113
Mute.....	114
Background Music	115
Timer.....	116

APPLICATION MENUS

Navigation Buttons.....	120
Main Menus	123
Reviewing and Calling Recently Called Numbers	124
Reviewing and Calling Recently Received Numbers	125
Reviewing and Calling Speed Dial Numbers.....	126
Reviewing and Calling Numbers by Name.....	127
Setting Forward Type and Number	129
Setting Alarm Reminders	131

ANNEX

Troubleshooting	134
Product Specifications.....	136

PREPARATION

Main Features	8
Checking Parts in the Package	10
Front View of the DS-5021D / 5014D	11
Bottom View of the DS-5021D / 5014D	14
Connecting Lines to the Phone	18



Main Features

Application menu

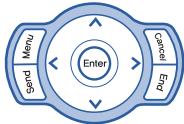

This button allows you to access the digital phone's menu functions. The menu functions include the recent outgoing call log, incoming call log, system directory functions, transferring incoming calls, inquiry of speed dial numbers, and alarm function.

Speed Dial



For frequently used phone numbers, you can press one speed dial button to make a call to the speed dial number.

Pickup



You can answer a call at another extension.

Automatic Redial/Retry



When your call is important but your party is busy on another call, you can use automatic redial/retry function. The digital phone redials the called number automatically until your party is free to take your call.

Hold

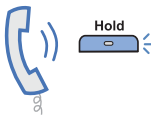

You can use the Hold feature when you need something or another call arrives. Use this button to temporarily hold the current call until you are ready to resume the call. You can even pickup a held call at another station.

Conference Calls



This button is used when multiple parties need to be connected simultaneously during a phone conversation. Up to five parties including you can be connected in a conference call.

Call Forwarding

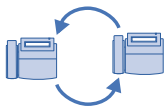

If you cannot answer an incoming call, the call can be forwarded to another extension (unconditionally, while you are busy on a call, or when you are away from your phone).

Do Not Disturb

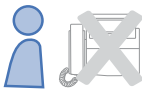

When you do not want to be disturbed, the DND function can be set to block incoming calls and the phone will not ring. Your calls can be forwarded to another station when you do not wish to be disturbed.

Paging



If you have an urgent announcement to make, or you wish to locate a colleague, you can page through the speaker of other stations, or through optional external speakers.

Call ID



When there is an incoming call, the caller ID or name will be displayed on the LCD screen. You can see who is calling before answering the call and respond accordingly.

Checking Parts in the Package

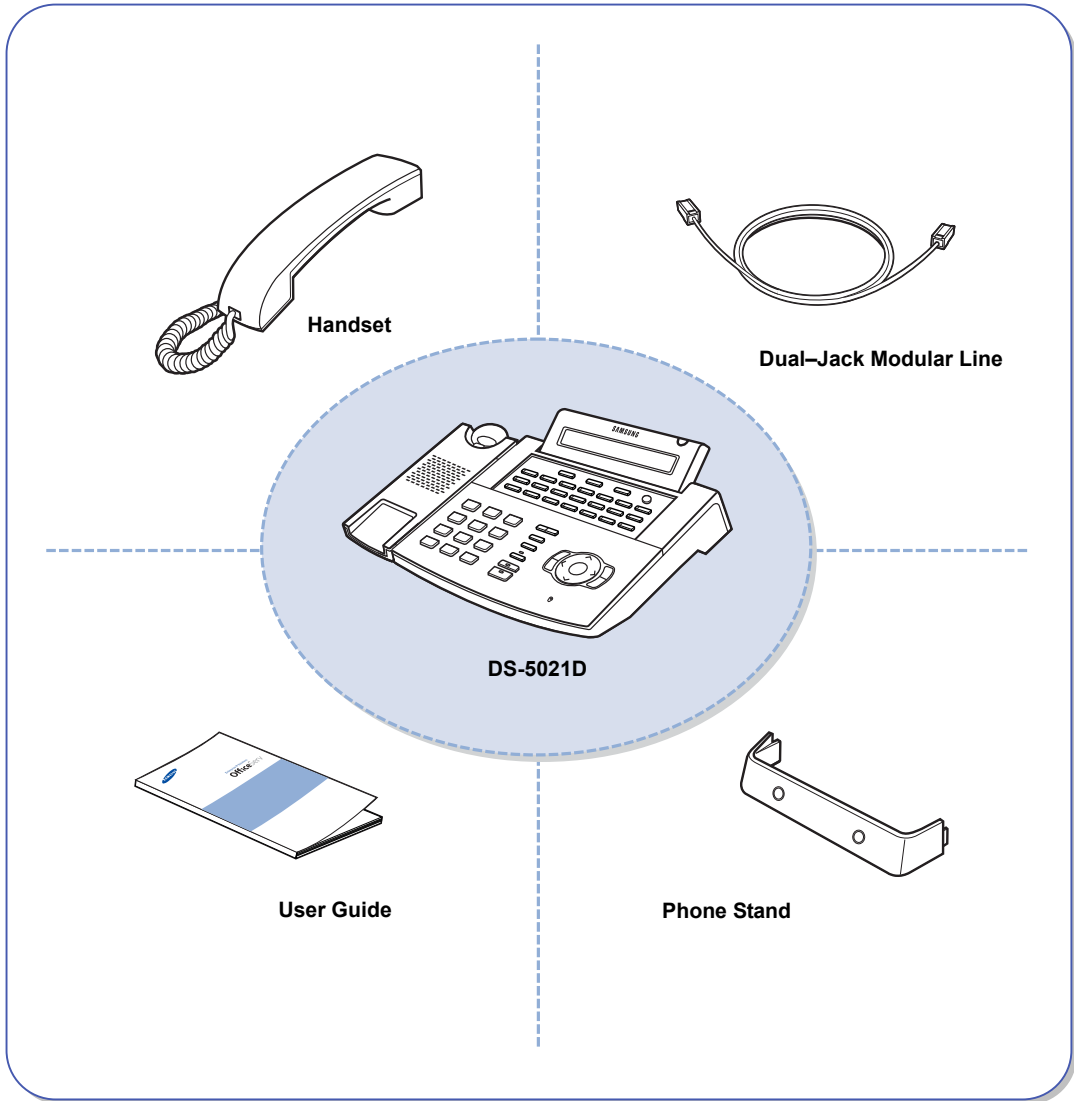

NOTE

Please contact your Authorised Samsung Reseller if any item above is missing or damaged.

Front View of the DS-5021D / 5014D

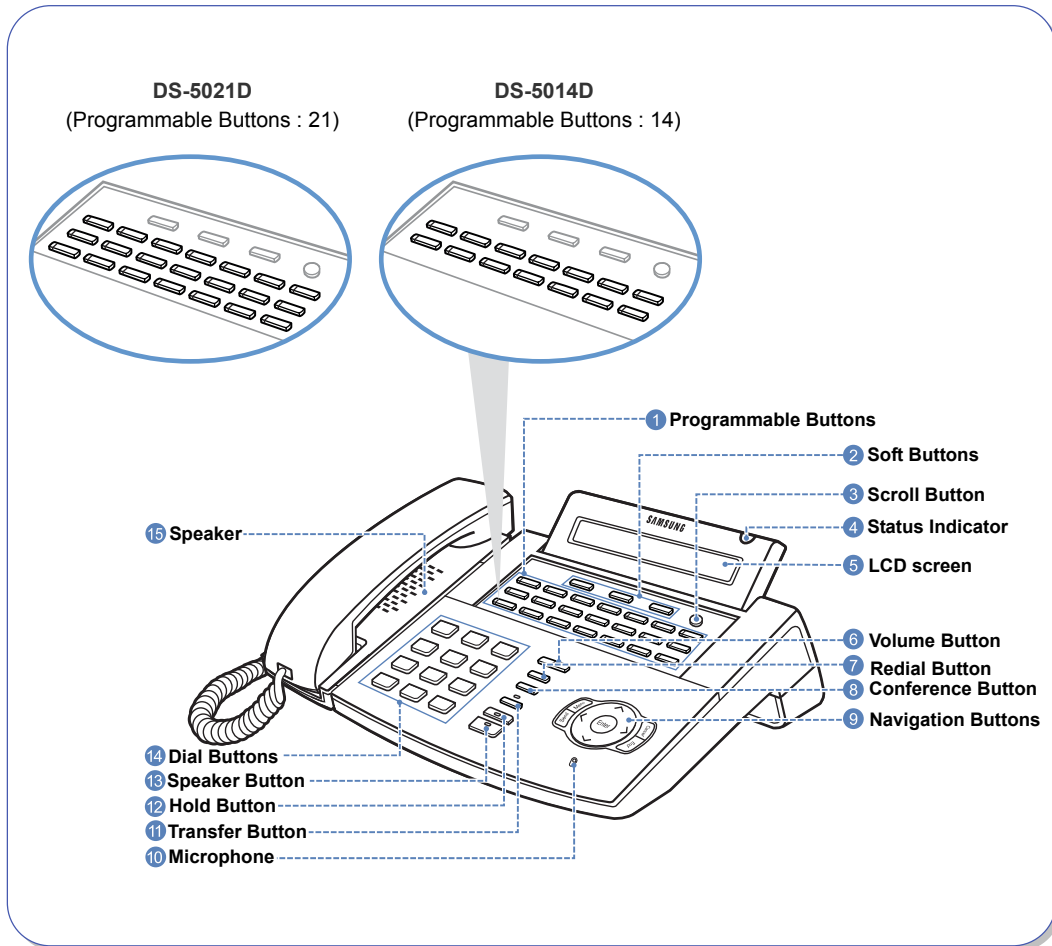

Part Name and Features

1 Programmable Buttons

The DS-5021D digital phone has 21 programmable buttons and the DS-5014D digital phone has 14 programmable buttons. The programmable buttons allow you to activate desired functions or telephone numbers with a single button press.

Among the programmable buttons, the functions of 3 buttons are pre-set as follows.

- Message Button

When someone has left you a message this button's LED blinks.

- Call1, Call2 Buttons

While the hold or conference functions are in use, the corresponding button's LED blinks. Up to 6 call buttons can be set. By default 2 call buttons are set.

2 Soft Buttons

If the Scroll button is pressed, the function menus appear on the LCD screen. The Soft buttons can be used to select the desired menu from the function menus displayed.

3 Scroll Button

This button is used to activate the function menu on the LCD screen when in the idle condition. If this Scroll button is pressed, 3 menus [CALL, OTHER, ANS] will be displayed on the LCD screen.

4 Status Indicator

The indicator shows the status of the phone with 3 colours : red, green and yellow.

5 LCD screen

The LCD screen shows the processing status and progress of a call, in addition to the various function menus depending on the status of the phone.

6 Volume Button

The volume button is used to control the volume of the phone handset, speakerphone, ringer, background music and voice announcements.

7 Redial Button

Pressing this button dials the last phone number that you just called or allows you to view up to 10 previously dialled calls.

8 Conference Button

This button allows you to set up a conference call for up to 5 people, including you.

9 Navigation Buttons

This button allows you to access the phone's menu functions. The menu functions include the recent outgoing call log, incoming call log, system directory functions, transferring incoming calls, inquiry of speed dial numbers, and alarm function.

10 Microphone

On the right side of speaker button, a microphone is located under a small hole in the plastic casing. You use the microphone in speakerphone mode to speak to your caller.

11 Transfer Button

This button is used in the following cases:

- When transferring your current call to other extension, extension group or externally.
- During a screened transfer pressing the transfer button allows you to toggle between the original caller and station user you wish to transfer the caller to.
- To enter station based programming options.

12 Hold Button

The hold button is used to place an existing call on hold and return to the call at a later time without hanging-up.

13 Speaker Button

This is used when you wish to use the phone's speakerphone.

14 Dial Buttons

The dial buttons are used to input digits, and is made up of 10 digits [0]-[9] and [*], [#] buttons. Also, if a dial button is pressed for a longer duration, the corresponding personal speed dial number can be dialed.

15 Speaker

You can hear call status tones and announcements over the phone's speaker.

Bottom View of the DS-5021D / 5014D

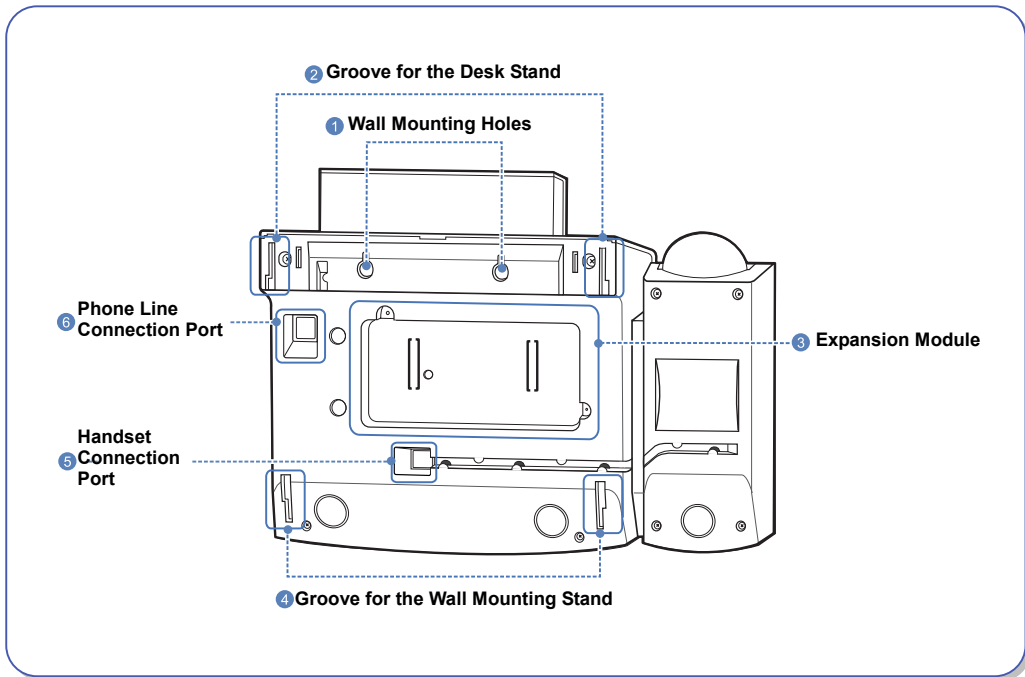

Part Name and Features

① Wall Mounting Holes

When used as a wall mounting phone, these 2 holes are used to secure the phone on screws that are installed in the wall.

② Groove for the Desk Stand

When used as the desk phone, assemble the phone stand into these grooves.

③ Expansion Module

Plug the KDB module into this module and secure with the two screws provided.

④ Groove for the Wall Mounting Stand

When used as a wall-mounting phone, assemble the phone stand into these grooves.

⑤ Handset Connection Port

Plug the handset cord into this port marked with the  symbol.

⑥ Phone Line Connection Port

Connect the phone line cord.

Additional Module

As the additional modules that can be connected to the DS-5021D/5014D phones and provide various functions, there are KDB-D/KDB-S/KDB-F for the modules types. The acoustic optic modulator(AOM) can be also connected to the DS-5021D/5014D phone.

Module Type	Functions
KDB-D	Can connect the digital extension device.(Supplying the DLI Port)
KDB-S	Can connect a regular phone with a wireless phone.(Supplying the SLI port)
KDB-F	Changes the speakerphone mode to the full duplex and provides an enhanced function.
AOM	Including 64 programmable buttons, this module can be connected to the DS-5021D/5014D phone.

KDB

The DS-5021D/5014D phone has 3 types of KDB module, such as KDB-D/KDB-S/KDB-F, and one of these can be installed in the phone. If the KDB module is installed, the phone function can be enhanced, and depending on the module types, the number of local ports can be increased. The shape of KDB module is shown below.

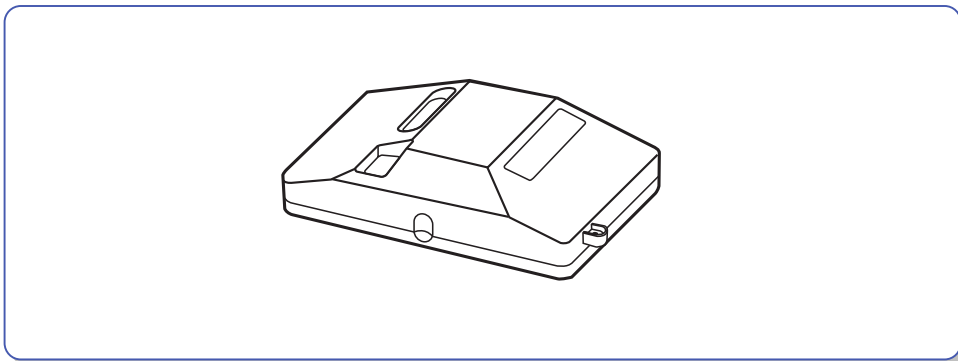

KDB-D

If the phone is added to the DLI(Digital Line Interface) port that supports 2B+D, the KDB-D module can be installed. The KDB-D module provides the DLI port, so it connects the digital extension devices, such as a digital phone or 64-button module.

KDB-S

If the phone is added to the DLI(Digital Line Interface) port that supports 2B+D, the KDB-S module can be installed. The KDB-S provides the SLI(Single Line Interface) port that can connect a wireless phone with a regular phone.

KDB-F

The standard mode of speakerphone in DS-5021D/5014D phone is 'Half Duplex'. The half duplex means that it can communicate in both directions but only one way at a time. The KDB-F enhances the speakerphone mode to the full duplex, so it can provide better communication. Connecting up to 3 external microphones to the KDB-F module, a conference can use this in a very convenient way. To use this function, the phone shall have the pre-programmed EXTMIC button.

AOM

There is AOM(Add On Module) other than the KDB modules, as for the additional modules that provide various functions by connecting to the DS-5021D/5014D phone.

The AOM is a button expansion box that is composed of programmable buttons only. The DS-5021D/5014D phone can connect AOM of 64 buttons. If the AOM module is installed, that means more programmable buttons are added. Then more functions can be registered for convenient use.

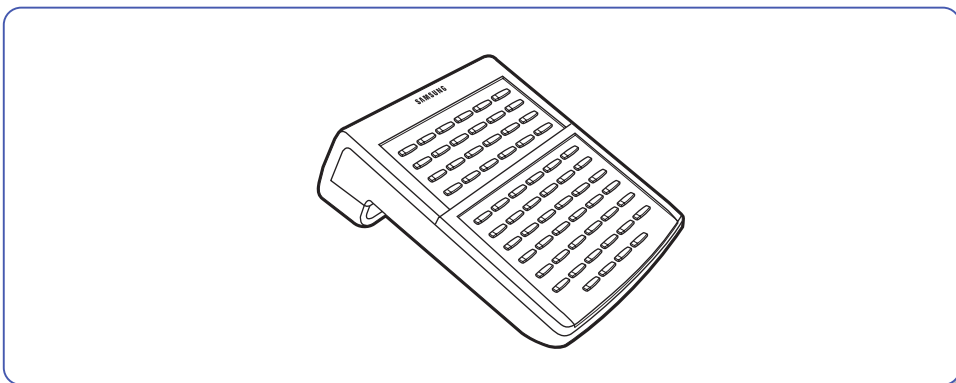

Connecting Lines to the Phone

- 1 Connect the handset cord to the port marked with the handset symbol.
- 2 Connect the line cord to the phone line connection port.

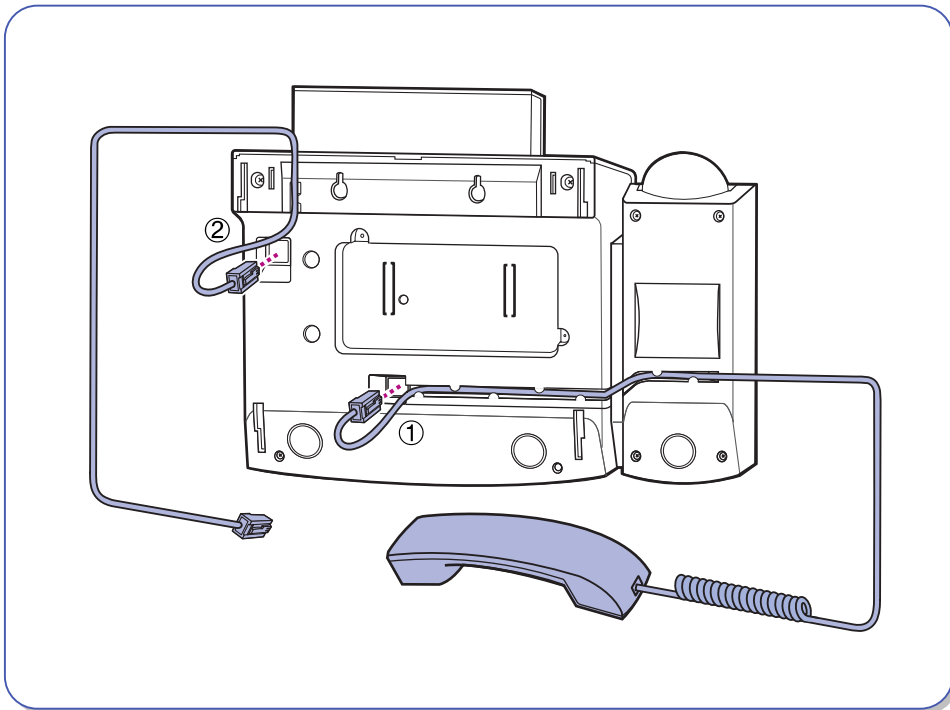

Using the Desktop Stand

If the phone needs to be used in a desktop environment, insert the desktop stand into the two side holes, which are located at the rear of the phone, and push it in the upward direction, as shown in the figure below.

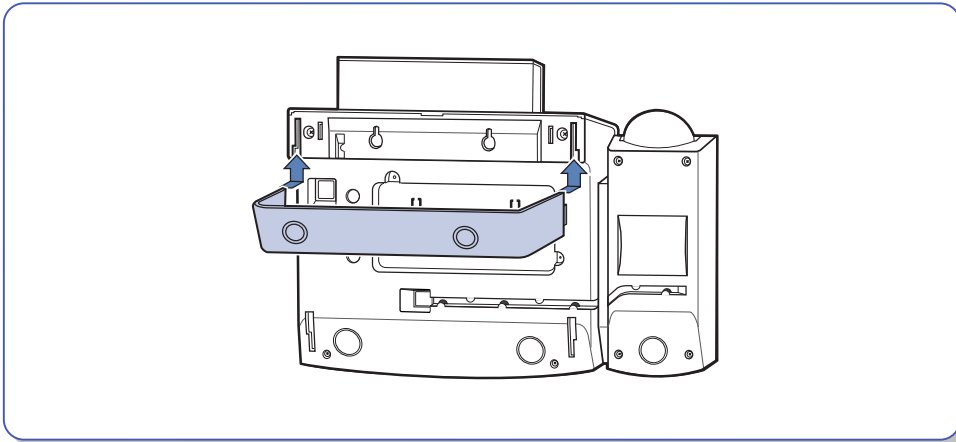

When used as the wall mounting Phone

Assemble the stand into the left/right slots that are located in the lower section of the base. Place the two holes for wall mounting on screws that are installed on the wall.

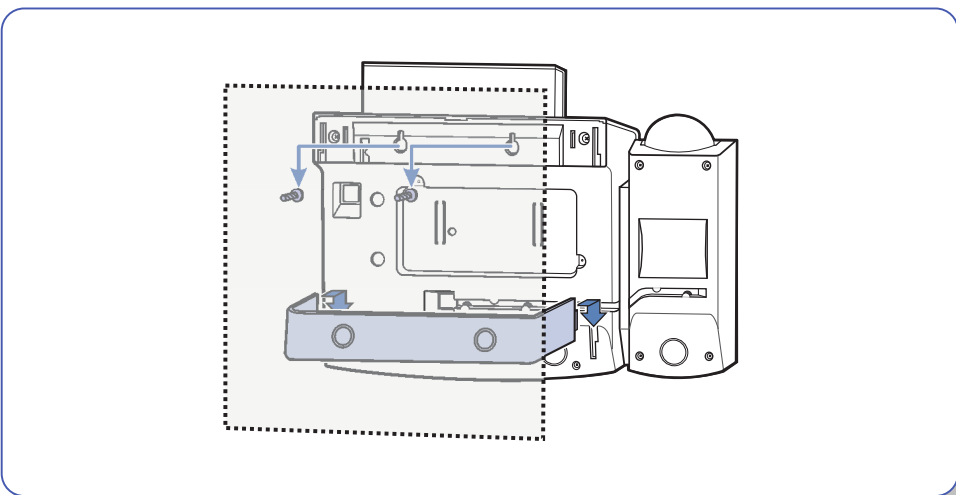

When used as a wall mounted phone, the location of the handset hook should be changed so that the handset can be secured. Take out the handset hook, flip it over and then insert the hook back into the hook holder as shown.

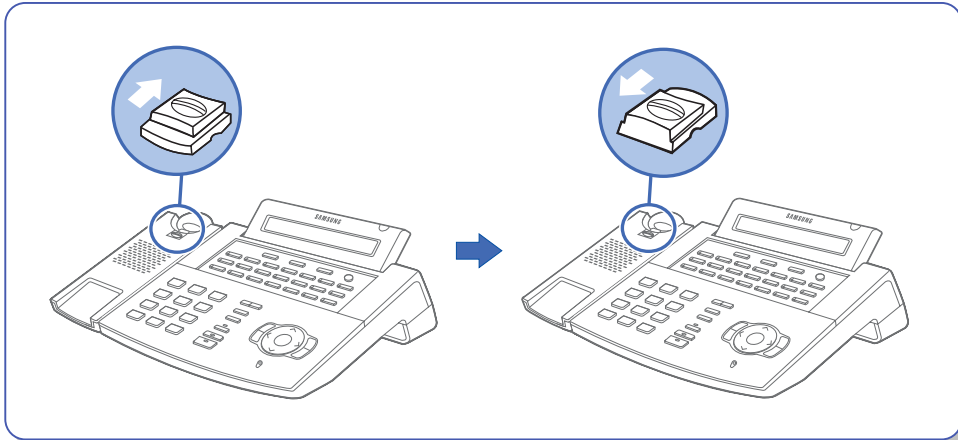

Adding a KDB Module

- 1 In the center of the bottom panel, there is an expansion module that can install KDB. Two connectors are covered with the plastic cover, which shall be removed in order to install the KDB module.

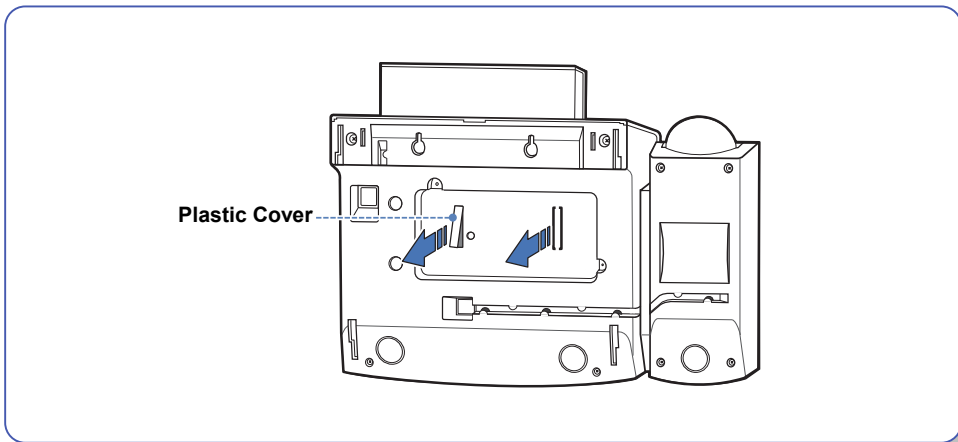

- 2 After removing the cover, plug in the KDB module and secure with the two screws provided.

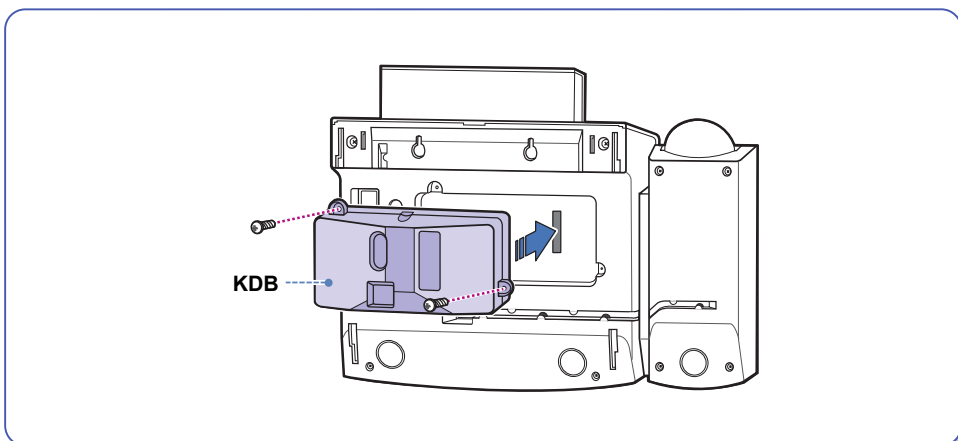

Adding an AOM

- 1** Connect the DLI(Digital Line Interface) cable on the main system to the DLI port at the bottom of AOM. At this time, the AOM extension pair shall be assigned at the telephone system in order to use AOM.
- 2** Prepare the following AOM connectors and 4 screws that are provided with AOM itself.

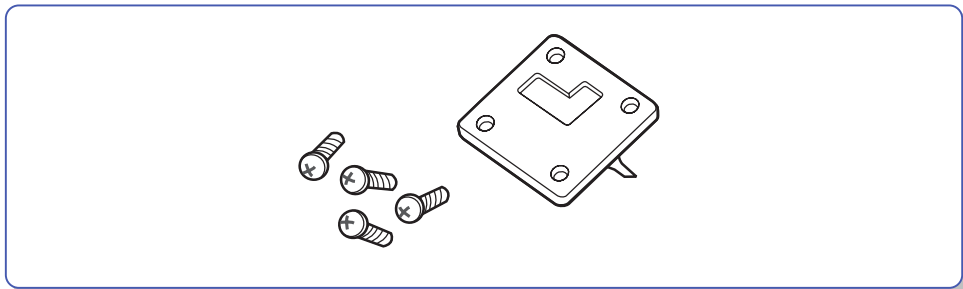

- 3** Connect AOM to the phone by using the AOM connector. Place the AOM connector over two screw holes in the right side of AOM and the other two screw holes at the side of DS-5021D/5014D line cord port. Then tighten those screws.

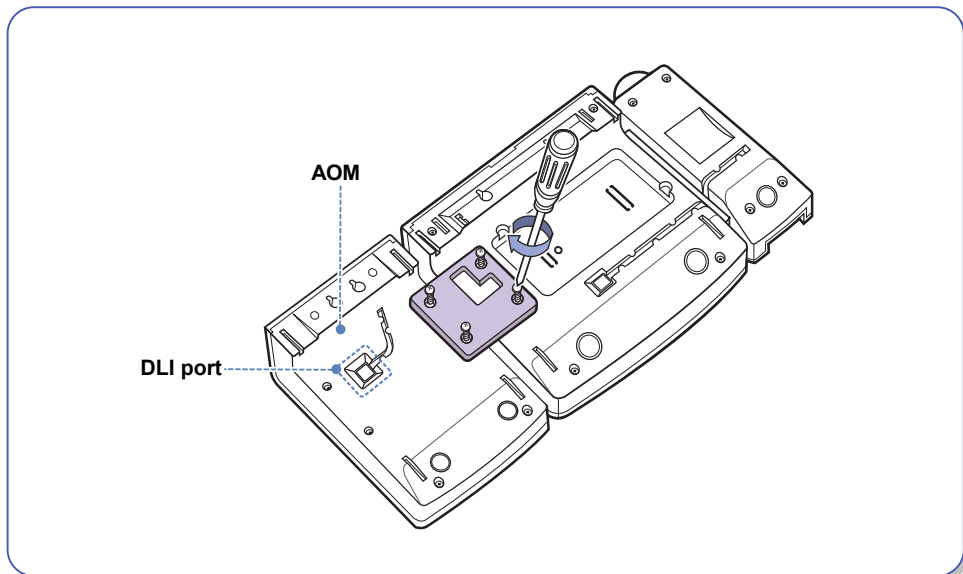

THINGS YOU SHOULD KNOW

About Stations and Trunk Lines	24
Selecting System Functions.....	25
Entering Characters	30
Configuring My Phone	32
Volume Adjustment	37
Types of Signal Tone.....	39
Telephone Status Indicator.....	40
Button LED	40



About Stations and Trunk Lines

A station is a digital or IP phone or standard telephone connected to the OfficeServ system

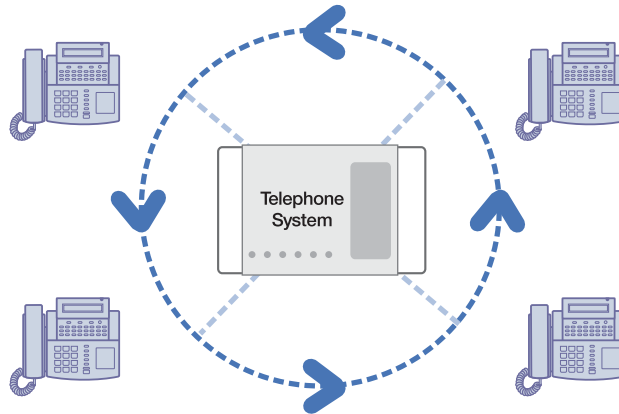

A trunk line is directly connected to your phone company's telephone network. It allows you to make telephone calls to parties outside your office (for example, your home) or to receive incoming calls from external parties.

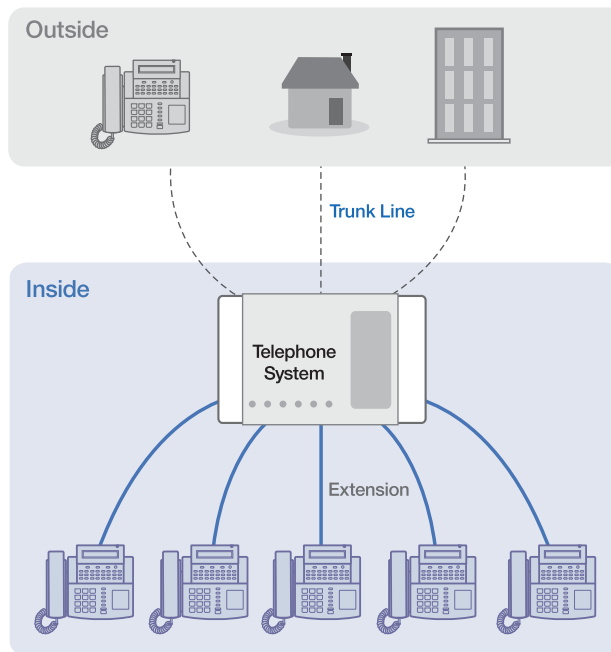

Selecting System Functions

To use the functions of the OfficeServ system you can: press the programmable button that is registered with the required function, select the function by using the Scroll button and 3 Soft buttons that are underneath the LCD screen or dial the function code.

For example, if the callback function is required, find the programmable button with this function first. If this button doesn't exist, then press the Soft button corresponding to the location of [CBK] on the LCD screen.

Using the Scroll / Soft Button

The Scroll button is used to display the function menu on the LCD screen. If the Scroll button is pressed, the LCD screen will show three menus such as [CALL], [OTHER], and [ANS] in a row. If the Scroll button is pressed again, another menu appears.

Three Soft buttons are located underneath the LCD screen.

Among three Soft buttons, the one on the left is called the left Soft button, and the one in the middle is called the middle Soft button, and finally the one on the right is called the right Soft button.

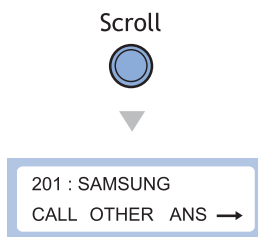
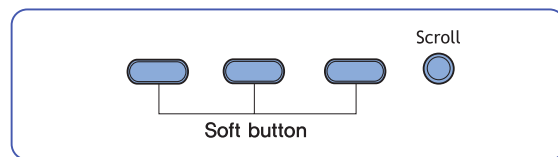

- 1 Press the Scroll button once when the phone is in the idle state and the LCD screen will show the screen.

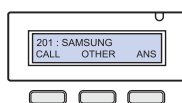

- 2 First, select one of the main menus ; [CALL], [OTHER], or [ANS]. To select the [CALL] menu, press the left Soft button, to select the [OTHER] menu, press the middle Soft button, and finally to select the [ANS] menu, press the right Soft button.

Scroll



- 3** Keep pressing the Scroll button until the desired function shows up. If there is a → symbol displayed, it means that additional menus are available.

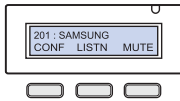

- 4** If the desired function appears on the LCD screen, select it by using the Soft button associated with the desired function.

Using the Function Code

Many of the OfficeServ system functions can be invoked by dialling function codes. Please refer to the table below for the default function codes (these may be changed in your system.) Refer to your System Administrator.

Dial Button	Function	Dial Button	Function
0	Trunk access group number	55+0	Page internal zone 0
10+xxx	Answer parked calls	55+1	Page internal zone 1
11	Set calls on hold or clear on hold	55+2	Page internal zone 2
12+xxx	Answer call on hold at another station	55+3	Page internal zone 3
13	Release door lock	55+4	Page internal zone 4
16+xxx	Assign speed-dial number	55+5	Page external zone 1
17	Dial stored number	55+6	Page external zone 2
19	Redial	55+7	Page external zone 3
2xx	Station number	55+8	Page external zone 4
3xx	Station number	55 9	Page all external zones
400	Cancel DND	55+*	Page all zones
401	Set DND	56	Answer transfer page
41	Set Message No Ring	57	Clear alarm sensor
42+xxx	Cancel message	58	Clear DISA Alarm

Dial Button	Function	Dial Button	Function
43	Set/Return message	59	Change to my station level
44	Reserve connection to a busy station/trunk line	600	Cancel all call forwarding
45	Busy station Camp-on	601+xxx	Set Forward All Calls
46	Conference	602+xxx	Set Forward Busy
47	Enter account code	603+xxx	Set Forward No Ans
48	Set station message	604+xxx	Set Forward Busy/No Ans
49	Flash	66	Group call pickup
500~529	Station group	67	Night ring answer
53+grp+0	Exclude group	681	Voice Dialler
53+grp+1	Include group	682	Record Voice Dialler
54+zone	Transfer page	7xx	Trunk line
55+0	Page all internal zones	8x	Trunk group number
606 + xxx	Set Forward Follow me	9	Attendant Console group
65	Direct call pickup		

**NOTE**

If the table above does not have the desired function code or the function code does not match with the desired function, the system's numbering plan may have been changed ; please consult with your System Administrator.

Assigning the Programmable Button Extenders

By adding an extender to some buttons, you can use the phone more conveniently. For example, if the extender 4 is added to the [PAGE] button, when this button is pressed, it will allow a page announcement to be made to stations in page zone 4. Refer to the following table to select the extenders that can be assigned for each programmable button.

Button	Description	Extenders
BOSS	Director/Secretary	1-4
DP	Direct Call Pick-up	Station or station group number
DS	Direct Station	Required station numbers
FWRD	Call Forwarding	0=FWD Cancel, 1=FWD All, 2=FWD Busy, 3=FWD No Answer, 4 FWD Busy/No Answer, 5=FWD DND and-6=Follow Me
GPIK	Group Call Pick-up	01-20
GCONF	Conference group	1-5
IG	Group In/Out	Required station group 5XX(X)
MMPG	Meet Me Page	0-9, *
PARK	Park Orbits	0-9
PMSG	Programmed Message	01-20
PAGE	Paging	0-9, *
SG	Station Group Selection	5XX(X)
SPD	Speed Dial	Personal 00-49, or System 500-999
DIR	Directory Name Dialling	PERS(1), SYS(2) or STN(3)
VT	Voice Mail Transfer	Voice Mail Group(5XX)

Transfer



1 Press the **[Transfer]** button.



2 Press **[1]►[0]►[7]**.



3 Select the programmable button that requires an extender by using the **[▼Volume▲]** button to, scroll through programmable buttons and then press the right Soft button, or press the programmable button to add an extender.

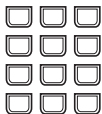

4 When the cursor comes to the input area on the LCD panel, dial the required extender.

Transfer



5 Save the extender by pressing the right or left Soft button. Press the **[Transfer]** button to finish programming.

Entering Characters

Using the dial buttons of this phone, you can easily enter/edit letters, numbers and special characters.

Special Button Used

To enter letters of the alphabet the following special button is used.

- 'A' Button : Switch to capital/small letters when entering characters.

The 'A' button of the **DS-5021D/5014D** phone is located on the first button of the bottom row of the programmable buttons below the LCD screen.

DS-5021D

An example for the DS-5021D is shown.

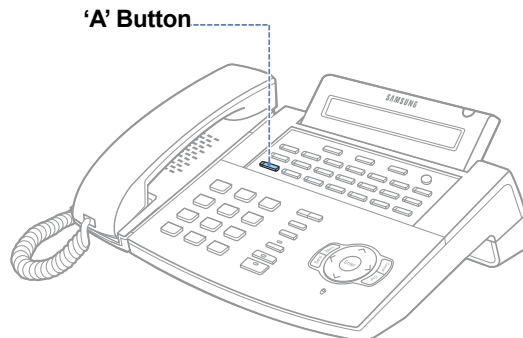

DS-5014D

An example for the DS-5014D is shown.

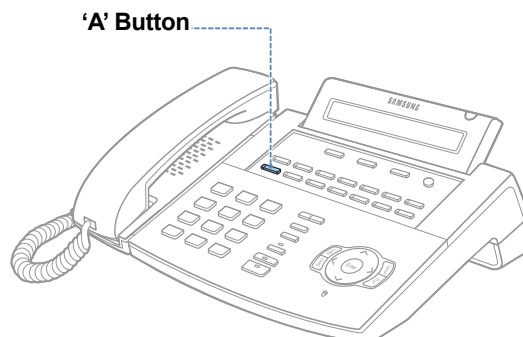

Entering Characters

Press the [▼Volume▲] button to move the cursor and insert or modify the desired letter. Press the [▼Volume▲] button and move the cursor one space to the right to use the same dial button letters as the previous letter used. Procedures for entering characters are described below.

Procedures for entering characters are described below.

Enter the characters according to the table below. Press the 'A' button to switch between capital and lower case letters.

Dial button \ Dial frequency	1	2	3	4	5
0	<	>	.)	0
1	Space	?	,	!	1
2	A	B	C	@	2
3	D	E	F	#	3
4	G	H	I	\$	4
5	J	K	L	%	5
6	M	N	O	^	6
7	P	Q	R	S	7
8	T	U	V	*	8
9	W	X	Y	Z	9
*	:	=	[]	*
#	# ? - [) 	Space . <] _	& , > @ + "	! % / ^ { →	: \$ = (} ,

Press the [#] button to enter special characters. Special characters are displayed in the following order.

▶ space ▶ & ▶ ! ▶ : ▶ ? ▶ . ▶ , ▶ % ▶ \$ ▶ - ▶ < ▶ > ▶ / ▶ =
▶ [▶] ▶ @ ▶ ^ ▶ (▶) ▶ _ ▶ + ▶ { ▶ } ▶ | ▶ ; ▶ " ▶ → ▶ ' ▶

Configuring My Phone

Allows you to set the feature preferences for your phone.

To Change the Passcode

The pre-assigned station passcode is 1234. You can change the station passcode if needed.



1 Press the **[Transfer]** button.



2 Press **[1]►[0]►[1]**.

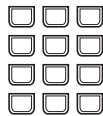

3 Enter the previous passcode.



4 Enter the new passcode. The passcode must be a 4-digit number.



5 Re-enter the new passcode for confirmation. If the passcode is entered correctly, a beep will be heard twice. If four beeps are heard, it means that the new passcode entry was unsuccessful. Please re-enter the new passcode.



6 Save the new passcode by pressing the **[Transfer]** button.

Setting the Answer Mode

Intercom calls can be answered with one of three answer modes. A different answering mode can be selected for

- [0] ANS MODE : the answer mode when answering intercom calls.
- [1] EXEC ANS : the answer mode when answering calls using the executive/secretary hot line.
You must be a designated Boss or Secretary for this option to be available.



1 Press the **[Transfer]** button.



2 Press **[1]►[0]►[3]**.



3 Select the call type(ANS MODE or EXEC ANS) using the **[▼Volume▲]** button. Move the cursor by pressing the right Soft button.



4 Press **[0]**(Ring mode), **[1]**(Auto Answer mode), or **[2]**(Voice Announce).



5 Press the **[Transfer]** button and save the selected entry.



NOTE

If your phone is programmed for the Voice Announce answering function, and Call Forwarding No Answer is set, you must press the [Speaker] button or [Send] button to answer before the no answer timer expires. Otherwise, the call will be forwarded.

Using the Headset / Handset (Headset Operation)

The DS-5021D/5014D Digital phone user can switch between handset mode and headset mode. In headset mode, you can answer or end a call by pressing the [Send] button or [End] button.



1 Press the [Transfer] button.



2 Press [1] ► [1] ► [0].

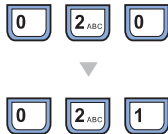

3 To use the handset, press [0] ► [2] ► [0], and to use the headset, press [0] ► [2] ► [1].



4 Save the selected entry by pressing the [Transfer] button.

Enabling / Disabling the Key Confirmation Tone

You can enable or disable a short confirmation tone whenever a dial button is pressed.



1 Press the **[Transfer]** button.



2 Press **[1] ► [1] ► [0]**.

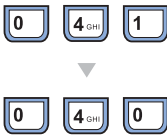

3 To use the key confirmation tone, press **[0] ► [4] ► [1]**, and to disable that the tone, press **[0] ► [4] ► [0]**.



4 Save the selected entry by pressing the **[Transfer]** button.

Pulse to Tone Changeover



When making an outside call on a dial pulse(mechanical) line, press the [#] button. All digits dialed after the [#] button will be sent as tones(electronic method).

Hot Keypad

The hot keypad allows you to make a call or activate the other functions of the OfficeServ system by pressing the dial buttons or function keys directly, without picking up the handset or pressing the [Speaker] button.

If the hot keypad function is turned off, you must pick up the handset or press the [Speaker] button first.



1 Press the [Transfer] button.



2 Press [1]►[1]►[0].

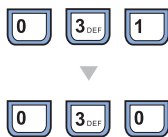

3 To enable hot keypad, press [0]►[3]►[1], and to disable, press [0]►[3]►[0].



4 Save the selected entry by pressing the [Transfer] button.

Volume Adjustment

The [▼Volume▲] button is used for adjusting the volume of the handset, speaker, and ringer.

Adjusting Handset Volume

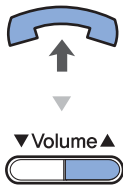

- 1 During a call using the **handset**, press the [Volume▲] button to increase the handset volume.



- 2 Press the [▼Volume] button to decrease the handset volume.

Adjusting Speaker Volume

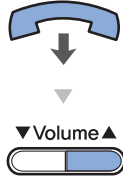

- 1 During a call using the **[Speaker]** button, press the **[Volume▲]** button to increase the speaker volume.



- 2 Press the **[▼Volume]** button to decrease the speaker volume.

Adjusting Ring Volume



- 1 To increase the ring volume, press the **[Volume▲]** button while the phone is ringing.



- 2 To decrease the ring volume, press the **[▼Volume]** button while the phone is ringing.

Types of Signal Tone

The types of signal tone used in this telephone system are described in the following table.

SignalTone Name	Usages	Signal Interval
al tone	A steady tone that indicates you can begin dialling.	Trunk, Line Continuous Station 1s ON/0.25s OFF
Ring back tone	Indicates the station you dialled is ringing.	ON OFF 1s ON/ 2s OFF
Busy tone	Indicates the station you dialled is busy.	0.5s ON/ 0.5s OFF
Transfer tone	Indicates your call is being held and you can dial another station.	0.1s ON/ 0.1s OFF
Confirmation tone	Very short beeps that indicate you have correctly set or cancelled a system feature.	0.05s ON/ 0.05s OFF

Telephone Status Indicator

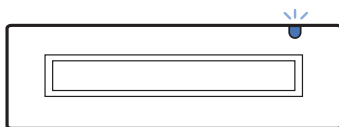

The status indicator turns on or off according to the telephone status.



Functions	Status of LCD Indicators
Busy/Off-hook	Steady red.
Extension Ring	Flashing red.
Trunk Ring	Flashing green.
Recalling	Flashing yellow.
Message waiting	Flashing red.
Calling Denied	Fast flashing red within 1 second interval.

Button LED

The **[Transfer]** button, **[Hold]** button, and **[Speaker]** button have a LED that turns on or off according to the phone status.

Button LED	LED Status	Function
Transfer 	Steady red	When 'Forward All Calls' is set or a Follow me has been set.
Hold 	Flashing red	When the phone is locked for any outgoing Trunk call.
	Steady red	When the entire phone is locked.
Speaker 	Steady red	When the phone is used as a speakerphone.

BASIC FEATURES

Before Making / Answering a Call	42
Intercom Calls	43
Outside Calls	49
Intercom / Outside Calls.....	58



Before Making / Answering a Call

This section provides you with information on how to make or answer a call by using the handset or speakerphone.

Calling Methods

Using a handset



This function allows you to lift the handset and make a call.

Using a speakerphone



This function allows you to make a call through the speakerphone without lifting the handset.

Call Answering Methods

Using a handset

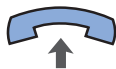

This function allows you to lift the handset and answer a call.

Using a speakerphone



This function allows you to answer a call through the speakerphone without lifting the handset.

Intercom Calls

This function is used when you want to make a call to other stations.

Assigning the Names to Your Extension

You can assign a name of up to 11 letters to your extension.

This allows other extension users with display stations to call you using the directory dial feature and to see your name when you call them.



1 Press the **[Transfer]** button.



2 Press **[1] ► [0] ► [4]**.

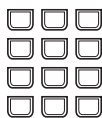

3 Enter the name.
Refer to the 'Things You Should Know' in this guide for entering characters.



4 Save the name by pressing the **[Transfer]** button.

Calling an Extension Number



- 1** Pick up the handset and check for dial tone.

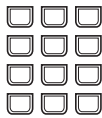

- 2** Dial the extension number or station group number.
Wait until the other party answers the call.
If a short signal tone(not a ringing tone) is heard,
the receiving extension has set up the Voice Announce
or Automatic Answer function.



- 3** Replace the handset or press the **[End]** button
to finish the call.

**NOTE**

If you have a [DSS] button assigned to an extension number or station group, press this button instead of dialing the corresponding station number.

Answering an Intercom Call



- 1 When the phone rings, pick up the handset or press the **[Speaker]** button or **[Send]** button.



- 2 To finish the call replace the handset or press either the **[Speaker]** or **[End]** button.

Voice Page Announce Mode (Intercom Calls Only)

When another station calls you, a short signal tone will be heard followed by the caller's announcement.



- 1 To answer the call, pick up the handset or press the **[Send]** button.



- 2 To end the call, replace the handset or press either the **[End]** or **[Speaker]** button.

Automatic Answer Mode (Intercom Calls Only)

When another station calls you, a short signal tone will be heard and then the phone automatically answers the call.



- 1** The microphone and speaker are turned on and you can communicate hands-free.



- 2** For a private conversation, lift the handset.



- 3** To end the call, replace the handset or press either the [End] or **[Speaker]** button.

Busy Station Callback

When the called station is busy, you can set a busy station callback. When the busy station becomes free, your phone will ring. If you pick up the phone, the other station will begin to ring.



- 1 When you hear a busy signal, press the **[CBK]** button or press [4] ► [4]. Or, press the Soft button corresponding to [CBK] on the LCD panel.



- 2 When you hear the confirmation signal, replace the handset.

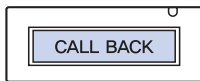

- 3 When the reserved station becomes free, your phone rings. The '**CALL BACK**' message will appear on the LCD screen.

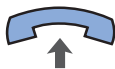

- 4 Lift the **handset** or press the [Speaker] or [Send] button to call the current idle station.



- 5 To end the call, replace the handset or press either the **[Speaker]** or [End] button.



NOTE

If you do not answer the Callback within 30 seconds, the callback will be cancelled. If a callback is set up, the [CBK] button's LED, if programmed, will light.

Busy Station Camp-On

When you call another station and receive a busy signal, you can give the called station off-hook ring tone and wait for a little while.



- 1 Press the **[CAMP]** button or press [4] ► [5].
Or, press the Soft button corresponding to the [CAMP] on the LCD screen.



- 2 The called station will receive off-hook ring tone repeated every few seconds and an available [Call] button will flash to indicate your call is waiting.

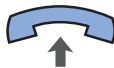

- 3 Wait for the called party to answer.
The called station must release its first call or place it on hold before answering your camp-on.

Calling Your System Operator



Press **[9]** to call your system operator or operator group. If you want to call a specific operator, dial that person's extension number.

Outside Calls

This function is used when you want to make an external call using any available trunk line.

Calling Outside numbers

You can use a handset or speakerphone when calling an external number.

To make an external call with a handset, follow the procedures below.

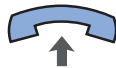

1 Pick up the handset.

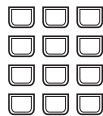

2 Press the trunk or trunk group button or dial the trunk group access code(e.g., 0).

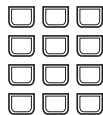

3 Dial the telephone number you want to call.



4 Finish your call by replacing the handset or pressing the [End] button.



NOTE

If the hot keypad feature is used, you can make an external call without picking up a handset by dialling the trunk access code.

To make an external call with a speakerphone, follow the procedures below.

Speaker



1 Press the **[Speaker]** button.

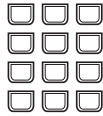

2 Press the trunk line or dial the trunk access code.

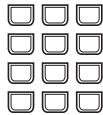

3 Dial the telephone number.

Speaker



4 Finish the call, by pressing the **[Speaker]** button.



NOTE

If the LCR(Least Cost Routing) feature is enabled on the OfficeServ system, press the [LCR] button or dial the LCR access code.

Authorization Code and Account Code

Authorization Code

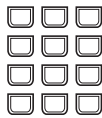

If your OfficeServ system is programmed to require you to enter an authorization code before making a call, press [*] plus a valid code before selecting a trunk line.

Account Code



If your OfficeServ system is programmed to require you to enter an account code before making a call, press the **[ACCT]** button or press [4]►[7] plus a valid code, press the [ACCT] button again and then select a trunk line.

**NOTE**

Ask your System Administrator for more information on authorization codes and account codes.

Answering an Outside Call



If you lift up the handset when the phone is ringing, you are automatically connected to the ringing call. Or, press the **[Send]** button to automatically answer on the speakerphone.

**NOTE**

If a call is flashing at your phone but not ringing, you must press the flashing button to answer.

Universal Answer



External calls may be programmed to ring through an external speaker. In this case, press [6]►[7] or the press **[UA]** button to answer the call.

New Call



Press the **[NEW]** button to disconnect your existing call, wait for dial tone and then make a new call on the same line. If this **[NEW]** button does not appear on your phone, press the Soft button corresponding to **[NEW]** on the LCD screen.

Busy Line Queuing With Callback

If there are no available trunk lines, you will hear busy tone when you try to make an external call, you can set a callback. When a line becomes free, your phone will ring. You can reserve up to 5 callbacks for extension or trunk calls.



- 1 If you receive a busy tone when trying to access a trunk line, press the **[CBK]** button or press [4]►[4].
Or, press the Soft button corresponding to **[CBK]** on the LCD screen.



- 2 When confirmation tone is heard, put down the handset.



- When the line becomes free, the system will call you back.



- Lift the handset or press the **[Send]** button to respond to the Callback. Wait for dial tone and dial the telephone number or speed dial number again.

**NOTE**

A callback will be cancelled if not answered within 30 seconds. If you have set a callback, your [CBK] button's LED, if programmed, will light.

Cancelling Callback

A maximum of 5 callbacks can be set for extensions or external calls lines at the same time. To cancel a callback, follow the procedure below.



- Press the **[CBK]** button or press [4] ► [4]. You will hear confirmation tone.



- Press the **[Hold]** button. This will cancel the oldest callback that you have set.

Redial

To redial the last telephone number you dialed, press the [Send] button for approximately 2 seconds or press [1][9].

Pressing the [Redial] key will give you the option to review up to 10 of your previously dialed external numbers.



1 Press the **[Redial]** button.



2 Use the direction buttons or the **[▼Volume▲]** button to select the required number to redial and press the Soft button corresponding to [Dial].



3 To review details about the previous call prior to dialling it, press the Soft button corresponding to **[NND]**.



4 Press the **[Redial]** button twice to automatically redial the last number you dialed.

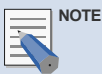

- If the hot keypad feature is turned off, you have to lift up the handset first or press the [Speaker] button before you begin using the redial feature.
- Redial does not apply to intercom calls.

Save Number with Redial

[SAVE]



- 1** To save the number you just dialled for later use, press the **[SAVE]** button before hanging up.

[SNR]



- 2** This saved number can be redialled at any time by pressing the **[SNR]** button or dialling [1]►[7]. The same external trunk line will be selected for you.



NOTE

- The saved telephone number will be saved in memory until you save another number.
- Saved Number Redial does not apply to intercom calls.

Automatic Redial / Retry

When you make an outside call and receive a busy signal, the OfficeServ system can automatically redial the number for you. It will automatically redial at a pre-programmed interval for up to 99 attempts.



- 1 When you hear a busy signal, press the **[RETRY]** button or press the Soft button corresponding to **[RETRY]** on the LCD screen.

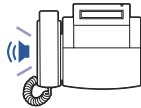

- 2 The system will reserve the line and automatically redial the same number for you. You will hear the call progress tones through the speaker. At this time, the microphone is muted.



- 3 When the called party answers, you must pick up the handset or press the **[Speaker]** or **[Send]** button before you begin speaking.
You must answer within 10 seconds.



NOTE

- If you make another call, auto-redial is cancelled.
- To cancel a retry, lift and replace the handset.

Call Park

You can park an outside call in one of 10 'parking orbits'.



- 1 Press the **[PARK]** button.
Or, press the Soft button corresponding to [PARK] on the LCD screen.

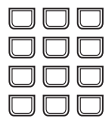

- 2 Dial the orbit number required, **[0]-[9]** ; the [PARK] button will flash.
Or, press a dedicated [PARK] button ; the [PARK] button will also flash.
To have the call 'parked' picked up by another station, notify the station user of the parking orbit number.



- 3 To pick up the parked call, press the **[PARK]** button followed by the required orbit number or press the flashing [PARK] button.

Intercom / Outside Calls

Holding a Call

You can temporarily suspend a conversation without ending the call by placing the call on hold. Or, when another call is received, you can put your first call on hold and answer the new call. You can simply press the button on hold again to resume the conversation. The types of hold available are system hold(general hold), automatic hold, exclusive hold, and consultation hold.

System Hold



- 1 While you are engaged in a conversation, press the **[Hold]** button.



- 2 The call on hold will flash green on your phone and this line will flash red on other stations.

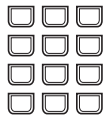

- 3 To return to the held call. Press the line button. The green LED will stop flashing.



- 4 Resume your conversation with the other party.



NOTE

While you are on a call, pressing a trunk line button or flashing Call button will automatically put your first call on hold and connect you to the new call. Refer below.

Automatic Hold

With Automatic Hold set, when you are answering an outside call, pressing the trunk line or flashing Call button will automatically put your outside call on hold and connect you to the next call. You can set Automatic hold on your phone by following the procedure below.



1 Press the **[Transfer]** button.



2 Press **[1]►[1]►[0]**.



3 To use this function, press **[0]►[0]►[1]**, and if this function is not required, press **[0]►[0]►[0]**.



4 Press the **[Transfer]** button to save the selected item.



NOTE

Intercom calls will be placed on hold by pressing the [Hold] or [Transfer] button. If you press another trunk line button or flashing Call button while you are on an intercom call, the intercom will be disconnected.

Exclusive Hold

To place an outside call on hold exclusively so that other users cannot get it.



1 Press the **[Hold]** button twice.



2 The call will flash green on your phone and this line will show a steady red light on other stations.



3 To retrieve the call on hold, press the flashing green line button or press the **[Hold]** button.

**NOTE**

Intercom calls will always be placed on exclusive hold.

Consultation Hold

When you are talking to an external caller and it is necessary to consult with another extension.



- 1 Press the **[Transfer]** button ; you will hear transfer dial tone. Your outside call is placed on Transfer hold.

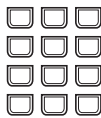

- 2 Dial the extension number.



- 3 Consult with the internal party.



- 4 Press the **[Transfer]** button to return to the outside party or to hang up to transfer the call.



NOTE

Repeatedly pressing the [Transfer] button will toggle between the outside party and internal extension.

Hold Recall



- 1 If you leave a call on hold longer than the system hold timer allows, it will recall your station. At this time, the call button on hold will have a slow flashing amber light. If you do not answer this recall within a pre-programmed period of time, it may go to the system operator depending upon your OfficeServ system programming.

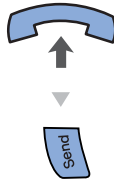

- 2 When your phone rings, lift the handset or press the **[Send]** button to answer the recall.

Retrieving Calls Held at Another Station



- 1 When a line is on system hold, the line will have a flashing red light. To retrieve the call on hold, press the line button with the red flashing light.



- 2 When a line is on hold and it does not appear on your phone, press **[1]▶[2]** plus the line number or the extension number of the station that placed the call on hold.

Call Pickup

This section explains how to pickup a call that is ringing at another station.

Station Call Pickup

If a call rings on another station and you know the station number, you can answer the call on your phone.

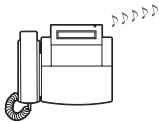

1 A call is ringing on another station.



2 Pick up the handset and listen for the dial tone.



3 Press **[6]** ► **[5]**.

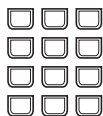

4 Dial the station number that is ringing.

Group Call Pickup

Each station can be assigned to a call pickup group. Refer to your System Administrator for details on your pick up group.



- 1 When a call is ringing on another station assigned to your pick up group.

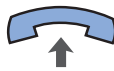

- 2 Pick up the handset and check for dial tone.



- 3 Press **[6]** ► **[6]**.

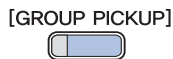

- 4 Or press the flashing **[GROUP PICKUP]** button, or press **[GROUP PICKUP]** button followed by the related group number.



NOTE

- A group number(extender) can be assigned to the **[GROUP PICKUP]** button.
- Station Call Pickup and Group Call Pickup may not enable you to answer the recalls at stations depending on the OfficeServ system programming. Refer to your Samsung Authorised Reseller for further details.

Dialling by Directory Name

Each extension number or speed dial number can have a relevant directory name.

You can select the extension number or speed dial number from the list of directory names by scrolling down in alphabetical order. This online directory allows you to make any extension call or to find a speed dial number within just a few seconds.



- 1 Press the **[DIR]** button, or press the Soft button related to [DIR] in the CALL menu.

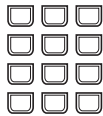

- 2 Select the directory you wish to use, PERS(Personal, Speed Dial Number), SYS(System Speed Dial Number) or STN(Station Name).

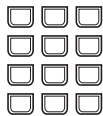

- 3 Press the dial button that matches the first letter of name that you wish to find.

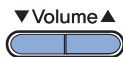

- 4 Find the required name by using the **[▼Volume▲]** button.



- 5 Press the Soft button corresponding to **[DIAL]** on the LCD screen to make the call to the selected number.



NOTE

To directly move to one of the directories, an extender can be added to [DIR] button. [1] for the Personal Speed Dial list, [2] for the System Speed Dial list and [3] for the Station list.

Transferring Calls

You can transfer your call to another extension or return to the outside party.



- 1 While on a call, press the **[Transfer]** button.
Your call is automatically put on transfer hold.

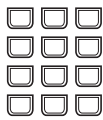

- 2 Dial an extension or group number.
Or, press the [DSS] button or station group button.
Your call will be automatically put on transfer hold.



- 3 For blind transfer, hang up when you hear ringing. Or, wait for the called party to answer and advise him/her of the call.
Then hang up.

Reconnection with the Outside Party



If the transfer is refused and the called station hangs up, you will be reconnected to the outside line.
Or, you can press the **[Transfer]** button to return to the outside party.

Call Retransferring



If you wish to send the call to another extension without waiting for the first station to hang up, simply press another **[DSS]** button.

Or, press the CALL button or trunk line button to return to the outside party and begin the transfer process again.



NOTE

- When you are transferring a call to a station programmed for Voice Announce or Auto Answer, the transferred call will always ring.
- After the internal party answers, you may alternate back and forth between the parties by pressing the [Transfer] button.
- You cannot transfer an Intercom call by pressing the [DSS] button for the station required. You must press the [Transfer] button first and then press the [DSS] button or dial the destination extension number.

Transfer With Camp-On



When you are transferring a call to another station and you receive a busy signal, you may camp the call on to this station. So, when this station becomes free, it can be connected to the transferred call.

Simply hang up when you hear a busy signal.

Then, the called party will be alerted by a call waiting tone.

Transfer To Voice Mail

This feature is used to send a call directly to a voice mailbox. Your phone must have a correctly programmed [VT] button to accomplish this.



- 1 Press the **[VT]** button while you are on a call.
Or, press the Soft button corresponding to [VT] on the LCD screen.

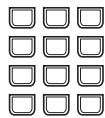

- 2 Dial the mailbox number.



- 3 Hang up when dialling is completed.

Call Waiting

If an outside call or another station has camped-on to you, your phone will ring and the waiting call's LED will flash green.



- 1 Press the flashing button to answer the waiting call.
If your phone has the Automatic Hold feature set, your current call will go on hold automatically.



- 2 If Automatic Hold is not set, press the **[Hold]** button and then press the button with the flashing LED.
Or, finish the first call and hang up ; the waiting call will ring your phone.



- 3 Lift the handset or press the **[Send]** button to answer.

Speed-Dial

You may assign any frequently used numbers to a personal speed dial number list for your station. These personal speed dial numbers are in addition to the system Speed dial numbers available. Speed dial numbers can be allocated to buttons which allow you to press the one touch speed dial button to call the number.

Explanation of Special Feature Buttons

When programming speed dial numbers, the special feature buttons are used and they are designated as A, B, C, D, E, and F buttons. Each special feature button is explained in the following table.

A, B, C, D, E, and F buttons of the DS-5021D/5014D digital phone are the first 6 buttons in the last row of the programmable buttons located below the LCD screen.

For example, the DS-5021D digital phone is shown below.

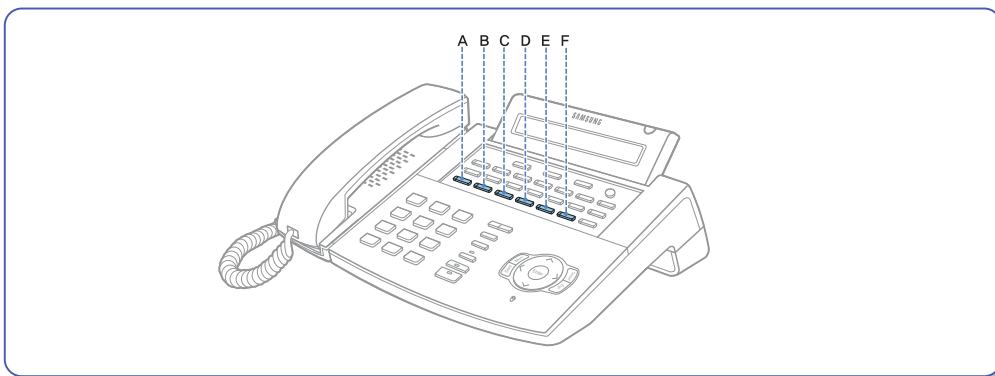

Button	Features
A Button	Not used.
B Button	To insert a FLASH(time loop break).
C Button	To insert a PAUSE.
D Button	To convert from the pulse dialling(mechnical method) to the tone dialing (Electronic method).
E Button	Used to hide the numbers from showing up on the LCD screen.
F Button	Used to input a speed dial name.
Hold Button	To clear a speed dial number.

Programming the Speed Dial Numbers

Your station can be assigned up to fifty numbers, 00~49. Ask your System Administrator for the number of speed dial numbers that have been assigned to your station.

To program the personal dial numbers,



- 1 Press the **[Transfer]** button and press [1]►[0]►[5], without lifting the handset.

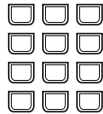

- 2 Select a free speed dial number location(00-49).

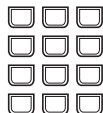

- 3 Dial either a specific trunk line number or the trunk access code.

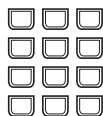

- 4 Dial the telephone number to be saved(maximum of 24 digits), including the #, *, FLASH, PAUSE, etc. Press the special key [F] to enter a name for the Speed dial number then press the special key [F] to return to the speed dial entry menu again.



- 5 Press the [Transfer] button to save the number. Or press the right Soft button and repeat steps 2 to 5.

Dialling Speed Dial Numbers

You can dial a speed dial number stored in the list of system speed dial numbers between 500-999 or the list of your personal number between 00-49 using the following procedure.

[Memory]



- 1 Press the **[Memory]** button or press [1]▶[6], without lifting the handset.

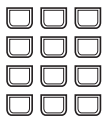

- 2 Dial the speed dial location number that is programmed with the telephone number you wish to call.



- 3 The telephone number is automatically dialled for you.

Alternatively, to dial one of your first 10 personal speed dial numbers.

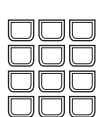

- 1 Without lifting the handset, press a dial button 0-9 for approximately 2 Seconds.



- 2 The telephone number programmed in the corresponding personal speed dial location(00-09) will be dialled automatically.

Assigning a Name to the Speed Dial Button.

A name of 11 characters can be assigned for each speed dial button.

This name is used to dial the telephone number using the directory feature.



1 Press the **[Transfer]** button.



2 Press **[1] ► [0] ► [6]**.

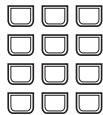

3 Press the speed dial number location to be assigned with a name(00-49).

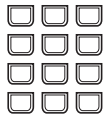

4 Enter a name. Refer to the **'Things You Should Know'** in this manual for how to enter a letter.



5 Press the **[Transfer]** button to save the speed dial name or the right Soft button to .enter further names by repeating steps 3 to 5.

Programming One-touch Speed Dial Buttons

You can assign a frequently used number from the speed dial numbers to one of the programmable keys on the phone for one touch speed dial use.



- 1 Without lifting up the handset, press the **[Transfer]** button.



- 2 Press **[1] ► [0] ► [7]**.



- 3 Locate a vacant **[SPD]** button using the **[Volume▲]** button and press the right Soft button.

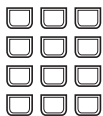

- 4 Dial the speed dial number location(00-49 or 500-999) to be assigned for this button.



- 5 Press the **[Transfer]** button to save the selected number.



- 6 If the one touch speed dial button is pressed, a call is made to this saved speed dial number automatically.

Using Chain Dialling

After a speed dial number is pressed, additional numbers can be dialled manually or you can chain together speed dial numbers.



After the first speed dial number, press the **[Memory]** button or press [1] ► [6] and then dial other speed dial number location.

Or after the speed dial number is pressed, dial the additional numbers manually.

Conference Calls

You can make a conference call of up to 5 parties including yourself. The OfficeServ system also allows each station to pre assign up to 5 conference groups so you can set up a conference call by pressing a single [Group Conference] programmable button. Refer to your System Administrator to confirm that this option is available to you.



- 1 Press the **[Conference]** button while engaged in a conversation. You will hear conference tone.

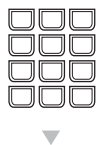

- 2 Make another call, either intercom or outside. Press the **[Conference]** button and you will hear conference Tone.



- 3 Make another call to add additional parties or press the **[Conference]** button to join all parties into the conference.



Then, Repeat the last step, until all other parties required are connected.

Conference



Conference



- 4** To drop a person from your conference call, press the **[Conference]** button and dial the extension or trunk number that is to be dropped.

Press the [Conference] button again to re-establish the conference.



NOTE

When attempting to add another person to the conference and you are not able to reach the desired person, simply press the [Conference] button again.

Programming Conference Groups.

Transfer



- 1** Press the **[Transfer]** button.



- 2** Press **[1]►[1]►[8]**.

▼Volume▲

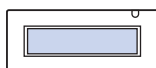

- 3** Select the required Conference Group number by using the **[▼Volume▲]** button and press the right Soft button.



- 4** Select 'Name' and press the right Soft button to enter the Conference Group name. Refer to the '**Things You Should Know**' in this guide for entering characters. Press the right Soft button to save the name.

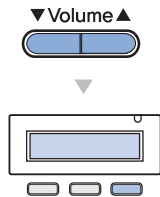

- 5** Using the [**▼Volume▲**] button to select [MBR1~4] and press the right Soft button.

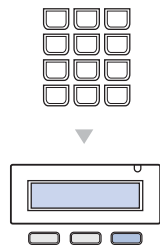

- 6** Dial the extension number or outside telephone number remembering to dial the trunk access code first and press the right Soft button. Repeat steps 6 and 7 to add conference group members.



- 7** Save the settings by pressing the [**Transfer**] button. To make a group conference call press the [GCONF] button followed by the group number and the conference will be setup automatically. If an extender has been added to the [GCONF] button(1~5) just press the [GCONF] programmable button.

CONVENIENT FEATURES

Do Not Disturb	78
Call Forwarding	80
Paging and Messaging	88
Alarm Features	101
Use with the Door Phone	105
Executive / Secretary Hot Line	107
Group Listening	108
Account Code	109
Locking Your Phone	110
Off-Hook Voice Announcement	111
In Group / Out Of Group	113
Mute	114
Background Music	115
Timer	116
Ring Preference	118



Do Not Disturb

When Do Not Disturb is registered, you can block incoming calls to your phone yet still use the phone for outgoing calls.

Setting Do Not Disturb



- 1 Press the **[DND]** button or press [4]▶[0]▶[1] while on-hook, or select [DND] from the LCD screen using the Scroll button and [Other] Soft button.

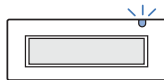

- 2 The status indicator and/or [DND] button LED flashes to inform you that the Do Not Disturb mode is set.



NOTE

- When the phone is set in the Do Not Disturb mode, the phone status indicator(LED above the LCD) flashes indicating that the Do Not Disturb mode is set.
- If a Forward DND destination has been set, all incoming calls will be forwarded to that destination when DND is enabled.

Cancelling Do Not Disturb

The procedure for cancelling the Do Not Disturb mode is described below.

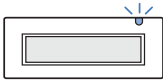

1 Check if the status indicator is flashing.



2 Press the **[DND]** button or press [4]▶[0]▶[0].

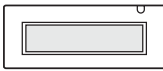

3 The status indicator goes off.

One Time DND



If you do not wish to be disturbed while you are on a call, press the [DND] button and set the station to Do Not Disturb. When you complete the call, the Do Not Disturb mode is automatically cancelled and new calls will be received.

A **[DND]** button is needed to use this feature.

Call Forwarding

This section explains various call forwarding features available on your OfficeServ system.

Call Forward Option

You can verify or change the Call Forward settings and the number specified for forwarding from the LCD screen of your phone. Enabling Call Forwarding can also be achieved using the dial buttons or the Forward Set Menu.



1 Press the **[Transfer]** button.



2 Press **[1]►[0]►[2]**.



3 Select the Call Forward option by dialling from [0] to [5], or by using the **[▼Volume▲]** button.



4 Press the right Soft button to move the cursor.

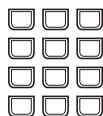

5 Dial the station, station group, or external number remembering to insert the trunk access code prior to the external number.



6 Press the right Soft button to move the cursor.



7 Press [1] to enable call forwarding to the destination, or press the [**▼Volume▲**] button and select between [YES] or [NO].



8 Press the [**Transfer**] button to save and exit.

Forwarding Calls

You can forward calls to another station, station group, or an external number.

Programming procedures for various types of forwarding calls are described in detail next. If your phone has the FWD ALL, FWD BUSY, and FWD NO ANSWER FWD BUSY/NO ANSWER buttons, you can forward calls by pressing one of these buttons.

In this case, a red LED is lit on the button indicating which call forward option is enabled.

In order to cancel all forward call options, lift the handset and press **[6] ► [0] ► [0]**.

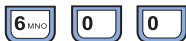

Forwarding All Calls

You can forward all your calls to another internal, station group or external number.



1 Press **[6]►[0]►[1]**.

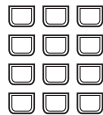

2 Dial the station number, group number, or external number. Remember to insert the trunk access code prior to entering the external number.

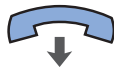

3 Hang up after the confirmation tone is received.



NOTE

- The station receiving a forwarded call can transfer the call back to the forwarding station. This feature is very useful when you are expecting an important call and do not want to be disturbed.
- If you set your phone to Forward All Calls, and you do not have a [FORWARD ALL] button the [Transfer] button will light. This indicates that your phone is set to Forward All Calls.

Forward Busy

When you are busy on a call, incoming calls can be forwarded to another station, station group or an external number.



1 Press **[6] ► [0] ► [2]**.

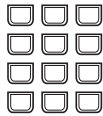

2 Dial the station number, group number, or external number. Remember to insert the trunk access code prior to entering the external number.



3 Hang up after the confirmation tone is received.

Forward No Answer

Calls can be forwarded when you are not available to answer the call.



1 Press **[6]►[0]►[3]**.

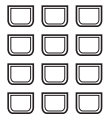

2 Dial the station number, group number, or external number. Remember to insert the trunk access code prior to entering the external number.



3 Hang up after the confirmation tone is received.

Forward Busy / No Answer

When the Forward Busy(FWD BUSY) and Forward No Answer(FWD NOANS) destinations are both set, you may enable both these options simultaneously.

When you are busy, calls will be transferred to the number specified in Forward Busy destination. If you do not answer, the calls will be forwarded to the Forward No Answer destination.



1 Press [6]►[0]►[4].



2 Hang up after the confirmation tone is received.

Forward When DND is Set

You can set a forward destination for those times you need to set Do Not Disturb.



1 Press [6]►[0]►[5].

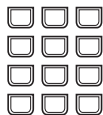

2 Dial the station number, group number, or external number. Remember to insert the trunk access code prior to entering the external number.



3 Hang up after the confirmation tone is received. When you enable DND on your phone, all calls will be forwarded to the destination set above.

Forward Follow Me

All incoming calls to your phone can be forwarded to the station you are currently using. In addition, you can arrange for calls to another station to be forwarded to your phone (Remote Forwarding).

To forward all calls to your phone to the station you are currently using:



- 1 Press **[6]** ► **[0]** ► **[6]** at the station you are using. 'enter the station to follow from' is displayed.

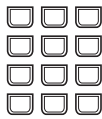

- 2 Dial the station number of your phone.



- 3 Hang up after the confirmation tone is received.

To forward calls from a specific station to your phone (Remote Forwarding):



- 1** Press **[6] ► [0] ► [6]**.
'enter the station to follow from' is displayed.

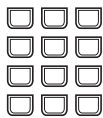

- 2** Dial the station number.



- 3** Hang up after the confirmation tone is received.

Paging and Messaging

This section explains how to use the OfficeServ paging and messaging functions.

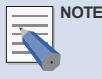

- NOTE**
- You must use the phone handset when paging.
 - If you are a frequent user of paging you can have a dedicated page zone button as one of your programmable buttons, making it unnecessary to press the [PAGE] button followed by the zone number.

Internal Page

You can make a page announcement through the station speakers.

There are 5 internal zones 0-4.



- 1** Pick up the handset and check for dial tone.



- 2** Press the **[PAGE]** button or press [5]►[5], or select [PAGE] from the LCD screen by using the Scroll button and Soft buttons.



- 3** Select a zone number from **[0]**, **[1]**, **[2]**, **[3]**, and **[4]**.



- 4** Start your announcement after receiving confirmation tone.



- 5** Hang up after paging.

External Page

You can page externally through optional external speakers.
There are 4 external zones 5–8 and [9] for all external zones.



- 1 Pick up the handset and check for dial tone.



- 2 Press the **[PAGE]** button or [5] ► [5], or select [PAGE] from the LCD screen by using the Scroll button and Soft buttons.



- 3 Select a zone number from **[5]**, **[6]**, **[7]**, and **[8]**, or page all external zones by dialling **[9]**.



- 4 Start your announcement after receiving confirmation tone.



- 5 Hang up after paging.

All Page

You can also page all external zones and internal page zone 0 simultaneously.



- 1 Pick up the handset and check the dial tone.



- 2 Press the **[PAGE]** button or [5] ► [5], or select [PAGE] from the LCD screen by using the Scroll button and Soft buttons.



- 3 Press the [*] or [ALL PAGE] button.



- 4 Start your announcement after receiving confirmation tone.



- 5 Hang up after paging.

Meet Me Page : MMPG



1 Pick up the handset and check for dial tone.



2 Press the **[MMPG]** button or [5] ► [4], or select [MMPG] from the LCD screen using the Scroll button and Soft buttons.

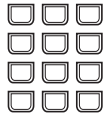

3 Dial the required zone number.



4 After receiving the confirmation tone instruct the other party to press **[5] ► [6]**.



5 Press the [WAIT] or **[Transfer]** button.



6 Hold the handset until the other party enters the page answer code([5] ► [6]).



7 The call is automatically connected when the other party enters the page answer code.

Call Park and Page

You can transfer an external call to another person by parking the call and notifying the other person of the call via paging. This function is useful in a factory or in a large office when the called person is away from their workstation.



- 1** Press the **[PAGE]** button while connected to the call and the call is automatically on hold. You can also select [PAGE] from the LCD screen using the Soft button.

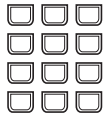

- 2** Dial the appropriate page zone number to notify that the call is parked and to inform the required party of your station number or the calling trunk number.



- 3** Hang up.

Retrieving the parked call



- 1 Press the **[PARK]** button or press [1]►[0], and enter the announced number.

You can also enter the announced number after selecting [PARK] from the LCD screen.



- 2 You will be connected to the Parked call.



NOTE

If the parked call is not retrieved within the pre-programmed time, the parked call will recall to your phone, an amber light will blink slowly on the Call or trunk button LED. You cannot park and page intercom calls.

Rejoining a Page

With this option, you can listen to the latter part of a page announcement after finishing a call.



1 Press the **[Transfer]** button or [1]▶[1]▶[0].



2 Press **[0]▶[5]▶[1]** to enable this option, and **[0]▶[5]▶[0]** to disable it.



3 Press the **[Transfer]** button to save the setting.

Setting a Message Indication

You can leave a message indication when there is no answer or if the station required is busy.



1 Press the **[Message]** button or press [4]►[3].



2 Hang up after hearing confirmation tone.



3 The **[Message]** button of the receiving station will flash. phones without the [Message] button will receive special dial tone as a message indicator. The status indicator will also flash red.



NOTE

You can leave up to 5 messages on a station.

Cancelling Messages

You can cancel messages you have left on other stations or messages left at your station.



- 1** Press **[4] ► [2]** and enter the station number where you left your message.



- 2** To cancel all numbers left at your station, press **[4] ► [2]** and enter your station number.
The LED on your **[Message]** button and the status indicator will go out.

Returning Messages



- 1 Press the [Message] button to review the stations that have left messages and press the Soft button associated with [Dial] on the LCD screen to call the station. Or, press **[4]►[3]** and the first station that left its number will be rung automatically.



- 2 The LED on your **[Message]** button and status indicator will remain flashing until the station responds. Repeat the above steps to respond to all station messages received.



- 3 The LED on your **[Message]** button and status indicator will go off when all messages are returned or cancelled.



NOTE

- You can view the numbers left and return messages in any order through the LCD screen.
- If a message was left at your phone by a station in Auto Answer mode, you must cancel the message manually, after returning the message.

Viewing Message Indication

You can view all messages before returning them.



- 1 Press the flashing **[Message]** button.
The first station that left its number is displayed on the screen.



- 2 Press the **[▼Volume▲]** button to scroll through the messages.

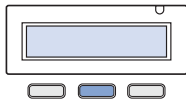

- 3 Use the Soft buttons to return or cancel the message or to move to the next message.



- 4 Press the **[Speaker]** or **[End]** button after responding to the message left.

Programmed Messages

You can leave a programmed message on your station when you are away from your phone. The caller will see the message on their LCD when they call you and know that you are not available. 15 system wide messages are available(01–15) and 5 personal messages(16–20)



1 Press **[4]►[8]** and select the desired message code from the programmed message list.



2 Press **[4]►[8]** then **[0]►[0]** to cancel the message.

Programmed Message List

When you are away for a certain period of time, you can leave a message of absence on stations by selecting a message accordingly.

The caller will see the message and know that you are away.

Message code	Message
01	GIVE ME THE CALL
02	TAKE A MESSAGE
03	ASK THEM TO HOLD
04	SEND TO MY VM
05	TRSF TO MY SECY
06	LEAVE A MESSAGE
07	PAGE ME
08	OUT OF TOWN
09	IN A MEETING
10	I WILL CALLBACK
11-15	Defined by the System Administrator.
16~20	Blank Message(You can set up)



NOTE

- Your System Administrator can edit the first 15 Programmable Messages.
- Your personal Programmed Messages using the following procedure:
 1. Press the [Transfer] button when your phone is in the idle condition.
 2. Press [1][1][5].
 3. Select the Programmed Message you wish to insert or modify(e.g. 16).
 4. Enter the characters required in accordance with the procedure below.
 5. Press the [Transfer] button to save the information and set the Programmed Message to your phone.



NOTE

Your phone may have multiple programmed message buttons, each of which has different message codes.

- Press any programmed message button. A red light comes on the button's LED indicates that the message has been set. Press the button again to clear the message.
- Press another programmed message button to clear the previous message and set the new message.

Alarm Features

Appointment Reminder / Alarm Clock

This feature serves as an alarm clock. Up to 3 alarms may be set. Each alarm can be set as a one time alarm or a daily alarm.

Three short rings will repeat three times. Lift the handset to answer the alarm. If you do not answer, the alarm will ring two more times at 5-minute intervals.



1 Press the **[Transfer]** button.



2 Press **[1]►[1]►[2]**.



3 Dial the alarm number **[1]**, **[2]** or **[3]**.



4 Enter the time at which you want the alarm to sound. Enter the time as HHMM(hours and minutes) based on a 24 hour clock.



5 Select the type of alarm between **[0]**(Not Set), **[1]**(Today) or **[2]**(Daily).



6 Press the **[Transfer]** button to save settings. Repeat the above steps to set other alarms as needed.

Alarm Cancel

Procedure for cancelling all previously registered alarms is described below.



1 Press the **[Transfer]** button.



2 Press **[1]▶[1]▶[2]**.



3 Dial the alarm number **[1]**, **[2]** or **[3]**.



4 Press the **[Hold]** button.



NOTE

You can view the alarm message on the LCD screen. Refer to the next paragraph 'Alarm Message' for details.

Alarm Message

You can make a 16-character message to be associated with an alarm.



1 Press the **[Transfer]** button.



2 Press **[1]►[1]►[6]**.



3 Dial the alarm number **[1]**, **[2]** or **[3]**.

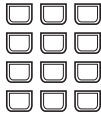

4 Enter the time at which you want the alarm to sound.
Enter the time as HHMM(hours and minutes) based on a 24-hour clock.



5 Select the type of alarm between **[0]**(Not Set), **[1]**(Today) or **[2]**(Daily).

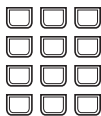

6 Enter the message using the dial buttons.
Refer to 'Things You Should Know' of this guide for procedures on entering characters.



7 Press the **[Transfer]** button and save the alarm time and message. Repeat the above steps to set other alarms and messages when needed.

Alarm Message Cancel

You can verify or change the Alarm settings from the LCD screen of your phone. Cancelling alarms can also be achieved using the dial buttons.



1 Press the **[Transfer]** button.



2 Press **[1] ► [1] ► [2]**.



3 Dial the alarm number **[1]**, **[2]** or **[3]**.



4 Press the right Soft button twice.



5 Press the **[Hold]** button to cancel.



NOTE

You can view the alarm message on the LCD screen. Refer to the above section 'Alarm Message' for details.

Use with the Door Phone

Answering The Door Phone

You can answer calls from the Door phone or open the door if an optional electric door lock is installed.

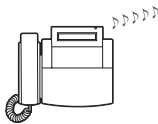

- 1 When a call from the Door phone arrives, you will receive three short bursts of ring, repeated.



- 2 Lift the handset or press the **[Send]** button to connect to the Door phone.



- 3 If an electric door lock is installed, you can open the door by dialling **[1] ► [3]**.

Calling The Door Phone / Room Monitor

You can call the Door phone and listen to what is happening outside or in another room.



1 Dial the station number of the Door phone.

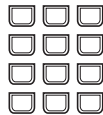

2 You can listen or have a conversation when you are connected to the Door phone.



3 If an electric door lock is installed, you can open the door by dialling **[1] ► [3]**.

Executive / Secretary Hot Line

Executive and secretary can have a hotline set up between their stations. When the Executive is in DND mode or busy on a call, all new calls will forward to the secretary station.



- 1 Either the Executive or the secretary can make a call to the other station by pressing the **[BOSS]** button or by selecting **[BOSS]** from the LCD screen using the Soft buttons.



- 2 If DND is set on the executive station or it is busy, all calls will be forwarded to the secretary station. When the secretary station receives the call, a red light flashes on the executive station.

You can transfer important calls to the **[BOSS]** station set as DND.



- 1 Press the [Transfer] button then the **[BOSS]** button, or select **[BOSS]** from the LCD screen using the Soft buttons.



- 2 Wait until the **[BOSS]** station answers to announce the call. Then, hang up. You can blind transfer the call by pressing the **[BOSS]** button and hanging up.

Group Listening

While you are in a call, you can allow others to hear the conversation through the phone speaker.



- 1 Turn on the speaker by pressing the **[LISTEN]** button, or selecting [LISTEN] from the LCD screen using the Soft button.

The microphone of the phone is not active and the other party cannot hear sounds via that source.



- 2 Press the **[LISTEN]** button again, or select [listen] from the LCD screen using the Soft button to resume a private conversation.

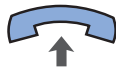

- 3 Repeat the above steps when needed.

**NOTE**

Depending on the speaker volume and acoustics of your office, it may be advisable to turn the group listening option off before hanging up. This will prevent a momentary howling.

Account Code

If specified by programming, at any stage you can print out the account code along with the call history to allow calls to be charged to specific account code. To enter an Account Code:



- 1 Press the **[ACCT]** button or select [ACCT] using the Soft button during an external trunk call.

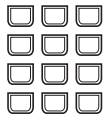

- 2 Dial the account code (Maximum 12 characters including [#]).



- 3 Press the **[ACCT]** button again or select [ACCT] using the Soft button. This does not affect your conversation with another party.



NOTE

If you make a mistake entering an account code, press the [ACCT] button twice and enter the code again. Only the last account code entered will be printed.

Locking Your Phone

You can lock your phone to prevent others from using your phone while you are away. You can unlock the phone when you return.



1 Press the **[Transfer]** button.



2 Press **[1]►[0]►[0]**.

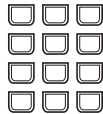

3 Dial your 4-digit station passcode.



4 Press **[2]** to lock all calls to and from your phone, **[0]** to unlock, and **[1]** to lock the phone from making outside calls only.



5 Press the **[Transfer]** button to save the settings.

Off-Hook Voice Announcement

You can make a separate announcement to a station user currently on a call.

This is not heard by the other party.

This feature is useful when you have an urgent message to deliver.

You cannot receive [OHVA] calls in DND mode. The [OHVA] feature can be used for intercom and transferred calls.

OHVA

Follow the below procedure to make an off-hook voice announcement.



- 1** Dial the extension number or the **[DSS]** button.



- 2** If you hear the busy tone, press the **[OHVA]** button or select [OHVA] from the LCD screen using the Scroll button and Soft button.

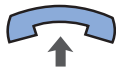

- 3** Start announcement after hearing confirmation tone.



- 4** Finish the call by replacing the handset, or pressing the **[Speaker]** or [End] button.



NOTE

When voice announcing to a nearby station, use the handset to avoid echoes.

OHVA Cancel

When receiving OHVA, you will hear the OHVA through your handset or speaker depending on which one you are using. In both cases, you can continue your call with the original party whilst listening to the OHVA. You can also talk to the announcing party, temporarily putting the other party on hold.



- 1 Press the flashing **[CALL]** button. This places the original party on hold and allows you to talk to the announcing party.



- 2 Press the related **[CALL]** button to return to the original party. This disconnects the OHVA call.

OHVA Block

You can block Off-Hook Voice Announce button on your phone. OHVA calls will not be received until you cancel the block function by pressing the **[BLOCK]** button again. If there is no **[BLOCK]** button, select **[OHBLK]** in the Other menu from the LCD screen using the **[Scroll]** button and **Soft** buttons.



OHVA Reject

You can set an OHVA **[REJECT]** button on your phone. When receiving an OHVA, press the **[REJECT]** button to disconnect the OHVA call and return to the original caller. If there is no **[REJECT]** button, select **[REJECT]** from the LCD screen using the **Soft** button.



In Group / Out Of Group

If your phone is assigned to a station group, you can remove your phone from the group or re-enter your phone to the group. When your phone is removed from the group, you will not receive calls to the station group, only calls to your station number.



- 1 Press the **[IN/OUT]** button, or select [IOG] from the Other menu on LCD screen using the [Scroll] button and Soft buttons.
Enter the station group number and select the [IN] or [OUT] soft button. If the handset is active in the group, a red light will light on the [IN/OUT] button.



- 2 Press the **[IN/OUT]** button again to remove the phone from the group.
The red light goes off. Repeat the above step when necessary.



- 3 If there is no [IN/OUT] button, press **[5] ► [3]** and the group number, and press [0] to remove your phone from the group or [1] to assign your phone to the group. Repeat the above steps when necessary.



NOTE

- You can assign a group number(Extender) designating a specific group to the [IN/OUT] button to allow you to enter and exit a group simply.
- If you are in multiple groups, you can decide which group you will receive calls from by pressing the [IN/OUT] button followed by the group number.

Mute

This feature disables the handset or phone's microphone, depending on which is in use. Thus, the other party cannot hear what you are saying.



- 1** Press the **[MUTE]** button or select [MUTE] from the LCD screen using the Soft button.
The LED of the [MUTE] button flashes.



- 2** Press the **[MUTE]** button again to cancel.
The red light on the LED of the button goes off.

Background Music

You can listen to music through the phone's speaker if a music source is provided.

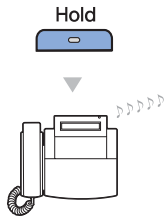

- 1** To listen to the music, press the **[Hold]** button while on-hook.

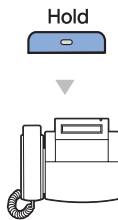

- 2** Press the **[Hold]** button again to cancel.



- 3** Use the **[▼Volume▲]** button to adjust the music Volume. This does not affect the speaker volume setting.

Timer

Call Duration Timer

You can set the timer to be activated automatically for external calls. The timer appears on the LCD screen immediately on answering an incoming call and after a period of time or when the other party answers an outgoing call.

The call duration time is displayed in minutes and seconds, and is reset when the call lasts longer than 100 minutes. Selecting [TIMER] from the LCD screen will manually reset the timer. If the automatic timer is not set, while on a call press the [TIMER] button to start the timer. Press the [TIMER] button again to stop the timer. If you press the [TIMER] button while the Auto timer is on, the call timer starts again.

Auto Timer

Your phone may have an automatic timer that starts automatically after a short period of time for forwarded and outgoing calls. This can be enabled or disabled as follows.



1 While on-hook, press the **[Transfer]** button.



2 Press **[1]►[1]►[0]**.



3 Press **[0]►[1]►[1]** to activate the Auto timer or **[0]►[1]►[0]** to deactivate.



4 Press the **[Transfer]** button to save the settings.

Timer Function

For phones, the timer can be used as a stopwatch.



- 1 Press the **[TIMER]** button, or select [TIMER] from the Other menu on the LCD screen using the [Scroll] button and Soft button when the phone is in idle mode.



- 2 Press the **[TIMER]** button again to stop the timer.

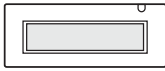

- 3 Note the elapsed time on the LCD screen.

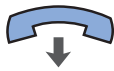

- 4 Lift and replace the handset and the time and date display on the LCD will resume.

Ring Preference

You can answer a call automatically by lifting the handset or by pressing the [Send] button. Calls are answered in the order that they arrive at your phone. If the ring preference option is off, you must answer calls by pressing the flashing button. In this case you may answer the calls without regard to the order in which they arrived.



1 Press the **[Transfer]** button.



2 Press **[1]►[1]►[0]**.



3 Press **[0]►[6]►[1]** to enable the ring preference feature.
To disable, press **[0]►[6]►[0]**.



4 Press the **[Transfer]** button to save the settings.

APPLICATION MENUS - DS-5021D / DS5014D

Navigation Buttons.....	120
Main Menu	123
Reviewing and Calling Recently Called Numbers	124
Reviewing and Calling Recently Received Numbers	125
Reviewing and Calling Speed Dial Numbers.....	126
Reviewing and Calling Numbers by Name.....	127
Setting Forward Type and Number	129
Setting Alarm Reminders	131



Navigation Buttons

The DS-5021D and DS-5014D Digital phones are equipped with navigation buttons for convenient use of the Digital phone functions. This chapter introduces the functions available using the navigation buttons and procedures for using the various applications.

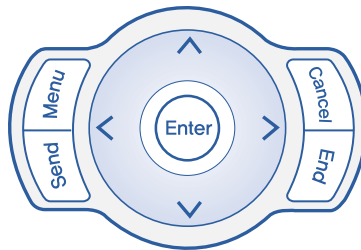

Menu Button

1. OUTGOING LOGS
2. INCOMING LOGS
3. SPD NO. SEARCH
4. DIRECTORY DIAL
5. FORWARD ASSIGN
6. ALARM ASSIGN

- 1** The main menu is displayed when the **[Menu]** button is pressed in the idle state, You can select from the presented options.

1. OUTGOING LOGS
2. INCOMING LOGS
3. SPD NO. SEARCH
4. DIRECTORY DIAL

- 2** This menu is displayed when the **[Menu]** button is pressed when dialling mode or when transferring calls. This allows you select to select and perform a function.



NOTE

Calls will be maintained even if the [Menu] button is pressed while you are talking. If you press the [End] button or the other buttons except the Navigation buttons in menu mode, you will automatically exit from the menu mode and return to the idle screen.

Send Button

If you press the **[Send]** button while the [OUTGOING LOGS], [INCOMING LOGS], [SPD NO. SEARCH], or [DIRECTORY DIAL] function is selected, the corresponding number will be dialed.

- If you press the **[Send]** button in idle mode, you enter the [OUTGOING LOGS] menu.
- If you press the **[Send]** button in dial mode, you enter the [OUTGOING LOGS] menu regardless of the numbers previously dialed.
- If you press the **[Send]** button while a call is arriving (ringing status), you will answer the call on the speakerphone.

End Button

This button is used to disconnect calls or to exit the phone menus and return to the idle display.

Cancel button

The **[Cancel]** button is used in menu mode to move to the previous level.

If the **[Cancel]** button is pressed when you first enter menu mode, the menu mode is exited.

The **[Cancel]** button is also used to delete the characters previously entered when entering numbers or characters.

Enter button

This button is used in the menu mode to select or save the item that the cursor is indicating. This button may also be used for the [NND(Name Number Display)] button when receiving calls.

- The [NND] button displays 'caller number', 'caller name', and 'received time' when you press the button, if the caller information is available.

Direction button

These buttons are used when editing menu entries, or when moving between menu items.

① [^] button is used

Used for moving to the previous menu.

② [>] button is used

In cases where the phone number is long, this button is used for displaying the rear part of the number which is not displayed on the LCD screen.

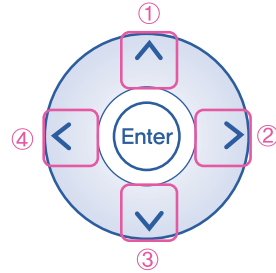

③ [v] button is used

Used for moving to the next menu.

④ [<] button is used

In cases where the phone number is long, this button is used for displaying the front part of the number which is not displayed on the LCD screen.

Main Menu

Press the **[Menu]** button to display the main menu below.

1. OUTGOING LOGS
2. INCOMING LOGS
3. SPD NO. SEARCH
4. DIRECTORY DIAL
5. FORWARD ASSIGN
6. ALARM ASSIGN

How to Select Menu

To select a menu items, you can use the navigation direction buttons, **[▼Volume▲]** button or the dial buttons.

- Use the **[^]/[V]** direction buttons or the **[▼Volume▲]** button and move to the preferred menu.
- You can select the menu directly by pressing the dial button corresponding to the menu number.
- Press the **[Enter]** button to select the menu underlined by the cursor to expose sub-menus.
- Press the **[End]** button to exit the menu and return to the idle screen.
- When buttons other than the navigation buttons are pressed, the menu mode will end.

**NOTE**

When your station is called while in menu mode, your phone will appear as busy to the calling party.

Reviewing and Calling Recently Called Numbers

Up to 50 recently called numbers can be saved. The actual number is allocated by your System Administrator. You can verify recently called numbers and redial them as required.



- 1 Press the **[Menu]** button to display the main menu screen.



- 2 Press [1] to select **[1. OUT CALL LOG]** or select and press the **[Enter]** button.



- 3 The list of recently called numbers is displayed. You can review each of the numbers in the list in turn by using the **[^]/[v]** direction buttons or the **[vVolume^]** button. Use the **[<]/[>]** direction buttons to view long numbers that do not fully appear on the screen.



- 4 Move to the number you intend to dial and press the **[Send]** button to make the call.



Reviewing and Calling Recently Received Numbers

Up to 50 recently received numbers can be saved. The actual number is allocated by the System Administrator. You can verify recently called numbers or dial them as required.



- 1 Press the **[Menu]** button to display the main menu screen.



- 2 Press [2] to select **[2. IN CALL LOG]**, or select and press the **[Enter]** button



- 3 The list of recently received numbers is displayed. You can review each of the numbers in the list in turn by using the **[^]/[v]** direction buttons or the **[▼Volume▲]** button.

Use the **[<]/[>]** direction button to view long numbers that do not fully appear on the screen.



- 4 Move to the number you intend to dial and press the **[Send]** button to make the call.



Reviewing and Calling Speed Dial Numbers

You can review or call a speed number you have personally programmed or system speed number programmed in the OfficeServ system. The System Administrator can program the system speed numbers and names.



- 1 Press the **[Menu]** button to display the main menu screen.



3. SPD NO. SEARCH

- 2 Press [3] to select **[3. SPD NO. SEARCH]**.

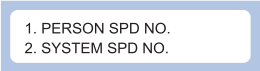

1. PERSON SPD NO.
2. SYSTEM SPD NO.

- 3 Press [1] to select **[1. PERSON SPD NO.]** or press [2] to select **[2. SYSTEM SPD NO.]**.

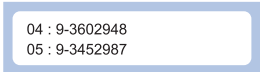

04 : 9-3602948
05 : 9-3452987

- 4 The saved speed dial number list appears.
You can review each of the numbers in the list in turn by using the direction buttons or the **[▼Volume▲]** buttons. Use the direction button to view long numbers that do not fully appear on the screen.
Move to the number you intend to dial and press the **[Send]** button to make the call.



Reviewing and Calling Numbers by Name

Using the OfficeServ system's internal directories you can review by name and then call personal or system speed dial numbers or internal station numbers.

The System Administrator can program system speed numbers and names.



- 1 Press the **[Menu]** button to display the main menu screen.



- 2 Press [4] to select **[4. DIRECTORY DIAL]** or select and press the **[Enter]** button.
The submenu below is displayed.

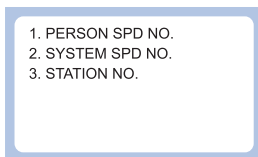

- 3 Press [1] to select **[1. PERSON SPD NO.]** or press [2] to select **[2. SYSTEM SPD NO.]** or press [3] to select **[3. STATION NO.]**, or select by using the **[▼Volume▲]** button and press the **[Enter]** button.

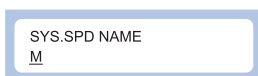

- 4 Use the dial buttons to enter the first letter of the name you intend to review, and press the **[Enter]** button.
The numbers with names starting with the entered letter are displayed. If there is no number with a name starting with the letter entered, 'It is not found' will be displayed and you may enter a new letter.



- 5** Move to the name in the list you intend to dial and press the **[Send]** button to make the call.

**NOTE**

- Refer to the 'Things You Should Know' of this guide for how to enter characters. Use the [↶]/[↷] direction buttons to move the cursor in the input screen. Press the [Cancel] button to erase the entered letter.
- Press the [Cancel] button to return to the previous menu.

Setting Forward Type and Number

When you are unavailable to answer your calls on the DS-5021D or DS-5014D Digital phone, you can set the forwarding function to have the calls answered at another station, station group or external number. Procedures for setting the forward type and numbers are described below.



1 Press the **[Menu]** button to display the main menu screen.



2 Press [5] to select **[5. FORWARD SET]** or select and press the **[Enter]** button.

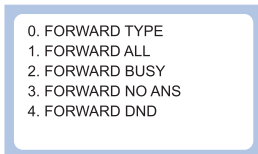

3 Select the type of forward you wish to set a destination for using the **[^]/[v]** direction buttons or the **[Volume▲]** button and press the **[Enter]** button. Or select using the dial button corresponding to the forward type.

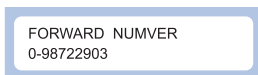

4 Enter the destination number using the dial buttons. For example, if you selected **[1. FORWARD ALL]**, enter the numbers in the LCD screen as shown. If an external number is required please insert the trunk access code(e.g. 0) in front of the number. Press the **[Enter]** button to save the number entered and to move to the upper menu. If a destination number already exists you do not need to erase it. Just enter the new destination number.



- 0. FORWARD TYPE
- 1. FORWARD ALL
- 2. FORWARD BUSY
- 3. FORWARD NO ANS
- 4. FORWARD DND

- 5** Select the forward type you wish to set.
Press [0] to select **[0. FORWARD TYPE]**.
The current forward setting is displayed.

- 0. FORWARD CANCEL
- 1. FORWARD ALL
- 2. FORWARD BUSY
- 3. FORWARD NO ANS
- 4. FORWARD BUSY/NOANS

- 6** Select the required forward type to be set by using the [^]/[v] direction button, the [▼Volume▲] button and press the [Enter] button, or by pressing the dial button corresponding to the forward type.
[0. FORWARD CANCEL] cancels your previous setting.



- 7** Press **[End]** to return to the idle screen.

Setting Alarm Reminders

This function works like an alarm clock and is useful to remind you of upcoming appointments. You can set the time and type of alarm for up to three alarms.



- 1 Press the **[Menu]** button to display the main menu screen.



- 2 Press [6] to select **[6. ALARM REMINDER]**. The submenu below is displayed.

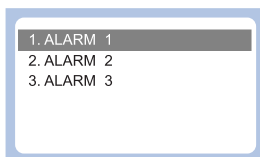

- 3 Use the **[^]/[v]** direction button or the **[▼Volume▲]** button and press the **[Enter]** button, or select the dial button corresponding to the alarm number you wish to set.



- 4 For example, if you selected **[1. ALARM 1]**, the submenu for setting the alarm type and time appears. To select **[1. ALARM TYPE]** use the **[^]/[v]** direction buttons or the **[▼Volume▲]** button and press the **[Enter]** button, or press [1].



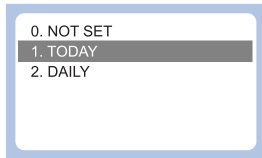

- 5** The submenu for the three alarm types is displayed as shown.

Use the [^]/[v] direction buttons, the [▼Volume▲] button, or the dial buttons to select to select the alarm type, and press the [Enter] button.

[0. NOT SET] the alarm does not ring.

[1. TODAY] the alarm rings only once at the set time when selected.

[2. DAILY] an alarm rings every day at the set time when selected.

The selected alarm type is saved and you move to the upper menu displaying the submenu shown below.



- 6** To select **[2. ALARM TIME]** use the [^]/[v] direction buttons or the [▼Volume▲] button and press the [Enter] button, or the press [2] to set the alarm time.



- 7** Use the dial buttons to enter the alarm time in 24 hour mode.

Use the [Cancel] button to erase all entered numbers. Press the **[Enter]** button to save the entered time and move to the previous menu.

ANNEX

Troubleshooting	134
Product Specifications	136



Troubleshooting

The troubleshooting for your phone is described below.

Check the troubleshooting steps before contacting your Authorised Samsung Reseller.

? **Dial tone is not heard when you lift the handset or press the [Speaker] button.**

Check if the handset and phone line are correctly connected to each port of the phone.
(Refer to 'Connecting Lines to the Phone' section of 'Preparation' in this guide.)

? **Nothing appears on the LCD screen while the phone is being used.**

Check if the phone line is correctly connected to the port of the phone.
(Refer to 'Connecting Lines to the Phone' section of 'Preparation' in this guide.)

? **The phone does not ring and volume is too low.**

Press the [▼Volume▲] button to adjust the volume.
(Refer to 'Volume Adjustment' section of the 'Things You Should Know' section in this guide.)

? **Conversation quality is reduced due to noise and echo.**

If you are using the speakerphone, lift the handset and try speaking.

? **Excessive echo is emitted during a page announcement or with Auto Answer set.**

If phones are too close to each other, sound from one speaker might echo during a page or on auto answer call.
Maintain a reasonable distance (about 1 m) between phones.

? An alarm does not ring at the programmed time.

- Check the current time is set on the phone correctly.
If the current time setting needs to be changed, contact your System Administrator.
- Check if an alarm is set.(Refer to 'Setting Alarm Reminders' in the 'Application Menus' section of this guide.)

? Caller IDs are not displayed on the LCD screen.

- Confirm with your System Administrator that the caller ID service is available from your telephone company.
- If the caller blocks the sending of their caller ID, the caller ID will not be displayed.
- If the caller makes a call from an area where the caller ID cannot be provided (e.g., international calls), the caller ID will not be displayed.
- If the caller makes a call from a public phone, the caller ID will not be displayed.
- If the caller ID received from the Telephone Company is corrupt, the caller ID will not be displayed.
- If the Telephone Company does not send a caller ID, the caller ID will not be displayed.

Product Specifications

The specifications and features of the DS-5021D/5014D Digital phone are as follows.

Items	Specification	
Model	DS-5021D	DS-5014D
Weight(kg)	1.1	
Size(mm)	266(width)×206(length)×119(height)	
Operating Temperature(°C)	0 to 45	
Operating Humidity(%)	10 to 90 non condensing	
Number of the [Programmable] buttons	21	14
Navigation Buttons	O	
Speakerphone	Full Duplex mode	
LCD	2 Line LCD 24 characters long : English	

● CLASS B (Digital device or Peripheral) ●

This equipment has been tested and found to comply with the limits for a Class B digital device, pursuant to International Standards EN55022, and EN61000, Part 15 of the FCC Rules and Australian Standard AS/NZS3548. These limits are designed to provide reasonable protection against harmful interference in a residential installation.

This equipment generates, uses and can radiate radio frequency energy and, if not installed and used in accordance with the instructions, may cause harmful interference to radio communications. However, there is no guarantee that interference will not occur in a particular installation. If this equipment does cause harmful interference to radio or television reception, which can be determined by turning the equipment off and on, the user is encouraged to try to correct the interference by one or more of the following measures:

- Reorient or relocate the receiving antenna.
- Increase the separation between the equipment and receiver.
- Connect the equipment into an outlet on a circuit different from that to which the receiver is connected.
- Consult the dealer or experienced radio TV technician for help.

Information in this document is proprietary to
SAMSUNG Electronics Co., Ltd.

No information contained here may be copied, translated,
transcribed or duplicated by any form without the prior written
consent of SAMSUNG.

Information in this document is subject to change
without notice.



Enterprise IP Solutions
 **OfficeServ** Digital Phone **User Guide**
DS-5021D / DS-5014D



Part No. : GA68-00195A(ED.01)
Printed in Korea

Free Manuals Download Website

<http://myh66.com>

<http://usermanuals.us>

<http://www.somanuals.com>

<http://www.4manuals.cc>

<http://www.manual-lib.com>

<http://www.404manual.com>

<http://www.luxmanual.com>

<http://aubethermostatmanual.com>

Golf course search by state

<http://golfingnear.com>

Email search by domain

<http://emailbydomain.com>

Auto manuals search

<http://auto.somanuals.com>

TV manuals search

<http://tv.somanuals.com>