

**SAMSUNG**

## **Electric Dryer Owner's Manual**

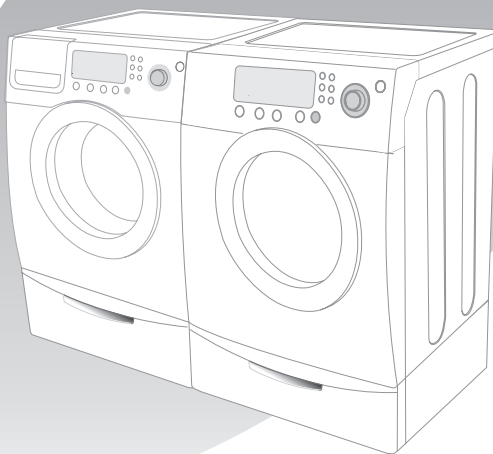

Register your product at  
[www.samsung.com/global/register](http://www.samsung.com/global/register)

Code No.: DC68-02347B-EN

# Safety Precautions

Congratulations on your new Samsung Dryer. This manual contains valuable information on the installation, use, and care of your appliance. Please take the time to read this manual to take full advantage of your dryer's many benefits and features.

## What you need to know about Safety Instructions

Warnings and Important Safety Instructions in this manual do not cover all possible conditions and situations that may occur. It is your responsibility to use common sense, caution, and care when installing, maintaining, or operating your dryer.

Always contact your manufacturer about problems or conditions you do not understand.

## RECOGNIZE SAFETY SYMBOLS, WORDS, LABELS



**WARNING** – Hazards or unsafe practices that COULD result in severe personal injury or death.



**CAUTION** – Hazards or unsafe practices that COULD result in minor personal injury or property damage.



**WARNING** – Follow the information in this manual to minimize the risk of fire or explosion or to prevent property damage, personal injury, or death. Do not store or use gasoline or other flammable vapors and liquids near this or any other appliance.

## WHAT TO DO IF YOU SMELL GAS:

- Do not try to light any appliance.
- Do not turn on the appliance.
- Do not touch any electrical switch.
- Do not use any phone in your building.
- Clear the room, building or area of all occupants.
- Immediately call your gas supplier from a neighbor's phone. Follow the gas supplier's instructions.
- If you cannot reach your gas supplier, call the fire department.

Installation and service must be performed by a qualified installer, service agency, or the gas supplier.



**WARNING** – To reduce the risk of fire, explosion, electric shock, or personal injury when using your dryer, follow the basic safety precautions below:

1. Read all instructions before using your appliance.
2. To avoid the possibility of fire or explosion:
  - a. Do not dry items that have been previously cleaned, washed, soaked, or spotted with gasoline, dry cleaning solvents, or other flammable or explosive substances. They emit vapors that could ignite or explode. Any material that has been in contact with a cleaning solvent or flammable liquids or solids should not be placed in the dryer until all traces of these flammable liquids or solids and their fumes have been removed.

There are many highly flammable items used in homes, such as acetone, denatured alcohol, gasoline, kerosene, some liquid household cleaners, some spot removers, turpentine, waxes, and wax removers.
  - b. Items containing foam rubber (may be labeled latex foam) or similarly textured rubber-like materials must not be dried on a heat setting. Heated foam rubber materials can, under certain circumstances, produce fire by spontaneous combustion.

## Safety Precautions

3. Do not allow children or pets to play on, in, or in front of the appliance. Close supervision is necessary when the appliance is used near children and pets.
4. Before discarding or removing your dryer from service, remove the door to the drying compartment to prevent children or animals from becoming trapped inside.
5. Do not reach into the appliance when the drum is moving.
6. Do not install or store this appliance where it will be exposed to the weather.
7. Do not tamper with controls.
8. Do not repair, replace, or attempt to service any part of the appliance unless specifically recommended in the user-repair instructions and you understand and have the skills to carry those out.
9. Do not use fabric softeners or products to eliminate static unless recommended for dryer use by the manufacturer of the fabric softener or product.
10. Clean the lint screen before or after each load.
11. Keep the area around the exhaust opening and surrounding areas free from lint, dust, and dirt.
12. The interior of the dryer and exhaust duct should be cleaned periodically by qualified service personnel.
13. This appliance must be properly grounded. Never plug the power cord into a receptacle that is not grounded adequately and in accordance with local and national codes. See installation instructions for grounding this appliance.
14. Do not sit on top of the dryer.  
**NOTE:** Because of continuing product improvements, Samsung reserves the right to change specifications without notice. For complete details, see the Installation Instructions packed with your product before selecting cabinetry, making cutouts, or beginning installation.
15. Ensure pockets are free from small irregularly shaped hard objects, foreign material, etc. ie. coins, knives, pins, etc. These objects could damage your dryer.
16. Do not wash clothing with large buckles, buttons, or other heavy metal or solid things.



**WARNING –** Gas leaks may occur in your system, resulting in a dangerous situation. Gas leaks may not be detected by smell alone. Gas suppliers recommend you purchase and install a UL-approved gas detector. Install and use in accordance with the manufacturer's instructions.



**WARNING –** Do not place items in your dryer that have been spotted or soaked with vegetable oil or cooking oil. Even after being washed, these items may contain significant amounts of these oils.

The residual oil can ignite spontaneously. The potential for spontaneous combustion increases when the items containing vegetable oil or cooking oil are exposed to heat. Heat sources such as your dryer can warm these items, allowing an oxidation reaction in the oil to occur. Oxidation creates heat. If this heat cannot escape, the items can become hot enough to catch fire. Piling, stacking, or storing these kinds of items may prevent heat from escaping and can create a fire hazard.

All washed and unwashed fabrics that contain vegetable oil or cooking oil can be dangerous. Washing these items in hot water with extra detergent will reduce, but not eliminate, the hazard. Always use the Cool Down cycle for these items to reduce their temperature. Never remove these items from the dryer hot or interrupt the drying cycle until the items have run through the Cool Down cycle. Never pile or stack these items when they are hot.

# Table of Contents

<b>Safety Precautions</b> .....	<b>inside cover</b>
<b>Installation Instructions</b> .....	<b>A-1</b>
Tools needed for installation .....	A-1
See Exhaust Requirements .....	A-1
DUCTING REQUIREMENTS .....	A-2
IMPORTANT TO INSTALLER .....	A-3
LOCATION CONSIDERATIONS .....	A-3
ALCOVE OR CLOSET INSTALLATION .....	A-3
MOBILE HOME INSTALLATION .....	A-4
EXHAUSTING .....	A-4
ELECTRICAL REQUIREMENTS .....	A-4
GROUNDING .....	A-4
ELECTRICAL CONNECTIONS .....	A-5
REPLACEMENT PARTS AND ACCESSORIES .....	A-5
INSTALLATION .....	A-5
FINAL INSTALLATION CHECKLIST .....	A-5
Dryer Exhaust Tips .....	A-6
Door Reversal .....	A-7
<b>Operating Instructions, Tips</b> .....	<b>B-1</b>
OVERVIEW OF THE CONTROL PANEL .....	B-1
CHILD LOCK .....	B-4
MY CYCLE .....	B-4
Rack Dry .....	B-5
CLEAN THE LINT FILTER .....	B-6
LOAD THE DRYER PROPERLY .....	B-6
GETTING STARTED .....	B-6
<b>Care and Cleaning</b> .....	<b>C-1</b>
Control Panel .....	C-1
Tumbler .....	C-1
Stainless Steel Tumbler (select models) .....	C-1
Dryer Exterior .....	C-1
Dryer Exhaust System .....	C-1
<b>Special Laundry Tips</b> .....	<b>D-1</b>
THINGS TO AVOID: .....	D-1
<b>Troubleshooting</b> .....	<b>E-1</b>
CHECK THESE POINTS IF YOUR DRYER... .....	E-1
INFORMATION CODES .....	E-2
<b>Appendix</b> .....	<b>F-1</b>
FABRIC CARE CHART .....	F-1
PROTECTING THE ENVIRONMENT .....	F-2
DECLARATION OF CONFORMITY .....	F-2
SPECIFICATION .....	F-2
CYCLE CHART .....	F-3

# Installation Instructions

## Tools needed for installation

Proper installation is the owner's responsibility.

HOWEVER, SERVICE CALLS PERFORMED AS A RESULT OF POOR SET-UP, ADJUSTMENT, AND CONNECTION ARE THE RESPONSIBILITY OF THE INSTALLER.

Make sure you have everything necessary for proper installation.

1. GROUNDED ELECTRICAL OUTLET is required. See Electrical Requirements.
2. EXHAUST SYSTEM – must be rigid metal or flexible stiff-walled metal exhaust ducting.

## See Exhaust Requirements.

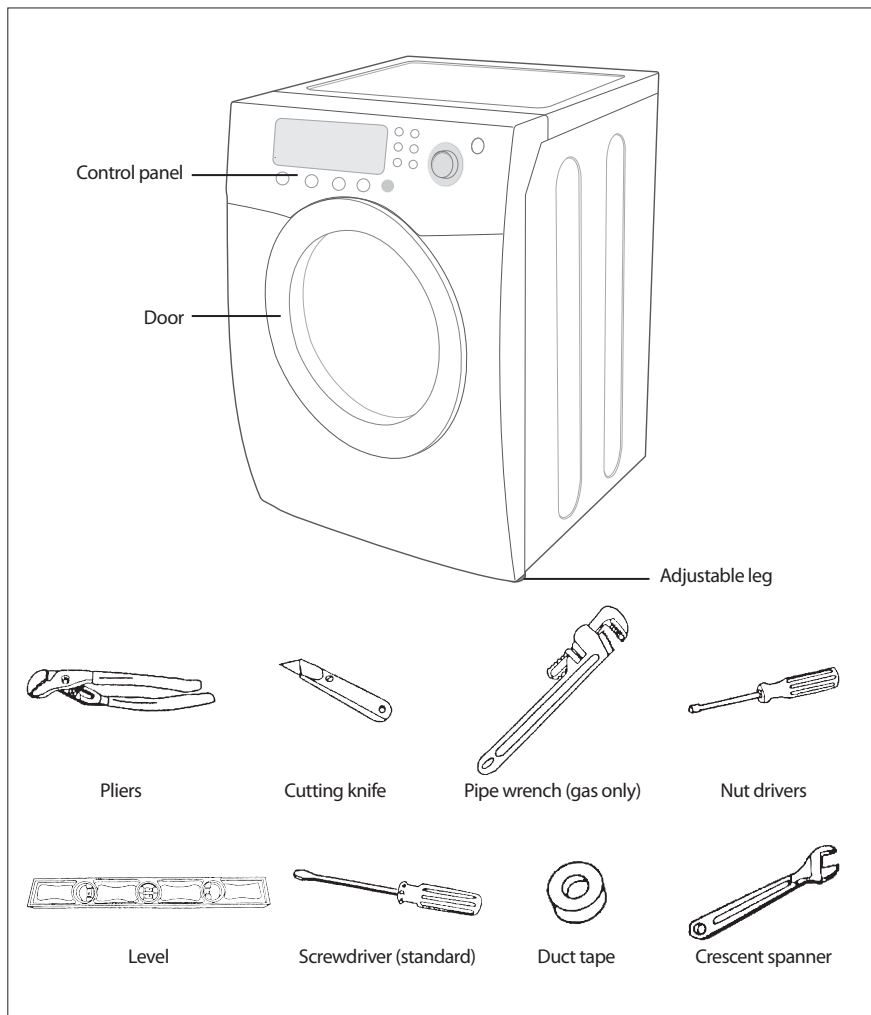

# Installation Instructions

## DUCTING REQUIREMENTS

- Use a 4-inch (10.2 cm) diameter rigid aluminum or rigid galvanized steel duct.
- Do not use a smaller duct.
- Ducts larger than 4 inches (10.2 cm) in diameter can result in increased lint accumulation. Lint accumulation should be cleaned regularly.
- If a flexible metal duct must be used, use the type with a stiff sheet metal wall. Do not use a flexible duct with a thin foil wall. Serious blockage can result if the flexible metal duct is bent too sharply.
- Never install any type of flexible duct in walls, ceilings, or other concealed spaces.
- Keep exhaust duct as straight and short as possible.
- Secure joints with duct tape. Do not use screws.
- DO NOT EXHAUST DRYER INTO ANY WALL, CEILING, CRAWL SPACE, OR CONCEALED SPACE OF A BUILDING, GAS VENT, OR ANY OTHER COMMON DUCT OR CHIMNEY. THIS COULD CREATE A FIRE HAZARD FROM LINT EXPELLED BY THE DRYER.
- Plastic flexible duct can kink, sag, be punctured, reduce airflow, extend drying times, and affect dryer operation.
- Exhaust systems longer than recommended can extend drying times, affect machine operation, and may collect lint.
- The exhaust duct should end with an exhaust hood with a swing-out damper to prevent back drafts and entry of wildlife. Never use an exhaust hood with a magnetic damper.
- The hood should have at least 12 inches (30.5 cm) of clearance between the bottom of the hood and the ground or other obstruction. The hood opening should point down.
- Never install a screen over the exhaust outlet.
- To avoid lint buildup, do not exhaust the dryer directly into a window well. Do not exhaust under a house or porch.
- If exhaust ductwork must run through an unheated area, the duct should be insulated and slope slightly down towards the exhaust hood to reduce condensation and lint buildup.
- Inspect and clean the interior of the exhaust system at least once a year. Unplug the power cord before cleaning.
- Check frequently to be sure the exhaust hood damper opens and closes freely.
- Check once per month, and clean at least one time per year. Note: If clothes are not getting dry, then check ducting for obstructions.

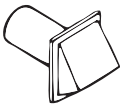
ELECTRIC AND GAS DRYER				
Weather Hood Type				
Recommended			Use only for short-run installation	
 4" (10.16 cm)			 2.5" (6.35 cm)	
No. of 90° elbows	Rigid	Metallic Flexible*	Rigid	Metallic Flexible*
0	24.4 m (80 ft.)	12.4 m (41 ft.)	22.6 m (74 ft.)	10.1 m (33 ft.)
1	20.7 m (68 ft.)	11.2 m (37 ft.)	18.9 m (62 ft.)	8.8 m (29 ft.)
2	17.4 m (57 ft.)	10.1 m (33 ft.)	15.5 m (51 ft.)	7.6 m (25 ft.)
3	14.3m (47 ft.)	9.0 m (29 ft.)	12.5 m (41 ft.)	6.5 m (21 ft.)

\* Do not use non-metallic flexible duct.

## Installation Instructions

### If new dryer is installed into an existing exhaust system you must make sure:

- The exhaust system meets all local, state, and national codes.
- That flexible plastic duct is not used.
- Inspect and clean all lint buildup from inside the existing duct.
- The duct is not kinked or crushed.
- The exhaust hood damper opens and closes freely.

The static pressure in any exhaust system must not exceed 0.83 inches of water column, or be less than 0. This can be measured with the dryer running with a manometer at the point where the exhaust duct connects to the dryer. A no-heat setting should be used. The dryer tumbler should be empty and the lint filter clean.

### IMPORTANT TO INSTALLER

Please read the following instructions carefully before installing the dryer. These instructions should be kept for future reference.

**REMOVE THE DOOR FROM ALL DISCARDED APPLIANCES TO AVOID THE DANGER OF A CHILD SUFFOCATING.**

### LOCATION CONSIDERATIONS

The dryer should be located where there is enough space in front for loading the dryer, and enough space behind for the exhaust system. This dryer is factory-ready for rear exhaust. To exhaust out the bottom or the left, use the accessory exhaust kit. Instructions are included with the kit. It's important to make sure the room has enough fresh air. The dryer must be located where there is no air-flow obstruction.

THE DRYER MUST NOT BE INSTALLED OR STORED IN AN AREA WHERE IT WILL BE EXPOSED TO WATER AND/OR WEATHER. THE DRYER AREA IS TO BE KEPT CLEAR OF COMBUSTIBLE MATERIALS, GASOLINE, AND OTHER FLAMMABLE VAPORS AND LIQUIDS. A DRYER PRODUCES COMBUSTIBLE LINT. THE AREA AROUND THE DRYER SHOULD BE KEPT LINT-FREE.

### ALCOVE OR CLOSET INSTALLATION



**WARNING** – The dryer must be exhausted to the outside to reduce the risk of fire when installed in an alcove or closet.

- No other fuel-burning appliance should be installed in the same closet as the dryer.
- **WARNING:** To reduce the risk of fire, this dryer **MUST BE EXHAUSTED TO THE OUTDOORS.** See EXHAUST INFORMATION section.
- Minimum clearances between the dryer and adjacent walls or other surfaces are: 2" in front, 17" on top, 1" on either side, and 2.375" in the back.
- Closet front must have two unobstructed air openings for a combined minimum total area of 72 in<sup>2</sup> with 3" minimum clearance on the top and bottom. A louvered door with equivalent space clearance is acceptable.

# Installation Instructions

## MOBILE HOME INSTALLATION

The installation of the dryer in mobile homes must conform to CSA Standards Z240 (for Canada). When installing a dryer in a mobile home, provisions for anchoring the dryer to the floor must be made. Locate in an area that has adequate fresh air. A minimum of 72 in<sup>2</sup> (183 cm<sup>2</sup>) of unobstructed space is required. Call 1-800-SAMSUNG for information on purchasing the Floor Anchoring Kit as an accessory. All mobile home installations must be exhausted to the outside with the exhaust duct termination securely fastened to the mobile home structure, using materials that will not support combustion. The exhaust duct may not terminate underneath the mobile home. See Exhausting section for more information.

## EXHAUSTING

Exhausting the dryer to the outside will prevent large amounts of lint and moisture from being blown into the room.

- All dryers must be exhausted to the outside.



**WARNING** – The dryer must be exhausted to the outside to reduce the risk of fire when installed in an alcove or closet.  
**NEVER USE PLASTIC OR NON-METAL FLEXIBLE DUCT.**  
If your existing ductwork is plastic, non-metal, or combustible, replace it with metal.  
Use only metal exhaust duct that is non-flammable to ensure containment of exhaust air, heat, and lint.

## ELECTRICAL REQUIREMENTS

**NOTE:** Wiring diagram is located on plate below the control panel.

### **WARNING** –

- Improper connection of the equipment grounding conductor can result in a risk of electric shock. Check with a qualified electrician or serviceman if you are in doubt as to whether your dryer is properly grounded. Do not modify the plug provided with your dryer – if it doesn't fit the outlet, have a proper outlet installed by a qualified electrician.
- To prevent unnecessary risk of fire, electrical shock, or personal injury, all wiring and grounding must be done in accordance with local codes, or in the absence of local codes, with the Canadian Electrical Code CSA C22.1 – Latest Revisions and local codes and ordinances. It is your responsibility to provide adequate electrical services for your dryer.

## GROUNDING

This dryer must be grounded. In the event of malfunction or breakdown, the ground will reduce the risk of electrical shock by providing a path of least resistance for electrical current.

The plug must be plugged into an appropriate outlet that is properly installed and grounded in accordance with all local codes and ordinances.

If a power cord is not used and the electric dryer is to be permanently wired, the dryer must be connected to a permanent grounded metal wiring system, or an equipment grounding conductor must be run with the circuit conductors and connected to the equipment grounding terminal.



# Installation Instructions

## ELECTRICAL CONNECTIONS

Before operating or testing, follow all grounding instructions in the Grounding section. An individual branch (or separate) circuit serving only your dryer is recommended. DO NOT USE AN EXTENSION CORD.

- A 120/240 volt, 60 Hz AC approved electrical service fused through a 30-ampere fuse or circuit breaker on both sides of the line is required.
- The power cord should be plugged into a 30-ampere receptacle.

**NOTE:** It is not permissible to convert a dryer in Canada to 208 volts.

## REPLACEMENT PARTS AND ACCESSORIES

If your dryer requires replacement parts or accessories, contact the dealer from whom you purchased your dryer or the SAMSUNG customer care center at 1-800-SAMSUNG (726-7864).

## INSTALLATION

*Parts and literature are packaged inside your dryer drum. To install:*

1. Move your dryer to an appropriate location for installation. Consider installing the dryer and washer side-by-side, to allow access to electrical, and exhaust connections. Lay two of the carton cushion-tops on the floor. Tip your dryer on its side so it will lay across both cushion-tops.
2. Set your dryer back in an upright position.
3. Review the Exhausting section before installing the exhaust system. Install the ductwork from your dryer to the exhaust hood. The crimped end of the duct sections must point away from your dryer. DO NOT use sheet metal screws when assembling ducting. These joints should be taped.

**Never use plastic flexible exhaust material.**

Tip for tight installations: install a section of exhaust system to your dryer before putting it in place. Use duct tape to secure this section to your dryer, but do not cover louvers in dryer cabinet.

4. Review Electrical Requirements section.  
BEFORE OPERATING OR TESTING, follow the grounding instructions in the Grounding section.
5. With a level, check your dryer and make necessary adjustments to the leveling legs.
6. At this time, make sure all exhaust and electrical connections are complete. Plug in your dryer, and check operation by using the checklist below.

## FINAL INSTALLATION CHECKLIST

- Dryer is plugged into electrical outlet and properly grounded.
- Exhaust ductwork is hooked up and joints taped.
- Plastic flexible duct is NOT used.
- Use rigid or stiff-walled flexible metal vent material.
- Dryer is level with all legs firmly on the floor.
- Start your dryer to confirm that it runs, heats, and shuts off.

## Installation Instructions

### Dryer Exhaust Tips

**WARNING:** Plastic or non-metal flexible duct presents a potential fire hazard.

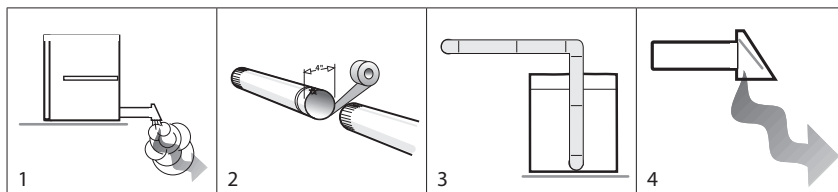

1. Let your dryer exhaust the air easily.
2. Use 4" diameter rigid metal duct. Tape all joints, including at the dryer. Never use lint-trapping screws.
3. Keep ducts as straight as possible.
4. Clean all old ducts before installing your new dryer. Be sure vent flap opens and closes freely. Inspect and clean the exhaust system annually.

### Don't let a poor exhaust system slow drying by:

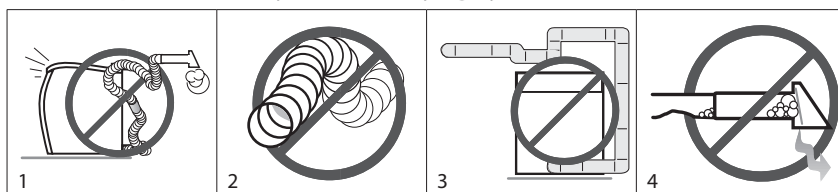

1. Restricting your dryer with a poor exhaust system.
2. Using a plastic, thin foil, or non-metal flexible duct.
3. Using unnecessarily long duct runs with many elbows.
4. Allowing crushed or clogged ducts and vent.

## Installation Instructions

### Door Reversal

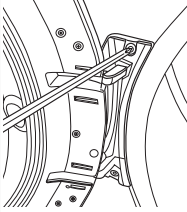
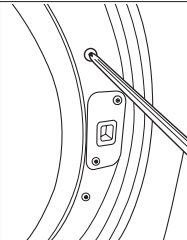
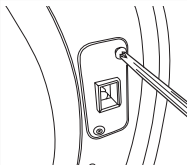
<ol style="list-style-type: none"><li>1. Unplug power cord.</li><li>2. Remove two door hinge screws.</li><li>3. Lift the door and remove from dryer.</li></ol>		<ol style="list-style-type: none"><li>6. Place the door on the other side and reattach it to dryer.</li></ol>
<ol style="list-style-type: none"><li>4. Remove two screws on the opposite side of door hinge.</li></ol>		<ol style="list-style-type: none"><li>7. Reassemble holder lever.</li></ol>
<ol style="list-style-type: none"><li>5. Remove two screws on holder lever.</li></ol>		<ol style="list-style-type: none"><li>8. Reassemble the screws in the remaining holes.</li></ol>

# Operating Instructions, Tips

\* Control Features vary by model.

## OVERVIEW OF THE CONTROL PANEL

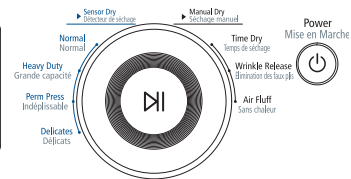
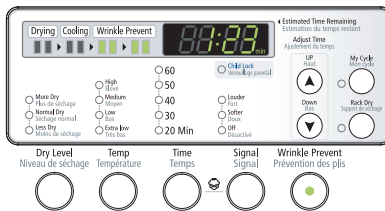
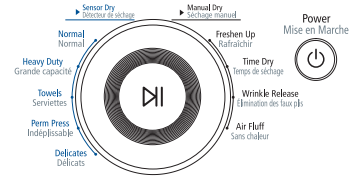
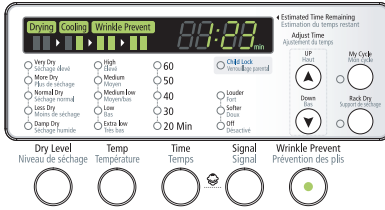
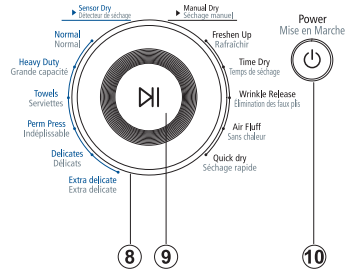
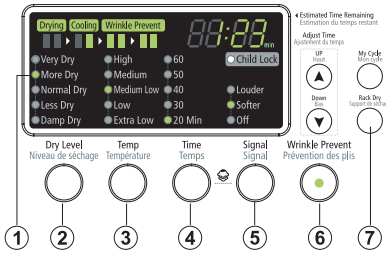

## Operating Instructions, Tips

### 1. Digital Graphic Display

The display window shows the estimated time remaining in the cycle after the Cycle Selector dial is pressed. The estimated time remaining may fluctuate as the cycle progresses.

The Drying light will illuminate and remain lit until the cycle is complete.

When your dryer is in the cool-down phase, the Cooling light will illuminate.

When your dryer is in the wrinkle prevent phase, the Wrinkle Prevent light will illuminate.

When the cycle is complete, "END" will appear in the display panel until the dryer door is opened or Power key is pushed.

If your dryer is paused during a cycle, the indicator lights will blink until the Cycle Selector dial is pressed.

### 2. Dry Level Selection Button

To select the dry level in the Normal, Heavy Duty, or other Sensor Dry cycles, press the Dry Level button. An indicator light will illuminate next to the desired dryness level.

Press the button repeatedly to scroll through the settings. Larger or bulkier loads may require the Very Dry (select models) or More Dry setting for complete dryness.

The Less Dry setting is best suited for lightweight fabrics or for leaving some moisture in the clothing at the end of the cycle. Damp Dry (select models) is designed to partially dry items.

Use for items that lay flat or hang to dry.

### 3. Temp Selection Button

To select the correct temperature for the load, press the Temp button. An indicator light will illuminate next to the desired temperature. Press the button repeatedly to scroll through the settings.

**High** – For sturdy cottons or those labeled Tumble Dry.

**Medium** – For permanent press, synthetics, lightweight cottons, or items labeled Tumble Dry Medium.

**Medium Low** – For lower heat than Medium to dry synthetic or washable knit fabrics.

**Low** – For heat sensitive items labeled Tumble Dry Low or Tumble Dry Warm.

**Extra Low** – Provides the lowest heated dry temperature possible.

### 4. Time Selection Button

When using Manual Dry cycles, time can be adjusted by pressing time selection button.

During the Sensory Dry cycle, the time light indicator is off because exact drying times are determined by fluctuating humidity levels.

### 5. Signal Selection Button

When the cycle is complete, a chime will sound.

When the Wrinkle Prevent option is selected, the chime will sound intermittently.

Adjust the volume of the chime or turn it off by pressing the Signal button.

Press the button repeatedly to scroll through the choices.

### 6. Wrinkle Prevent Selection Button

Wrinkle Prevent provides approximately 90 minutes of intermittent tumbling in unheated air at the end of the cycle to reduce wrinkling. Press the Wrinkle Prevent button to activate this feature.

The indicator light above the pad will illuminate when Wrinkle Prevent is selected.

Chasing lights appear in the display when the Wrinkle Prevent option is selected. The load is dry, and can be removed at any time during the Wrinkle Prevent cycle.

## Operating Instructions, Tips

### 7. Select Cycle Option

**Adjust Time** – Time can be added or subtracted from the automatically set times in the Manual Dry cycles (Time Dry, Freshen Up, Delicates, Wrinkle Release, or Air Fluff cycles).

To add or subtract time from the cycle, press the Adjust Time arrow pad up or down until the desired time is displayed.

**My Cycle** – Choose your favorite cycle including cycle, temp, dry level option, etc. (See page B4 for detail.)

**Rack Dry** – Rack Dry is available at Time Dry cycle. Temperature will be set only to Extra Low. (See page B5 for detail.)

### 8. Cycle Selector

To select a cycle, rotate the Cycle Selector dial to the desired cycle.

The indicator light by the cycle name will illuminate. The Normal, Heavy Duty, Towels, Perm Press and Delicates cycles are Sensor Dry cycles.

Sensor Dry automatically senses the moisture in the load and shuts the dryer off when the selected dryness level (very dry to damp dry) is reached.

**Normal** – Dry loads such as cotton, underwear, and linens use this cycle to get various levels of heat for drying.

**Heavy Duty** – Use this cycle to get high heat for heavy fabrics such as jeans, corduroys, or work clothes.

**Towels** – Dry loads such as bath towels.

**Perm Press** – Dry wrinkle-free cottons, synthetic fabrics, knits, and permanent press fabrics automatically. The cycle minimizes wrinkling by providing a longer unheated cool-down period at the end of the cycle.

**Delicates** – The Delicates cycle is designed to dry heat-sensitive items at a low drying temperature.

**Freshen Up** – This cycle removes odors and freshens garments.

**Time Dry** – Time Dry allows you to select the desired cycle time in minutes.

Turn the Cycle Selector dial to Time Dry, then press the Adjust Time up arrow to set the drying time. Press the arrow repeatedly to scroll through the time settings.

**Wrinkle Release** – The Wrinkle Release cycle will release wrinkles from items that are clean, dry, and only slightly wrinkled, such as clothes from a crowded closet, suitcase or items that have been in the dryer too long after the cycle has ended. Wrinkle Release can be used with any temperature selection.

**Air Fluff** – The Air Fluff cycle tumbles the load in room temperature air.

### 9. Start/Pause Selection Button

Press to pause and restart programs.

### 10. Power Button

Press once to turn your dryer on, press again to turn it off. If your dryer is left on for more than 10 minutes without any buttons being touched, the power automatically turns off.

### CHILD LOCK

A function to prevent children from playing with your dryer.

#### SETTING/RELEASING

If you want to set or release Child Lock, press both the Time and Signal buttons at the same time for 3 seconds.

##### **How to Set:**

1. It can be set while your dryer is running.
2. Once you set the Child Lock function, no button, except for the Power button, can be controlled until you release the Child Lock function.
3. The Child Lock indicator will be lit.

##### **Notice:**

1. If the power is on again, the Child Lock function remains unchanged.
2. To release that function, follow the instructions above.

##### **Notice:**

When other buttons, except for the Power button, do not respond, check the Child Lock indicator.

### MY CYCLE

Lets you activate your customized cycle that includes Dry Level, Temp, Time option, etc.

By pushing the My Cycle button, you activate the settings used during the previous My Cycle mode. (Default : Normal Cycle)

If My Cycle mode is activated, My Cycle lamp will be lit.

**You can select all options in My Cycle mode as follows.**

1. Select cycle using Cycle Selector dial.
2. After cycle selection, set each option.  
**Note:** At this time, the option will follow as per each cycle's default option selection.
3. Then, you can start My Cycle by pushing the Start/Pause button in My Cycle mode. The cycle and options you select will be displayed next time you choose My Cycle.

**Note:** You can change My Cycle setting by repeating same process above.  
The last used setting will be displayed at next time you choose My Cycle.

## Operating Instructions, Tips

### Rack Dry

#### INSTALLING THE DRYING RACK

1. Open dryer door.
2. Position drying rack in tumbler, placing the rear legs in the two recessed areas of the dryer's back wall.
3. Place the front lip of the drying rack on top of the lint filter.
4. Place items to be dried on the rack, leaving space between them so air can reach all surfaces.
5. Close dryer door.
6. Use the Time Dry cycle. Select time according to moisture and weight of the items. Start dryer. It may be necessary to reset the timer if a longer drying time is needed.

SUGGESTED ITEMS	SUGGESTED TEMP. SETTINGS
Washable sweaters (block to shape and lay flat on rack)	Heat (Low/Extra Low)
Stuffed toys (cotton or polyester fiberfilled)	Heat (Low/Extra Low)
Stuffed toys (foam or rubber-filled)	Air Fluff
Foam rubber pillows	Air Fluff
Sneakers	Fluff or Heat

**WARNING** – Drying foam rubber, plastic, or rubber on a heat setting may cause damage to the item and lead to a fire hazard.

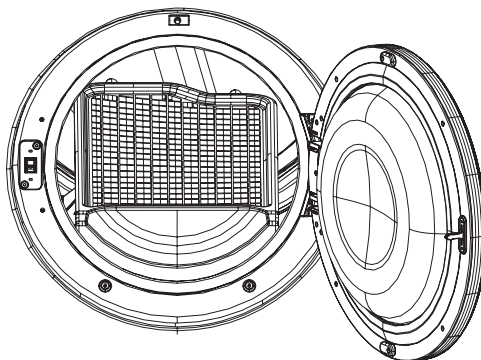



### CLEAN THE LINT FILTER

- After each load.
  - To shorten drying time.
  - To operate more energy efficiently.
- NOTE:** Do not operate your dryer without the lint filter in place.

### LOAD THE DRYER PROPERLY

- Place only one washload in your dryer at a time.
- Mixed loads of heavy and lightweight fabrics will dry differently, which may result in lightweight fabrics being dry while heavy fabrics remaining damp at the end of a drying cycle.
- Add one or more similar items to your dryer when only one or two articles need drying. This improves the tumbling action and drying efficiency.
- Overloading restricts tumbling action, resulting in uneven drying as well as excessive wrinkling of some fabrics.

### GETTING STARTED

1. Load your dryer loosely – DO NOT overload.
  2. Close the door.
  3. Select the appropriate cycle and options for the load (see pages B-2, B-3).
  4. Press the Cycle Selector dial.
  5. The dryer indicator light will illuminate.
  6. The estimated cycle time will appear in the display.
- The time may fluctuate to better indicate drying time remaining in the cycle.

**NOTES:**

- When the cycle is complete, the Door Lock light will go out and “End” will appear in the display.
- Pressing Power cancels the cycle and stops your dryer.
- The Drying, Cooling, and Wrinkle Prevent indicator lights will illuminate during those portions of the cycle.

## Care and Cleaning

### Control Panel

Clean with a soft, damp cloth. Do not use abrasive substances.

Do not spray cleaners directly on the panel.

The control panel finish could be damaged by some laundry pre-treatment soil and stain remover products.

Apply such products away from your dryer and wipe up any spills or overspray immediately.

### Tumbler

Remove any stains such as crayon, ink, or fabric dye (from new items such as towels or jeans) with an all-purpose cleaner.

Then tumble old towels or rags to remove any excess stain or cleaning substance.

Once these steps are done, stains may still be visible, but should not transfer to subsequent loads.

### Stainless Steel Tumbler (select models)

To clean the stainless steel tumbler, use a damp cloth with a mild, non-abrasive cleaner suitable for stainless steel surfaces.

Remove the cleaner residue and dry with a clean cloth.

### Dryer Exterior

Clean with a soft, damp cloth. Do not use abrasive substances.

Protect the surface from sharp objects.

### Dryer Exhaust System

Should be inspected and cleaned yearly to maintain optimum performance.

The outside exhaust hood should be cleaned more frequently to ensure proper operation.

## Special Laundry Tips

Please follow the care label or manufacturer's instructions for drying special items. If care label instructions are not available, use the following information as a guide.

<b>Bedspreads &amp; Comforters</b>	<ul style="list-style-type: none"> <li>Follow the care label instructions or dry on the Normal cycle and High temperature.</li> <li>Make sure the item is thoroughly dry before using or storing.</li> <li>May require repositioning to ensure even drying.</li> </ul>
<b>Blankets</b>	<ul style="list-style-type: none"> <li>Use Normal and dry only one blanket at a time for best tumbling action.</li> <li>Make sure the item is thoroughly dry before using or storing.</li> </ul>
<b>Curtains &amp; Draperies</b>	<ul style="list-style-type: none"> <li>Use the Perm Press cycle and Low or Extra Low temperature to help minimize wrinkling.</li> <li>Dry these in small loads for best results and remove as soon as possible.</li> </ul>
<b>Cloth Diapers</b>	<ul style="list-style-type: none"> <li>Use the Normal cycle and the High temperature setting for soft, fluffy diapers.</li> </ul>
<b>Down-filled Items (jackets, sleeping bags, comforters, etc.)</b>	<ul style="list-style-type: none"> <li>Use the Normal cycle and the Low or Extra Low temperature setting.</li> <li>Place a clean pair of sneakers in your dryer with the item to fluff the down comforters, etc. Adding a couple of dry towels shortens drying time and absorbs moisture.</li> </ul>
<b>Foam Rubber (rug backs, stuffed toys, shoulder pads, etc.)</b>	<ul style="list-style-type: none"> <li>DO NOT dry on a heat setting. Use the Air Fluff cycle (no heat).</li> <li>WARNING – Drying a rubber item with heat may damage it or be a fire hazard.</li> </ul>
<b>Pillows</b>	<ul style="list-style-type: none"> <li>Use the Normal cycle.</li> <li>Add a couple of dry towels and a pair of clean sneakers to help the tumbling action and to fluff the item.</li> <li>DO NOT dry kapok or foam pillows in dryer.</li> </ul>
<b>Plastics (shower curtains, outdoor furniture covers, etc.)</b>	<ul style="list-style-type: none"> <li>Use the Air Fluff cycle or the Time Dry cycle and the Low or Extra Low temperature setting depending on the care label instructions.</li> </ul>

### THINGS TO AVOID :

- Fiberglass items (curtains, draperies, etc.).
- Woolens, unless recommended on the label.
- Vegetable or cooking oil-soaked items.

## Troubleshooting

### CHECK THESE POINTS IF YOUR DRYER...

<b>doesn't run.</b>	<ul style="list-style-type: none"> <li>• Be sure the door is latched shut.</li> <li>• Be sure the power cord is plugged into a live electrical outlet.</li> <li>• Check the home's circuit breaker and fuses.</li> <li>• Press the Cycle Selector dial again if the door is opened during the cycle.</li> </ul>
<b>doesn't heat.</b>	<ul style="list-style-type: none"> <li>• Check the home's circuit breaker and fuses.</li> <li>• Select a heat setting other than Air Fluff.</li> <li>• Clean the lint filter and exhaust duct.</li> <li>• Dryer may have moved into the cool-down phase of the cycle.</li> </ul>
<b>doesn't dry.</b>	<ul style="list-style-type: none"> <li>• Check all of the above, plus...</li> <li>• Be sure the exhaust hood outside the home can open and close freely.</li> <li>• Check exhaust system for lint buildup. Ducting should be inspected and cleaned annually.</li> <li>• Use 4" rigid metal exhaust duct.</li> <li>• Do not overload. 1 wash load = 1 dryer load.</li> <li>• Sort heavy items from lightweight items.</li> <li>• Large, bulky items like blankets or comforters may require repositioning to ensure even drying.</li> <li>• Check that the washer is draining properly to extract adequate water from the load.</li> <li>• Load may be too small to tumble properly. Add a few towels.</li> </ul>
<b>is noisy.</b>	<ul style="list-style-type: none"> <li>• Check the load for objects such as coins, loose buttons, nails, etc. Remove promptly.</li> <li>• It is normal to hear the dryer gas valve or heating element cycle on and off during the drying cycle.</li> <li>• Be sure the dryer is leveled properly as outlined in the installation instruction.</li> <li>• It is normal for the dryer to hum from the high velocity of air moving through the dryer drum and exhaust system.</li> </ul>
<b>dries unevenly.</b>	<ul style="list-style-type: none"> <li>• Seams, pockets, and other similarly heavy areas may not be completely dry when the rest of the load has reached the selected dryness level. This is normal. Select the Very Dry setting if desired.</li> <li>• If one heavy item is dried with a lightweight load, such as one towel with sheets, it is possible that the heavy item will not be completely dry when the rest of the load has reached the selected dryness level. Sort heavy items from lightweight items for best drying results.</li> </ul>
<b>has an odor.</b>	<ul style="list-style-type: none"> <li>• Household odors from painting, varnishing, strong cleaners, etc. may enter the dryer with the surrounding room air. This is normal as the dryer draws the air from the room, heats it, pulls it through the tumbler, and exhausts it outside.</li> <li>• When these odors linger in the air, ventilate the room completely before using the dryer.</li> </ul>
<b>shuts off before load is dry</b>	<ul style="list-style-type: none"> <li>• Dryer load is too small. Add more items or a few towels and restart the cycle.</li> <li>• Dryer load is too large. Remove some items and restart the dryer.</li> </ul>

## Troubleshooting

### INFORMATION CODES

Information codes may be displayed to help you better understand what is occurring with the dryer.

































Code Symbol	Meaning	Solution
LS	Heater temperature control problem.	Call for service. See below.
dF	Door open sensing problem.	Call for service. See below.
dO	Door open error When the door is open, the dryer will not operate.	Be sure the door is latched shut. If problem continues, call for service. See below.

For any codes not listed above, call 1-800-726-7864 (1-800-SAMSUNG).

## Appendix

### FABRIC CARE CHART

The following symbols provide garment care directions without words. The care label will include, in order, four symbols: washing, bleaching, drying, and ironing (or dry cleaning when necessary). The use of symbols ensures consistency among garment manufacturers of domestic and imported items. Follow care label directions to maximize garment life and reduce laundering problems.

Wash Cycle		Special Instructions		Warning Symbols for Laundering	
	Normal		Line Dry/ Hang to Dry		Do Not Wash
	Permanent Press/ Wrinkle Resistant/ Wrinkle Control		Drip Dry		Do Not Wring
	Gentle/Delicates		Dry Flat		Do Not Bleach
	Hand Wash	<b>Heat Setting</b>			Do Not Tumble Dry
<b>Water Temperature**</b>			High		No Steam (added to iron)
	Hot		Medium		Do Not Iron
	Warm		Low		
	Cold		Any Heat		
<b>Bleach</b>			No Heat/Air		
	Any Bleach (when needed)	<b>Iron-Dry or Steam Temperatures</b>			Line Dry/ Hang to Dry
	Only Non-Chlorine (color-safe) Bleach (when needed)		High		Drip Dry
	Tumble Dry Cycle		Medium		Dry Flat
<b>Normal</b>			Low		
	Permanent Press/ Wrinkle Resistant/ Wrinkle Control	<b>Dryclean</b>			
	Gentle/ Delicates		Dry Clean		
			Do Not Dry Clean		

\*\* The dot symbols represent appropriate wash water temperatures for various items. The temperature range for Hot is 105° – 125° F/ 41° – 52° C, for Warm 85° – 105° F/29° – 41° C and for Cold 60° – 85° F/16° – 29° C. (Wash water temperature must be a minimum of 60° F/16° C for detergent activation and effective cleaning.)

## Appendix

### PROTECTING THE ENVIRONMENT

This appliance is manufactured from recyclable materials. If you decide to dispose of this appliance, please observe local waste disposal regulations. Cut off the power cord so that the appliance cannot be connected to a power source. Remove the door so that animals and small children cannot get trapped inside the appliance.

### DECLARATION OF CONFORMITY

This appliance complies with UL2158.

### SPECIFICATION

TYPE	FRONT LOADING DRYER			
DIMENSION	Div	Inches (cm)	Div	Inches (cm)
	A. Height	38" (96.5)	C. Depth with door open 90°	49" (124.5)
	B. Width	27" (68.6)	D. Depth	30.25" (77.0)
WEIGHT	56.8 kg			
HEATER RATING	5300 W			
POWER CONSUMPTION	NO HEAT		268 W	
	HEATING		5445 W	

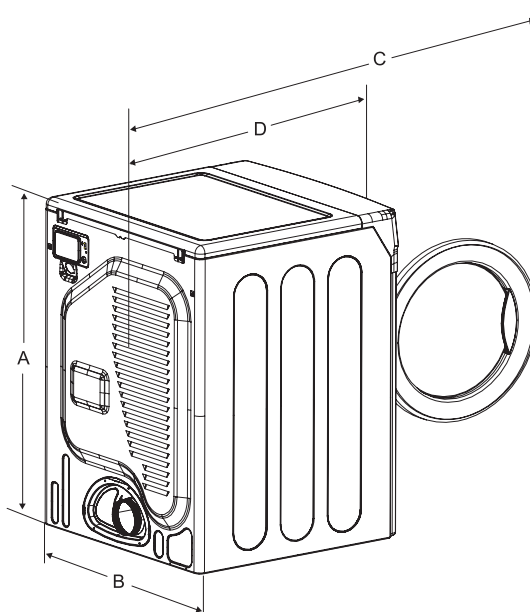

## Appendix

### CYCLE CHART

Cycle		Default			Drying	Cooling	Wrinkle prevent
		Temp control	Sensor dry level	Time	Time	Time	Time
<b>Sensor Dry</b>	<b>Normal</b>	High (Medium)	Normal dry	44 min	39 min	5 min	90 min
	<b>Heavy Duty</b>	High (No change)	Normal dry	60 min	55 min	5 min	90 min
	<b>Towels</b>	High (Medium)	Normal dry	52 min	47 min	5 min	90 min
	<b>Perm Press</b>	Medium Low (No change)	Normal dry	34 min	24 min	10 min	90 min
	<b>Delicates</b>	Low (No change)	Normal dry	29 min	24 min	5 min	90 min
	<b>Extra Delicates</b>	Extra Low (No change)	Normal dry	29 min	24 min	5 min	90 min
<b>Manual Dry</b>	<b>Freshen Up</b>	High (No change)	-	30 min	25 min	5 min	-
	<b>Time Dry</b>	High	-	40 min	35 min	5 min	-
	<b>Wrinkle Release</b>	Medium	-	25 min	20 min	5 min	-
	<b>Air Fluff</b>	-(No change)	-	20 min		20 min	
	<b>Quick Dry</b>	High	-	30 min	25 min	5 min	-



## Appendix

### SAMSUNG DRYER

#### LIMITED WARRANTY TO ORIGINAL PURCHASER

This SAMSUNG brand product, as supplied and distributed by SAMSUNG ELECTRONICS CANADA, INC. (SAMSUNG) and delivered new, in the original carton to the original consumer purchaser, is warranted by SAMSUNG against manufacturing defects in materials and workmanship for a limited warranty period of:

#### **One (1) Year All Parts and Labor, Two (2) Years Control Board Parts**

This limited warranty begins on the original date of purchase, and is valid only on products purchased and used in Canada.

To receive warranty service, the purchaser must contact SAMSUNG for problem determination and service procedures.

Warranty service can only be performed by a SAMSUNG authorized service center.

The original dated bill of sale must be presented upon request as proof of purchase to SAMSUNG or SAMSUNG's authorized service center.

SAMSUNG will provide in-home service during the warranty period at no charge, subject to availability within Canada.

In-home service is not available in all areas.

To receive in-home service, product must be unobstructed and accessible to the service agent.

If service is not available, SAMSUNG may elect to provide transportation of the product to and from an authorized service center.

SAMSUNG will repair, replace, or refund this product at our option and at no charge as stipulated herein, with new or reconditioned parts or products if found to be defective during the limited warranty period specified above.

All replaced parts and products become the property of SAMSUNG and must be returned to SAMSUNG. Replacement parts and products assume the remaining original warranty, or ninety (90) days, whichever is longer.

This limited warranty covers manufacturing defects in materials and workmanship encountered in normal, noncommercial use of this product and shall not apply to the following: damage that occurs in shipment; delivery and installation; applications and uses for which this product was not intended; altered product or serial numbers; cosmetic damage or exterior finish; accidents, abuse, neglect, fire, water, lightning, or other acts of nature or God; use of products, equipment, systems, utilities, services, parts, supplies, accessories, applications, installations, repairs, external wiring or connectors not supplied or authorized by SAMSUNG that damage this product or result in service problems; incorrect electrical line voltage, fluctuations and surges; customer adjustments and failure to follow operating instructions, maintenance and environmental instructions that are covered and prescribed in the instruction book; product removal and reinstallation; problems caused by pest infestations.

This limited warranty does not cover problems resulting from incorrect electric current, voltage or supply, light bulbs, house fuses, house wiring, cost of a service call for instructions, or fixing installation errors.

SAMSUNG does not warrant uninterrupted or error-free operation of the product.

## Appendix

EXCEPT AS SET FORTH HEREIN, THERE ARE NO WARRANTIES ON THIS PRODUCT EITHER EXPRESS OR IMPLIED, AND SAMSUNG DISCLAIMS ALL WARRANTIES INCLUDING, BUT NOT LIMITED TO, ANY IMPLIED WARRANTIES OF MERCHANTABILITY, INFRINGEMENT OR FITNESS FOR A PARTICULAR PURPOSE.

NO WARRANTY OR GUARANTEE GIVEN BY ANY PERSON, FIRM, OR CORPORATION WITH RESPECT TO THIS PRODUCT SHALL BE BINDING ON SAMSUNG.

SAMSUNG SHALL NOT BE LIABLE FOR LOSS OF REVENUE OR PROFITS, FAILURE TO REALIZE SAVINGS OR OTHER BENEFITS, OR ANY OTHER SPECIAL, INCIDENTAL OR CONSEQUENTIAL DAMAGES CAUSED BY THE USE, MISUSE, OR INABILITY TO USE THIS PRODUCT, REGARDLESS OF THE LEGAL THEORY ON WHICH THE CLAIM IS BASED, AND EVEN IF SAMSUNG HAS BEEN ADVISED OF THE POSSIBILITY OF SUCH DAMAGES.

NOR SHALL RECOVERY OF ANY KIND AGAINST SAMSUNG BE GREATER IN AMOUNT THAN THE PURCHASE PRICE OF THE PRODUCT SOLD BY SAMSUNG AND CAUSING THE ALLEGED DAMAGE.

WITHOUT LIMITING THE FOREGOING, PURCHASER ASSUMES ALL RISK AND LIABILITY FOR LOSS, DAMAGE, OR INJURY TO PURCHASER AND PURCHASER'S PROPERTY AND TO OTHERS AND THEIR PROPERTY ARISING OUT OF THE USE, MISUSE, OR INABILITY TO USE THIS PRODUCT.

THIS LIMITED WARRANTY SHALL NOT EXTEND TO ANYONE OTHER THAN THE ORIGINAL PURCHASER OF THIS PRODUCT, IS NONTRANSFERABLE AND STATES YOUR EXCLUSIVE REMEDY.

Some states do not allow limitations on how long an implied warranty lasts, or the exclusion or limitation of incidental or consequential damages, so the above limitations or exclusions may not apply to you. This warranty gives you specific rights, and you may also have other rights, which vary from state to state.

**To obtain warranty service, please contact SAMSUNG at:  
SAMSUNG ELECTRONICS CANADA, INC. – CONSUMER ELECTRONICS CUSTOMER SERVICE  
55 STANDISH COURT, MISSISSAUGA, ON L5R 4B2  
1-800-SAMSUNG (1-800-726-7864)  
[www.samsung.ca](http://www.samsung.ca)**

# Memo



Contact SAMSUNG WORLD WIDE

If you have any questions or comments relating to Samsung products, please contact the SAMSUNG customer care center.

Samsung Electronics Canada, Inc.

1-800-SAMSUNG (726-7864)

[www.samsung.ca](http://www.samsung.ca)



## Free Manuals Download Website

<http://myh66.com>

<http://usermanuals.us>

<http://www.somanuals.com>

<http://www.4manuals.cc>

<http://www.manual-lib.com>

<http://www.404manual.com>

<http://www.luxmanual.com>

<http://aubethermostatmanual.com>

Golf course search by state

<http://golfingnear.com>

Email search by domain

<http://emailbydomain.com>

Auto manuals search

<http://auto.somanuals.com>

TV manuals search

<http://tv.somanuals.com>