

**SAMSUNG**

# *Instruction Manual*

## **DVD-VR320**



**DVD**  
VIDEO

**VHS**

**Hi-Fi**

[www.samsung.com](http://www.samsung.com)

# Warning

TO REDUCE THE RISK OF ELECTRIC SHOCK, DO NOT REMOVE THE COVER(OR BACK). NO USER-SERVICEABLE PARTS ARE INSIDE. REFER SERVICING TO QUALIFIED SERVICE PERSONNEL.



This symbol indicates "dangerous voltage" inside the product that presents a risk of electric shock or personal injury.



This symbol indicates important instructions accompanying the product.

Do not install this equipment in a confined space such as a bookcase or similar unit.

**WARNING :** To prevent damage which may result in fire or electric shock hazard, do not expose this appliance to rain or moisture.

**CAUTION :** This DVD Recorder & VCR USES AN INVISIBLE LASER BEAM WHICH CAN CAUSE HAZARDOUS RADIATION EXPOSURE IF DIRECTED. BE SURE TO OPERATE RECORDER CORRECTLY AS INSTRUCTED.

## CAUTION

THIS PRODUCT UTILIZES A LASER. USE OF CONTROLS OR ADJUSTMENTS OR PERFORMANCE OF PROCEDURES OTHER THAN THOSE SPECIFIED HEREIN MAY RESULT IN HAZARDOUS RADIATION EXPOSURE. DO NOT OPEN COVERS AND DO NOT REPAIR YOURSELF. REFER SERVICING TO QUALIFIED PERSONNEL.

## CAUTIONS

Caution: To prevent electric shock, match wide blade of plug to wide slot, fully insert.

Attention: Pour éviter les chocs électriques, introduire la lame la plus large de la fiche dans la borne correspondante de la prise et pousser jusqu'au fond.

This product satisfies FCC regulations when shielded cables and connectors are used to connect the unit to other equipment. To prevent electromagnetic interference with electric appliances, such as radios and televisions, use shielded cables and connectors for connections.

## FCC NOTE (for U.S.A):

This equipment has been tested and found to comply with the limits for a Class B digital device, pursuant to

Part 15 of the FCC Rules. These limits are designed to provide reasonable protection against harmful interference in a residential installation. This equipment generates, uses and can radiate radio frequency energy and, if not installed and used in accordance with the instructions, may cause harmful interference to radio communications. However, there is no guarantee that interference will not occur in a particular installation. If this equipment does cause harmful interference to radio or television reception, which can be determined by turning the equipment off and on, the user is encouraged to try to correct the interference by one or more of the following measures:

- Reorient or relocate the receiving antenna.
- Increase the separation between the equipment and receiver.
- Connect the equipment into an outlet on a circuit different from that to which the receiver is connected.
- Consult the dealer or an experienced radio/TV technician for help.



Note

- This unit can be used only where the power supply is AC 120V, 60Hz. It cannot be used elsewhere.
- This DVD Recorder & VCR is designed and manufactured to respond to the Region Management Information. If the Region number of a DVD disc does not correspond to the Region number of this , the DVD Recorder & VCR cannot play the disc.
- This device is protected by U.S. Patent Nos.4,631,603;4,577,216;4,819,098;4,907,093; and 6,516,132. This product incorporates copyright protection technology that is protected by U.S. patents and other intellectual property rights. Use of this copyright protection technology must be authorized by Macrovision, and is intended for home and other limited viewing uses only unless otherwise authorized by Macrovision. Reverse engineering or disassembly is prohibited.
- This product is covered by one or more of the following U.S. patents:  
5,034,830 5,060,200 5,457,669 5,561,649  
5,691,858 5,705,762 5,987,417 6,043,912  
6,222,983 6,272,096 6,377,524 6,377,531  
6,385,587 6,389,569 6,389,570 6,408,408  
6,466,532 6,473,736 6,477,501 6,480,829  
6,556,520 6,556,521 6,556,522 6,594,208  
6,674,697 6,674,957 6,721,493 6,728,474  
6,741,535 09/610381 09/610695

DANGER	- VISIBLE AND INVISIBLE LASER RADIATION WHEN OPEN. AVOID DIRECT EXPOSURE TO BEAM.
CAUTION	- VISIBLE AND INVISIBLE LASER RADIATION WHEN OPEN. AVOID EXPOSURE TO BEAM.
ATTENTION	- RAYONNEMENT LASER VISIBLE ET INVISIBLE EN CAS D'OUVERTURE. EXPOSITION DANGEREUSE AU FAISCEAU.
ADVARSEL	- SYNLIG OG USYNLIG LASERSTRÅLING VED ÅBNING. UNDGÅ UDSÆTTELSE FOR STRÅLING.
VARO !	- AVATTAESSA OLET ALTTIINA NÄKYVÄÄ JA NÄKYMÄTÖN LASERSÄTEILYLLÄ. ÄLÄ KATSO SÄTEESEEN.
WARNING	- SYNLIG OCH OSYNLIG LASERSTRÅLING NÄR DENNA DEL ÄR ÖPPNAD. BETRakta EJ STRÅLEN.
ADVARSEL	- SYNLIG OG USYNLIG LASERSTRÅLING NÄR DEKSEL ÅPNEs. UNNGÅ EKSPONERING FOR STRÅLEN.
VORSICHT	- SICHTBARE UND UNSICHTBARE LASERSTRÄHLUNG, WENN ABDECKUNG GEÖFFNET. NICHT DEM STRAHL AUSSETZEN.
注意	- 打开时有可见及不可见激光辐射。避免激光束照射。
注意	- ここを開くと可視及び不可視のレーザー光が出ます。ビームを直接見たり、触れたりしないでください。

## 2 - English

# Precaution



## Important Safety Instructions

Read these operating instructions carefully before using the unit. Follow all the safety instructions listed below. Keep these operating instructions handy for future reference.

- 1) Read these instructions.
- 2) Keep these instructions.
- 3) Heed all warnings.
- 4) Follow all instructions.
- 5) Do not use this apparatus near water.
- 6) Clean only with dry cloth.
- 7) Do not block any ventilation openings, Install in accordance with the manufacturer's instructions.
- 8) Do not install near any heat sources such as radiators, heat registers, stoves, or other apparatus (including amplifiers) that produce heat.
- 9) Do not defeat the safety purpose of the polarized or grounding-type plug. A polarized plug has two blades with one wider than the other. A grounding type plug has two blades and a third grounding prong. The wide blade or the third prong are provided for your safety. If the provided plug does not fit into your outlet, consult an electrician for replacement of the obsolete outlet.
- 10) Protect the power cord from being walked on or pinched particularly at plugs, convenience receptacles, and the point where they exit from the apparatus.
- 11) Only use attachments/accessories specified by the manufacturer.
- 12) Use only with the cart, stand, tripod, bracket, or table specified by the manufacturer, or sold with the apparatus. When a cart is used, use caution when moving the cart/apparatus combination to avoid injury from tip-over.
- 13) Unplug this apparatus during lightning storms or when unused for long periods of time.
- 14) Refer all servicing to qualified service personnel. Servicing is required when the apparatus has been damaged in any way, such as power-supply cord or plug is damaged, liquid has been spilled or objects have fallen into the apparatus, the apparatus has been exposed to rain or moisture, does not operate normally, or has been dropped.

## Handling Cautions

- Before connecting other components to this recorder, be sure to turn them all off.
- Do not move the recorder while a disc is being played, or the disc may be scratched or broken, and the recorder's internal parts may be damaged.
- Do not put a flower vase filled with water or any small metal objects on the recorder.
- Be careful not to put your hand into the disc tray.
- Do not place anything other than the disc in the disc tray.

- Exterior interference such as lightning and static electricity can affect normal operation of this recorder. If this occurs, turn the DVD Recorder & VCR off and on again with the **POWER** button, or disconnect and then reconnect the AC power cord to the AC power outlet. The recorder will operate normally.
- Be sure to remove the disc and turn off the recorder after use.
- Disconnect the AC power cord from the AC outlet when you don't intend to use the recorder for long periods of time.
- Clean the disc by wiping in a straight line from the inside to the outside of the disc.

## Maintenance of Cabinet

For safety reasons, be sure to disconnect the AC power cord from the AC outlet.

- Do not use benzene, thinner, or other solvents for cleaning.
- Wipe the cabinet with a soft cloth.

## Disc Handling

- Use discs with regular shapes. If an irregular disc (a disc with a special shape) is used, this DVD Recorder & VCR may be damaged.

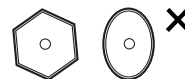

## Holding discs

- Avoid touching the surface of a disc where recording is performed.



## DVD-RAM, DVD-RW and DVD-R

- Clean with an optional DVD-RAM/PD disc cleaner. Do not use cleaners or cloths for CDs to clean DVD-RAM/ DVD-RW/DVD-R discs.



## DVD-Video, CD

- Wipe off dirt or contamination on the disc with a soft cloth.

## Cautions on handling discs

- Do not write on the printed side with a ball-point pen or pencil.
- Do not use record cleaning sprays or antistatic. Also, do not use volatile chemicals, such as benzene or thinner.

- Do not apply labels or stickers to discs. (Do not use discs fixed with exposed tape adhesive or leftover peeled-off stickers.)
- Do not use scratch-proof protectors or covers.
- Do not use discs printed with label printers available on the market.
- Do not load warped or cracked discs.

## Disc Storage

Be careful not to harm the disc because the data on these discs is highly vulnerable to the environment.

- Do not keep under direct sunlight.
- Keep in a cool ventilated area.
- Store vertically.
- Keep in a clean protection jacket.
- If you move your DVD Recorder & VCR suddenly from a cold place to a warm place, condensation may generate on the operating parts and lens and cause abnormal disc playback. If this occurs, remove the disc and wait for one to two hours with the power on before attempting playback.

## Disc Specifications

### DVD-Video

- A digital versatile disc (DVD) can contain up to 135-minutes of images, 8 audio languages and 32 subtitle languages. It is equipped with MPEG-2 picture compression and Dolby 3D surround, allowing you to enjoy vivid and clear theater quality images in the comfort of your own home.
- When switching from the first layer to the second layer of a double-layered DVD Video disc, there may be momentary distortion in the image and sound. This is not a malfunction of the unit.
- Once a DVD-RW/-R recorded in Video Mode is finalized, it becomes DVD-Video.

### Audio CD

- An audio disc on which 44.1kHz PCM Audio is recorded.
- Plays CD-DA format audio CD-R and CD-RW discs. This unit may not be able to play some CD-R or CD-RW discs due to the condition of the recording.

### CD-R/RW

#### MP3 CD-R/RW

- Only CD-R discs with MP3 files recorded with ISO9660 or JOLIET format can be played back
- Only MP3 files with the "mp3" or "MP3" extension can be used.
- For MP3 files recorded with a VBR(Variable Bit Rates), from 32 Kbps to 320 Kbps, the sound may cut in out.
- Playable bitrate range is from 56Kbps to 320Kbps.
- The unit can handle a maximum of 1000 files and folders.

#### JPEG CD-R/RW

- Only JPEG files with the ".jpg", ".JPG" extension can be used.
- The unit can handle a maximum of 1000 files and folders.
- Maximum size of progressive JPEG is 3M pixels.
- MOTION JPEG is not supported.

#### Using CD-R/RW

- Use a 700MB(80 minutes) CD-R/RW disc. If possible, do not use a 800MB(90 minutes) or above disc, as the disc may not play back.
- If the CD-R/RW disc was not recorded as a closed session, you may experience a delay in the early play-back time, and all recorded files may not play.
- Some CD-R/RW discs may not be playable with this unit, depending on the device which was used to burn them. For contents recorded on CD-R/RW media from CDs for your personal use, playability may vary depending on contents and discs.

## DVD-R Disc Playback and Recording

- Once a DVD-R recorded in Video Mode is finalized, it becomes DVD-Video.
- You can record onto the available space on the disc and perform editing functions such as giving titles to discs and programs and erasing programs before finalizing.
- When programming is erased from a DVD-R, that space does not become available. Once an area on a DVD-R is recorded on, that area is no longer available for recording, whether the recording is erased or not.
- It takes about 30 seconds for the unit to complete recording management information after recording finishes.
- This product optimizes the DVD-R for each recording. Optimizing is carried out when you start recording after inserting the disc or turning on the unit. Recording onto the disc may become impossible if optimizing is carried out too many times.
- Playback may be impossible in some cases due to the condition of recording.
- This unit can play back DVD-R discs recorded and finalized with a Samsung DVD video recorder. It may not be able to play some DVD-R discs depending on the disc and the condition of the recording.

## DVD-RW Disc Playback and Recording

- Recording and playback can be performed on DVD-RW discs in both Video and VR Modes.
- Once a DVD-RW recorded in VR Mode is finalized, you cannot perform additional recording.
- Once a DVD-RW recorded in Video Mode is finalized, it becomes DVD-Video.
- In both modes, playback can be performed before and after finalization, but additional recording, deleting and editing can not be performed after finalization.
- If you want to record the disc in VR Mode and then record in V Mode, be sure to execute Format. Be careful when executing Format because all the recorded data may be lost.
- A DVD-RW blank disc is initialized to VR Mode when first initialized.

#### • DVD-RW (VR mode)

- This is a format that is used for recording data on a DVD-RAM or DVD-RW disc. You can record multiple titles, edit, delete, partial delete, create a playlist, etc.
- A disc that is recorded in this mode may not be played by existing DVD players.

#### • DVD-RW (Video mode)

- This is a format that is used for recording data on a DVD-RW or DVD-R disc. The disc can be played by an existing DVD player once it has been finalized.
- If a disc that has been recorded in Video mode by a different manufacturer's recorder but has not been finalized it cannot be played or additionally be recorded by this recorder.

### DVD-RAM Disc Playback and Recording

- For cartridge type DVD-RAM discs, remove the cartridge and use the disc only.
- Ensure that the recording mode is set to VR mode. Otherwise, this product will not be able to play the recording.
- You cannot play a DVD-RAM in most DVD players due to compatibility issues.
- Only DVD-RAM standard Version 2.0 discs can be played in this unit.
- DVD-RAM recorded on this unit may not work with other DVD Players. To determine compatibility with these DVD-RAM discs, refer to the user's manual for the player.

#### COPY PROTECTION

- Many DVD discs are encoded with copy protection. Because of this, you should only connect your DVD Recorder & VCR directly to your TV, not to a VCR. Connecting to a VCR results in a distorted picture from copy-protected DVD discs.
- This product incorporates copyright protection technology that is protected by methods claims of certain U.S. patents and other intellectual property rights owned by Macrovision Corporation and other rights owners. Use of this copyright protection technology must be authorized by Macrovision Corporation, and is intended for home and other limited viewing uses only unless otherwise authorized by Macrovision Corporation. Reverse engineering or disassembly is prohibited.

#### Protection

- Program-protected: See page 66 "Locking a Title"
- Disc-protected: See page 78 "Disc Protection"
- \* DVD-RAM/DVD-RW/DVD-R discs that are incompatible with the DVD-VIDEO format cannot be played with this product.
- \* For more information on DVD recording compatibility, consult your DVD-RAM/DVD-RW/DVD-R manufacturer.
- \* Use of poor quality DVD-RAM/DVD-RW/DVD-R discs may cause following unexpected problems including, without limitation, recording failure, loss of recorded or edited materials or damage to the recorder.

### Do not use the following discs!

- LD, CD-G, CD-I, CD-ROM, DVD-ROM, VCD, DVD+R and DVD+RW discs should not be used in this product.

#### [Note]

Disc types that can be played : CD/CD-R/CD-RW/MP3/JPEG/DVD-Video/DVD-RAM/ DVD-RW/DVD-R. However, if your DVD-RW disc was recorded with another device, it can be played only if it was recorded and finalized in video mode.

- Some commercial discs and DVD discs purchased outside your region may not be playable with this product. When these discs are played, either "No disc." or "Please check the regional code." will be displayed.
- If your DVD-RW disc is an illegal copy or is not in DVD video format, it may also not be playable.

\* We recommend using one of the discs in the table as they have been confirmed to be compatible with this unit. Other discs may not perform correctly.

Media	Brand	Speed
DVD-R	TDK	4x
	Beall	4x
	Sony	4x
	That's	4x
	Mitsubishi	4x
	Maxell	4x
	Panasonic	4x
DVD-RW	TDK	2x
	Maxell	2x
	Optodisc	2x
	JVC	2x
	Mitsubishi	2x
	Radius	2x
	Verbatim	2x
DVD-RAM	Maxell	3x
	Maxell	2x
	Fujifilm	3x
	Panasonic	2x
	TDK	2x
	Panasonic Gold	3x
Panasonic	3x	

Disc	No. of maximum recordings by disc type
DVD-RAM	100,000
DVD-RW	1,000
DVD-R	1

- We take no responsibility and offer no compensation for any recording failure, loss of recorded or edited material and/or damage to the recorder arising from usage of non-recommended discs.

# Contents



## Getting Started

Warning .....	2
Precaution .....	3
Important Safety Instructions .....	3
Handling Cautions .....	3
Maintenance of Cabinet .....	3
Disc Handling .....	3
Disc Storage .....	4
Disc Specifications .....	4
General Features .....	8
Before Reading the User's Manual .....	8
How to use the DVD Recorder & VCR .....	9
Description .....	11
Front Panel .....	11
Front Panel Display .....	11
Rear Panel .....	12
Tour of the Remote Control .....	13

## Connecting & Setting Up

Quick Overview .....	14
Step 1 : Unpacking .....	15
Accessories .....	15
Step 2 : Connecting the Antenna cable .....	15
Method 1 : Antenna + DVD Recorder & VCR + TV : No Cable box .....	15
Method 2 : Antenna +Cable box + DVD Recorder & VCR + TV : Cable box with many scrambled channels .....	15
Method 3 : Antenna + DVD Recorder & VCR + Cable box +TV : Cable box with a few scrambled channels .....	16
Step 3 : Connecting the Video cable .....	16
Method 1 : Connecting to a Video input jack .....	16
Method 2 : Connecting to an S-video input jack .....	17
Method 3 : Connecting to Component video input jacks(Y,P <sub>B</sub> ,P <sub>R</sub> ) .....	17

## 6 - English

Step 4 : Connecting the Audio cable .....	18
Method 1 : Connecting to your TV .....	18
Method 2 : Connecting to a stereo amplifier with analog input jacks .....	18
Method 3: Connecting to an AV amplifier with a digital input jack .....	18
Step 5 : Connecting external devices .....	19
Method 1 : Connecting a VCR, Set-Top Box(STB) or DVD player to the AV IN 1 jacks .....	19
Method 2 : Connecting a Camcorder to the AV IN 2 jacks .....	19
Method 3 : Connecting a Camcorder to the DV IN jack .....	19
Step 6 : Connecting the Power Cord .....	20
Step 7 : Preparing the Remote Control .....	20
Setting the Remote Control .....	21

## System Setup

On-Screen Menu Navigation .....	22
Auto Clock Set .....	23
Manual Clock Set .....	24
Channel Set .....	25
Auto Channel Memory .....	25
Channel Add/Delete .....	26
RF Output Channel .....	26
Setting Up the Language Options .....	27
Setting Up the Audio Options .....	28
Setting Up the Display (Video) Options .....	29
Setting Up the Parental Control .....	30
VCR Setting .....	31
Video Input .....	32
Front Display .....	33
DVD EP Mode Time .....	33
Automatic Chapter Creator .....	34

## Playback

◆ DVD Playback	
Before Playing .....	35
Playing a Disc .....	36
Using the Disc Menu and Title Menu .....	37
Using the Search & Skip Functions .....	37
Slow Motion Play / Step Motion Play .....	38
About ANYKEY .....	38

Repeat Play	.39
Selecting the Subtitle & Audio Language	.41
Changing the Camera Angle	.42
Zooming-In	.42
Using the Bookmarks	.43
Using the Markers	.44
Playing back an Audio CD (CD-DA)	.45
Playing back an MP3 CD	.46
Play Option Mode	.47
To Program Tracks	.47
Playing a picture CD	.48
◆ VCR Playback	
Playing the VCR	.49
Tracking	.49
Special VCR Playback Features	.49
S-VHS Playback	.49
Variable Search System	.50

## Recording

---

◆ DVD Recording	
Before Recording	.51
Recordable discs	.51
Recording Formats	.52
Recording Mode	.52
Unrecordable video	.52
Recording the current channel you are watching	.53
Recording From External Devices	.54
Recording through a DV Input jack	.54
Making a One Touch Recording(OTR)	.55
Making a Timer Recording	.55
Editing the Scheduled Record List	.57
Deleting the Scheduled Record List	.58
◆ VCR Recording	
Basic VCR Recording	.59
Check Remaining Time	.59
Special Recording Features	.60
Copy to DVD or VCR	.61

## Editing

---

Playing the Title List	.63
Basic Editing (Title List)	.65
Renaming(Labeling) a Title	.65
Locking(Protecting) a Title	.66
Deleting a Title	.66
Deleting a Section of a Title	.67
Advanced Editing (Playlist)	.69
Creating a Playlist	.69
Playing Titles in the Playlist	.70
Renaming a Playlist Title	.71
Editing a Scene for the Playlist	.72
Copying a Playlist Title to the VCR	.75
Deleting a Playlist Title from the Playlist	.76
Disc Manager	.77
Editing the Disc Name	.77
Disc Protection	.78
Formatting a Disc	.78
Finalizing a disc	.79
Delete All Title Lists	.80
Unfinalizing a disc (V/VR mode)	.81

## Reference

---

Troubleshooting	.83
Specifications	.86

## General Features

The DVD-VR320 allows you to record and play high quality digital video on DVD-RAM/DVD-RW/DVD-R discs. You can record and edit digital video on DVD-RAM/ DVD-RW/DVD-R discs as if they were VCR tapes.

### High quality digital audio and video recording and playback

Record up to about 16-hour images with a double side 9.4 GB DVD-RAM disc, and up to about 8-hour images with a 4.7 GB DVD-RAM/DVD-RW/DVD-R disc, depending on the recording mode.

### Creating DVD video titles using DVD-RW/DVD-R discs

With the DVD-VR320, VR320, you can create your own DVD video titles on 4.7 GB DVD-RW/DVD-R discs.

### A Variety of Recording Options

Select an appropriate recording mode between XP, SP, LP and EP to meet your recording needs. (See page 52.)

- XP mode - High quality, about 1 hour
- SP mode - Standard quality, about 2 hours
- LP mode - Low quality, about 4 hours
- EP mode - Lower quality, about 6 or 8 hours

### Copying digital camcorder content using DV input jack

Record digital camcorder images onto DVD-RAM/ DVD-RW/DVD-R discs or video tape using the DV input jack (IEEE 1394-4pin). (See page 19.)

### High quality progressive scan

Progressive scanning provides high resolution and flicker free video. The 10-bit 54-MHz DAC, 2D Y/C Separating circuitry and Time Base Corrector processor technology provide you with the highest image playback and recording quality. (See page 17.)

Component progressive scan output video is available in both DVD and VCR modes.











### A variety of functions with easy-to-use user interface

Integrated menu system and messaging functionality allow you to perform the desired operations easily and conveniently. With a DVD-RAM/DVD-RW(VR mode) disc, you can edit recorded images, create playlist, and edit video in specific sequence according to your needs.

## Before Reading the User's Manual

Make sure to check the following terms before reading the user's manual.

### Icons that will be used in manual

Icon	Term	Definition
	DVD	This involves a function available in DVD or DVD-R/DVD-RW discs that have been recorded and finalized in Video Mode.
	RAM	This involves a function available in DVD-RAM.
	RW	This involves a function available in DVD-RW.
	R	This involves a function available in DVD-R.
	CD	This involves a function available in a data CD (CD-R or CD-RW).
	JPEG	This involves a function available in a data picture CD (CD-R or CD-RW).
	MP3	This involves a function available in a data CD (CD-R or CD-RW) on which MP3 is recorded.
	Caution	This involves a case where a function does not operate or settings may be cancelled.
	NOTE	This involves tips or instructions on the page that help each function operate.
	One-Touch button	A function that can be operated by using only one button.
	ANYKEY button	A function that can be operated by using ANYKEY button.

### About the use of this user's manual

- 1) Be sure to be familiar with Safety Instructions before using this product. (See pages 2-5)
- 2) If a problem occurs, check the Troubleshooting. (See pages 83-85)

### Copyright

©2005 Samsung Electronics Co.  
All rights reserved; No part or whole of this user's manual may be reproduced or copied without the prior written permission of Samsung Electronics Co.



# How to use the DVD Recorder & VCR

## Step 1 Select the disc type

This unit can record on the following types of discs. If you want to repeatedly record on the same disc or you want to edit the disc after recording, select a rewritable DVD-RW or DVD-RAM type disc. If you want to save a recording without any changes, choose a non-rewritable DVD-R.



## Step 2 Format the disc to start recording

Unlike a VCR, the recorder automatically starts formatting when an unused disc is inserted. This is required for the preparation of recording on a disc.

### Using a DVD-RAM

This type of disc can be formatted in DVD-Video Recording format (VR mode). You can edit recorded images and create a playlist in a specific sequence according to your requirements.

### Using a DVD-RW

This type of disc can be formatted in either DVD-Video format (Video mode) or DVD-Video Recording format (VR mode). For an unused disc, a message that asks whether to format in VR Mode or not is displayed. You can play a video mode disc on various DVD components. A VR mode disc allows more varied editing.

### Using a DVD-R

This type of disc can be formatted in DVD Video format. After formatting is complete, you can record on the disc. You can play this type of disc on various DVD components only when they have been finalized.



Note

- You can only use either the VR or Video mode on a DVD-RW, but not both at the same time.
- You can change the DVD-RW format to another format by reinitializing. It should be noted that the disc's data will be lost when changing formats.

## Step 3 Recording

There are two different recording methods: Direct Recording and Timer Recording. Timer recording is classified as a Date : Once, Daily or Weekly. Recording mode : XP (high quality mode), SP (standard quality mode), LP (long recording mode), and EP (extended mode).

## Step 4 Playing

You can select the title you want to play in a displayed menu and then immediately start playback. A DVD consists of sections called titles, and sub sections called chapters.

During recording, a title is created between two points where you start and stop recording. Chapters will be created automatically when you finalize recording on DVD-R / DVD-RW discs in Video mode with the Chapter Creator set to On. The chapter's length (interval between chapters) varies according to the recording mode.

## Step 5 Editing a recorded disc

Editing on discs is easier than conventional video tapes. The recorder supports many different edit functions, possible only with DVDs.

With a simple and easy edit menu, you can operate various edit functions, such as delete, copy, rename, lock, etc., on a recorded title.

### Creating a playlist (DVD-RAM/RW in VR mode)

With this recorder, you can create a new playlist on the same disc and edit it without the change of the original recording.

**Step 6****Finalizing & Playing on other DVD components**

To play your DVD on other DVD components, finalizing may be necessary. First, finish all editing and recording operations, then finalize the disc.

**When using a DVD-RW disc in VR Mode**

Although finalizing is generally unnecessary when playing the disc on a VR Mode compatible component, a finalized disc should be used for playback.

**When using a DVD-RW disc in Video Mode**

The disc should be finalized first to enable playback on anything other than this recorder. No more editing or recording can be made on the disc once it has been finalized.

**When using a DVD-R disc**

You should finalize the disc to play it on a component other than this recorder. You cannot edit or record on the disc once it has been finalized.

# Description

## Front Panel

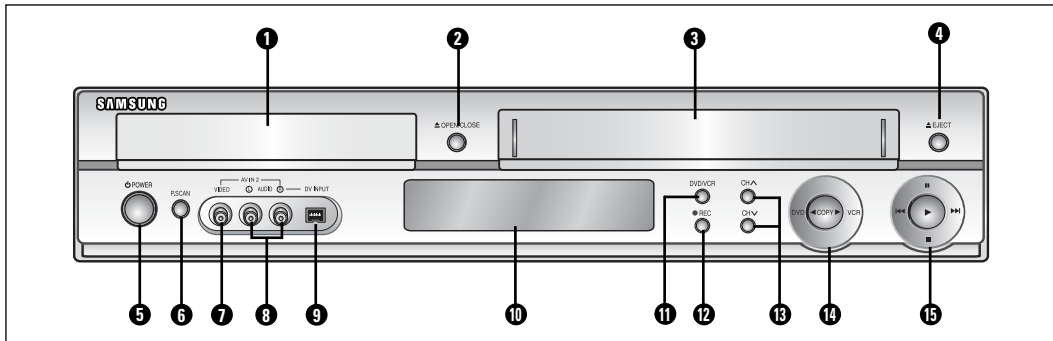

1. DVD DECK
2. DVD OPEN/CLOSE BUTTON
3. VCR DECK
4. VCR EJECT BUTTON
5. POWER BUTTON
6. P.SCAN BUTTON
7. VIDEO INPUT JACK (AV IN 1)
8. AUDIO L, R INPUT JACKS (AV IN 2)
9. DV INPUT JACK
10. FRONT PANEL DISPLAY
11. DVD/VCR SELECT BUTTON
12. RECORD BUTTON
13. CHANNEL  $\wedge$  /  $\vee$  BUTTONS
14. COPY BUTTON
15. PLAY/STILL, REW/SKIP, F.F/SKIP, STOP, BUTTONS

## Front Panel Display

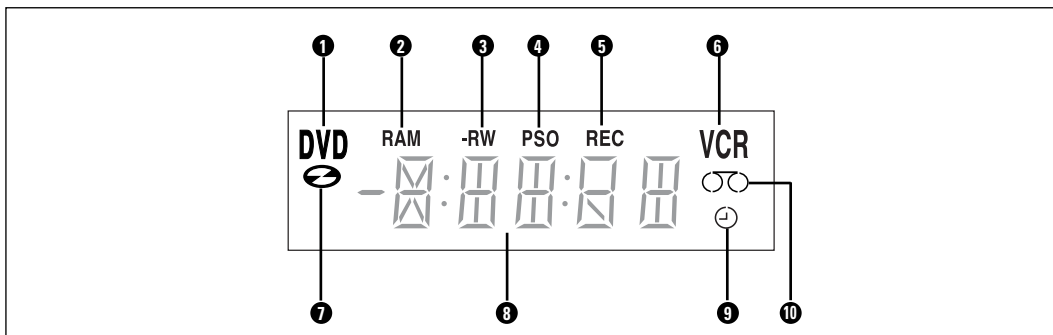

1. DVD is activated.
2. DVD-RAM is activated.
3. DVD-R or DVD-RW is activated.
4. Progressive Scan mode is activated.
5. Record function is activated.
6. VCR is activated.
7. DVD or CD media is loaded.
8. The time, counter position or current deck status is indicated.
9. When you set a Timer recording, this indicator is it.
10. VHS Videotape is loaded.

## Rear Panel

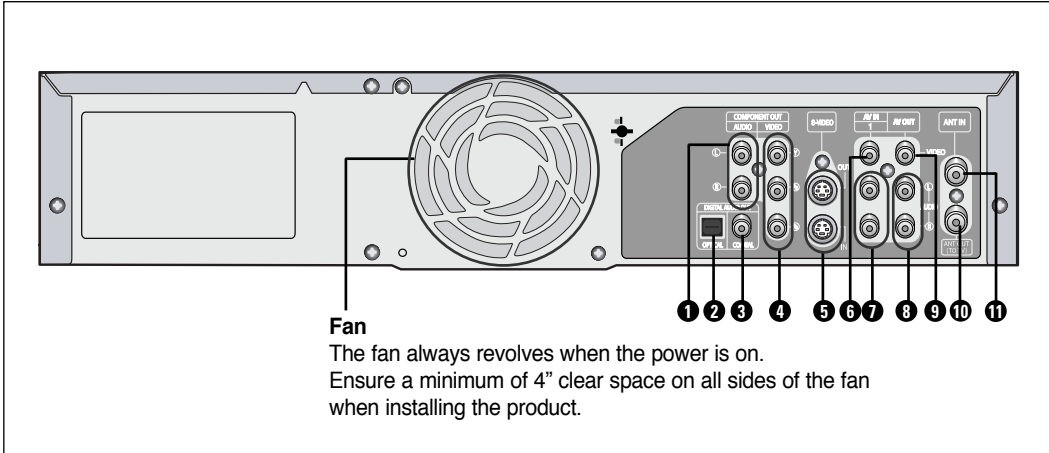

- |  |                                     |
|--|-------------------------------------|
| 1. AUDIO L, R OUT JACKS<br>(COMPONENT OUT) | 6. VIDEO INPUT JACK (AV IN 1)       |
| 2. DIGITAL AUDIO OUT JACK (OPTICAL)        | 7. AUDIO L, R INPUT JACKS (AV IN 1) |
| 3. DIGITAL AUDIO OUT JACK (COAXIAL)        | 8. AUDIO L, R OUT JACKS (AV OUT)    |
| 4. VIDEO OUT JACKS (COMPONENT OUT)         | 9. VIDEO OUT JACK (AV OUT)          |
| 5. S-VIDEO IN/OUT JACKS                    | 10. ANT OUT (TO TV) JACK            |
|  | 11. ANT IN JACK                     |

## Tour of the Remote Control

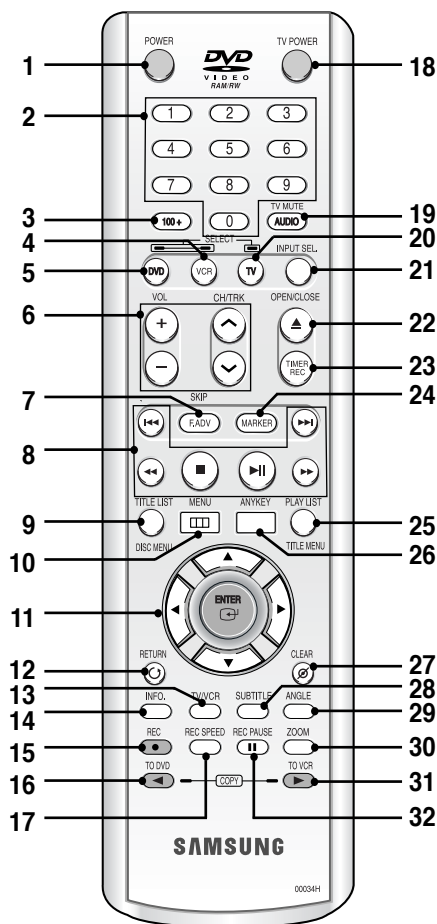

- 1. POWER Button**
- 2. NUMBER Button**
- 3. 100+ Button**  
Press this to select channel 100 or higher.
- 4. VCR Button**  
Press this when you use a VCR.
- 5. DVD Button**  
Press this when you use a DVD.
- 6. TV Control Buttons**
  - **VOLUME Button**  
TV volume adjustment
  - **CHANNEL Button**  
Press this to select a TV channel.
  - **TRK Button**  
Press this to remove the white line.
- 7. F.ADV/SKIP Button**
- 8. Playback-related Buttons**  
Forward/Rewind, Search, Skip, Stop, Play/Pause
- 9. TITLE LIST(DISC MENU) Button**  
Press this to enter the TITLE list/Disc menu.
- 10. MENU Button**  
Press this to bring up the DVD Recorder & VCR's setup menu.
- 11. ENTER/DIRECTION Buttons**  
(UP/DOWN or LEFT/RIGHT Buttons)  
This button functions as a toggle switch.

- 12. RETURN Button**  
Returns to a previous menu.
- 13. TV/VCR Button**
- 14. INFO Button**  
Press this to display current setting or disc status.
- 15. REC Button**  
Press this to make a recording on VCR, DVD-RAM/-RW/-R discs.
- 16. DVD COPY Button**  
Press this when you copy from the VCR to the DVD.
- 17. REC SPEED Button**  
Use this to set the desired recording time and picture quality.
- 18. TV POWER Button**
- 19. AUDIO/TV MUTE Button**  
Press this to access various audio functions. This operates as sound mute. (TV mode)
- 20. TV Button**  
Press this to operate TV.
- 21. INPUT SEL. Button**  
Press this to select AV input signal in external input mode. (Tuner, AV input, DV input)
- 22. OPEN/CLOSE Button**  
Press this to open and close the disc tray.
- 23. TIMER REC Button**  
Press this when you use Timer Recording.
- 24. MARKER Button**  
Press this to bookmark or mark a position while playing a disc.
- 25. PLAY LIST(TITLE MENU) Button**  
Press this to enter the Edit playlist/Title menu.
- 26. ANYKEY Button**  
Press this to view the status of the disc that is being played.
- 27. CLEAR Button**
- 28. SUBTITLE Button**  
Press this to switch the DVD's subtitle language.
- 29. ANGLE Button**  
Press this to access various camera angles on a disc (if the disc contains multiple camera angles).
- 30. ZOOM Button**  
Zooms in on screen.
- 31. VCR COPY Button**  
Press this when you copy DVD to VCR.
- 32. REC PAUSE Button**  
Press this to pause during recording.

### Key Lock Function

If you do not want others to operate the DVD Recorder & VCR (for example if you have programmed a timer recording) you can set the equipment to lock out all button controls.

- Press and hold the **INFO** button on the remote control for 5 seconds.  
The display will show "SAFE" when the feature is activated.
- To resume normal mode, press and hold the **INFO** button again for 5 seconds.  
"SAFE" will disappear and the DVD Recorder & VCR will operate normally.

# Connecting & Setting Up

Quick Overview .....	14
Step 1 : Unpacking .....	15
Step 2 : Connecting the Antenna cable .....	15
Step 3 : Connecting the Video cable .....	16
Step 4 : Connecting the Audio cable .....	18
Step 5 : Connecting External Devices .....	19
Step 6 : Connecting the Power Cord .....	20
Step 7 : Preparing the Remote Control .....	20

## Quick Overview

A Quick overview presented in this guide will give you enough information to start using the recorder.

### Step 1 : Unpacking



### Step 2 : Connecting the Antenna Cable



### Step 3 : Connecting the Video Cable



### Step 4 : Connecting the Audio Cable



### Step 5 : Connecting External Devices



### Step 6 : Connecting the Power Cord



### Step 7 : Preparing the Remote Control

- **Note to CATV system installer :** This reminder is to call CATV system installer's attention to Article 820-40 of the National Electrical Code (Section 54 of Canadian Electrical Code, Part I), that provides guidelines for proper grounding and, in particular, specifies that the cable ground shall be connected to the grounding system of the building as close to the point of cable title as practical.

# Step 1: Unpacking

## Accessories

Check for the supplied accessories below.

- Video/Audio Cable (AC39-00073A)
- RF Cable for TV (AC39-42001J)
- Remote Control (AK59-00034H)
- Batteries for Remote Control (AAA Size) (AC43-12002H)
- User's Manual
- Quick Guide

# Step 2: Connecting the Antenna Cable

There are several ways to connect your DVD Recorder & VCR. Select one of the following antenna connections that best suits you below.

- **Method 1** : Antenna + DVD Recorder & VCR + TV : No Cable box
- **Method 2** : Antenna +Cable box + DVD Recorder & VCR + TV : Cable box with many scrambled channels
- **Method 3** : Antenna + DVD Recorder & VCR + Cable box + TV : Cable box with a few scrambled channels



Note

- If you are using an off-air antenna that has 300-ohm twin flat leads, use an external antenna connector (300-75 ohm adaptor : not supplied) to connect the antenna to the DVD Recorder & VCR.

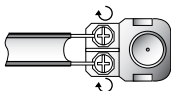

- If you have two separate antennas (one VHF and the other UHF), use a UHF/VHF combiner-adaptor (available at most electronics shops) to connect the antenna to the DVD Recorder & VCR.

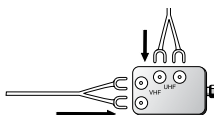

## Method1 : Antenna + DVD Recorder & VCR + TV : No Cable box

You can record non-scrambled channels by selecting the channel on the DVD Recorder & VCR. Also use this Method if you watch channels without a cable box.

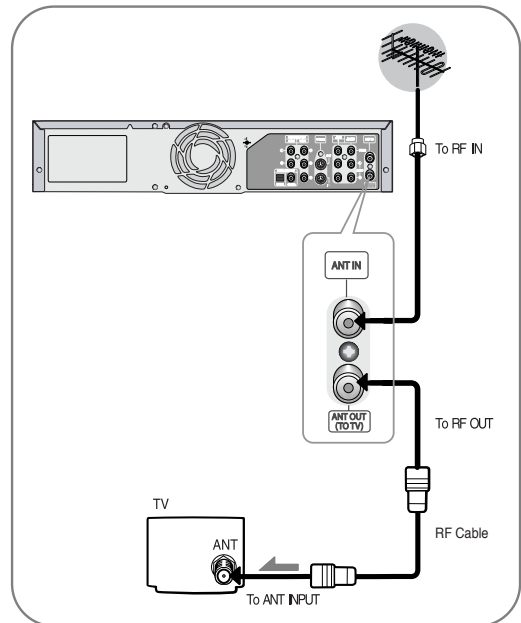

## Method 2 : Antenna +Cable box + DVD Recorder & VCR + TV : Cable box with many scrambled channels

You can record channels by selecting the channel on the cable box. You cannot record one channel while watching another channel. Be sure that the cable box is turned on.

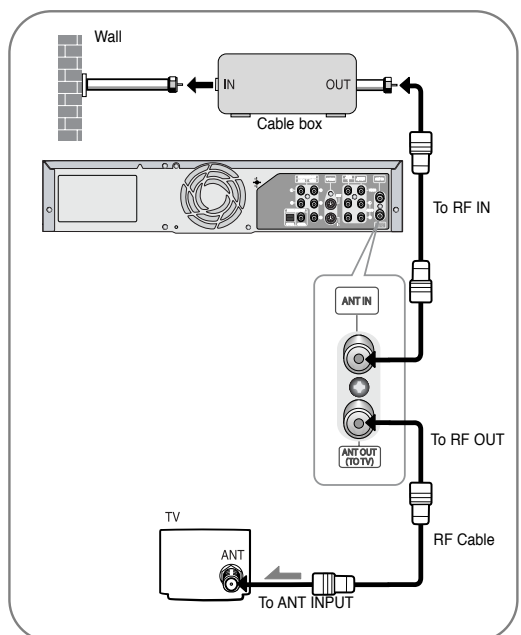

### Method 3 : Antenna + DVD Recorder & VCR + Cable box +TV : Cable box with a few scrambled channels

You can record non-scrambled channels by selecting the channel on the cable box. You cannot record scrambled channels that require a cable box.

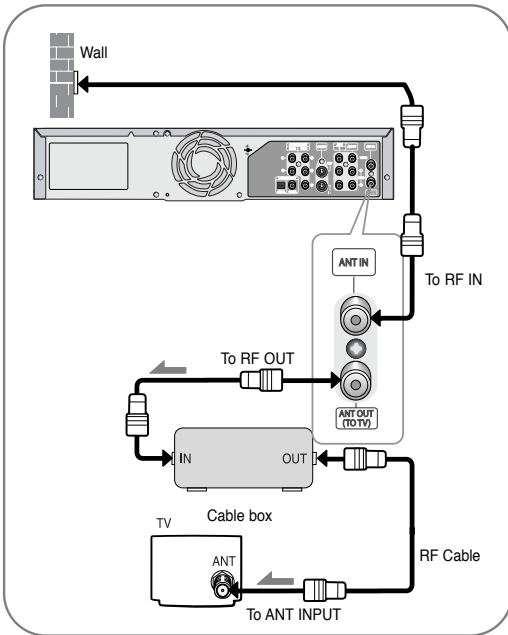

## Step 3: Connecting the Video Cable

There are several ways to connect your DVD Recorder & VCR. Select one of the following video connecting methods that best suits you below.

- **Method 1** : Connecting to a Video input jack
- **Method 2** : Connecting to an S-video input jack
- **Method 3** : Connecting to Component video input jacks (Y, PB, PR)

### S-Video, Component video and Progressive Output Modes

- S-Video and Component video output are available only if your TV supports S-Video input or Component video input, respectively. If S-Video or Component video output does not work, check the TV connections and the TV input selection settings.

- Compared to standard interlaced video, progressive scan doubles the amount of video lines fed to your TV, resulting in a more stable, flicker-free, and clear image than interlaced video. The progressive scan video output jack is used in progressive output mode. This is only available with TVs that support progressive scan.
- Consumers should note that not all high definition television sets are fully compatible with this product and may cause artifacts to be displayed in the picture. If you experience 480 progressive scan picture problems, it is recommended that you switch the connection to the 'standard definition' output. If there are questions regarding TV set compatibility with this model, please contact our customer service center at 1-800-SAMSUNG.

### Method 1 : Connecting to a video input jack

Connect a video(yellow) cable between the VIDEO OUT jack (AV OUT) on DVD Recorder & VCR and VIDEO (yellow) IN jack on the TV(or AV amplifier).

- You will enjoy regular quality images.
- Connect audio cables (white and red) between the AUDIO L, R OUT Jacks (AV OUT) on the DVD Recorder & VCR and AUDIO IN jacks on TV (or AV amplifier).

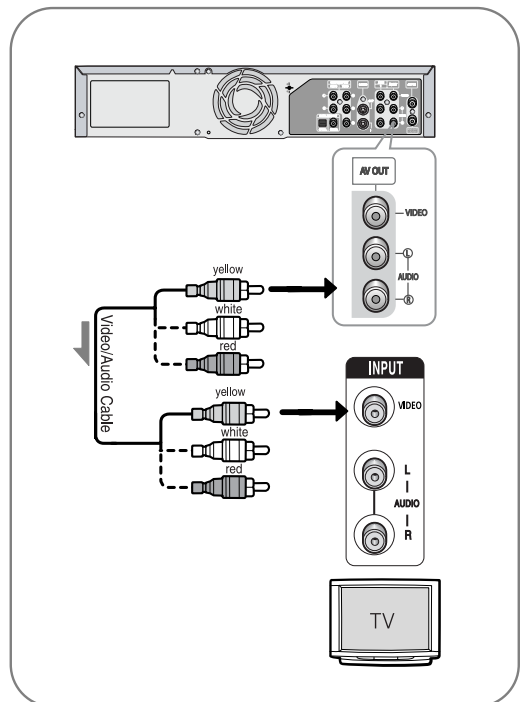



## Method 2 : Connecting to an S-video input jack

Connect an S-video cable(not included) between the S-VIDEO OUT jack on DVD Recorder & VCR and S-VIDEO IN jack on your TV (or AV amplifier).

- You will enjoy high quality images. S-Video separates the picture element into black and white (Y) and color (C) signals to present clearer images than regular video input mode.
- Connect audio cables(white and red) between the AUDIO L, R OUT Jacks (AV OUT) on the DVD Recorder & VCR and AUDIO IN jacks on TV(or AV amplifier). (See pages 18 to 19)

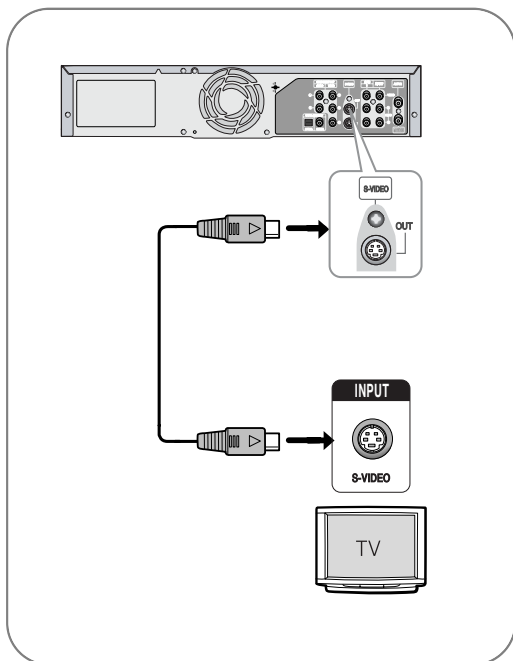

## Method 3 : Connecting to Component video input jacks(Y,PB,PR)

Your TV must support progressive scan input to allow you to watch progressive scan component video output.

1. Connect Component video cables(not included) between the VIDEO OUT jacks (COMPONENT OUT) on DVD Recorder & VCR and COMPONENT VIDEO IN jacks on your TV (or AV amplifier).
2. Press the **P.SCAN** button on the front panel while the unit is in Stop mode. The message [Press "Yes" to confirm Progressive scan mode. Otherwise press "No".] will be displayed. Press the ◀▶ buttons to select Yes, and then press the **ENTER** button. Make sure that the disc has stopped completely before changing the mode.

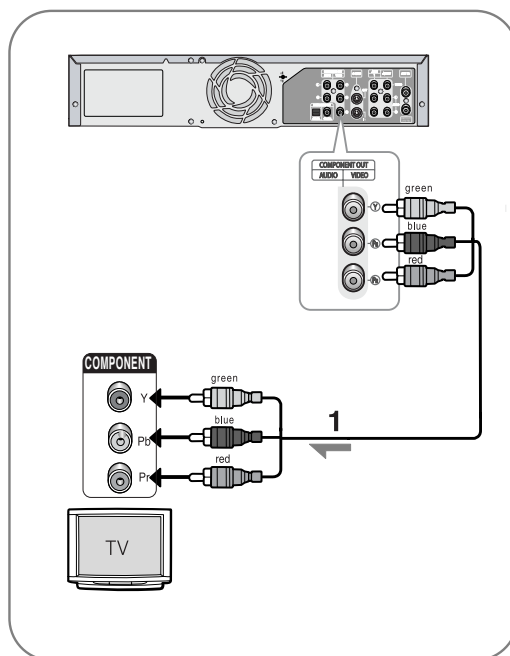

- You will enjoy high quality accurate color reproduction images. Component video separates the picture element into black and White(Y), blue(P<sub>B</sub>), red(P<sub>R</sub>) signals to present most clear and clean images.



Note

- Make sure that the color coded connections match. That is, the Y, P<sub>B</sub> and P<sub>R</sub> component output jacks of your DVD Recorder & VCR should be connected to the exact corresponding component input jacks on your TV. Otherwise, red or blue images will be displayed on the TV screen.
- Make sure that the left and right audio output jacks of your DVD Recorder & VCR are connected to the left and right audio input jacks of your TV, respectively.(page 18)

# Step 4 : Connecting the Audio Cable

There are several ways to connect your DVD Recorder & VCR. Select the audio connection that best suits you below.

- **Method 1** : Connecting to your TV
- **Method 2** : Connecting to a stereo amplifier (analog audio out)
- **Method 3** : Connecting to an AV amplifier with a digital input jack.

Manufactured under license from Dolby Laboratories. "Dolby" and the double-D symbol are trademarks of Dolby Laboratories.

"DTS" and "DTS Digital Out" are trademarks of Digital Theater Systems, Inc.

## Method 1 : Connecting to your TV

If your TV has audio input jacks, use this connection.

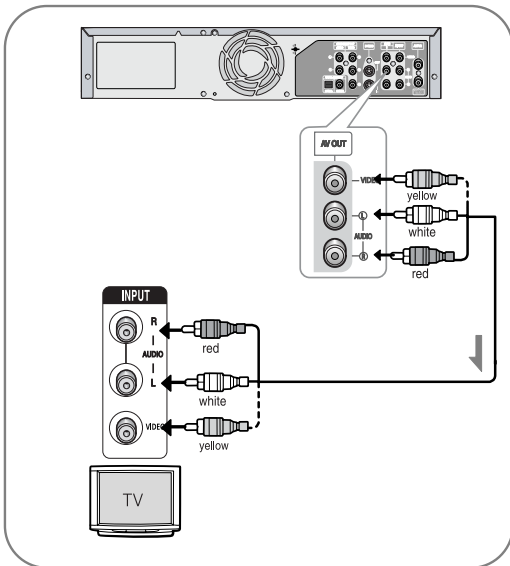

## Method 2 : Connecting to a stereo amplifier with analog input jacks

If your stereo amplifier only has audio input jacks (L and R), use the analog audio out jacks on the DVD Recorder & VCR.

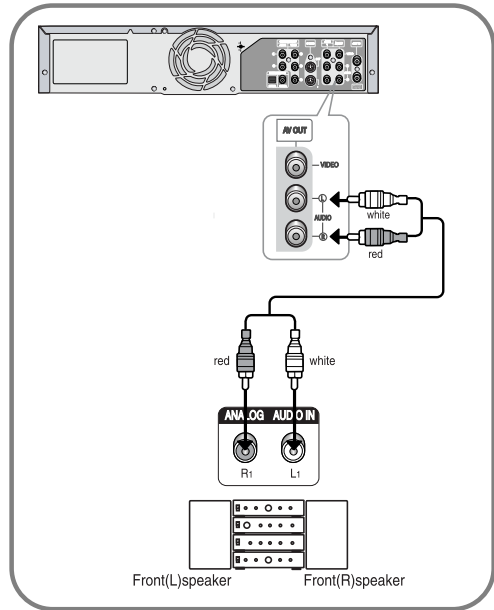

## Method 3 : Connecting to an AV amplifier with the digital input jack

If your AV amplifier has a Dolby Digital or DTS decoder and a digital input jack, use this connection. To enjoy Dolby Digital or DTS sound, you will need to set up the audio settings. (See page 28)

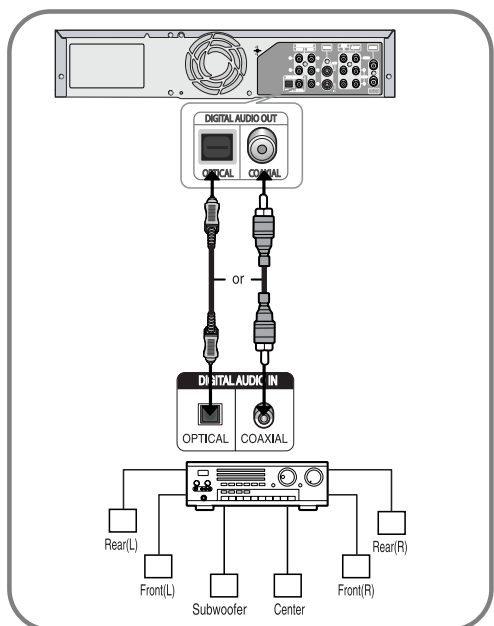

## Step 5 : Connecting External Devices

This allows you to connect your DVD Recorder & VCR to other external devices and view or record their outputs.

- **Method 1** : Connecting a VCR, Set-Top Box(STB) or DVD player to the AUDIO/VIDEO AV IN 1 jacks.
- **Method 2** : Connecting a Camcorder to the AV IN 2 jacks.
- **Method 3** : Connecting a Camcorder to the DV IN jack.

### Method 1 : Connecting a VCR, Settop Box(STB) or DVD player to the AUDIO/VIDEO AV IN 1 jacks

Connecting a VCR or external device to AV IN 1 jacks of the DVD Recorder & VCR.

You can record from connected equipment (VCR, STB or DVD).

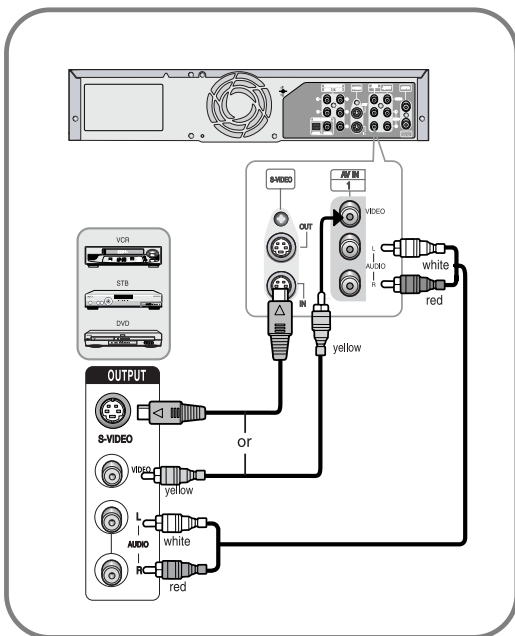

- You can also use the AV IN 2 jacks on the front panel of the DVD Recorder & VCR.
- When the S-Video jack and Video jack are both connected, the S-Video jack will have priority. Line Selection will be automatically done.
- Copy protected content cannot be recorded.

### Method 2 : Connecting a Camcorder to the AV IN 2 jacks

You can use the AV IN 2 jacks on the front panel of the DVD Recorder & VCR. You can record from connected as a camcorder.

When an input source is inserted into AV IN 2 while viewing TV, the input will be switched to AV IN 2 automatically.

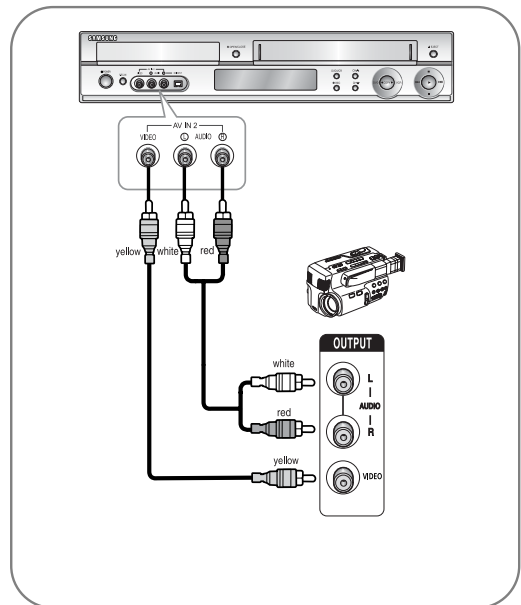

### Method 3 : Connecting a Camcorder to the DV IN jack

If your camcorder has a DV output jack, connect it to the DV input jack of your DVD Recorder & VCR.

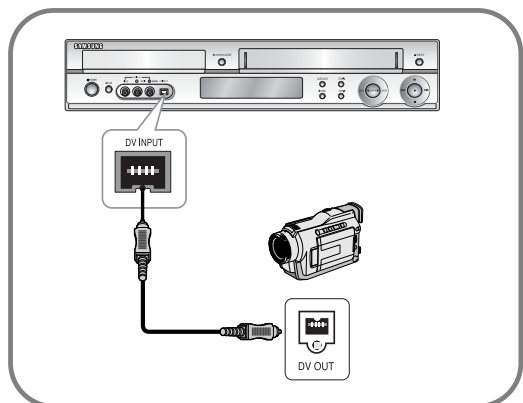

## Step 6 : Connecting the Power Cord

After all connections are complete, plug the power cord in the wall outlet.

**“Auto” appears in the front panel display. This means that the current time is being set automatically through the antenna under connection(Auto Program). The setup may take several minutes.**

When the DVD Recorder & VCR operates normally, the current time is automatically set and displayed in the front panel display.

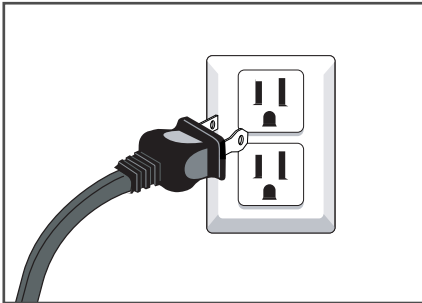

## Step 7 : Preparing the Remote Control

### Install Batteries in the Remote Control

- Open the battery cover on the back of the remote control.
- Insert two AAA batteries. Make sure that the polarities (+ and -) are aligned correctly.
- Replace the battery cover.

### If the remote control does not operate properly:

- Check the polarity + - of the batteries (Dry-Cell)
- Check if the batteries are drained.
- Check if the remote sensor is blocked by obstacles.
- Check if there is any fluorescent lighting nearby.

Dispose of batteries according to local environmental regulations. Do not put them in the household trash.

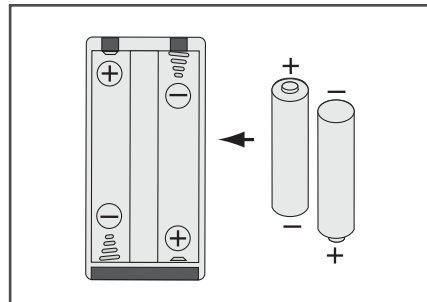

## Setting the Remote Control

You can control part of another manufacturer's TV functions with this remote control.

- Control function buttons involve : TV POWER, CH/TRK (▲/▼), VOL +/-, Direct number buttons, TV MUTE, INPUT SEL.



To determine whether your television is compatible, follow the instructions below.

- Switch your television on.
- Point the remote control towards the television.
- Press the TV button and enter the two-figure code corresponding to the brand of your television, by pressing the appropriate number button.

Brand	Codes	Brand	Codes
SAMSUNG	01,14,15,23,31	NEWSAN	27
DAEWOO	19	NOBLEX	25
EMERSON	21	PANASONIC	12,24
GRADIENTE	30	RCA	07,29
HITACHI	10	SANYO	05,20
JVC	11	SHARP	02,16,22
LG	06,08,18	SONY	03
LOEWE	28	TELEFUNKEN	26
MAGNAVOX	04	TOSHIBA	09
MITSUBISHI	13	ZENITH	17

Result: If your television is compatible with the remote control, it will switch off.

It is now programmed to operate with the remote control.



Note

- If several codes are indicated for your television brand, try each one in turn until you find one that works. If you replace the remote control's batteries, you must set the brand code again.

You can then control the television using the following buttons.

Button	Function
TV POWER	Used to switch the television on and off.
INPUT SEL.	Used to select an external source.
VOL +/-	Used to adjust the volume of the television.
CH/TRK (▲/▼)	Used to select the desired channel.
TV MUTE	Used to toggle the sound on and off.
0~9	Used to input number directly.
100+	Used to select channels over 100.



Note

- The various functions may not necessarily work on all televisions. If you encounter problems, operate the television directly.

# System Setup

On-Screen Menu Navigation.....	22
Auto Clock Set .....	23
Manual Clock Set .....	24
Channel Set .....	25
Auto Channel Memory.....	25
Channel Add/Delete .....	26
RF Output Channel.....	26
Setting Up the Language Options .....	27
Setting Up the Audio Options .....	28
Setting Up the Display (Video) Options .....	29
Setting Up the Parental Control.....	30
VCR Setting .....	31
Video Input .....	32
Front Display .....	33
DVD EP Mode Time .....	33
Automatic Chapter Creator.....	34

## On-Screen Menu Navigation

The on-screen menus allow you to enable or disable various functions on your DVD Recorder & VCR. Use the following buttons to open and navigate through the on-screen menus.

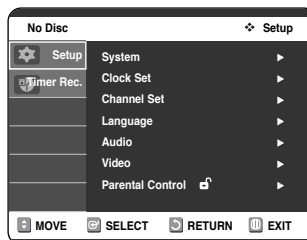

### 1 MENU Button

Press this button on the remote control to open the on-screen **MENU**. Press again to exit the on-screen **MENU**.

### 2 ▲▼,◀▶ Buttons

Press these buttons on the remote control to move the selection bar ▲▼,◀▶ to cycle through the menu options.

### 3 ENTER Button

Press this button on the remote control to confirm any new settings.

### 4 RETURN Button

Press this button on the remote control to return to the previous **MENU** screen displayed or to exit the on-screen **MENU**.

# Auto Clock Set

This menu is used to set the current time. You need to set the time to use timer recording.



Note

- You must have the antenna connected to set the Auto Clock. See pages 15~16 for Antenna Connections.
- The Clock will be automatically set when you turn off the recorder.

- 1 With the unit in Stop mode/No Disc mode, press the **MENU** button.

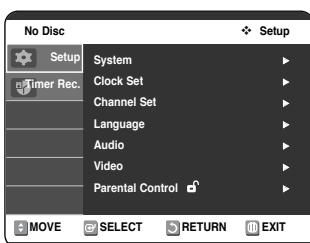

- 2 Press the **▲▼** buttons to select **Setup**, then press the **ENTER** or **▶** button.

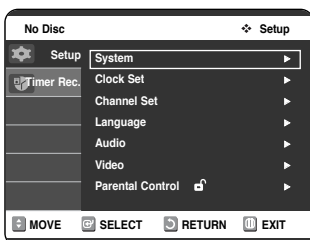

- 3 Press the **▲▼** buttons to select **Clock Set**, then press the **ENTER** or **▶** button.

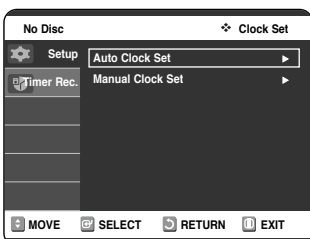

- 4 Press the **▲▼** buttons to select **Auto Clock Set**, then press the **ENTER** or **▶** button.

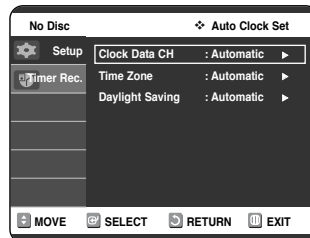

Note

- If your clock is set to the wrong time zone or daylight saving, you can adjust these settings without turning off the Auto Clock Set function.

- 5 Press the **▲▼** buttons to select the sub menu (Clock Data CH, Time Zone or Daylight Saving), then press the **ENTER** or **▶** button.

## Clock Data CH

Press the **▲▼** buttons to select a channel that carries a time signal, then press the **ENTER** button. Select Auto to set the channel automatically.

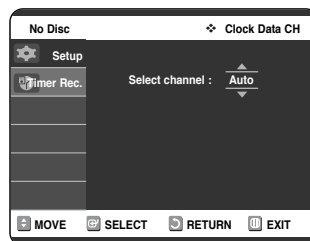

## Time Zone

Press the **▲▼** buttons to select the time zone of your area, then press the **ENTER** or **▶** button. Select Automatic to set the time zone automatically.

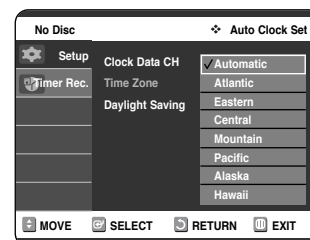

## Daylight Saving

Press the ▲▼ buttons to select **Automatic**, **Yes** or **No**, then press the **ENTER** or ► button. Select Automatic to set the daylight saving automatically.

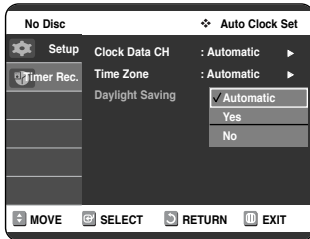

## Manual Clock Set

If Auto Setup fails to set the DVD Recorder & VCR's internal clock by locating a local TV station, follow these steps to set the date and time manually.



Note

For accurate Timer Recording, your DVD Recorder & VCR's internal clock must be set correctly.

- 1 With the unit in Stop mode/No Disc mode, press the **MENU** button.

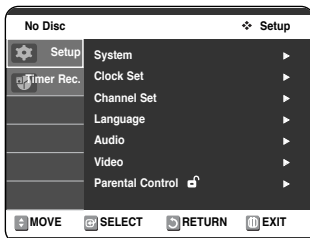

- 2 Press the ▲▼ buttons to select **Setup**, then press the **ENTER** or ► button.

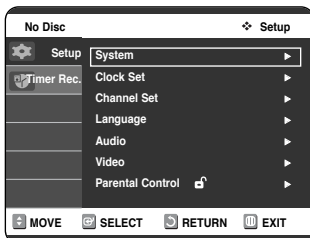

- 3 Press the ▲▼ buttons to select **Clock Set**, then press the **ENTER** or ► button.

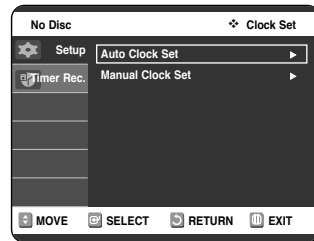

- 4 Press the ▲▼ buttons to select **Manual Clock Set**, then press the **ENTER** or ► button.

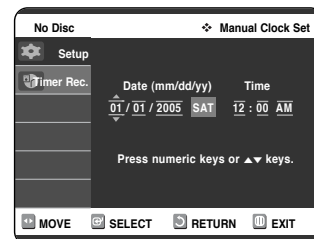

- 5 Press the ▲▼◀▶ buttons to select the Current Date and Current Time, then press the **ENTER** button. When the current time is stored in memory and then the set is powered off, the current time will appear in the front panel display.

▲▼ : Sets the value

You can set the value using the number (0~9) buttons.

◀▶ : Moves to items



# Channel Set

This feature allows you to manually set the DVD Recorder & VCR's tuner band to Antenna or Cable, whichever you connected to the Antenna In jack during initial setup.

- Use this setting only if Auto Setup detected the incorrect tuner band, i.e. channels are coming in on the wrong channel numbers.

- 1 With the unit in Stop mode/No Disc mode, press the **MENU** button.

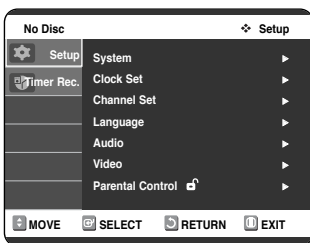

- 2 Press the **▲▼** buttons to select **Setup**, then press the **ENTER** or **▶** button.

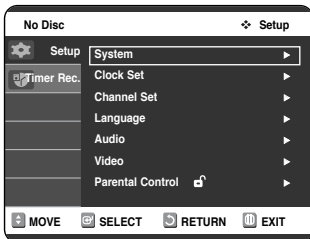

- 3 Press the **▲▼** buttons to select **Channel Set**, then press **ENTER** or **▶** button.

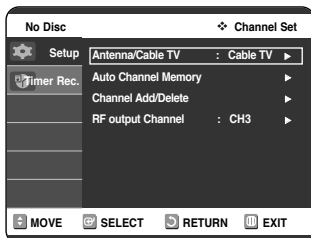

- 4 Press the **▲▼** buttons to select **Antenna/Cable TV**, then press the **ENTER** or **▶** button.

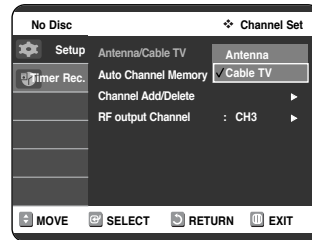

Select the Antenna/Cable TV(Signal Source) that matches the antenna connection you selected on pages 15~16(method1, 2 and 3).

- Antenna - Select if the DVD Recorder & VCR is connected to an indoor or outdoor VHF/UHF Antenna(method1 and 3).
- Cable TV - Select if the DVD Recorder & VCR is connected to Cable TV(method 2).

# Auto Channel Memory

Auto Channel Memory will automatically seek and store all active channels in your area.

- 1 With the unit in Stop mode/No Disc mode, press the **MENU** button.

- 2 Press the **▲▼** buttons to select **Setup**, then press the **ENTER** or **▶** button.

- 3 Press the **▲▼** buttons to select **Channel Set**, then press the **ENTER** or **▶** button.

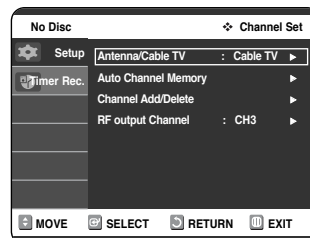

- 4** Press the ▲▼ buttons to select **Auto Channel Memory**, then press the **ENTER** or ► button.

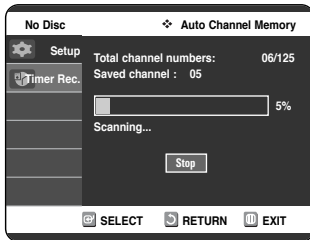

- The DVD Recorder & VCR will automatically search for all available channels in the selected tuner band. This procedure may take a few minutes to complete.
- When finished, the lowest channel found will be displayed.
- Press **ENTER** button to stop or cancel scanning.

## Channel Add/Delete

Use this feature if Auto Channel Memory missed a channel that you would like to add and delete a channel you wish to remove.

- 1** With the unit in Stop mode/No Disc mode, press the **MENU** button.
- 2** Press the ▲▼ buttons to select **Setup**, then press the **ENTER** or ► button.
- 3** Press the ▲▼ buttons to select **Channel Set**, then press the **ENTER** or ► button.

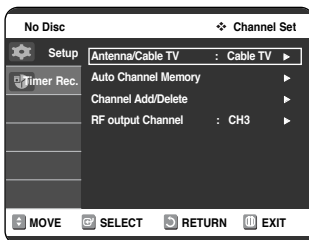

- 4** Press the ▲▼ buttons to select **Channel Add/Delete**, then press the **ENTER** or ► button.

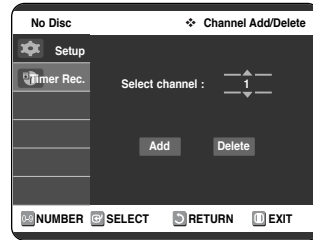

- 5** Press the ▲▼ or number buttons to select the channels you want to add or delete on the Select channel screen. Then, press the **ENTER** button.
- Using ▲▼ buttons for channel selection allows the user to add/delete one channel at a time.
  - Using **CH/TRK** (▲/▼) buttons for channel selection jumps to the next channel memorized in Auto Channel Memory.

- 6** Press the ◀▶ buttons to select **Add** or **Delete**, then press the **ENTER** button.

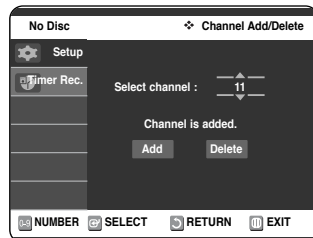

## RF Output Channel

When you connect the DVD Recorder & VCR to TV with RF Antenna Cable, follow the steps below to set the RF Output Channel.

- 1** With the unit in Stop mode/No Disc mode, press the **MENU** button.
- 2** Press the ▲▼ buttons to select **Setup**, then press the **ENTER** or ► button.

- 3** Press the ▲▼ buttons to select **Channel Set**, then press **ENTER** or ► button.

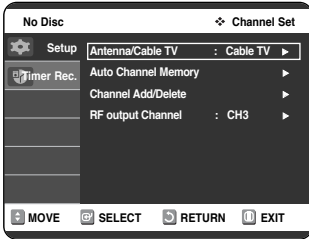

- 4** Press the ▲▼ buttons to select **RF output Channel**, then press the **ENTER** or ► button.

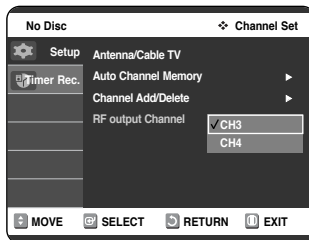

- 5** Press the ▲▼ buttons to select **CH3/CH4**, then press the **ENTER** or ► button.

- 6** A message will appear on your TV. When the message disappears, change your TV to channel 3 or 4 to match the RF Output Channel of the player.

## Setting Up the Language Options

If you set audio, subtitle, disc menu and on-screen menu language in advance, they will come up automatically every time you watch a movie. If the selected language is not recorded on the disc, the original pre-recorded language is selected.

- 1** With the unit in Stop mode/No Disc mode, press the **MENU** button.

- 2** Press the ▲▼ buttons to select **Setup**, then press the **ENTER** or ► button.

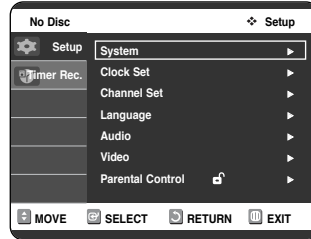

- 3** Press the ▲▼ buttons to select **Language**, then press the **ENTER** or ► button. Language setup menu will be displayed.

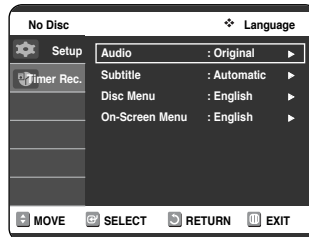

- 4** Press the ▲▼ buttons to select the desired language option, press the **ENTER** or ► button.

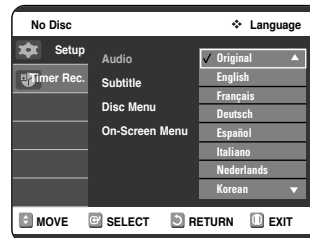

- **Audio** : For the disc audio language.
- **Subtitle** : For the disc subtitles.
- **Disc Menu**: For the disc menu contained on the disc.
- **On-Screen Menu**: For the on-screen menu of your DVD Recorder & VCR.

- 5** Press the ▲▼ buttons to select the desired language, then press the **ENTER** or ► button.



Note

- Press the **RETURN** or ◀ button to return to the previous menu. Press the **MENU** button to exit the menu.
- The selected language will only appear if it is supported on the disc.

# Setting Up the Audio Options

Allows you to setup the audio device and sound status settings depending on the audio system in use.

**1** With the unit in Stop mode/No Disc mode, press the **MENU** button.

**2** Press the **▲▼** buttons to select **Setup**, then press the **ENTER** or **▶** button.

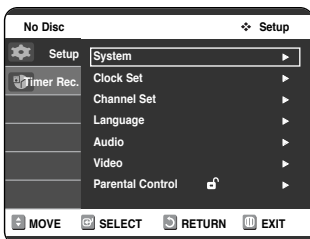

**3** Press the **▲▼** buttons to select **Audio**, then press the **ENTER** or **▶** button. Audio setup menu will be displayed.

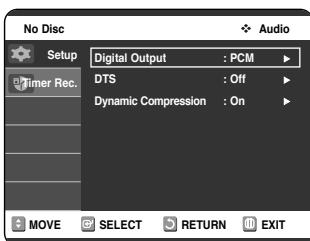

**4** Press the **▲▼** buttons to select the desired audio option, then press the **ENTER** or **▶** button.

**5** Press the **▲▼** buttons to select the desired item, then press the **ENTER** or **▶** button.

**Note** ■ Press the **RETURN** or **◀** button to return to the previous menu. Press the **MENU** button to exit the menu.

## Digital Output

- 1. PCM :** Converts to PCM(2CH) 48kHz audio. Select PCM when using the Analog Audio Outputs.
- 2. Bitstream :** Converts to Dolby Digital Bitstream (5.1CH). Select Bitstream when using the Digital Audio Outputs.



Note

- Be sure to select the correct Digital Output or no audio will be heard.

## DTS

- 1. Off :** Doesn't output digital signal.
- 2. On :** Outputs DTS Bitstream via digital output only. Select DTS when connecting to a DTS Decoder.



Note

- When DTS soundtrack is played, sound is not output from Analog Audio Output.

## Dynamic Compression

This is only active when a Dolby Digital signal is detected.

- 1. Off :** You can enjoy the movie with the standard Dynamic Range.
- 2. On :** When the Movie soundtracks are played at low volume or from smaller speakers, the system can apply appropriate compression to make low-level content more intelligible and prevent dramatic passages from getting too loud.

# Setting Up the Display(Video) Options

This function allows you to setup the TV screen settings.

**1** With the unit in Stop mode/No Disc mode, press the **MENU** button.

**2** Press the **▲▼** buttons to select **Setup**, then press the **ENTER** or **▶** button.

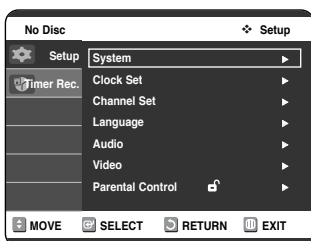

**3** Press the **▲▼** buttons to select **Video**, then press the **ENTER** or **▶** button. Video option menu will be displayed.

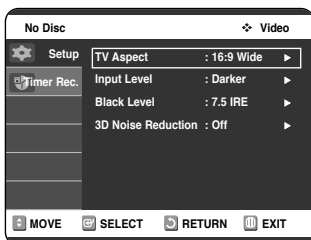

**4** Press the **▲▼** buttons to select the desired video option, then press the **ENTER** or **▶** button.

**5** Press the **▲▼** buttons to select the desired item, then press the **ENTER** or **▶** button.



Note

- Press the **RETURN** or **◀** button to return to the previous menu. Press the **MENU** button to exit the menu.

## TV Aspect

Depending on the type of television you have, you may want to adjust the screen setting. (aspect ratio)

- 4:3 Letter Box** : Select when you want to see the total 16:9 ratio screen DVD supplies, even though you have a TV with a 4:3 ratio screen. Black bars will appear at the top and bottom of the screen.
- 4:3 Pan - Scan** : Select this for a conventional size TV when you want to see the central portion of the 16:9 screen. (Extreme left and right side of movie picture will be cut off.)
- 16:9 Wide** : You can view the full 16:9 picture on your widescreen TV.

## Input Level

Adjusts the level of the input signal.

- Darker** : If you feel the screen is too light and you want to make the screen darker.
- Lighter** : If you feel the screen is too dark and you want to make the screen lighter.

## Black Level

Adjusts the black level of the screen.

- 0 IRE** : This is the standard NTSC reference black level for consistent brightness/contrast across all sources. Select this when you want darker screen.
- 7.5 IRE** : This will enhance the black level for increased brightness/contrast when viewing DVDs. Select this when you want lighter screen.

## 3D Noise Reduction

- Off** : Normal
- On** : Select to remove noise from the screen.



Note

- This function depends on disc type. It may not work for some disc types.
- IRE**: Short for the Institute of Radio Engineers. An IRE unit is a relative unit of measure equaling 1/140th of the peak-to peak (p-p) video amplitude.

# Setting Up the Parental Control

The Parental Control function works in conjunction with DVDs that have been assigned a rating - which helps you control the types of DVDs that your family watches. There are up to 8 rating levels on a disc.

**1** With the unit in Stop mode/No Disc mode, press the **MENU** button on the remote control.

**2** Press the **▲▼** buttons to select **Setup**, then press the **ENTER** or **▶** button.

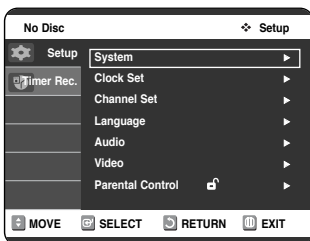

**3** Press the **▲▼** buttons to select **Parental Control**, then press the **ENTER** or **▶** button.

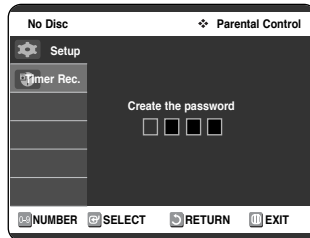

**4** Create a 4-digit password using the 0 to 9 buttons on the remote control.

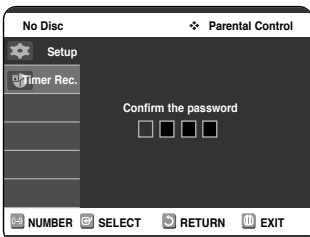

**5** The Re-enter Password screen appears to confirm the password. Enter your password again, and then press the **ENTER** or **▶** button.

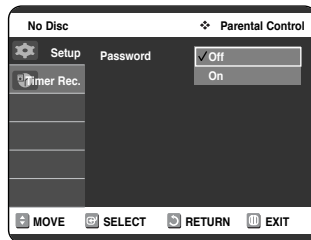

**6** Press the **▲▼** buttons to select **On**, then press the **ENTER** or **▶** button. The Parental Control screen appears.



- Press the **RETURN** or **◀** button to return to the previous menu. Press the **MENU** button to exit the menu.
- Refer to Troubleshooting if you forget your password. (See page 83)

## About the Rating Level

**1** Press the **▲▼** buttons to select **Rating Level**, then press the **ENTER** or **▶** button.

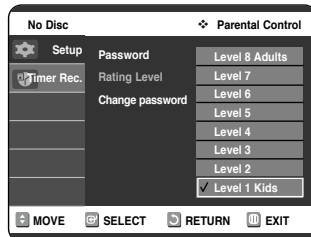
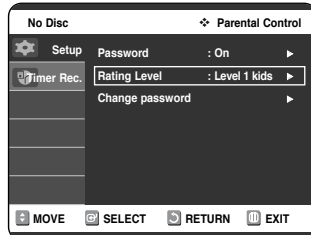

**2** Press the **▲▼** buttons to select the rating level you want, then press the **ENTER** or **▶** button. For example, if you select up to Level 6, discs that contain Level 7, 8 will not play. A larger number indicates that the program is intended for adult use only.

## About the Change Password

- 1 Press the ▲▼ buttons to select **Change Password**, then press the **ENTER** or ► button.

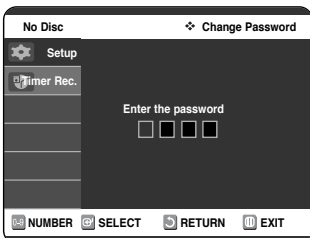
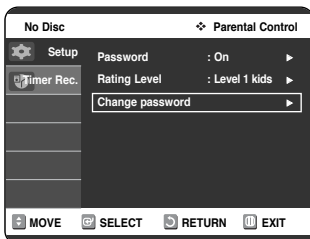

- 2 Enter the 4-digit password using the 0 to 9 buttons on the remote control. The 'Confirm the password.' message will be displayed.

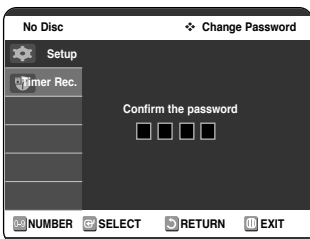

- 3 Enter your password again using the 0 to 9 buttons on the remote control.



- Press the **RETURN** or ◀ button to return to the previous menu. Press the **MENU** button to exit the menu.

## VCR Setting



If you want your videotapes to play automatically when you insert them, turn on Auto Play.



- Only tapes that are missing the Record Safety Tab will play automatically when inserted.

- 1 With the unit in Stop mode/No Disc mode, press the **MENU** button.
- 2 Press the ▲▼ buttons to select **Setup**, then press the **ENTER** or ► button.

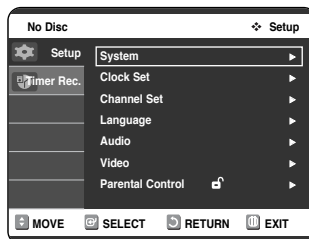

- 3 Press the ▲▼ buttons to select **System**, then press the **ENTER** or ► button.

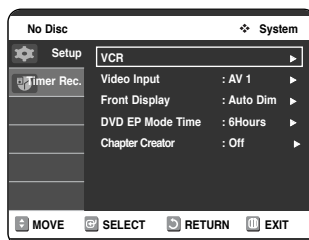

- 4 Press the ▲▼ buttons to select **VCR**, then press the **ENTER** or ► button.

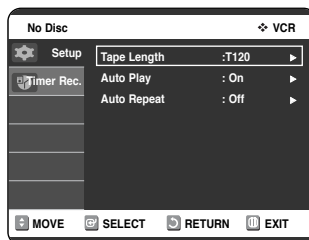

**5** Press the ▲▼ buttons to select the desired VCR option, then press the **ENTER** or ► button.

**6** Press the ▲▼ buttons to select the desired item, then press the **ENTER** or ► button.

## Tape Length

This information is usually printed on the tape box. The menu cycles through: T-120, T-160 or T-180. Once the type of cassette is set, the VCR can display the amount of time remaining on the tape when you press the **INFO** button.

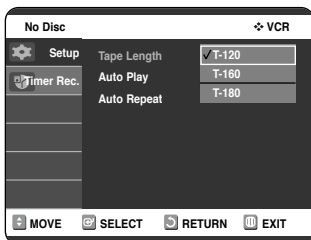

## Auto Play

- **Off** - Auto play is disabled.
- **On** - The VCR will automatically begin playing a video tape when it is inserted, as long as the safety tab of the cassette has been removed.

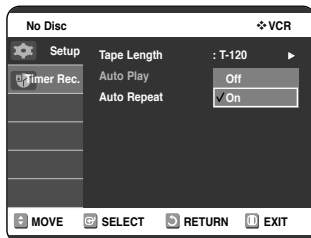

## Auto Repeat

It sets the VCR to play a tape repeatedly (unless a tape control is activated :Stop, Fast Forward or Rewind).

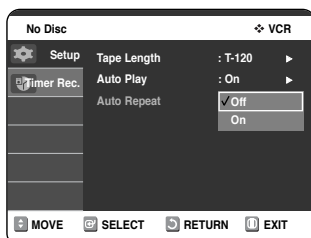

## Video Input

If you watch video through AV IN 1, you can choose AV 1(Composite) or S-video.

**1** With the unit in Stop mode/No Disc mode, press the **MENU** button.

**2** Press the ▲▼ buttons to select **Setup**, then press the **ENTER** or ► button.

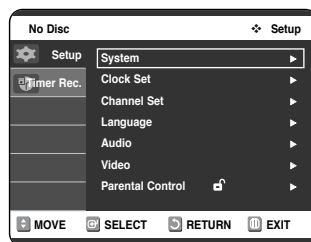

**3** Press the ▲▼ buttons to select **System**, then press the **ENTER** or ► button.

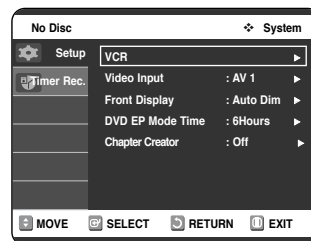

**4** Press the ▲▼ buttons to select **Video Input**, then press the **ENTER** or ► button.

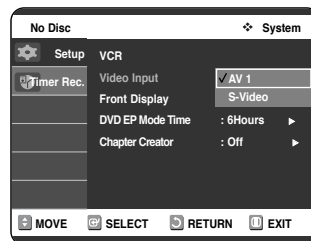

**5** Press the ▲▼ buttons to select **AV 1** or **S-Video**, then press the **ENTER** or ► button.



# Front Display

Adjust the brightness of the unit's front display.

- 1 With the unit in Stop mode/No Disc mode, press the **MENU** button.
- 2 Press the **▲▼** buttons to select **Setup**, then press the **ENTER** or **▶** button.

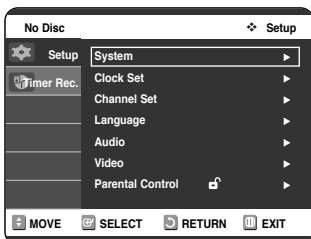

- 3 Press the **▲▼** buttons to select **System**, then press the **ENTER** or **▶** button.

- 4 Press the **▲▼** buttons to select **Front Display**, then press the **ENTER** or **▶** button.

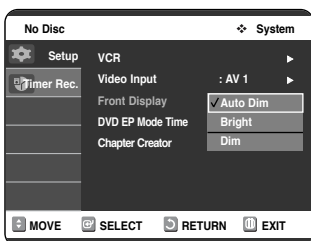

- 5 Press the **▲▼** buttons to select the desired item, then press the **ENTER** or **▶** button.
  - **Auto Dim** – Front Display will dim automatically during power off.
  - **Bright** – Front Display will be bright all the time.
  - **Dim** – Front Display will be dim all the time.

# DVD EP Mode Time

You can set the EP(Extended Play)mode's time setting to 6 or 8hours.

- 1 With the unit in Stop mode/No Disc mode, press the **MENU** button.
- 2 Press the **▲▼** buttons to select **Setup**, then press the **ENTER** or **▶** button.

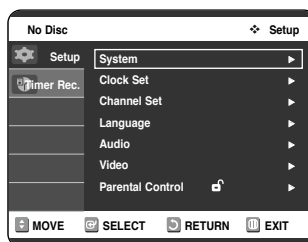

- 3 Press the **▲▼** buttons to select **System**, then press the **ENTER** or **▶** button.

- 4 Press the **▲▼** buttons to select **DVD EP Mode Time**, then press the **ENTER** or **▶** button.

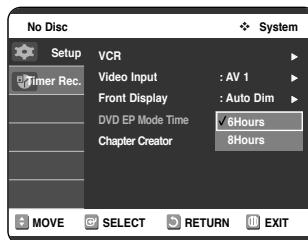

- 5 Press the **▲▼** buttons to select **6 Hours** or **8 Hours**, then press the **ENTER** or **▶** button.

# Automatic Chapter Creator

This function only works with DVD-RW (Video mode) and DVD-R discs.

A DVD-Video consists of 'Titles' and 'Chapters'. When you record one program, it makes one Title. If you use this function, the Title will be divided into Chapters.

**1** With the unit in Stop mode/No Disc mode, press the **MENU** button.

**2** Press the **▲▼** buttons to select **Setup**, then press the **ENTER** or **▶** button.

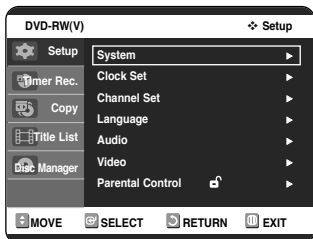

**3** Press the **▲▼** buttons to select **System**, then press the **ENTER** or **▶** button.

**4** Press the **▲▼** buttons to select **Chapter Creator**, then press the **ENTER** or **▶** button.

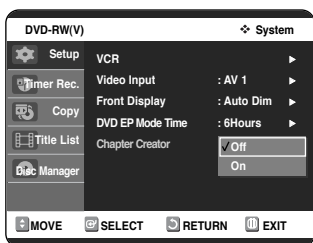

**5** Press the **▲▼** buttons to select **On**, then press the **ENTER** or **▶** button.

Press the **MENU** button to exit the menu.

**6** Set the recording speed by pressing the **REC SPEED** button on the remote (see page 53 for more information on recording speeds).

**7** Press the **REC** button to start recording. The message "Do you want to create the chapter menu after this recording?" is displayed.

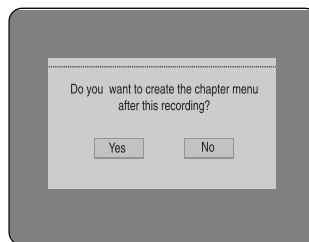

**8** Press the **◀▶** buttons to select **Yes** and press the **ENTER** button and recording begins. In XP and SP mode, you must record at least 5 minutes to create a chapter. In LP and EP mode, 15 minutes.

**9** Press the **STOP** button to stop recording.

**10** To display the created titles, finalize the disc (see page 79) and then press the **TITLE MENU** button. The title menu will be displayed.

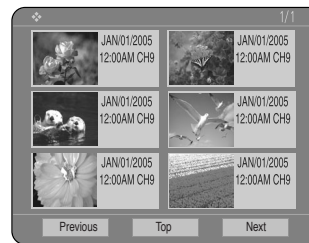

**11** To display the created chapters, select the desired Title and then press the **DISC MENU** button. The chapter menu for the selected Title will be displayed.



Note

- On DVD-RW discs, additional chapters and titles can be added to a finalized disc by unfinalizing and recording again. On DVD-R discs, once finalized, no additional chapters or titles can be recorded.



CAUTION

- The Automatic Chapter Creator function does not work during Timer Recording or when you turn the power off.
- DVD-R discs cannot be unfinalized.

# Playback

This section introduces basic functions of playback by disc type.



Dolby Digital



DTS



Digital Audio



Stereo



NTSC broadcast system in U.S.A, Canada, Korea, Japan, etc.



MP3

## ◆ DVD Playback

Before Playing .....	35
Playing a Disc .....	36
Using the Disc Menu and Title Menu .....	37
Using the Search & Skip Functions .....	37
Slow Motion Play / Step Motion Play .....	38
About ANYKEY .....	38
Repeat Play.....	39
Selecting the Subtitle & Audio Language.....	41
Changing the Camera Angle.....	42
Zooming-In .....	42
Using the Bookmarks .....	43
Using the Markers .....	44
Playing back an Audio CD (CD-DA).....	45
Playing back an MP3 CD.....	46
Play Option Mode.....	47
To Program Tracks.....	47
Playing a picture CD.....	48

## ◆ VCR Playback

Playing the VCR.....	49
Tracking.....	49
Special VCR Playback Features.....	49
S-VHS Playback .....	49
Variable Search System.....	50

# Before Playing

Read the following information before playing a disc.

## Region code (DVD-Video only)



Both the DVD Recorder & VCR and the discs are coded by region. These regional codes must match in order for the disc to play. If the codes do not match, the disc will not play. The Region Number for this DVD Recorder & VCR is described on the rear panel of the DVD Recorder & VCR.

## Disc types that can be played

Disc Types	Disc Logo	Recorded content	Disc Shape	Max. Playing Time
DVD-VIDEO		AUDIO + VIDEO	Single sided(5")	240
			Double sided(5")	480
			Single sided(3.5")	80
			Double sided(3.5")	160
AUDIO-CD		AUDIO	Single sided(5")	74
			Single sided(3.5")	20
JPEG CD-R/RW		JPEG Images	Single sided(5")	-
			Single sided(3.5")	-
MP3 CD-R/RW		MP3 Audio	Single sided(5")	-
			Single sided(3.5")	-
DVD-RAM		AUDIO + VIDEO	Single-sided 5" (4.7GB)	1 (XP: Excellent Quality) 2 (SP: Standard Quality) 4 (LP: Long Playback) 6 or 8 (EP: Extended)
			Double-sided 5" (9.4GB)	2 (XP: Excellent Quality) 4 (SP: Standard Quality) 8 (LP: Long Playback) 12 or 16 (EP: Extended)
DVD-RW		AUDIO + VIDEO	5" (4.7GB)	1 (XP: Excellent Quality) 2 (SP: Standard Quality) 4 (LP: Long Playback) 6 or 8 (EP: Extended)
DVD-R		AUDIO + VIDEO	5" (4.7GB)	1 (XP: Excellent Quality) 2 (SP: Standard Quality) 4 (LP: Long Playback) 6 or 8 (EP: Extended)

## Discs that cannot be played

- DVD-Video with a region number other than "1" or "ALL"
- 3.9 GB DVD-R Disc for Authoring.
- DVD-RAM not recorded following the Video Recording Standard
- Unfinalized DVD-R, unfinalized DVD-RW(V mode)
- PAL discs
- DVD-ROM/DVD+RW/PD/MV-Disc/DIVX Video Disc, etc
- Video CD/CVD/SVCD/CD-ROM/CDV/CD-G/CD-I



- This DVD Recorder & VCR can only operate with discs that are compatible with DVD-RAM Standard Version 2.0.
- Playback and/or recording may not work for some types of discs, or when specific operations, such as angle change and aspect ratio adjustment, are being performed. Information about the discs is written in detail on the box. Please refer to this if necessary.
- Do not allow the disc to become dirty or scratched, fingerprints, dirt, dust, scratches or deposits of cigarette smoke on the recording surface may make it impossible to use the disc for recording.
- DVD-RAM/-RW/-R discs may not be able to play on some DVD players, depending on the player, disc and the condition of the recording.
- Discs with PAL programs recorded on them cannot be recorded using this product.

## Playing a Disc



1

Press the **OPEN/CLOSE** button.

2

Place a disc gently into the tray with the disc's label facing up.

3

- Press **OPEN/CLOSE** button to close the disc tray.
- Your DVD Recorder & VCR closes the disc tray and plays the disc automatically.
- The recorder does not play discs automatically after the initial power on.
- When the recorder is powered on and a disc is in the tray, the unit will be activated and wait in stop status.
- Press the **PLAY** button to start playback.
- If you insert a MP3 Disc, your DVD Recorder & VCR will display the file list on the screen and start playing.
- If you insert a JPEG Disc, folders and a file list are displayed.
- If you want the unit to play automatically when it is powered on with a disc in the unit, power on with the **PLAY** button.

4

Press the **STOP** button to stop playback.



- When you stop disc play, the DVD Recorder & VCR remembers where you stopped. When you press **PLAY** button again, it will pick up where you left off. (unless the disc is removed or the DVD Recorder & VCR is unplugged, or if you press the **STOP** button twice.) This function is only applicable to DVD-VIDEO, DVD-RAM, DVD-RW, DVD-R or Audio CDs (CD-DA).



- Do not move your DVD Recorder & VCR while playing, as this may cause damage to the disc.
- Make sure to press the **OPEN/CLOSE** button to open or close the disc tray.
- Do not push the disc tray while it is being opened or closed, as this may cause a product malfunction.
- Do not place foreign materials on or in the disc tray.
- Some functions may perform differently or be disabled depending on the disc type. If this occurs, refer to the instructions written on the disc case.
- Be especially careful that children's fingers are not caught between the disc tray and the tray chassis when it closes.
- After turning power on, it will take a few seconds until the DVD Recorder & VCR operates.

# Using the Disc Menu and Title Menu

Some discs contains a dedicated menu system that allows you to select special functions for title, chapters, audio track, subtitles, film previews, information on characters, etc.

## For DVD-VIDEO disc



- 1 Press the **DISC MENU** button to enter the disc menu of the disc.
  - Move to the setup menu related to playback operation.
  - You can select audio language and subtitle etc. provided by the disc.

- 2 Press the **TITLE MENU** button to move to the title menu of the disc.
  - Use this button if the disc contains more than one title. Some discs may not support the title menu functionality.

## For DVD-RAM/DVD-RW/DVD-R disc



- 1 Press the **TITLE LIST** button to display title list.



Note

- **Title List** : Title List shows a list to help you select a title. Since the title list consists of the information on video that is actually recorded, if one title is deleted, that title cannot be played again.
- **Play List** : This refers to a unit of playback, which is made by selecting a desired scene in the entire Title List. When one playlist is played, only the scene selected by the user will play and then stop. Since only the information necessary for playing a desired scene is included in a playlist, even if that playlist is deleted, the original recording will not be deleted.

# Using the Search & Skip Functions

## Searching through a Chapter or Track



During the playback, press the **SEARCH** ◀◀ or ▶▶ button on the remote control. Each time you press the **SEARCH** button, the playback speed will change as follows.

DVD-VIDEO/ DVD-RAM/DVD-RW DVD-R	FF1/FR1→FF2/FR2→FF3/FR3→ FF4/FR4→FF5/FR5→FF6/FR6
AUDIO CD(CD-DA)	◁FF1/FR1→FF2/FR2→FF3/FR3▷

- You can scan the program in reverse order. To return to normal speed playback, press the **▶▶II** button.



Note

- No sound is heard during Scan(Search) mode, except CDs (CD-DA).

## Skipping Chapters or Tracks

During the playback, press the **I◀◀** or **▶▶I** button on the remote control.

- **If you press the I◀◀ button**  
If you press the **I◀◀** button, it moves to the beginning of the chapter, track or marker(DVD-RAM, DVD-RW(VR mode) ). Pressing the button once again within 3 seconds returns to the beginning of the previous chapter, track or marker(DVD-RAM, DVD-RW(VR mode) ).
- **If you press the ▶▶I button**  
If you press the **▶▶I** button, it moves to the next chapter, track or marker(DVD-RAM, DVD-RW(VR mode) )

## Skipping ahead 30 seconds

During the playback, press **F.ADV/SKIP** button to skip ahead exactly 30 seconds.

# Slow Motion Play/ Step Motion Play

## Slow Motion Play (DVD-VIDEO / DVD-RAM / DVD-RW / DVD-R)



During pause mode, press the **SEARCH** ◀◀ or ▶▶ button on the remote control for more than 1 second.

- Each time you press the ▶▶ button :  
▶▶ X 1/8 → ▶▶ X 1/4 → ▶▶ X 1/2
- Each time you press the ◀◀ button :  
◀◀ X 1/8 → ◀◀ X 1/4 → ◀◀ X 1/2

To return to normal speed playback, press the ▶|| button.

## Step Motion Play (DVD-VIDEO/DVD-RAM / DVD-RW / DVD-R)



During pause mode, press the **F.ADV** button on the remote control.

- Each time the button is pressed, a new frame will appear.

To return to normal speed playback, press the ▶|| button.



- No sound is heard during STEP or SLOW mode.

# About ANYKEY

The ANYKEY functions allows you to easily search for a desired scene by accessing title, chapter, track and time. You can also change the subtitle and audio settings and set some features including Repeat, Angle and Zoom.

## Moving to a scene directly using the ANYKEY

- If you want to move to a title, a chapter or a track to find a desired scene.

**1** Press the **ANYKEY** button during playback.



**2** Press the ▲▼ buttons to select **Title**, **Chapter** or **Track**.



**3** Press the ◀▶ buttons or number (0~9) buttons to select the desired scene. Then, press the **ENTER** button.

- If you want to move to a desired time to help you find a scene.

**1** Press the **ANYKEY** button during playback.



**2** Press the **▲▼** buttons to select **Time**.



**3** Enter the time in the sequence of hours, minutes, and seconds using the number buttons, then press the **ENTER** button.



Note

- This may not work for some discs. When an Audio CD(CD-DA) or a MP3 disc is inserted, according to a disc type, the information display may not be appear.
- The Time Search function does not operate in some discs.
- To make the screen disappear, press the **ANYKEY** again.

## Repeat Play



### Playing Repeatedly(Repeat Playback)



**1** Press the **ANYKEY** button during playback.



**2** Press the **▲▼** buttons to select **Repeat**.



**3** Select repeat mode using **◀▶** button. Press the **ENTER** button.

- To make the screen disappear, press the **ANYKEY** or **RETURN** button.



Note

- DVD-RAM, DVD-RW(VR mode), unfinalized DVD-R and unfinalized DVD-RW (Video mode) do not repeat a chapter.

## Playing Repeatedly(Repeat Playback)



- 1 Press the **ANYKEY** button during playback. Repeat is highlighted.

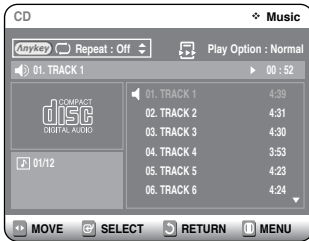

- 2 Press the **▲▼** buttons to select the **Track** or **Disc** you want to play repeatedly. Press the **ENTER** button. For MP3 discs, you can select **Track**, **Folder** or **Disc**.

- To return to normal playback -

- 3 Press the **CLEAR** button to return to normal playback.

## Playing a Certain section Repeatedly(A-B Repeat Playback)



- 1 Press the **ANYKEY** button during playback.



- 2 Press the **▲▼** buttons to select **Repeat**.



- 3 Press the **◀▶** button to select **A-B**, then press the **ENTER** button.

- 4 Press the **ENTER** button at the point where you want the repeat play to start (A) and press it again at the point where you want the repeat play to stop (B). Repeat playback of the A-B section starts.



Note

- If you set point (B) before five seconds has lapsed, the prohibition mark (⊘) will appear.
- You can also activate Normal Playback by pressing the **CLEAR** button.
- CDs do not support the Repeat A-B function.

- To return to normal playback -

- 5 Press the **CLEAR** button to return to normal playback.



# Selecting the Subtitle & Audio Language



## Selecting the SUBTITLE language

Subtitle languages may not work depending on the disc type. This is only available during playback.



### Using the SUBTITLE button

- 1 Press the **SUBTITLE** button during playback.



- 2 Press the **▲▼** buttons to select the desired subtitle language.

• To make the screen disappear, then press the **CLEAR** or **RETURN** button.

ANYKEY

### Using the ANYKEY button

- 1 Press the **ANYKEY** button during playback.



- 2 Press the **▲▼** buttons to select **Subtitle**, then press the **◀▶** buttons to select the desired subtitle language.



Note

- The subtitle display may be different depending on the disc type.
- If the subtitles overlap, disable the caption function on your TV.
- Some discs allow you to select the language for the disc menu only.

## Selecting the Audio language

Audio languages may not work depending on the disc type. This is only available during playback.

- 1 Press the **ANYKEY** button during playback.



- 2 Press the **▲▼** buttons to select **Audio**, then press the **◀▶** buttons to select the desired audio language.



Note

- Audio languages may be different because they are disc-specific.
- Some discs allow you to select the audio language for the disc menu only.

# Changing the Camera Angle



When a DVD Recorder & VCR contains multiple angles of a particular scene, you can select the Angle function.



## Using the ANGLE button

If the disc contains multiple angles, the **ANGLE** appears on the screen.

- 1 Press the **ANGLE** button, then the ANGLE icon will appear with the current angle number and the number of angles available.
- 2 Press the **▲▼** button to select the desired angle.



## Using the ANYKEY button

- 1 Press the **ANYKEY** button during playback.



- 2 Press the **▲▼** buttons to select **Angle**, then press the **◀▶** buttons or number (0~9) buttons to select the desired angle scene.



Note

- This function is disc-dependent, and may not work all DVDs.
- This function does not work when a DVD has not been recorded with a multi-camera angle system.

# Zooming-In



- 1 Press the **ANYKEY** button during playback.



- 2 Press the **▲▼** buttons to select **Zoom**, then press the **ENTER** button. (🔍) will be displayed.



- 3 Press **▲▼**, **◀▶** buttons to move to the area you want to enlarge.

- 4 Press the **ENTER** button. The screen will be enlarged to twice the normal size. The screen size will be enlarged to four times the normal size.

DVD-VIDEO/ DVD-RAM/DVD-RW/ DVD-R	normal size → 2X → 4X → 2X → normal size
--	---



Note

- When recording is done in the EP mode, the Zoom function will not be supported. (except when the recording has been done in V mode)

# Using the Bookmarks

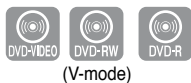

Set marks at scenes you want to see again so that you can start playback from the marked position.

- 1 Press the **MARKER** button during playback.

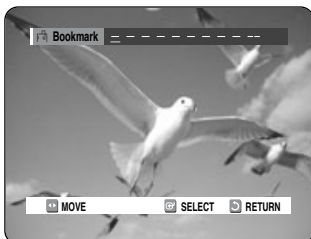

- 2 Press the **ENTER** button when the desired scene appears.
  - The number 1 is displayed and the scene is memorized.



- 3 Press the **◀▶** button to move to the next position.

- 4 Press the **ENTER** button again when the desired scene appears.
  - The number 2 is displayed and the scene is memorized. Repeat above to bookmark other positions. You can bookmark up to 10 scenes.

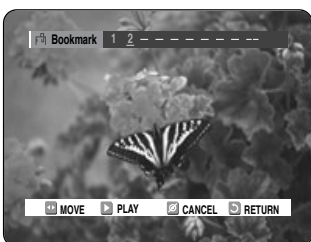

## Playing back a Bookmark

- 1 Press the **MARKER** button.

- 2 Press the **◀▶** buttons to select a bookmarked scene.

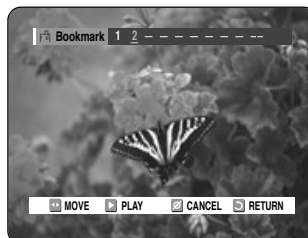

- 3 Press the **ENTER** or **▶||** button to start playing from the selected scene.

## Clearing a Bookmark

- 1 Press the **MARKER** button.

- 2 Press the **◀▶** buttons to select a bookmarked scene.

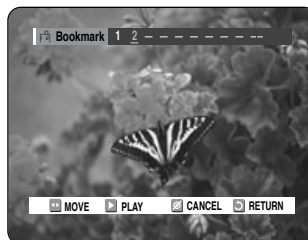

- 3 Press the **CLEAR** button to delete the selected bookmark.

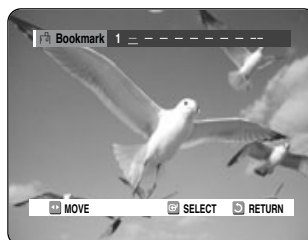

# Using the Markers



**1** Press the **MARKER** button during playback.

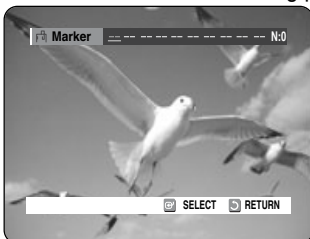

**2** Press the **ENTER** button when the desired scene appears.

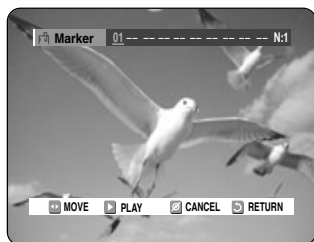

- The number 01 is displayed and the scene is memorized.

**3** Press the **◀▶** button to move to the next position.

**4** Press the **ENTER** button again when the desired scene appears.

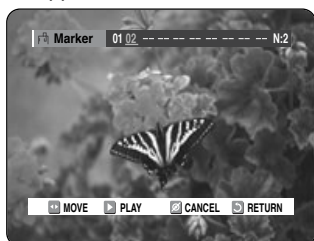

- The number 02 is displayed and the scene is memorized.
- DVD-RAM or DVD-RW (VR Mode) discs have the Marker function instead of the Bookmark function. The Marker function allows you to mark up to 99 scenes. Since the scenes may be displayed as many different pages, numbering is necessary. If a disc in use is encoded with Disc Protect, Markers cannot be set or deleted. Only playback is available.

## Playing back a Marker

**1** Press the **MARKER** button during playback.

**2** Press the **◀▶** buttons to select a marked scene.

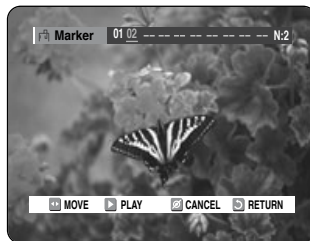

**3** Press the **ENTER** or **▶||** button to start playing from the selected scene.

- If you press the **NEXT SKIP (▶▶)** button or the **PREVIOUS SKIP (◀◀)** button in marker mode, and the next or current marked point plays for shorter than three seconds, playback starts from the previous marked point.

## Clearing a Marker

**1** Press the **MARKER** button during playback.

**2** Press the **◀▶** buttons to select a marked scene. Press the **CLEAR** button to delete the selected mark.

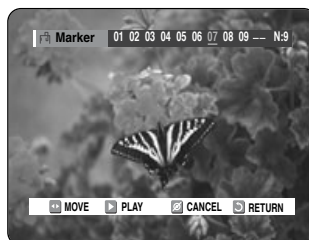

- When a marker is cleared while DVD-RAM/ DVD-RW(VR mode) is playing, marker numbers will change. For example, if the 7th marker is cleared after ten markers are registered, the marker numbers after the eighth will automatically move ahead by one and the 8th marker becomes the 7th.

# Playing back an Audio CD (CD-DA)

Each disc has a variety of menu functions available.

## Playing an Audio CD(CD-DA)

- 1 Insert an Audio CD (CD-DA) into the disc tray.
  - The Audio CD menu appears and the tracks (songs) are played automatically.

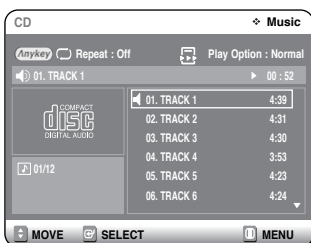

- 2 Press the ▲▼ buttons to select the track (song) to start playback from, and then press the ENTER button.
  - You can also select the track (song) by pressing the number buttons on the remote.

## Audio CD(CD-DA) Screen Elements

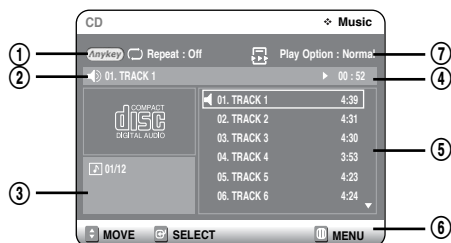

1. **Repeat mode:** Repeat off/Repeat Track/Repeat Disc.
2. **Current track (song):** Displays the number of the track currently being played.
3. Displays the current play index and total track number.
4. This shows the operating state of a disc and a playback time corresponding to a portion that is currently played.
5. Displays the track list (song list) and the playing time of each track.
6. Button display.
7. **Play Option:** Normal, Random, Intro or Playlist

## Buttons on the Remote Control used for CD playback



1. ▲▼, 0~9: Selects a track (song).
2. ► : Plays the selected track (song).
3. ENTER button: Plays the selected track (song).
4. ►► button: Plays the next track.
5. ◀◀ button: Returns to the beginning of the current track when pressed during playback. If pressed again, your DVD Recorder & VCR moves to and plays the previous track. If you press this button within three seconds after playback starts, the previous track will be played. If you press this button after three seconds, the current track will be replayed from the beginning.
6. Press the (◀◀/►►) button: Fast Play (FF1/FR1, FF2/FR2, FF3/FR3)
7. ■ : Stops a track(song).
8. ►|| : Plays a track(song) or pauses playback.
9. ANYKEY : To select the top menu on screen display (Repeat or Play Option).

# Playing back an MP3 CD

## Playing an MP3 Disc

- 1 Insert an MP3 CD into the disc tray.
  - The MP3 menu is displayed and the tracks (songs) are played automatically.

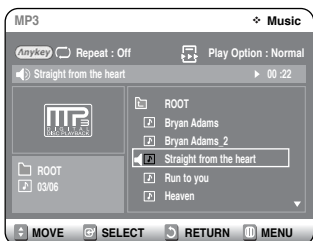

- 2 Press the ▲▼ buttons to select the folder you want to hear, and then press the ENTER button.
  - Press the ▲▼ buttons to select the track (song) you want to hear, and then press the ENTER button.
  - You can also select the desired track (song) by pressing the number buttons on the remote.

## MP3 Screen Elements

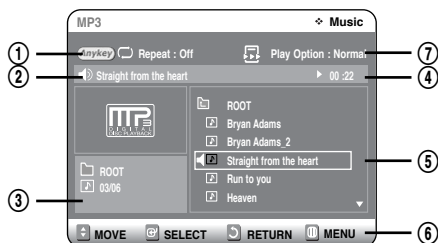

1. **Repeat mode:** Repeat off, Repeat Track, Repeat Folder or Repeat Disc
2. **Current track (song):** Displays the name of the track being played.
3. Displays the current folder and play index.
4. This shows the operating state of a disc and a playback time corresponding to a portion that is currently played.
5. Displays the information for the folder and its tracks.
6. Button display.
7. **Play Option :** Normal, Random, Intro or Playlist

## Playing back an MP3 Disc



1. ▲▼, 0~9: Selects a track (song).
2. ► : Plays the selected track (song).
3. ENTER button: Plays the selected track (song) or displays the files in the selected folder.
4. RETURN button: Moves to the folder to which the current song belongs.
5. ►► button: Plays the next track.
6. ◀◀ button: Returns to the beginning of the current track when pressed during playback. If pressed again, your DVD Recorder & VCR moves to and plays the previous track.
  - If you press this button within three seconds after playback starts, the previous track will be played.
  - If you press this button after three seconds, the current track will be replayed from the beginning.
7. ■ : Stops a track(song).
8. ►|| : Plays a track(song) or pauses playback.
9. ANYKEY : To select the top menu on screen display (Repeat or Play Option).

# Play Option Mode

The Play Option can be used with an Audio CD or MP3 in the Play or Stop mode.

- 1 Press the **ANYKEY** button during playback. Repeat mode will be highlighted.

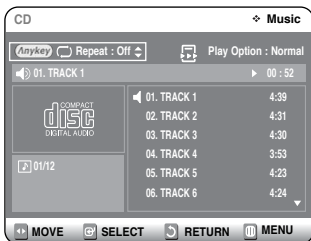

- During Stop, Play option will be highlighted.

- 2 Press the **◀▶** buttons to select **Play Option**.

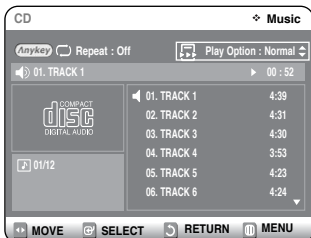

- 3 Press the **▲▼** buttons to select a desired track, then press the **ENTER** button.
  - **Normal:** Tracks on a disc are played in the order in which they were recorded on the disc.
  - **Random:** The Random option plays a disc's tracks in random order. After a random list is generated and played completely, another random list is generated and played. Random Play is continued until the play option is changed.
  - **Intro:** The first 10 seconds of each track will be played. If you want to listen to the music that you have selected, press the **ENTER** button or **▶||** button. The play option will be changed to Normal Play. When Intro Play is completed, Normal Play is performed.
  - **Playlist:** The Playlist playback option allows you to select the order in which you want tracks to play.

# To Program Tracks

You can register a maximum 30 tracks in the playlist.

- 1 Press the **ANYKEY** button during playback. Repeat mode will be highlighted.
  - During Stop, Play option will be highlighted.
- 2 Press the **◀▶** buttons to select **Play Option**.
- 3 Press the **▲▼** buttons to select **Playlist**, then press the **ENTER** button. Playlist screen is displayed.

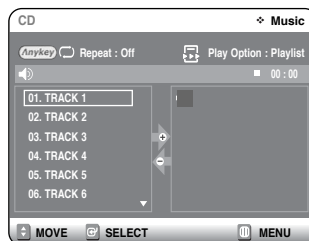

- 4 Press the **▲▼** buttons to select tracks in the order in which you want them to play, then press the **ENTER** button.

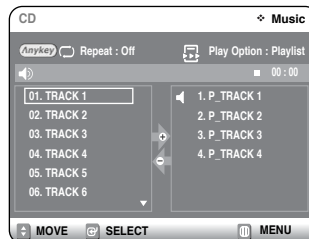

- 5 If you playlisted a wrong track, press the **▶** button, then press the **▲▼** buttons to select wrong track. Press the **CLEAR** button. The wrong track will be removed.

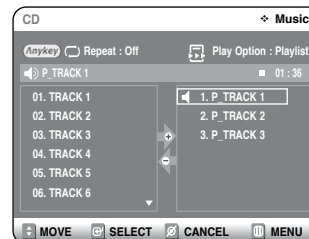

- 6 Press the **PLAY** button to playback the playlist.

# Playing a picture CD



There are two types of Picture CDs. One is a CD with only JPEG files. The other one is a CD with JPEG files and MP3 files.(mixed CD)

1. When a mixed CD is played, a menu will be shown in order to let you choose which contents, either JPEG or MP3, you want to play.
  - 1-1. If you want to play MP3 files on a mixed CD, choose Music on the menu, then it will take you to the MP3 play back screen.
  - 1-2. If you want to play JPEG files on a mixed CD, choose Photo on the menu, then it will take you to photo playback screen. See number 3 on this page.
2. When a Picture CD(CD with only JPEG files) is played, the recorder will show the Album screen,with thumbnail images. See number 3 on this page.

**1** Insert a Picture CD(JPEG only) or Mixed CD(JPEG + MP3)into the disc tray.

**2** When playing a Mixed CD, press the ▲▼ buttons to select **Photo**, then press the **ENTER** or ► button. (when playing a Picture CD, see number 3 on this page.)

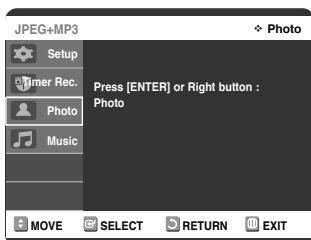

**3** Press the ▲▼◀▶ buttons to select a picture.

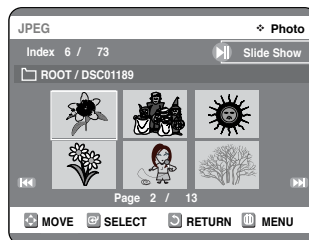

- To see the next 6 pictures, press the ►► button.
- To see the previous 6 pictures, press the ◀◀ button.

**4-1** If you press the ►|| button, the Slide show screen will appear. Press the ◀▶ buttons to set the slide show speed, then press the **ENTER** button.

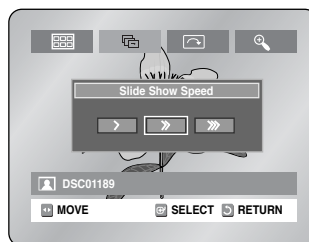

**4-2** Press the ◀▶ buttons to select a picture file in Album screen and then press the **ENTER** button.

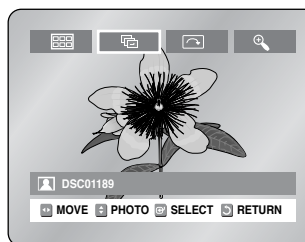

- : Returns to the Album screen.
- : The unit enters slide show mode. Before the slide show can begin, the picture interval (Slide show speed) must be set.
- : Each time the **ENTER** button is pressed, the picture rotates 90 degrees clockwise.
- : Each time the **ENTER** button is pressed, the picture is enlarged up to 4X(four times the normal size).  
Normal → 2X → 4X → 2X → Normal

- Press the **ANYKEY** button to display menu bar.
- Press the **RETURN** button to clear the menu bar.



## Playing the VCR



To play a standard VHS tape, just insert it into the VCR deck and press the **PLAY** button. You can turn on the Auto Play to enable the VCR deck to play automatically when you insert a videotape that is missing the Record Safety Tab.

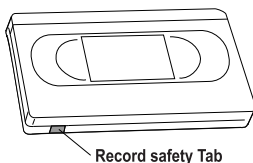

- 1 Insert a standard VHS tape into the VCR deck.
  - When a tape is inserted, power will turn on automatically.
- 2 Press the **▶II(PLAY/PAUSE)** button on the remote control or on the front panel of the unit. The videotape will begin to play automatically if the Record Safety Tab is removed and Auto Play is turned on.
- 3 Press the **■(STOP)** button on the remote control or on the front panel of the unit.

## Tracking



The Tracking adjustment removes the white lines that sometimes appear during playback because of slight differences in recording decks. The **CH/TRK** ( $\wedge/\vee$ ) button will automatically align the recorded tracks with the playback heads to solve this problem. You may also set tracking manually.

- 1 **Adjust Tracking Manually**  
During playback, press the **CH/TRK** ( $\wedge/\vee$ ) buttons to remove white lines from the picture.

## Special VCR Playback Features



While a videotape is playing, you can enjoy a variety of special playback features, including Still, Frame Advance, Skip, Slow motion, and more.

### Pause

In Play mode, press **▶II(PLAY/PAUSE)** button to still a single frame.

### Frame Advance

In the pause mode, press **F.ADV/SKIP** button to advance to the next frame.

### Fps/Review

In Play mode, press Forward (**▶▶**) button or Rewind (**◀◀**) button to Cue/review at two speeds:

- Picture Search - Press and release to advance the tape forward or backward at 5 times normal speed.
- Jet Search - Press and hold to advance the tape forward or backward at 7 times normal speed.

### Skip

In Play mode, press **F.ADV/SKIP** button to cue ahead exactly 30 seconds. Press **F.ADV/SKIP** button repeatedly up to 4 times to cue ahead 2 minutes.

### Slow motion

In pause mode, press **▶▶** button for slow motion. Press the **▶▶** button repeatedly to vary slow motion speed from 1/5 to 1/30 of normal playback. Press the **PLAY** button twice to resume normal viewing.

## S-VHS Playback



The DVD Recorder & VCR allows you to playback high quality S-VHS tapes.

- 1 Insert an S-VHS tape into the VCR deck.
- 2 Press **▶II(PLAY/PAUSE)** button on the remote control or on the front panel to begin playback of the S-VHS tape.

# Variable Search System



Each time you record a cassette on this DVD Recorder & VCR, an "index" is automatically marked on the tape when recording starts. The Search function allows you to fast-forward or rewind to a specific index and start playback from that point. Depending on the direction selected, the indexes are numbered as follows

- This DVD Recorder & VCR uses a standard indexing system (VISS). As a result, it will recognize any indexes marked by other VCRs using the same system and vice versa.

## Go To [0:00:00] Stop

Use this feature when you want to search for the 0:00:00 counter position on a cassette.

- 1 Press the **CLEAR** button at the point on the tape where you want to set the counter to 0:00:00.
- 2 While a cassette is stopped, press the **ANYKEY** button.

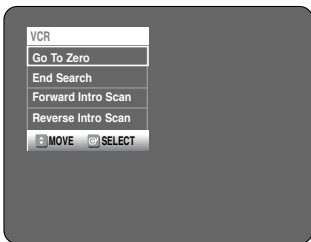

- 3 Press the **▲▼** buttons to select **Go To Zero**, then press the **ENTER** button. The VCR will rewind or fast forward, searching for the 0:00:00 counter position, and then automatically stop at that position.

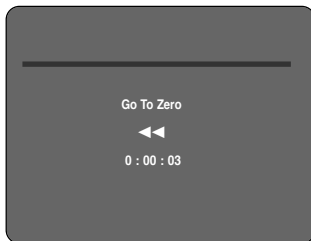

## End Search

Use this feature when you want to search for a blank position to record a program on a cassette.

- 1 While a cassette is stopped, press the **ANYKEY** button.

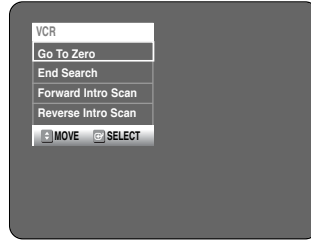

- 2 Press the **▲▼** buttons to select **End Search**, then press the **ENTER** button. The VCR will fast forward, searching for a blank position, and then automatically stop at that position. If the VCR reaches the end of the tape during end search, the tape will be ejected.

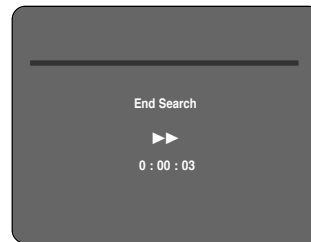

## Forward/Backward Intro Scan

Use scan and play when you don't know exactly where a program is located on a cassette tape.

- 1 While a cassette is stopped, press the **ANYKEY** button.

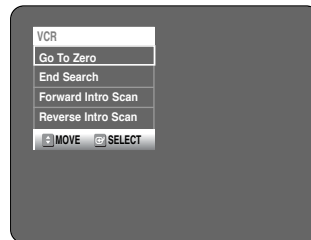

- 2 Press the **▲▼** buttons to select **Forward Intro Scan** or **Backward Intro Scan**, then press the **ENTER** button. When an Index mark is found, the DVD Recorder & VCR will playback the tape for 5 seconds, after which it will continue searching for the next Index mark.

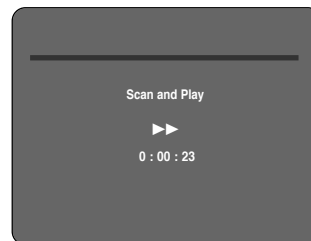

# Recording

This section shows various DVD recording methods.

- ◆ DVD Recording
  - Before Recording .....51
  - Recordable discs .....51
  - Recording Formats .....52
  - Recording Mode .....52
  - Unrecordable video .....52
  - Recording the current channel you are watching .....53
  - Recording From External Devices .....54
  - Recording through a DV Input jack.....54
  - Making a One Touch Recording(OTR) .....55
  - Making a Timer Recording .....55
  - Editing the Scheduled Record List .....57
  - Deleting a the Scheduled Record List.....58
- ◆ VCR Recording
  - Basic VCR Recording.....59
  - Check Remaining Time .....59
  - Special Recording Features .....60
  - Copy to DVD or VCR.....61

## Before Recording

This unit can record on various types of discs. Before recording, read the following instructions and select the disc type according to your preference.

### Recordable discs

This recorder can record on the following discs.

DVD-RAM	DVD-RW	DVD-R
		

- DVD-RWs and DVD-RAMs are rewritable.
- DVD-Rs are non-rewritable.

### Compatibility between Samsung and Other Company's Recorder.

Disc Types	Recording format	Recording Device	Finalizing	Additional Recording in Samsung Recorder
DVD-RAM	VR Mode	Samsung	X	Recordable
		Other Company	X	Recordable
DVD-RW	VR Mode	Samsung	finalized	Not recordable
			not finalized	Recordable
	Other Company	finalized	Not recordable	
		not finalized	Recordable	
DVD-R	V Mode	Samsung	finalized	Not recordable
			not finalized	Recordable
	Other Company	finalized	Not recordable	
		not finalized	Not recordable	



Note

- Finalize
  - This closes the DVD-RW/R so no additional recording can be done.
- Unfinalize
  - This allows additional recording on a DVD-RW disc originally recorded on the DVD-VR320.
  - A DVD-RW disc that has been recorded by DAO(Disc At Once) in a PC cannot be unfinalized.
  - A DVD-RW disc that has been recorded in Video Mode of a different maker's recorder cannot be unfinalized.
  - A DVD-R disc cannot be unfinalized.

## Recording Formats

When you insert an unused disc, the following message appears. Since available functions differ depending on the disc type, select a disc that best fits your preferences.

DVD-RAM: Use after formatting the disc.



DVD-RW: When an unused DVD-RW disc is first inserted, the message "Do you want to initialize this disc" will be displayed. If you select Yes, the disc will be formatted in VR mode.



If you want to change the mode, refer to Formatting a Disc on page 78.

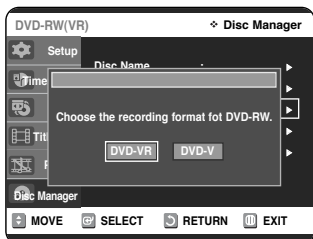

DVD-R: Formatting DVD is unnecessary and only Video Mode Recording is supported.

### DVD-RW(Video mode)-R

- Chapters will be created automatically when you finalize recording on DVD-R/DVD-RW discs in Video mode with the Chapter Creator has been set to On.
- Simple editing (erasing titles/changing title name).

### DVD-RW(VR mode)-RW

- This mode involves multiple editing functions (such as deletion of the whole title, partial deletion of a title, etc.).
- Various editing options using a created Playlist.

## 52 - English

## Recording Mode

Select one of four recording modes by pressing the **REC SPEED** button repeatedly while the unit is in Stop mode for the desired recording time and picture quality. In general, picture quality improves as the recording time decreases.

In AUTO Mode, picture quality is adjusted automatically so that all images for the scheduled time can be recorded onto the free disc space.

Mode	Characteristic	Recording Times Data Rates
XP (high quality mode)	Select when the video quality is important.	Approx. 1 hours about 8 Mbps
SP (standard quality mode)	Select to record in standard quality.	Approx. 2 hours about 4 Mbps
LP (long recording mode)	Select when a long recording time is required.	Approx. 4 hours about 2 Mbps
EP (extended mode)	Select when a long recording time is required.	Approx. 6 hours/ about 1.2 Mbps Approx. 8 hours/ about 0.8 Mbps
AUTO	for timer recording only see page 56.	Approx 60 to 480 Min approx 0.8 to 8Mbps

## Unrecordable video

Pictures with copy protection cannot be recorded on this DVD Recorder & VCR.

When the DVD Recorder & VCR receives a copy guard signal while recording, recording stops and the following message appears on the screen.

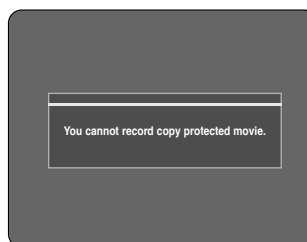

## Concerning Copy Control Signals

TV broadcasts that contain copy control signals may have one of the following three signal types, Copy-Free, Copy-Once and Copy-Never. If you want to record a copy-once type program, use DVD-RW with CPRM in VR Mode and DVD-RAM.

	Copy-Free	Copy-Once	Copy-Never
DVD-RW(Ver.1.1)	O	-	-
DVD-RW(Ver.1.1) with CPRM			
VR mode	O	O*	-
Video mode	O		-
DVD-R	O	-	-
DVD-RAM(Ver.2.0)	O	O*	-

Once "Copy Once" has been recorded, additional recording cannot be performed.

This \* marked parts are compatible with CPRM.

### - Content Protection for Recordable Media (CPRM)

CPRM is a mechanism that ties a recording to the media on which it is recorded. It is supported by some DVD recorders, but not by many DVD players. Each blank recordable DVD has a unique 64-bit media ID etched in the BCA. When protected content is recorded onto the disc, it can be encrypted with a 56-bit C2 (Cryptomeria) cipher derived from the media ID. During playback, the ID is read from the BCA and used to generate a key to decrypt the contents of the disc. If the contents of the disc are copied to other media, the ID will be absent or wrong and the data will not be decryptable.

## Recording the current channel you are watching



1. Check the antenna cable is connected.
2. Check the remaining time on the disc.

DVD-RAM/DVD-RW discs should be formatted in advance before beginning recording. Most new discs are sold unformatted. Make sure to format your unformatted discs before recording.

- 1 Press the **OPEN/CLOSE** button and place a recordable disc on the disc tray.

- 2 Press the **OPEN/CLOSE** button to close the disc tray.  
Wait until "LOAD" disappears from the front panel display.

- 3 Press the **CH/TRK** (^/∨) buttons or number buttons to select the channel you want to record.

- 4 Press the **REC SPEED** button repeatedly, to select the recording speed (quality).
  - XP(High, approx. 1 hour) → SP(Standard, approx. 2 hours) → LP(Low, approx. 4 hours) → EP(Extended Play, approx. 6 hours/8hours)



- 5 Press the **REC** button.
  - "●" is displayed on the screen and recording begins.

- 6 Press the **STOP** button to stop or finish a recording in progress.
  - The message "Updating the information of disc. Please wait for a moment" is displayed.

### Pausing / Resuming

- Press the **REC PAUSE** button to pause a recording in progress.
- Press the **REC PAUSE** button again during pause to resume recording.
- You can switch channels by pressing the **CH/TRK** (^/∨) buttons while recording pauses.



Note

- You can not change the recording mode and the channel while recording.
- Recording will stop automatically if there is no free space left for recording.
- Up to 99 titles can be recorded onto a disc.
- If the power interrupted due to power failure or other reasons, the title being recorded will not be saved onto the disc.
- Recording will stop automatically if a copy protected image is selected.
- Do not use DVD-R authoring discs with this unit.

## Recording From External Devices

Follow these directions to record onto a disc or a tape from External Devices.

- 1 Connect the AV out jack of your External Devices to the AV IN jack on the front or rear of your DVD Recorder & VCR using Audio/Video Cable.
- 2 Power on your DVD Recorder & VCR and switch to AV In mode by pressing the **INPUT SEL.** button on the remote control .  
The front panel display changes in the following sequence depending on the Video input setting in the menu.  
AV1: [ Channel Number → AV 1 → AV 2 → DV ]  
S-Video: [ Channel Number → SUPER → AV IN 2 → DV ]
- 3 Press the **REC SPEED** button repeatedly to select the recording speed(quality).  
[ SP → LP → EP → XP ]
- 4 When your DVD Recorder & VCR is in the stop mode, set the operation mode of your External Devices to play mode.
- 5 Press the **REC** button on your DVD Recorder & VCR to start recording when the desired video is displayed from the external device.
- 6 Press the **STOP** button on your DVD Recorder & VCR when the recording is finished.



Note

- Also refer to the user manual for your External Devices when recording through AV In jacks on the DVD/VCR using Audio/Video cables.
- For more information on changing the Video Input from AV1 to S-Video, see page 32(Video Input).

## Recording through a DV Input jack

You may control the Camcorder using the IEEE1394 (DV) interface.

Follow these directions to record onto a disc or tape from a camcorder that has a DV output jack.

- 1 Connect the DV output jack of your camcorder to the DV input jack on the front of your DVD Recorder & VCR using a DV cable.
- 2 Power on your DVD Recorder & VCR and switch to DV mode by pressing the **INPUT SEL.** on the remote control.
- 3 Press the **REC SPEED** button repeatedly to select the recording speed(quality).  
[ SP → LP → EP → XP ]
- 4 Press the **INPUT SEL.** button to select DV.  
If the input is set to DV, a playback/record menu that enables camcorder control appears on the top of the screen.



- 5 Select the Play icon on the upper part of the screen to playback the camcorder and find the starting position to copy.  
You can press the **PLAY** button on the remote control to playback the camcorder.
- 6 To start recording, Press the ◀▶ button to select rec(●) icon in the top side of the screen, then press the **ENTER** button.  
You can press the **REC** button of the remote control to start recording. To display playback related icons on the screen, press any direction button on the remote control.
- 7 Press the **STOP** button on your DVD Recorder & VCR when the recording is finished.



Note

- Some camcorders may not work with your DVD Recorder & VCR even if they have a DV output jack.
- Also refer to the user manual for your camcorder when recording through a DV jack.

# Making a One Touch Recording (OTR)



One-Touch Recording (OTR) allows you to add recording time in 30-minute increments up to 4 hours by pressing the **REC** button.

- 1 Press the **CH/TRK** ( $\wedge/\vee$ ) buttons or number buttons to select the channel to record.  
If you want to record through a connected external component, press the **INPUT SEL.** button to select an appropriate external input (AV1, AV2 or DV).
  - CATV channel: 1 to 125
  - TV channel: 2 to 69

- 2 Press the **REC** button to start recording.

- 3 While in Record mode, press the **REC** button again to activate One-Touch Recording (OTR).
  - Record length 0:30 appears on the On-Screen Display and the DVD Recorder & VCR will record for exactly 30 minutes.

- 4 Continue pressing REC to add recording time in 30 minute increments up to 4hours.  
(see page 52)
  - The DVD Recorder & VCR stops recording automatically when the time has elapsed.

## To stop recording

Press the **STOP** (■) button.  
The message "Press Stop button once more to cancel Timer Record" is displayed.  
Press the **STOP** (■) button again.  
The message "Updating the Information of disc. Please wait for a moment" is displayed.



Note

- The timer counter decreases by the minute from 4:00 to 0:00, then the DVD Recorder & VCR stops recording.

# Making a Timer Recording



The clock (Initial Setup – Clock Set) must be set before proceeding with a timer recording. (See page 24)

- 1 Press the **OPEN/CLOSE** button, and place a recordable disc on the disc tray.
- 2 Press the **OPEN/CLOSE** button to close the disc tray.  
Wait until "LOAD" disappears from the front panel display.
- 3 With the unit in Stop mode, press the **MENU** button.
- 4 Press the  $\blacktriangle/\blacktriangledown$  buttons to select **Timer Rec.**, then press the **ENTER** or  $\blacktriangleright$  button.

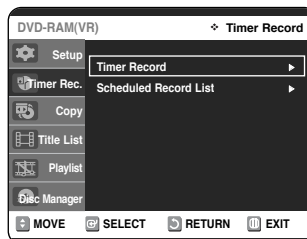

- 5 Press the  $\blacktriangle/\blacktriangledown$  buttons to select **Timer Record**, then press the **ENTER** or  $\blacktriangleright$  button.  
You can also set a timer recording via the **TIMER REC** button.  
The Timer Recording screen are displayed.

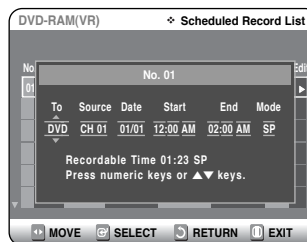

**6** Fill in the items using the ▲▼◀▶ buttons.

- ◀▶ : Moves to the previous/next item,
- ▲▼ 0~9 : Sets a value.

- **To** : Select the media to record DVD or VCR.
- **Source** : The video input source (AV 1, AV 2 ), or the broadcasting channel you want to make a timer recording of.
- **Date**: Date that the timer recording starts

```

      ▲
      01/31
      01/30
      :
      01/02
Present Date 01/01
             MON-FRI
             Sun's
             Mon's
             :
             Sat's
      ▼
  
```

- **Start/End Time** : Start and end time of the timer recording.

### • Recording mode (DVD)

**AUTO** : Select when you want to set video quality automatically. It depends on the remaining time on the DVD.

**XP** (high quality) : Select when audio and video qualities are important. (Approx. 1 hour)

**SP** (standard quality) : Select to record in standard quality. (Approx. 2 hours)

**LP** (low quality) : Select when a long recording time is required.(Approx. 4 hours)

**EP** (extended mode) : Select when a longer recording time is required. (Approx.6 hours at 1.2 Mbps or Approx.8 hours at 0.8 Mbps )



Note

- When you are recording at EP mode on a DVD-RW(V)/R disc, it may not record the full 6 or 8 hours because the unit uses the VBR(Variable Bit Rate) ENCODING system. For example, if you record a program with a lot of action, it uses a higher bit rate which in turn consumes more disc memory.

### • Recording mode (VCR)

**AUTO** : Select when you want to set video quality automatically. It depends on remaining time of VCR tape.

**SP** : Standard Play, for best picture quality.

**SLP** : Super Long Play, for maximum recording time (3 times SP).

**7**

Press the **ENTER** button.

- will appear on the front panel. It means that a timer recording is registered.

### If the timer settings overlap

The programs are recorded in order of priority.

If timer recording is set for the first program and then again for the second program and both programs overlap, the following message will appear on the screen: "This setting is identical with 1.2" The message shows that the first program has priority. After recording of the first program is complete, the second program starts being recorded.

### To exit without saving the current setting

Press the **MENU** or **TIMER REC** button.

### To return to the previous menu

Press the **RETURN** button if you don't want to set a timer recording.

**8**

Turn the power off to finish the timer recording.

- will blink if disc or tape is not inserted.



Note

- The timer recording time may differ from the set time depending on disc status and overall timer recording status (for example, recording times overlapping, or when the previous recording ends within 3 minutes before the start time of the next recording.)



# Editing the Scheduled Record List



Follow these directions to edit the timer record list.

**1** Press the **MENU** button.

**2** Press the **▲▼** button to select **Timer Rec.**, then press the **ENTER** or **▶** button.

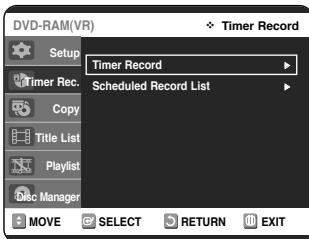

**3** Press the **▲▼** button to select **Scheduled Record List**, then press the **ENTER** or **▶** button.

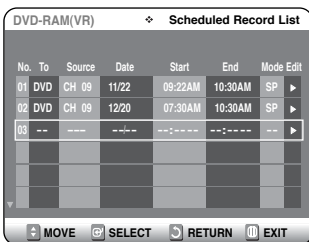

**4** Press the **▲▼** button to select the number of the scheduled record list you want to edit, then press the **ENTER** or **▶** button.

- The Edit and Delete items are displayed.

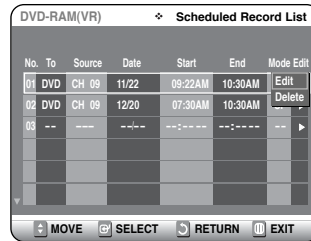

**5** Press the **▲▼** button to select **Edit**, then press the **ENTER** button.

- The Timer Recording screen is displayed. Edit the items you want to modify. See the Timer Recording section for more information on Timer Recording Input items. (See page 56)

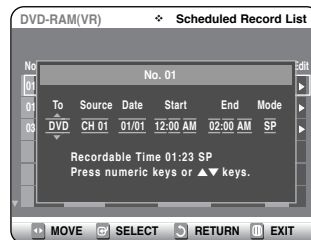

**6** Press the **ENTER** button to confirm the edited setting.

**7** Press the **MENU** button after finishing the operation. The menu screen will disappear.

# Deleting the Scheduled Record List



Follow these directions to delete a title from the timer record list.

**1** Press the **MENU** button.

**2** Press the **▲▼** button to select **Timer Rec.**, then press the **ENTER** or **▶** button.

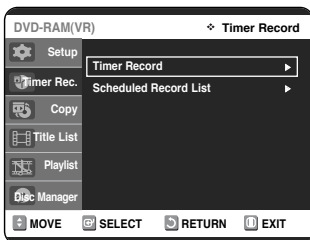

**3** Press the **▲▼** button to select **Scheduled Record List**, then press the **ENTER** or **▶** button.

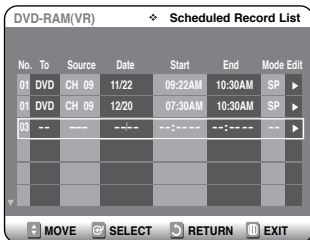
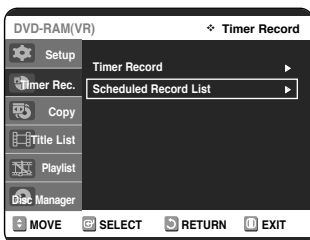

**4** Press the **▲▼** button to select the number of the scheduled record list you want to delete, and then press the **ENTER** button.

- The Edit and Delete items are displayed.

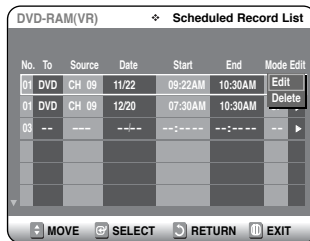

**5** Press the **▲▼** button to select **Delete**, then press the **ENTER** or **▶** button.

- You will be prompted with the delete confirm message such as 'Do you want to delete No.01?'.

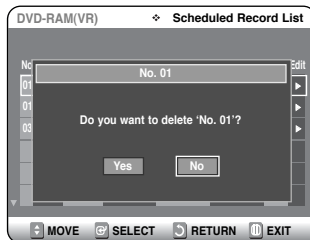

**6** Press the **◀▶** buttons to select **Yes**, then press the **ENTER** button.

- The selected title will be deleted from the list.

**7** Press the **MENU** button after finishing the operation. The menu screen will disappear.



Note

- You can not delete programs that are currently recording.

# Basic VCR Recording



## Before starting

1. Check TV channel and Antenna connections.
2. Check the remaining time on the tape.

You can record a TV show in progress by inserting a blank tape and pressing the **●(REC)** button. You can even add time in 30-minute increments up to 4 hours by pressing the **●(REC)** button repeatedly.



Note

- Be sure your videotape has a Record Safety Tab. If the tab is missing, you can cover the opening with a small piece of tape.



CAUTION

- Warning: Do not cover this opening unless you are sure you want to record over the tape.

- 1 Insert a blank VHS tape into the VCR deck.
  - Make sure the tape is long enough to record the entire program.

- 2 Press the **0–9** buttons or the **CH/TRK** ( $\wedge/\vee$ ) buttons to select the desired channel. Press the **INPUT SEL.** button to select AV 1, AV 2 or DV if recording from an external device connected to the front or rear AV inputs, respectively.

- 3 Press the **REC SPEED** button on the remote control to set the Record Speed to one of the following options:
  - SP – Standard Play, for best picture quality.
  - SLP – Super Long Play, for maximum recording time (3 times SP).



Note

- The selected Record Speed will appear on the front panel display and on-screen display.

## Maximum Recording Time - SP vs. SLP

Tape Length	SP (Standard Play)	SLP (Super Long Play)
T-120	2 hrs	6 hrs
T-160	2hrs 40 mins	8 hrs
T-180	3 hrs	9 hrs



Note

- When you watch or record on the VCR during DVD Recording, some function buttons may not operate. The message “This function is not available.” will be displayed.

- 4 Press the **●(REC)** button on the remote control or front panel. For options while recording is in progress, see “Special Recording Features”. ( see page 60)

- 5 Press the **STOP** button to stop or finish a recording in progress.

## Pausing / Resuming

- Press the **REC PAUSE** button to pause a recording in progress.
- Press the **REC PAUSE** button again during pause to resume recording.
- You can switch channels by pressing the **CH/TRK** ( $\wedge/\vee$ ) buttons while recording pauses.

## Check Remaining Time



- 1 Press **INFO.** button on the remote control. Following information will be displayed. (Current deck status, recording speed, remaining time, input channel, current time.)

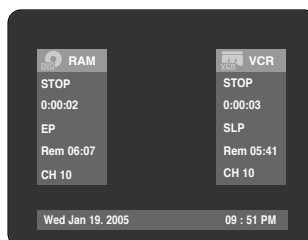

# Special Recording Features



While a recording is in progress, you can watch a different channel, watch a different media, or add recording time in 30-minute increments.

## 1 Watch a Different Channel

When you watching through the Antenna input during recording, press the TV/VCR button on the remote control. Change the channel you want to watch.

- When you watching through AV input during recording, change the input of your TV from AV to Antenna.

Change the channel you want to watch.

## 2 Watch a different media during recording

You can watch a DVD during VCR recording or watch a Video tape during DVD recording.

- During VCR recording, insert a DVD in the DVD deck. The output will automatically change to the DVD and start playback.
- During DVD recording, insert a Video tape in the VCR deck. The output will automatically change to the VCR and start playback. (Only if tape is missing the safety tab)

## 3 Add Recording Time

Refer to the One-Touch Recording (OTR).  
(See page 55)

## 4 Recording DVD and VCR at the same time

You can record DVD and VCR at the same time, but both modes must be set up to record separately.

- Press the **DVD/VCR** button to set the unit to DVD or VCR mode.
- Choose AV input mode (CH, AV1, AV2 or DV) for DVD or VCR.
- Choose REC mode for DVD or VCR.
- Press **REC** button for DVD or VCR.



Note

- When DVD Recorder & VCR is connected to your TV using S-Video or component video cable, the playback screen on the video tape will not display during DVD recording.
- You cannot record different channels at the same time.
- The DVD and VCR cannot start recording at the exact same time. You must set one mode to start recording, then the other.

# Copy to DVD or VCR



You can copy from the DVD to VCR or VCR to DVD. Check the remaining time on the tape.

## To copy from DVD to VCR



- 1 With the unit in Stop mode, press the **MENU** button.
- 2 Press the **▲▼** buttons to select **Copy**, then press the **ENTER** or **▶** button.

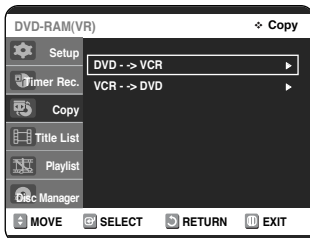

- 3 Press the **▲▼** buttons to select **DVD --> VCR**, then press the **ENTER** or **▶** button.

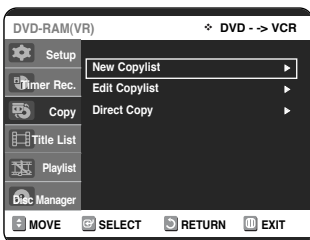

- 4 Press the **▲▼** buttons to select **Edit Copylist**, then press the **ENTER** or **▶** button.

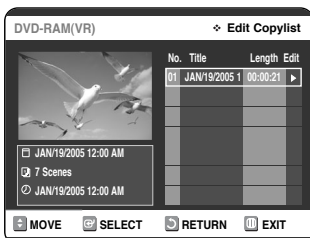

- 5 Press the **▲▼** buttons to select desired copylist, then press the **ENTER** or **▶** button.

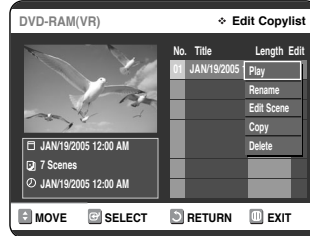

- 6 Press the **▲▼** buttons to select **Copy**, then press the **ENTER** or **▶** button.

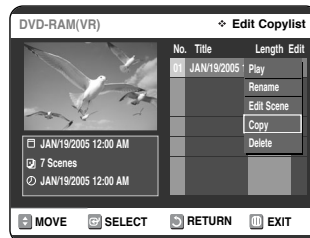

## Direct copy DVD to VCR

- Insert a DVD disc you want to copy.
- Insert a VHS tape.
- Press the VCR copy button on front panel or remote control(TO VCR).
- To stop recording, press the **STOP** button.

## To copy from VCR to DVD

**1** With the unit in Stop mode, press the **MENU** button in stop mode.

**2** Press the **▲▼** buttons to select **Copy**, then press the **ENTER** or **▶** button.

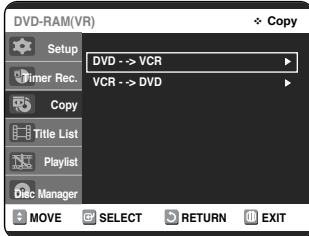

**3** Press the **▲▼** buttons to select **VCR->DVD**, then press the **ENTER** or **▶** button.

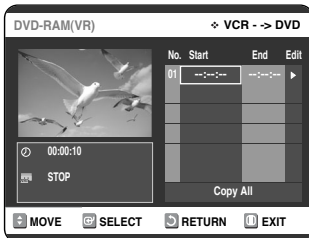

**4** You can use the **▶II**, **I◀◀** or **▶▶I**, **◀◀** or **▶▶** buttons to search for the Start position. Press the **ENTER** button at the start point.

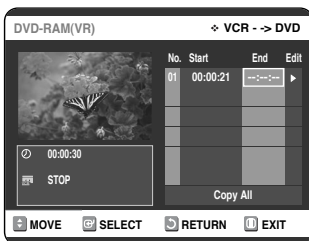

**5** You can use the **▶II**, **I◀◀** or **▶▶I**, **◀◀** or **▶▶** buttons to search for the end position. Press the **ENTER** button at the end point.

- A copylist will be generated.
- Repeat the above steps to create the copylist.
- In VCR mode, the copylist cannot be saved.

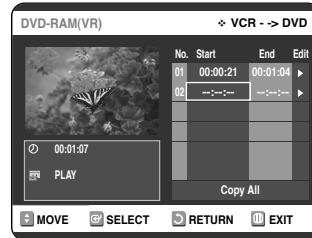

**6** Press the **▲▼** buttons to select desired copylist, then press the **ENTER** or **▶** button.

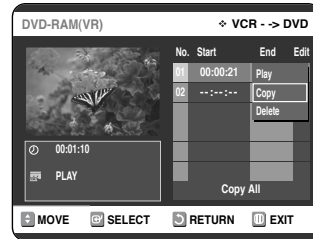

**7** Press the **▲▼** buttons to select **Copy**, then press the **ENTER** or **▶** button.

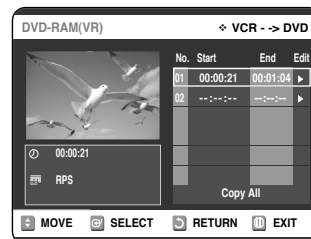

- The VCR will fast forward, searching for a start position and then automatically start a copy.
- It may not match up with Start and END point exactly.
- If you want to copy all content, select **Copy All**.

## Direct copy VCR to DVD

- Insert the VHS tape you want to copy.
- Insert Recordable DVD disc.
- Press DVD copy button on front panel or remote control(TO DVD).
- To stop recording press the **STOP** button.

# Editing

This section introduces basic functions of DVD editing and explains both edit functions for the recording on a disc and edit functions for the entire disc.

Playing the Title List.....	63
Basic Editing (Title List) .....	65
Renaming(Labeling) a Title .....	65
Locking(Protecting) a Title .....	66
Deleting a Title .....	66
Deleting a Section of a Title .....	67
Advanced Editing (Play List).....	69
Creating a playlist .....	69
Playing Titles in the Playlist.....	70
Renaming a Playlist Title.....	71
Editing a Scene for the Playlist.....	72
Copying a Playlist Title to the VCR .....	75
Deleting a Playlist Title from the Playlist .....	76
Disc Manager .....	77
Disc Protection.....	78
Formatting a Disc.....	78
Finalizing a disc.....	79
Delete All Title Lists.....	80
Unfinalizing a disc (VVR mode).....	81

## Playing the Title List



Follow these instructions to play back a scene from the Title List.

### Using the TITLE LIST button

- 1 Press the **TITLE LIST** button.  
The Title List screen is displayed.

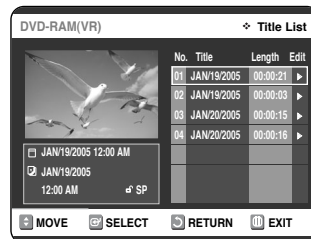

- 2 Press the **▲▼** buttons to select a title you want to play from Title List, and then press the **PLAY** button.  
The selected title will be played back.

- 3 To stop title play, press the **STOP** button.  
To return the title list screen, press the **TITLE LIST** button.

### Using the MENU button

- 1 Press the **MENU** button.

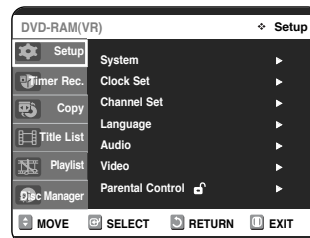

- 2** Press the ▲▼ buttons to select **Title List**, then press the **ENTER** or ► button twice. The Title List screen is displayed.

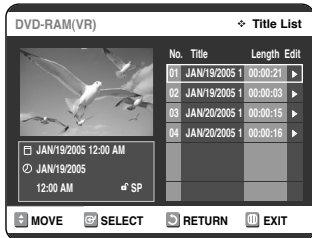

- 3** Press the ▲▼ buttons to select a Title, then press the **ENTER** or ► button. The Edit menu is displayed: Play, Rename, Delete, Edit, Protection (See pages 69~72)



- 4** Press the ▲▼ buttons to select **Play** to play the title list, then press the **ENTER** button. The selected title will be played back.

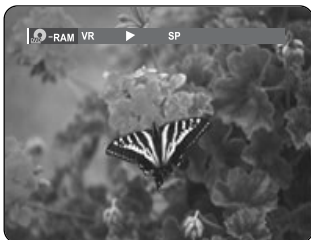

- 5** Press the **STOP** button to stop playing. To return the title list screen, press the **TITLE LIST** button.



Note

- You can also play a recorded program by pressing the **ANYKEY** button.



- Press the ▲▼ buttons to select **Title**.
- Press the ◀▶ buttons to select to play the title list, then press the **ENTER** button.

## Title List Screen Elements

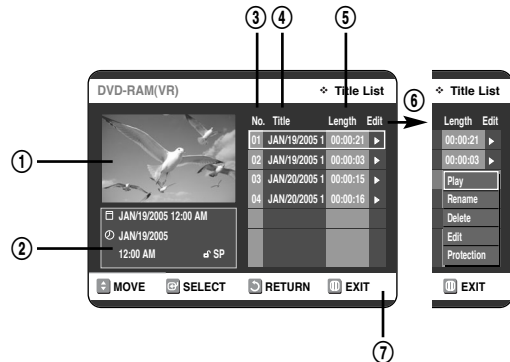

- 1 Playback screen for recorded titles.
- 2 Information window for the selected title: Title name, recording date, recording time, lock status, recording mode
- 3 Recorded title No.
- 4 Recorded title name
- 5 Recording Length (i.e., the playing time)
- 6 Edit menu
  - Play: Plays the selected title.
  - Rename: Renames the title of a selected title.
  - Delete: Deletes the selected title from the list.
  - Edit: Deletes a section of title.
  - Protection: Locks or unlocks the selected title.
- 7 Button display.



Note

- This may depend on the disc type.
- DVD-R/DVD-RW(Video) has limited editing function.



# Basic Editing (Title List)

## Renaming(Labeling) a Title

Follow these instructions to rename a title list name, i.e., to edit the title of a recorded program.



- 1 Press the **TITLE LIST** button.  
The Title List screen is displayed.

Using the **MENU** button.

- Press the **MENU** button.
- Press the **▲▼** buttons to select **Title List**, then press the **ENTER** or **▶** button twice.

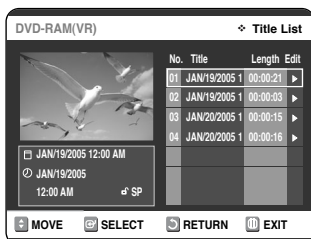

- 2 Press the **▲▼** buttons to select a title you want to rename from the Title List, then press the **ENTER** or **▶** button.

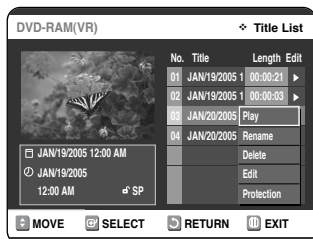

- 3 Press the **▲▼** buttons to select **Rename**, then press the **ENTER** or **▶** button.  
The Rename screen is displayed.

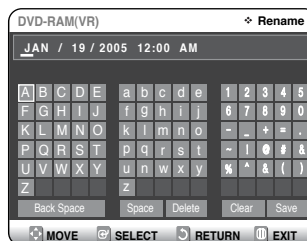
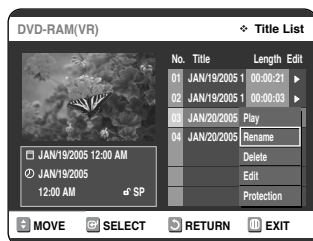

- 4 Select the desired characters using the **▲▼◀▶** buttons, press the **ENTER** button.

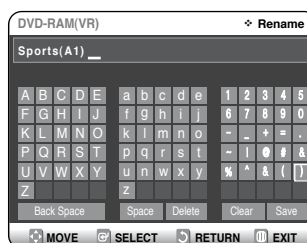

- **Back Space:** Moves the cursor one position backwards.(Equivalent to the **CLEAR** button)
- **Space:** Enters a blank and moves the cursor one forward (to the right).
- **Delete:** Deletes the character at the cursor position.
- **Clear:** Deletes all the character inputs.
- **Save:** Registers the character inputs.

- 5 Press the **▲▼◀▶** buttons to select **Save**, and then press the **ENTER** button.  
The changed title name is displayed in the title field of the selected title.

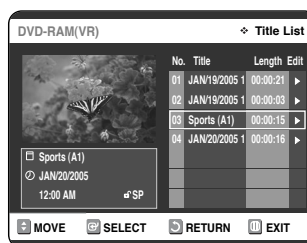

## Locking(Protecting) a Title

Follow these instructions to lock a title to protect it from accidental deletion.



- 1 Press the **TITLE LIST** button.  
The Title List screen is displayed.

Using the **MENU** button.

- Press the **MENU** button.
- Press the **▲▼** buttons to select **Title List**, then press the **ENTER** or **▶** button twice.

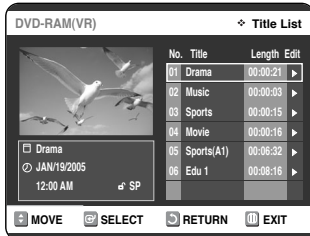

- 2 Press the **▲▼** buttons to select a title you want to protect in the Title List, then press the **ENTER** or **▶** button.

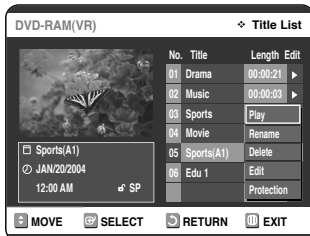

- 3 Press the **▲▼** buttons to select **Protection**, then press the **ENTER** or **▶** button.

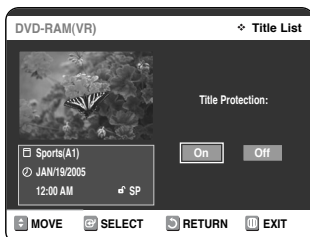
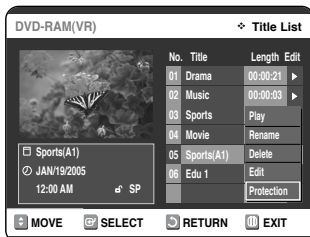

- 4 Press the **◀▶** buttons to select **On**, then press the **ENTER** button. The key icon on the information window for the selected title changes to the locked status. (🔒 → 🔒)

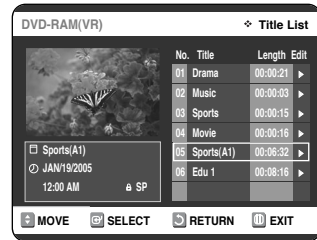

## Deleting a Title

Follow these instructions to delete a title from the Title List.



- 1 Press the **TITLE LIST** button.  
The Title List screen is displayed.

Using the **MENU** button.

- Press the **MENU** button.
- Press the **▲▼** buttons to select **Title List**, then press the **ENTER** or **▶** button twice.

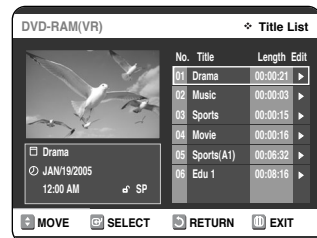

- 2 Press the **▲▼** buttons to select a title you want to delete in the Title List, then press the **ENTER** or **▶** button.

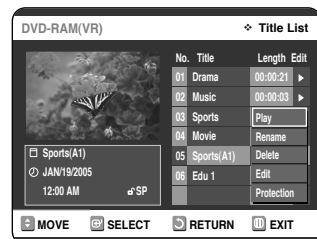

- 3** Press the ▲▼ buttons to select **Delete**, then press the **ENTER** or ► button.

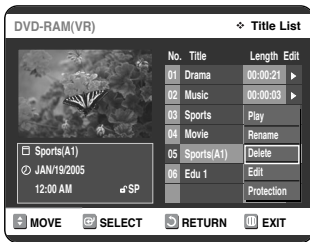

You will be prompted with a confirmation message.

DVD-RAM(VR), DVD-RW(VR mode): Since Playlist is present, the message 'Do you want to delete?(Related playlists may be deleted.)' is displayed.

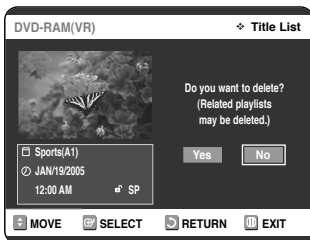

DVD-RW(Video mode), DVD-R: Since Playlist is not present, the message 'Do you want to delete?' is displayed.

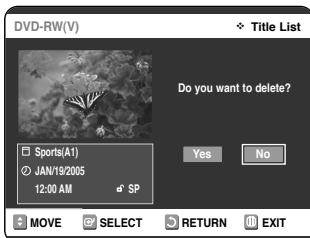

- The message may depend on the type of disc.

- 4** Press the ◀▶ buttons to select **Yes**, then press the **ENTER** button.



Note

- You cannot delete a protected title. If you want to delete a protected title, select **Off** in the Title Protection menu.
- Once a title is deleted from the Title List it cannot be recovered.
- Once DVD-R, DVD-RW is finalized, it cannot be deleted.
- With DVD-R, titles are only deleted from the menu, however, the Title remains physically on the disc.

## Deleting a Section of a Title

Follow these instructions to delete a section of a Title List title.



- 1** Press the **TITLE LIST** button. The Title List screen is displayed.

Using the **MENU** button.

- Press the **MENU** button.
- Press the ▲▼ buttons to select **Title List**, then press the **ENTER** or ► button twice.

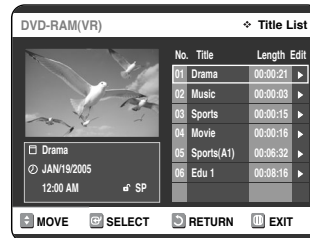

- 2** Press the ▲▼ buttons to select a title you want to delete from the Title List, then press the **ENTER** or ► button.

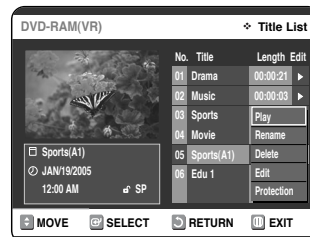

- 3** Press the ▲▼ buttons to select **Edit**, then press the **ENTER** or ► button. The Edit Title List screen is displayed.

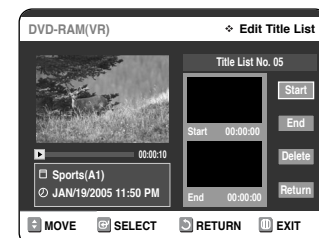

- 4** Press the **ENTER** button at the starting point.  
The image and starting point time are displayed in the section deletion starting point window.  
Edit Title List Screen Elements



- 1 Playback bar
  - 2 Playtime
  - 3 Section deletion starting point window and time
  - 4 Section deletion end point window and time
- Select the start and end points of the section you want to delete using the playback related buttons.
  - Playback related buttons:  
(▶,⏮,⏪,⏩,⏭).

- 5** Press the **ENTER** button at the end point.  
The image and end point time are displayed in the Section deletion ending point window.



- 6** Press the **▲▼** buttons to select **Delete**, then press the **ENTER** button.

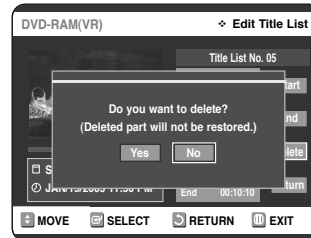
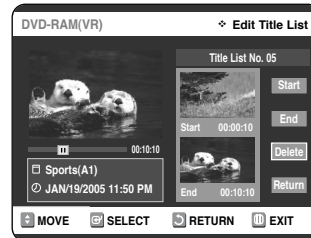

- 7** Press the **◀▶** buttons to select **YES**, then press the **ENTER** button.  
The selected section has been deleted.  
To return to the Title List screen, press the **▲▼** buttons to select Return.



Note

- The length of the section to be deleted must be at least 5 seconds long.
- If the length of the section to be deleted is less than 5 seconds, you will be prompted with the message 'The range is too short!'.
- If the end time precedes the starting time, you will be prompted with the message 'End point cannot be marked earlier than start point'.
- The section cannot be deleted when it includes a still picture.
- Press the **MENU** button after the operation has finished.  
The Title List screen will disappear.

# Advanced Editing (Playlist)

## Creating a Playlist

Follow these instructions to create a new playlist title from a recorded title.



**1** With the unit in Stop mode, press the **MENU** button.

**2** Press the **▲▼** buttons to select **Playlist**, then press the **ENTER** or **▶** button.

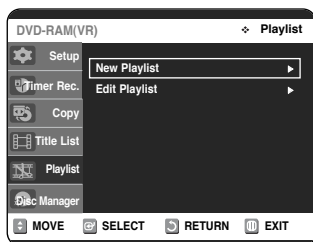

**3** Press the **▲▼** buttons to select **New Playlist**, then press the **ENTER** or **▶** button. The Make Scene screen is displayed.

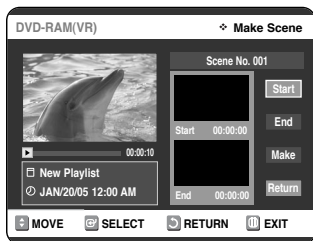

**4** Press the **ENTER** button at the start point.

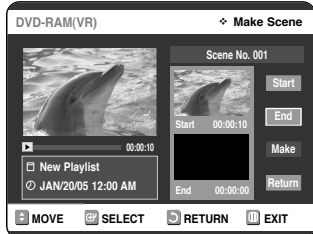

- The image and time at the start point are displayed on the Start window.
- The yellow-colored selection bar moves to the End item.
- Select the starting point of the section from which you want to create a new scene using the playback related buttons (**▶||I◀◀▶▶I.◀◀▶▶**).

**5** Press the **ENTER** button at the end point.

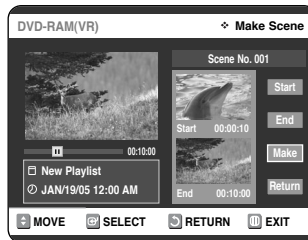

- The image and end point time are displayed in the End window.
- The yellow-colored selection bar moves to the Make icon.

- To make a new playlist -

**6** Press the **▲▼** buttons to select **Make**, then press the **ENTER** button. A new Make Scene screen is displayed. Repeat the above steps to create further scenes. A new Scene will be added to the current Playlist.



- You can check and see all the scenes on Edit Playlist screen.

Note

- To return to Edit Playlist menu -

**7** Press the **▲▼** buttons to select **Return**, then press the **ENTER** button. The Edit Playlist screen is displayed.

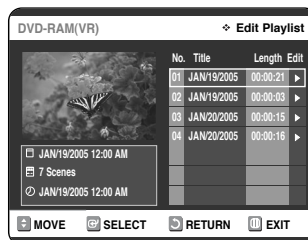

**8** Press the **MENU** or **PLAY LIST** button after the operation has finished. The Edit Playlist screen will disappear.



- You can create up to 99 playlist titles.
- Depending on the kind of disc, the displayed screen may have a slight difference.

Note

## Playing Titles in the Playlist

Follow these instructions to play the playlist titles.



- 1 Press the **PLAY LIST** button.  
The Edit Playlist screen is displayed.

Using the **MENU** button.

- Press the **MENU** button with the disc stopped.
- Press the **▲▼** buttons to select **Playlist**, then press the **ENTER** or **▶** button.
- Press the **▲▼** buttons to select **Edit Playlist**, then press the **ENTER** or **▶** button.

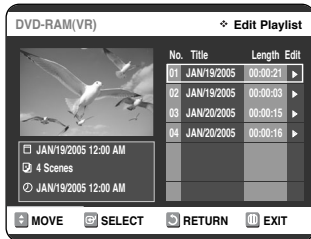
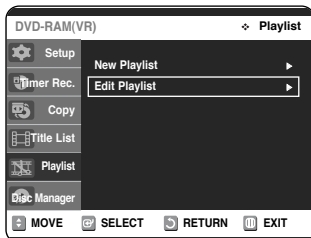

- 2 Press the **▲▼** buttons to select the title you want to play from the Playlist, then press the **ENTER** or **▶** button.

The Edit Playlist menu is displayed : Play, Rename, Edit Screen, Copy, Delete.

- 3 Press the **▲▼** buttons to select **Play**, then press the **ENTER** button.

The playlist titles will be played back.

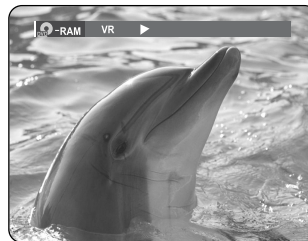
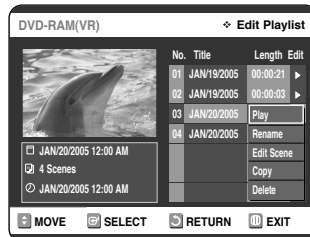

- 4 Press the **STOP** button to stop playing.  
The screen returns to the Edit Playlist screen.

## Renaming a Playlist Title

Follow these instructions to rename a playlist title, i.e. to edit the title of a playlist title.



- 1 Press the **PLAY LIST** button.  
The Edit Playlist screen is displayed.

Using the **MENU** button.

- Press the **MENU** button with the disc stopped.
- Press the **▲▼** buttons to select **Playlist**, then press the **ENTER** or **▶** button.
- Press the **▲▼** buttons to select **Edit Playlist**, then press the **ENTER** or **▶** button.

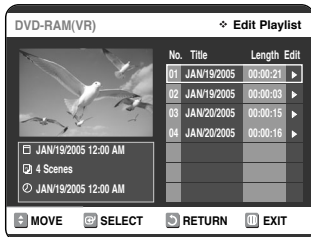

- 2 Press the **▲▼** buttons to select the title you want to rename from the Playlist, then press the **ENTER** or **▶** button.  
The Edit menu is displayed :Play, Rename, Edit Scene, Copy, Delete

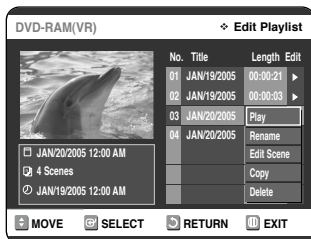

- 3 Press the **▲▼** buttons to select **Rename**, then press the **ENTER** button.  
The Rename screen is displayed.

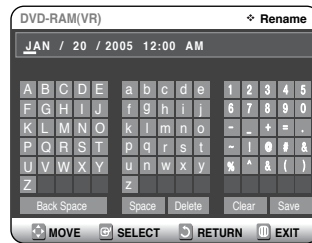
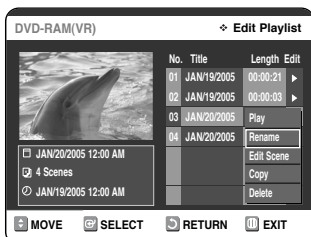

- 4 Enter the desired characters using the **▲▼◀▶** buttons.

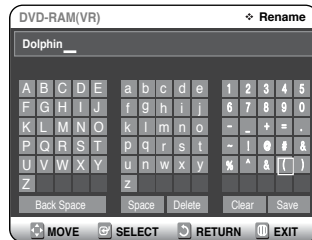

- This function is the same as the Rename function in renaming the title list. (See page 65.)
- The maximum number of characters that can be entered is 31.

- 5 Press the **▲▼◀▶** buttons to select **Save**, then press the **ENTER** button.  
The changed title is displayed in the title field of the selected title.

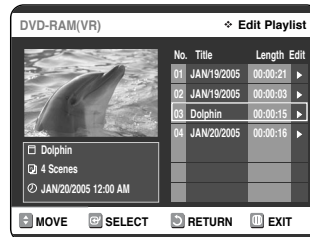

## Editing a Scene for the Playlist

Follow these instructions to edit scenes for a playlist.



- 1 Press the **PLAY LIST** button.  
The Edit Playlist screen is displayed.

Using the **MENU** button.

- Press the **MENU** button with the disc stopped.
- Press the **▲▼** buttons to select **Playlist**, then press the **ENTER** or **▶** button.
- Press the **▲▼** buttons to select **Edit Playlist**, then press the **ENTER** or **▶** button.

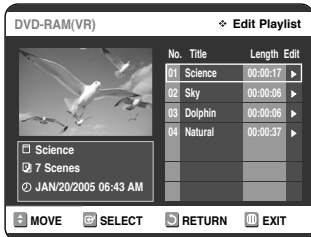

- 2 Press the **▲▼** buttons to select the title you want to edit from the Playlist, and then press the **ENTER** or **▶** button.  
The Edit Playlist menu is displayed: Play, Rename, Edit Scene, Copy, Delete

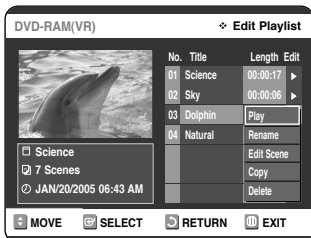

- 3 Press the **▲▼** buttons to select **Edit Scene**, then press the **ENTER** button.  
The Edit Scene screen is displayed.

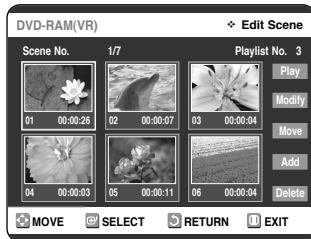
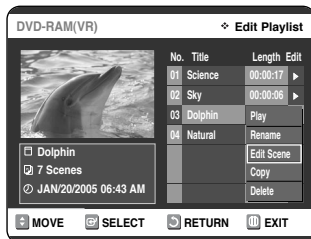

### Playing a Selected Scene

- 4 Press the **▲▼◀▶** buttons to select the scene you want to play, then press the **ENTER** button.  
The playlist title to be played is selected.

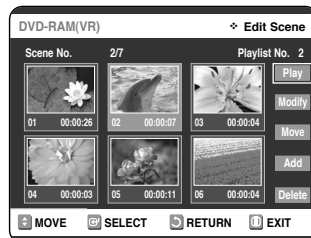

- 5 Press the **ENTER** button.  
The selected scene will be played back.



- To stop scene play, press the **STOP** button.



## Modifying a Scene (Replacing a Scene)

To setup, follow steps 1 to 3 in page 72.

- 4 Press the **▲▼◀▶** buttons to select the scene you want to modify, then press the **ENTER** button.

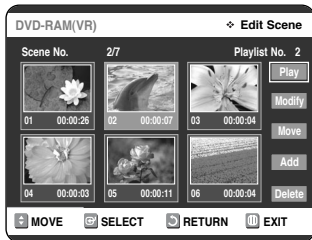

- 5 Press the **▲▼** buttons to select **Modify**, then press the **ENTER** button. The Modify Scene screen is displayed.

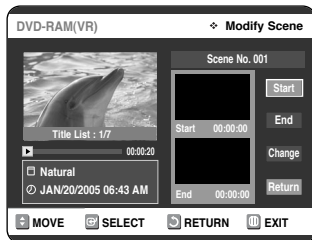

- 6 Press the **ENTER** button at the start point of the scene.

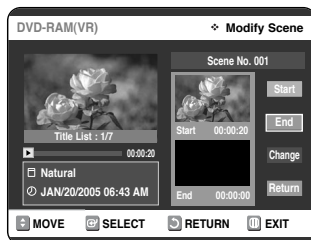

- The image and starting point time are displayed on the Start window.
- Select the starting or ending point of the section you want to modify using the playback related buttons (**▶II,I◀◀,▶▶I,◀◀▶▶**).

- 7 Press the **ENTER** button at the end point of the scene.



- The image and ending point time are displayed in the End window.

- 8 Press the **▲▼** buttons to select **Change**, then press the **ENTER** button.

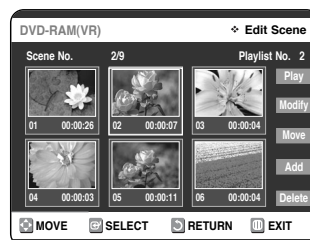

- The scene you want to modify is changed with the selected section.

## Moving a Scene (Changing the Position of a Scene)

To setup, follow steps 1 to 3 in page 72.

- 4 Press the ▲▼◀▶ buttons to select the scene you want to move (change the position), then press the **ENTER** button.

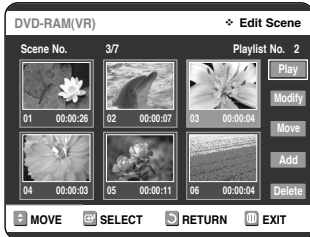

- 5 Press the ▲▼ buttons to select **Move**, then press the **ENTER** button.

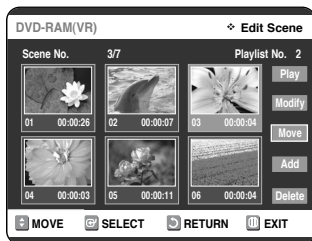

- A yellow selection window is displayed on the scene to be moved.

- 6 Press the ▲▼◀▶ buttons to select the position to which you want to move the selected scene, then select the **ENTER** button.

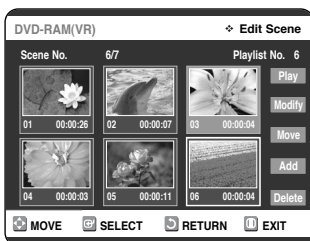

- The selected scene is moved to the selected position.

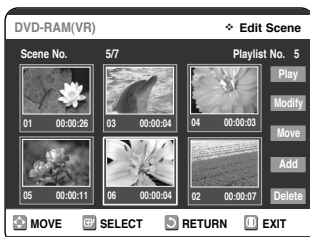

Note

- You cannot move the selected scene to the position of the next scene, because the selected scene should be inserted before that position, which requires no action.
- Depending on the kind of disc, the displayed screen may have a slight difference.

## Adding a Scene

To setup, follow steps 1 to 3 in page 72.

- 4 Press the ▲▼◀▶ buttons to select the scene that will have a new scene inserted before it, then press the **ENTER** button. A yellow selection window is displayed on the scene to be added as the new scene.

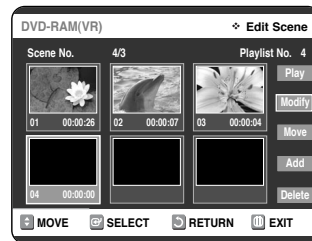

- 5 Press the ▲▼ buttons to select **add**, then press the **ENTER** button. The Add Scene screen is displayed.

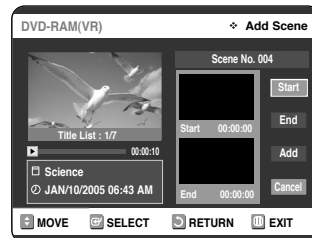

- 6 Press the **ENTER** button at the starting point of the scene.

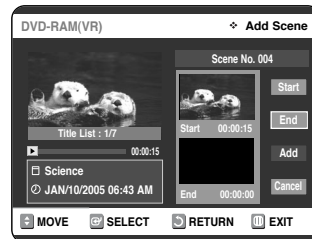

- The image and starting point time are displayed in the Start window.
- Select the end point of the section where you want to add the new scene using the playback related buttons (▶||◀◀▶▶I.◀◀▶▶).

- 7** Press the **ENTER** button at the end point of the scene.

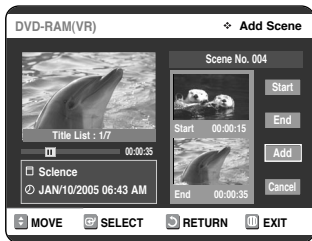

- The image and time of the end point are displayed in the End window.
- To cancel, press the **▲▼** buttons to select **Cancel** and then press the **ENTER** button.

- 8** Press the **▲▼** buttons to select **Add**, then press the **ENTER** button.

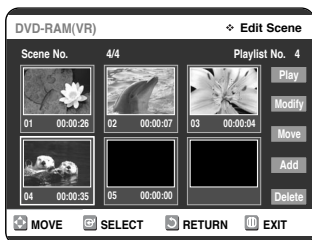

- The section you want to add is inserted prior to the scene selected in step 4 of Adding a Scene on the previous page.

## Deleting a Scene

To setup, follow steps 1 to 3 in page 72.

- 4** Press the **▲▼◀▶** buttons to select the scene you want to delete, and then press the **ENTER** button.

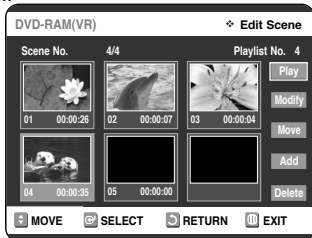

- 5** Press the **▲▼** buttons to select **Delete**, then press the **ENTER** button.

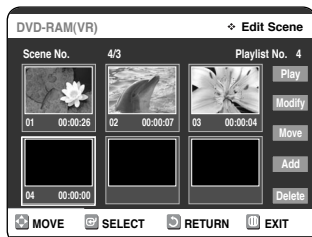

## Copying a Playlist Title to the VCR

- 1** Press the **PLAY LIST** button.  
The Edit Playlist screen is displayed.

Using the **MENU** button.

- Press the **MENU** button with the disc stopped.
- Press the **▲▼** buttons to select **Playlist**, and then press the **ENTER** or **▶** button.
- Press the **▲▼** buttons to select **Edit Playlist**, and then press the **ENTER** or **▶** button.

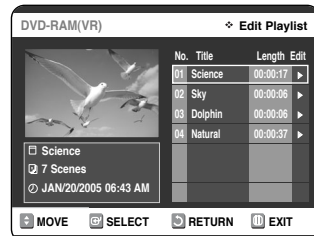

- 2** Press the **▲▼** buttons to select the title you want to copy to the VCR, and then press the **ENTER** or **▶** button.

The Edit Playlist menu is displayed: Play, Rename, Edit Scene, Copy, Delete.

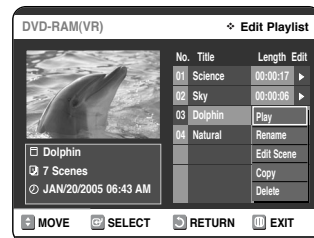

- 3** Press the **▲▼** buttons to select **Copy**, then press the **ENTER** button.

- The title you choose is played and copied to VCR tape.

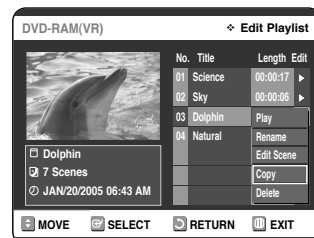

- 4** Press the **MENU** button after the operation has finished. The menu screen will disappear.



- The playlist can contain up to 99 playlist titles (titles).

## Deleting a Playlist Title from the Playlist

- 1 Press the **PLAY LIST** button.  
The Edit Playlist screen is displayed.

Using the **MENU** button.

- Press the **MENU** button with the disc stopped.
- Press the **▲▼** buttons to select **Playlist**, then press the **ENTER** or **▶** button.
- Press the **▲▼** buttons to select **Edit Playlist**, then press the **ENTER** or **▶** button.

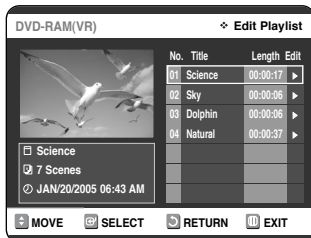

- 2 Press the **▲▼** buttons to select the title you want to delete from the Playlist, then press the **ENTER** or **▶** button.  
The Edit Playlist menu is displayed: Play, Rename, Edit Scene, Copy, Delete

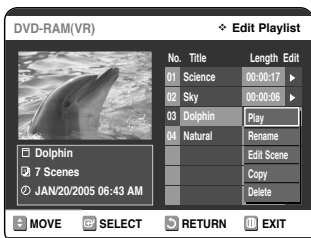

- 3 Press the **▲▼** buttons to select **Delete**, then press the **ENTER** button.

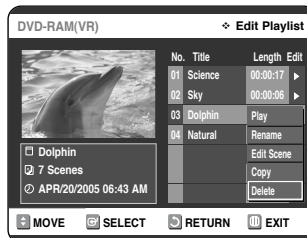

- You will be prompted with the delete confirmation message 'Do you want to delete?.'

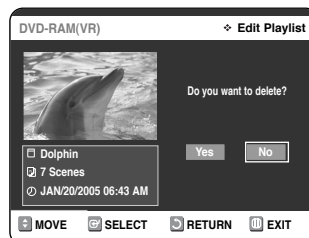

- 4 Press the **◀▶** buttons to select **Yes**, then press the **ENTER** button.  
It automatically returned to the Edit Playlist screen after the delete operation has finished.

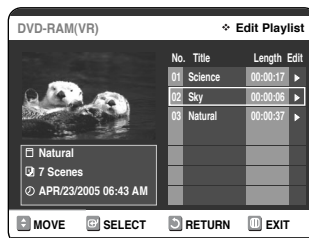
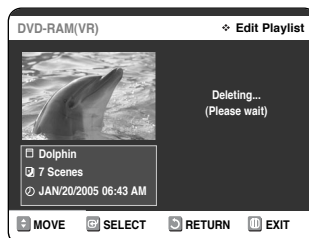

# Disc Manager

## Editing the Disc Name

Follow these instructions to give a name to a disc.



- 1 With the unit in Stop mode, press the **MENU** button.

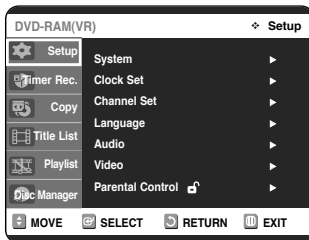

- 2 Press the **▲▼** buttons to select **Disc Manager**, then press the **ENTER** or **▶** button.

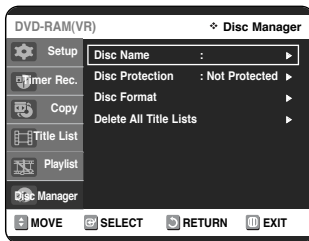

- 3 Press the **▲▼** buttons to select **Disc Name**, then press the **ENTER** or **▶** button. The Edit Name screen is displayed.

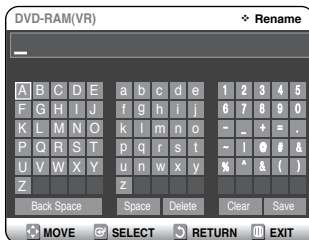

- 4 Enter the desired characters using the **▲▼◀▶** buttons.

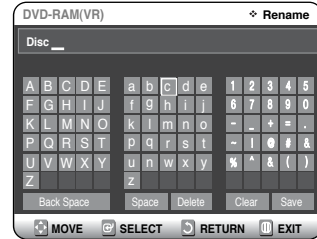

- This function is the same as the Rename function in renaming the title list. (See page 65.)
- The maximum number of characters that can be entered is 31.

- 5 Press the **▲▼◀▶** buttons to select **Save**, then press the **ENTER** button. A disc name is given to the disc.

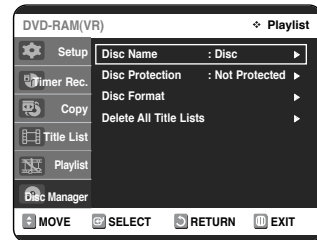

Note

- You may need to clear disc protection before beginning editing. (see page 78)
- Depending on the kind of disc, the displayed screen may be different.

## Disc Protection

Disc Protect allows you to protect your discs from being formatted or deleted due to unintended operations.



- 1 With the unit in Stop mode, press the **MENU** button.

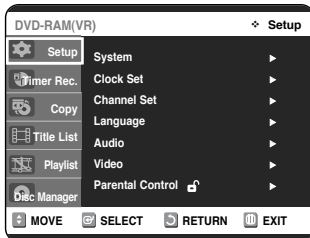

- 2 Press the **▲▼** buttons to select **Disc Manager**, then press the **ENTER** or **▶** button.

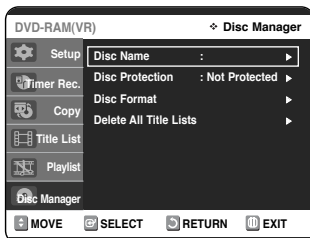

- 3 Press the **▲▼** buttons to select **Disc Protection**, then press the **ENTER** or **▶** button.

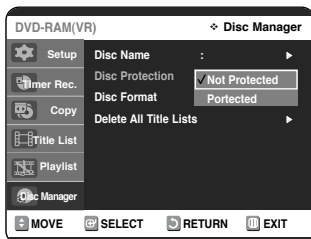

- 4 Press the **▲▼** button to select **Protected**, then press the **ENTER** or **▶** button.

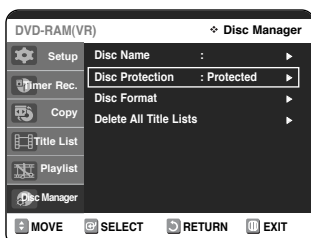

## Formatting a Disc

Use these instructions to format a disc. The disc protect should be cleared



- 1 With the unit in Stop mode, press the **MENU** button.

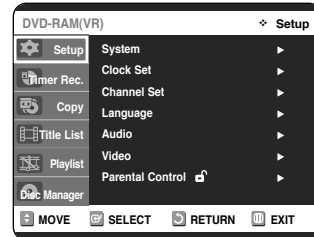

- 2 Press the **▲▼** buttons to select **Disc Manager**, then press the **ENTER** or **▶** button.

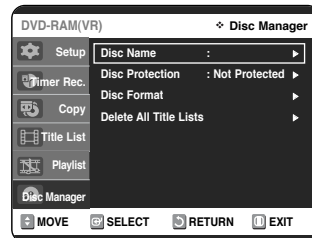

- 3 Press the **▲▼** buttons to select **Disc Format**, then press the **ENTER** or **▶** button.

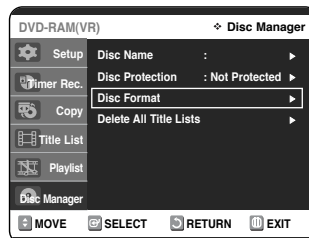

### DVD-RAM

- You will be prompted with the confirmation message 'Do you want to format disc?'

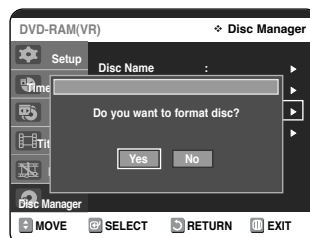

- You will be prompted with the confirmation message 'All data will be deleted. Do you want to continue?'

## DVD-RW

- You will be prompted with the confirmation message 'Choose the recording format for DVD- RW.'

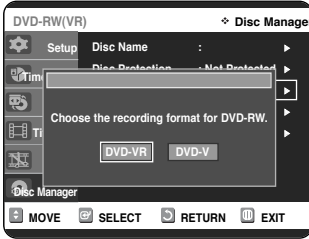

- Press the ◀▶ buttons to select **Yes**, then press the **ENTER** button. The disc is formatted.

**DVD-VR and DVD-V are defined according to their recording format.**

	DVD-VR	DVD-V
DISC	DVD-RAM DVD-RW	DVD-RW DVD-R

## Finalizing a disc

After you record titles onto a DVD-RW/DVD-R disc with your DVD Recorder & VCR, it needs to be finalized before it can be played back on external devices.



- With the unit in Stop mode, press the **MENU** button.

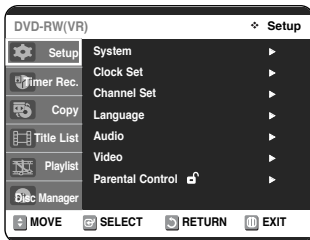

- Press the ▲▼ buttons to select **Disc Manager**, then press the **ENTER** or ▶ button.

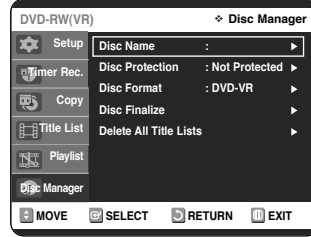

- Press the ▲▼ button to select **Disc Finalize**, then press the **ENTER** or ▶

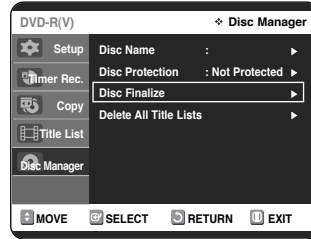
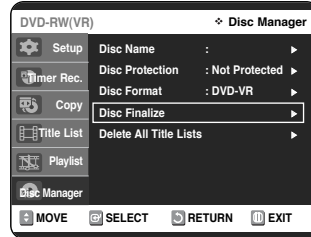

You will be prompted with the message 'Do you want to finalize disc?'. If you select Yes, you will be prompted again with the message 'Disc will be finalized. Do you want to continue?'

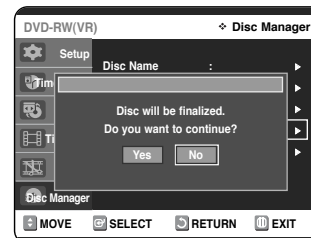
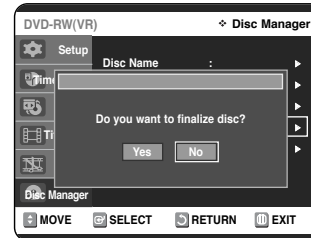

**4** Press the ◀▶ buttons to select **Yes**, then press the **ENTER** button.

The disc is finalized.



Note

- Once a disc is finalized, you cannot delete titles from the record list.
- After being finalized, the DVD-R/DVD-RW(video mode) operates in the same manner as a DVD-Video.
- Depending on the disc type, the displayed screen may be different .
- Finalizing time may be different depending on the amount of data recorded on the disc.
- Data on the disc will be damaged if the recorder is powered off during finalize process.

## Delete All Title Lists



**1** With the unit in Stop mode, press the **MENU** button.

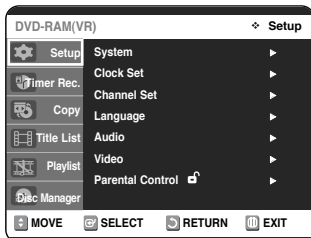

**2** Press the ▲▼ buttons to select **Disc Manager**, then press the **ENTER** or ▶ button.

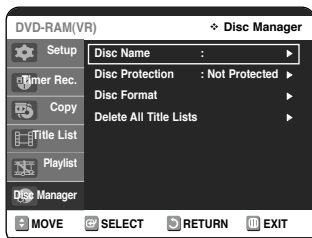

**3** Press the ▲▼ button to select **Delete All Title Lists**, then press the **ENTER** or ▶ button.

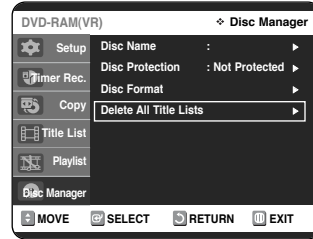

- You will be prompted with the confirmation message 'Do you want to delete all title lists?'.



- When Protected Title exists: The Delete All Title List function will not operate. If there is a title containing a still picture, however, that function will not operate. If you want to delete a protected title, disable Protect for it on the Lock item.

**4** Press the ◀▶ buttons to select **Yes**, then press the **ENTER** button.  
All title lists are deleted.



## Unfinalizing a disc (V/VR mode)



- 1 With the unit in Stop mode, press the **MENU** button.

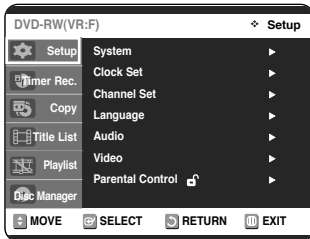

- 2 Press the **▲▼** buttons to select **Disc Manager**, then press the **ENTER** or **▶** button.

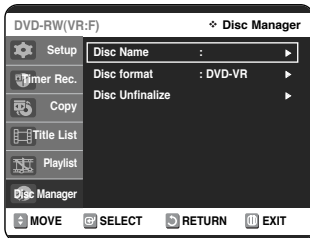

- 3 Press the **▲▼** button to select **Disc Unfinalize**, then press the **ENTER** or **▶** button. You will be prompted with the message 'Do you want to unfinalize disc?'.



If you select Yes, you will be prompted again with the message 'Disc will be unfinalized. Do you want to continue?'

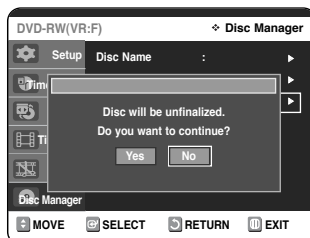

- 4 Press the **◀▶** buttons to select **Yes**, then press the **ENTER** button. The disc is unfinalized.



Note

- A DVD-RW can be finalized or unfinalized in Video mode.

	Finalize	Unfinalize
Mark	DVD-Video(RW)	DVD-RW(V)
Operation	Same as DVD-Video	Additional recording, protection and deletion are possible.

- A DVD-RW can be finalized or unfinalized in VR mode.

	Finalize	Unfinalize
Mark	DVD-RW(VR:F)	DVD-RW(VR)
Operation	Additional recording, deletion, editing, and protection are impossible.	Additional recording, deletion, editing, and protection are possible.



# Reference

*Troubleshooting* .....83  
*Specifications* .....86

**Troubleshooting**



**Specifications**



**LIMITED WARRANTY TO ORIGINAL PURCHASER**

# Troubleshooting

## (DVD-VIDEO/DVD-RAM/DVD-RW/DVD-R)



If your product malfunctions, go through the check points below before contacting a Samsung authorized service center,

Problem	Explanation/Solution
<b>No power.</b>	<ul style="list-style-type: none"> <li>• Check whether the power cord is securely plugged into the power outlet.</li> <li>• Did you press the power button of your DVD Recorder &amp; VCR.</li> </ul>
<b>The input is displayed for a while when the power turns on.</b>	<ul style="list-style-type: none"> <li>• The DVD Recorder &amp; VCR requires some time to initialize after it is turned on.</li> </ul>
<b>Cannot record TV programs.</b>	<ul style="list-style-type: none"> <li>• Check whether the power cord is securely plugged into the power outlet.</li> <li>• Did you set the DVD Recorder &amp; VCR channel settings correctly?</li> <li>• Check the free space on your DVD-RAM/DVD-RW/DVD-R disc.</li> <li>• Check the antenna cable is connected.</li> </ul>
<b>Timer recording does not work properly.</b>	<ul style="list-style-type: none"> <li>• Check the recording time, end time and current time settings again.</li> <li>• Recording will be cancelled if the power is interrupted due to a power failure or other reason during recording.</li> </ul>
<b>Cannot record.</b>	<ul style="list-style-type: none"> <li>• Check whether the disc is formatted. This product can record on formatted discs only. (See page 78.)</li> <li>• Check whether your DVD-RAM/DVD-RW/DVD-R disc has a sufficient free space.</li> </ul>
<b>I pressed the REC button but there is no response.</b>	<ul style="list-style-type: none"> <li>• Recording is available on DVD-RAM/DVD-RW/DVD-R discs only.</li> <li>• If a program is copy protected, you cannot record it.</li> </ul>
<b>I forget the password for parental lock.</b>	<ul style="list-style-type: none"> <li>• Press the ► and ►► buttons of your DVD Recorder &amp; VCR at the same time when the power is on, and then press the <b>POWER OFF/ON</b> button. All settings including password will revert to factory settings. Do not use it if not absolutely required. (Note that this function is available only when there is no disc inserted.)</li> </ul>
<b>Cannot playback the disc.</b>	<ul style="list-style-type: none"> <li>• Check whether the disc is inserted correctly with the label facing up.</li> <li>• Check the regional code of your DVD disc.</li> <li>• This DVD Recorder &amp; VCR cannot playback some types of disc. (See page 5.)</li> </ul>
<b>No sound.</b>	<ul style="list-style-type: none"> <li>• Are you watching a program in slow or skip mode? If you are playing a program at a speed other than normal speed, sound is not output.</li> <li>• Check the connections and initial settings.</li> <li>• Check whether the disc is damaged. Clean up the disc, if necessary.</li> <li>• Check whether the disc is inserted correctly with the label facing up.</li> </ul>

# Troubleshooting(DVD)



Problem	Explanation/Solution
<b>⊗ icon appears on the screen.</b>	You cannot use the operation or function due to one of the following reasons: (1) Your DVD disc does not support the feature (for example, angles) (2) You've requested a title, chapter, or scan time that is out of the correct range.
<b>Play mode settings are different from the settings configured with the Setting menu.</b>	The disc does not support all the selected functions. In this case, some settings you configure on the Setting menu may not work properly.
<b>Cannot change the aspect ratio.</b>	Aspect ratio is fixed for DVD disc.
<b>No audio output.</b>	Check whether you selected correct digital output options in the Audio Output Options menu.
<b>No video or audio output. The disc tray is ejected after 2 to 5 seconds.</b>	Did you move your DVD Recorder & VCR suddenly from a cold place to a warm place? In this case, remove discs and wait for one to two hours with the power on, and then, insert the disc and try to playback again. It will work properly when condensation has evaporated.
<b>Angle operation does not work during playback of a DVD disc.</b>	Angle operation is available only when the disc contains images captured at different angles.
<b>The disc revolves, but no image or bad quality images are output.</b>	<ul style="list-style-type: none"><li>• Check whether there is damage or foreign materials on your disc.</li><li>• Some discs with bad manufacturing quality may not be played back.</li><li>• If the scene changes from dark to bright suddenly, the screen may jitter temporarily, but it is not a defect.</li></ul>
<b>Desired sound language and subtitle language are not played.</b>	Sound languages and subtitle languages are disc-specific. Only the sound and subtitle languages contained on a DVD disc are available and displayed on the disc menu.
<b>No progressive output.</b>	<ul style="list-style-type: none"><li>• Check whether PSO is displayed on front panel.</li><li>• Make sure to change the component video output using the Progressive button when the disc is stopped.</li></ul>
<b>The remote control doesn't work.</b>	<ul style="list-style-type: none"><li>• Point the remote control at the remote control sensor on your DVD Recorder &amp; VCR. Operate within distance. (15ft) Remove obstacles between your DVD Recorder &amp; VCR and remote control.</li><li>• Check whether the batteries are depleted.</li></ul>
<b>Other problems</b>	<ul style="list-style-type: none"><li>• Read the table of contents and then find and read the sections describing your problem, and follow the directions given.</li><li>• Turn the unit off and on.</li><li>• If your problem still persists, contact your nearest Samsung service center.</li></ul>

# Troubleshooting(VCR)



Before contacting a Samsung authorized service center, perform the following simple checks.

Problem	Explanation/Solution
No power	<ul style="list-style-type: none"><li>• Check that the power plug is connected to a wall outlet.</li><li>• Have you pressed the <b>POWER</b> button?</li></ul>
You cannot insert a video cassette	<ul style="list-style-type: none"><li>• A video cassette can only be inserted with the window side up and the safety tab facing you.</li></ul>
The television program was not recorded	<ul style="list-style-type: none"><li>• Check the DVD Recorder &amp; VCR antenna connections.</li><li>• Is the DVD Recorder &amp; VCR tuner properly set?</li><li>• Check if the safety tab is intact on the cassette.</li></ul>
Timer recording was unsuccessful	<ul style="list-style-type: none"><li>• Re-check the recording start/stop time settings and the current time</li><li>• Check whether you insert a tape which has enough time record</li></ul>
No playback picture or the picture is distorted	<ul style="list-style-type: none"><li>• Check to see if you are using a prerecorded tape.</li></ul>
You cannot see normal broadcasts	<ul style="list-style-type: none"><li>• Check the tuner/external setting. It should be on tuner.</li><li>• Check the TV antenna connections.</li></ul>
Noise bars or streaks on playback	<ul style="list-style-type: none"><li>• Press the CH/TRK (▲/▼) buttons to minimize this effect.</li></ul>
When the ►   button is pressed during playback, the still picture has severe “noise bar” streaks	<ul style="list-style-type: none"><li>• A still picture may have “noise bars”, depending on the condition of the tape. Press the CH/TRK (▲/▼) buttons during slow motion to minimize this effect.</li></ul>
Video Head Cleaning	<ul style="list-style-type: none"><li>• If poor pictures appear on a variety of cassettes, the video heads may need cleaning. This is not a common problem and unless it appears, the heads should not be cleaned. When cleaning the video heads, read all instructions provided with the head cleaning cassette. Incorrect head cleaning can permanently damage the video heads.</li></ul>

If you are unable to solve the problem after reading the above instructions, note:

- **The model and serial number on the rear of your DVD Recorder & VCR**
- **The warranty information**
- **A clear description of the problem**

Then contact your nearest SAMSUNG authorized service center.

# Specifications



<b>General</b>	Power requirements	120V AC, 60Hz
	Power consumption	45 Watts
	Weight	9.03 lb
	Dimensions	16.9 in(W) x 12.6 in(D) x 3.3 in(H)
	Operating temp.	+41°F to +95°F
	Other conditions	Keep level when operating. Less than 75% operating humidity
<b>Input</b>	Video	1.0 V p-p at 75Ω load, sync negative S-Video input (Y: 1.0Vp-p, C: 0.286Vp-p at 75Ω load)
	Max. Audio Input Level	2Vrms
	DV Input	IEEE 1394(4p) compatible jack
	Receivable Channels	Regular TV broadcasting: VHF (2~13), UHF (14~69) Cable TV broadcasting: 1~125
<b>Output</b>	Audio	Audio output jacks 1, 2 Optical/Coaxial digital audio output support Min. 100 dB signal-to-noise ratio Max. 0.005% total harmonic distortion (T.H.D) at average 1 KHz
	Video	Video output jacks 1 S-Video output 1 (Y:1.0Vp-p, C:0.286Vp-p at 75Ω load) Component output (Y: 1.0Vp-p, Pb: 0.70Vp-p, Pr: 0.70Vp-p at 75Ω load)
<b>DVD</b>	Picture Compression format	MPEG-II
	Audio Compression format	Dolby AC-3 256kbps
	Recording Quality	XP (about 8 Mbps), SP (about 4 Mbps), LP (about 2 Mbps), EP (about 1.2 Mbps)
	Video S/N Ratio	Min. 50dB at standard recording
	Audio S/N Ratio	Min. 75dB
	Audio frequency characteristics	20 Hz ~ 20 KHz

## Audio Output

For DVD discs, audio signals recorded at 96kHz sampling frequency are converted into and output at 48kHz.

Disc Type	DVD	AUDIO CD(CD-DA)
Analog Audio Output	48 / 96KHz	44.1KHz
Digital Audio Output	48KHz	44.1KHz

# SAMSUNG DVD RECORDER & VCR

## LIMITED WARRANTY TO ORIGINAL PURCHASER

This SAMSUNG brand product, as supplied and distributed by Samsung Electronics America, Inc. (SAMSUNG) and delivered new, in the original carton to the original consumer purchaser, is warranted by SAMSUNG against manufacturing defects in materials and workmanship for a limited warranty period of:

### **One (1) Year Parts / Ninety (90) days Labor (90 days Parts and Labor for Commercial Use)**

This limited warranty begins on the original date of purchase, and is valid only on products purchased and used in the United States. To receive warranty service, the purchaser must contact SAMSUNG for problem determination and service procedures. Warranty service can only be performed by a SAMSUNG authorized service center. The original dated bill of sale must be presented upon request as proof of purchase to SAMSUNG or SAMSUNG's authorized service center. Transportation of the product to and from the service center is the responsibility of the purchaser.

SAMSUNG will repair or replace this product, at our option and at no charge as stipulated herein, with new or reconditioned parts or products if found to be defective during the limited warranty period specified above. All replaced parts and products become the property of SAMSUNG and must be returned to SAMSUNG. Replacement parts and products assume the remaining original warranty, or ninety (90) days, whichever is longer.

SAMSUNG's obligations with respect to software products distributed by SAMSUNG under the SAMSUNG brand name are set forth in the applicable end user license agreement. Non-SAMSUNG hardware and software products, if provided, are on an "AS IS" basis. Non-SAMSUNG manufacturers, suppliers, publishers, and service providers may provide their own warranties.

This limited warranty covers manufacturing defects in materials and workmanship encountered in normal, and except to the extent otherwise expressly provided for in this statement, noncommercial use of this product, and shall not apply to the following, including, but not limited to: damage which occurs in shipment; delivery and installation; applications and uses for which this product was not intended; altered product or serial numbers; cosmetic damage or exterior finish; accidents, abuse, neglect, fire, water, lightning or other acts of nature; use of products, equipment, systems, utilities, services, parts, supplies, accessories, applications, installations, repairs, external wiring or connectors not supplied and authorized by SAMSUNG, or which damage this product or result in service problems; incorrect electrical line voltage, fluctuations and surges; customer adjustments and failure to follow operating instructions, cleaning, maintenance and environmental instructions that are covered and prescribed in the instruction book; product removal or reinstallation; reception problems and distortion related to noise, echo, interference or other signal transmission and delivery problems. SAMSUNG does not warrant uninterrupted or error-free operation of the product.

THERE ARE NO EXPRESS WARRANTIES OTHER THAN THOSE LISTED AND DESCRIBED ABOVE, AND NO WARRANTIES WHETHER EXPRESS OR IMPLIED, INCLUDING, BUT NOT LIMITED TO, ANY IMPLIED WARRANTIES OF MERCHANTABILITY OR FITNESS FOR A PARTICULAR PURPOSE, SHALL APPLY AFTER THE EXPRESS WARRANTY PERIODS STATED ABOVE, AND NO OTHER EXPRESS WARRANTY OR GUARANTY GIVEN BY ANY PERSON, FIRM OR CORPORATION WITH RESPECT TO THIS PRODUCT SHALL BE BINDING ON SAMSUNG. SAMSUNG SHALL NOT BE LIABLE FOR LOSS OF REVENUE OR PROFITS, FAILURE TO REALIZE SAVINGS OR OTHER BENEFITS, OR ANY OTHER SPECIAL, INCIDENTAL OR CONSEQUENTIAL DAMAGES CAUSED BY THE USE, MISUSE OR INABILITY TO USE THIS PRODUCT, REGARDLESS OF THE LEGAL THEORY ON WHICH THE CLAIM IS BASED, AND EVEN IF SAMSUNG HAS BEEN ADVISED OF THE POSSIBILITY OF SUCH DAMAGES. NOR SHALL RECOVERY OF ANY KIND AGAINST SAMSUNG BE GREATER IN AMOUNT THAN THE PURCHASE PRICE OF THE PRODUCT SOLD BY SAMSUNG AND CAUSING THE ALLEGED DAMAGE. WITHOUT LIMITING THE FOREGOING, PURCHASER ASSUMES ALL RISK AND LIABILITY FOR LOSS, DAMAGE OR INJURY TO PURCHASER AND PURCHASER'S PROPERTY AND TO OTHERS AND THEIR PROPERTY ARISING OUT OF THE USE, MISUSE OR INABILITY TO USE THIS PRODUCT SOLD BY SAMSUNG NOT CAUSED DIRECTLY BY THE NEGLIGENCE OF SAMSUNG. THIS LIMITED WARRANTY SHALL NOT EXTEND TO ANYONE OTHER THAN THE ORIGINAL PURCHASER OF THIS PRODUCT, IS NONTRANSFERABLE AND STATES YOUR EXCLUSIVE REMEDY.

Some states do not allow limitations on how long an implied warranty lasts, or the exclusion or limitation of incidental or consequential damages, so the above limitations or exclusions may not apply to you. This warranty gives you specific legal rights, and you may also have other rights which vary from state to state.

To obtain warranty hardware service, please contact SAMSUNG at:

SAMSUNG CUSTOMER CARE CENTER  
400 Valley Road, Suite 201, Mt. Arlington, NJ 07856  
**1-800-SAMSUNG (1-800-726-7864) and [WWW.SAMSUNG.com](http://WWW.SAMSUNG.com)**



**ELECTRONICS**

**SAMSUNG ELECTRONICS AMERICA, INC.**

**HEADQUARTERS**

105 Challenger Road, Ridgefield Park, N.J.

07660-0511

TEL: 1-800-SAMSUNG

**SERVICE DIVISION**

400 Valley Road, Suite 201, Mount Arlington, NJ 07856

1-800-SAMSUNG (1-800-726-7864)

[www.samsung.com](http://www.samsung.com)

AK68-00588A-00



## Free Manuals Download Website

<http://myh66.com>

<http://usermanuals.us>

<http://www.somanuals.com>

<http://www.4manuals.cc>

<http://www.manual-lib.com>

<http://www.404manual.com>

<http://www.luxmanual.com>

<http://aubethermostatmanual.com>

Golf course search by state

<http://golfingnear.com>

Email search by domain

<http://emailbydomain.com>

Auto manuals search

<http://auto.somanuals.com>

TV manuals search

<http://tv.somanuals.com>