

# Quick Start Manual

## Guide de prise en main rapide

### PL150/PL151



For more information, refer to the User Manual included on the supplied **CD-ROM**.

Pour des instructions plus détaillées, veuillez consulter le mode d'emploi complet sur le **CD-ROM** fourni avec l'appareil.

This Quick Start Manual has been specially designed to guide you through the basic functions and features of your device. Please read the Quick Start Manual and User Manual carefully to ensure safe and correct use.

Ce guide de prise en main rapide a été spécialement conçu pour vous permettre de découvrir les fonctions et caractéristiques de base de votre appareil. Afin de garantir une utilisation sûre et correcte, lisez attentivement le guide de prise en main rapide et le mode d'emploi.

ENG / SPA / FRE

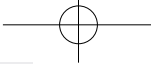

# Contents



Health and safety information	2	1
Camera layout .....	4	13
Setting up your camera .....	5	12
Unpacking .....	5	
Inserting the battery and memory card .....	6	
Charging the battery .....	6	
Turning on your camera.....	7	
Selecting options .....	7	
Capturing photos or videos	8	28
Playing files .....	9	61
Transferring files to a PC (Windows) .....	10	77
Specifications .....	11	99

# Health and safety information



## Warnings

### Do not use your camera near flammable or explosive gases and liquids

Do not use your camera near fuels, combustibles, or flammable chemicals. Do not store or carry flammable liquids, gases, or explosive materials in the same compartment as the camera or its accessories.

### Keep your camera away from small children and pets

Keep your camera and all accessories out of the reach of small children and animals. Small parts may cause choking or serious injury if swallowed. Moving parts and accessories may present physical dangers as well.

### Prevent damage to subjects' eyesight

Do not use the flash in close proximity (closer than 1 m/3 ft) to people or animals. Using the flash too close to your subject's eyes can cause temporary or permanent damage.

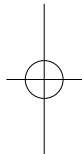

### Handle and dispose of batteries and chargers with care

- Use only Samsung-approved batteries and chargers. Incompatible batteries and chargers can cause serious injuries or damage to your camera.
- Never place batteries or cameras on or in heating devices, such as microwave ovens, stoves, or radiators. Batteries may explode when overheated.



### Handle and store your camera carefully and sensibly

- Do not allow your camera to get wet—liquids can cause serious damage. Do not handle your camera with wet hands. Water damage to your camera can void your manufacturer's warranty.
- Avoid using or storing your camera in dusty, dirty, humid, or poorly-ventilated areas to prevent damage to moving parts and internal components.

- Exercise caution when connecting cables or adapters and installing batteries and memory cards. Forcing the connectors, improperly connecting cables, or improperly installing batteries and memory cards can damage ports, connectors, and accessories.
- Do not insert foreign objects into any of your camera's compartments, slots, or access points. This type of damage may not be covered by your warranty.

### Protect batteries, chargers, and memory cards from damage

- Avoid exposing batteries or memory cards to very cold or very hot temperatures (below 0° C/32° F or above 40° C/104° F). Extreme temperatures can reduce the charging capacity of your batteries and can cause memory cards to malfunction.
- Prevent memory cards from making contact with liquids, dirt, or foreign substances. If dirty, wipe the memory card clean with a soft cloth before inserting in your camera.

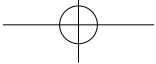

## Camera layout

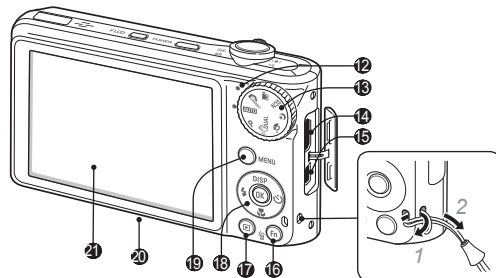
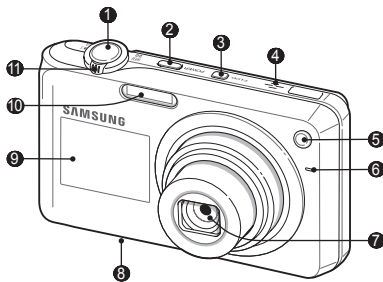

- ① Shutter button
- ② POWER button
- ③ Front LCD button
- ④ Speaker
- ⑤ AF-assist light/timer lamp
- ⑥ Microphone
- ⑦ Lens
- ⑧ Battery chamber cover
- ⑨ Front display
- ⑩ Flash
- ⑪ Zoom button

- ⑫ Status lamp
- ⑬ Mode dial
- ⑭ USB and A/V port (Accepts USB cable or A/V cable)
- ⑮ HDMI port (Accepts HDMI cable)
- ⑯ Function button
- ⑰ Playback button
- ⑱ Navigation button/OK button
- ⑲ MENU button
- ⑳ Tripod mount
- ㉑ Main display

4



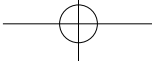

# Setting up your camera

## Unpacking

English

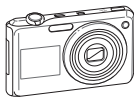

Camera



AC adapter/USB cable



Rechargeable battery



Strap

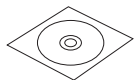

User Manual CD-ROM



Quick Start Manual

### Optional accessories



Camera case



Memory card  
(microSD™)



A/V cable

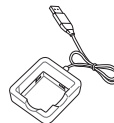

Battery charger

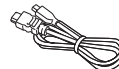

HDMI cable

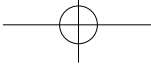

## Setting up your camera

### Inserting the battery and memory card

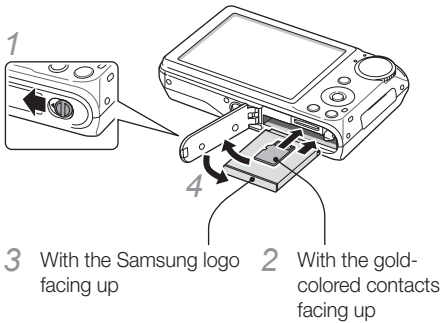

#### ▼ Removing the battery

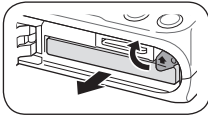

#### ▼ Removing the memory card

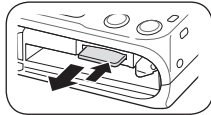

Push gently until the card disengages from the camera and then pull it out of the slot.

6

### Charging the battery

Before using the camera for the first time, you must charge the battery.

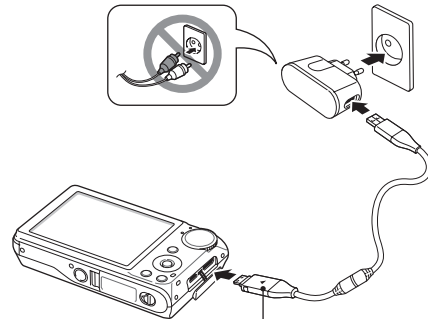

#### Indicator light

- Red: Charging
- Green: Fully charged

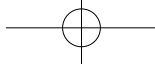

## Turning on your camera

- 1 Press **[POWER]**.
  - The initial setup screen appears when you turn on your camera for the first time.

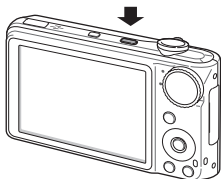

- 2 Select a language, set the date and time, and select a time zone.

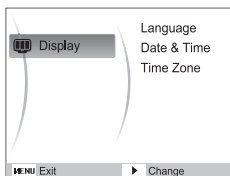

## Selecting options

- 1 In Shooting mode, press **[MENU]**.
- 2 Use the navigation buttons to scroll to an option or menu.

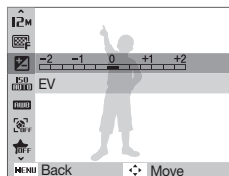

- 3 Press **[OK]** to confirm the highlighted option or menu.
    - To move left or right, press **[←]** or **[→]**.
    - To move up or down, press **[DISP]** or **[↓]**.
- 2 Press **[OK]** to confirm the highlighted option or menu.
    - Press **[MENU]** again to go back to the previous menu.

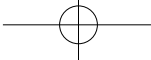

## Capturing photos or videos

### Taking a photo

- 1 Rotate the mode dial to **AUTO**.
- 2 Align your subject in the frame.
- 3 Press **[Shutter]** halfway down to focus automatically.
  - A green frame means the subject in focus.

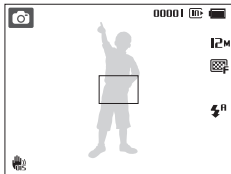

- 4 Press **[Shutter]** all the way down to take the photo.

### Taking a photo of yourself using the front display

The front display will help you take self-portraits.

- 1 In Shooting mode, press **[Front LCD]** once.
  - The front display turns on in the Self-portrait mode.

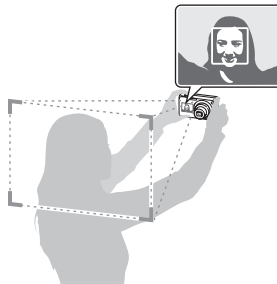

- 2 Press **[Shutter]** halfway down to focus.
- 3 Press **[Shutter]** all the way down to take the photo.



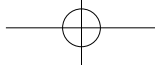









## Recording a video

- 1 Rotate the mode dial to .
- 2 Align your subject in the frame.
- 3 Press **[Shutter]**.
  - Press **[OK]** to pause or resume.
- 4 Press **[Shutter]** again to stop the recording.



Note

### Number of photos by resolution (for 1 GB microSD™)

	Resolution	Super Fine	Fine	Normal
	4000 X 3000	145	281	399
	3984 X 2656	166	310	436
	3840 X 2160	200	363	522
	3264 X 2448	209	370	531
	2560 X 1920	335	560	783
	2048 X 1536	526	793	1,053
	1920 X 1080	860	1,131	1,421
	1024 X 768	1,455	1,651	1,851

These figures are measured under Samsung's standard conditions and may vary depending on shooting conditions and camera settings.



## Playing files

### Viewing photos

- 1 Press **[▶]**.
- 2 Press **[⏮]** or **[⏪]** to scroll through files.
  - Press and hold to scroll through files quickly.

### Viewing videos

- 1 Press **[▶]**.
- 2 Press **[OK]**.
- 3 Use the following buttons to control playback.

	Scan backward
<b>[OK]</b>	Pause or resume playback
	Scan forward
<b>[Zoom]</b> left or right	Adjust the volume level

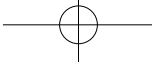

## Transferring files to a PC (Windows)

- 1 Connect the camera to your computer with the USB cable.

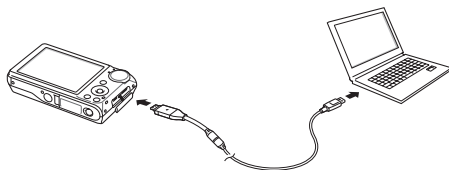

### Note

Make sure that the **PC Software** option is set to **On** in the settings menu.

- 2 Turn on the camera.
  - The computer recognizes the camera automatically.
  - For Windows Vista, select **Run iStudio.exe** from the AutoPlay window.
- 3 Select a folder on your computer to save new files.
  - If your camera has no new files, the pop-up window for saving new files will not appear.

- 4 Select **Yes**.
  - New files will be transferred to your computer. You can now use the Intelli-studio program.

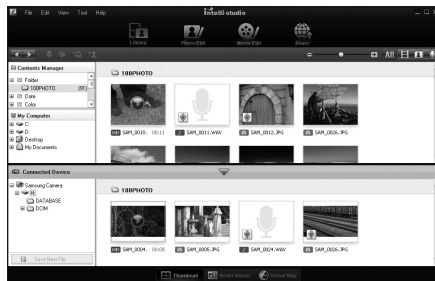

### Note

#### About Intelli-studio

Intelli-studio is a built-in program that allows you to play back and edit files. You can also upload files to websites, such as Flickr or YouTube.

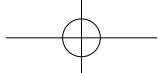

## Specifications

Image sensor	<ul style="list-style-type: none"> <li>Type: 1/2.33" (approx. 7.79 mm) CCD</li> <li>Effective pixels: approx. 12.4 mega-pixels</li> <li>Total pixels: approx. 12.7 mega-pixels</li> </ul>
Lens	<ul style="list-style-type: none"> <li>Focal length: Samsung lens f = 4.9 - 24.5 mm (35 mm film equivalent: 27 - 135 mm)</li> <li>F-stop range: F3.5 (W) - F5.9 (T)</li> </ul>
Display	<ul style="list-style-type: none"> <li>Main Display: 3.0" (approx. 7.6 cm) QVGA (230 K)</li> <li>Front Display: 1.5" (approx. 3.8 cm) 61 K TFT LCD</li> </ul>
Focusing	TTL auto focus (Multi AF, Center AF, Face Detection AF, Tracking AF, Smart Face Recognition AF)
Shutter speed	<ul style="list-style-type: none"> <li>Auto: 1/8 - 1/2,000 sec.</li> <li>Program: 1 - 1/2,000 sec.</li> <li>Night: 8 - 1/2,000 sec.</li> <li>Fireworks: 2 sec.</li> </ul>
Storage	<ul style="list-style-type: none"> <li>Internal memory: approx. 30 MB</li> <li>External memory (Optional): microSD™ card (up to 2 GB guaranteed), microSDHC™ card (up to 8 GB guaranteed)</li> </ul> <p>Internal memory capacity may not match these specifications.</p>
DC power input connector	20 pin
Rechargeable battery	Lithium-ion battery (SLB-07, 760 mAh)
Dimensions (W x H x D)	99.2 x 59 x 19.9 mm
Weight	136.6 g (without battery and memory card)
Operating temperature	0 - 40° C
Operating humidity	5 - 85 %

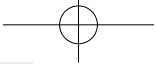

## Contenido

Información sobre salud y seguridad .....	2	1
Diseño de la cámara .....	4	13
Configuración de la cámara .....	5	12
Desembalaje .....	5	
Insertar la batería y la tarjeta de memoria .....	6	
Cargar la batería.....	6	
Encender la cámara .....	7	
Selección de opciones .....	7	
Captura de fotografías o vídeos.....	8	28
Reproducción de archivos ...	9	61
Transferencia de archivos a un ordenador (para Windows) ...	10	77
Especificaciones .....	11	99



## Información sobre salud y seguridad



### Advertencias

#### No utilice la cámara cerca de líquidos y gases explosivos o inflamables

No utilice la cámara cerca de carburantes, combustibles o sustancias químicas inflamables. No almacene ni transporte líquidos inflamables, gases o materiales explosivos en el mismo compartimento en el que están la cámara o los accesorios.

#### Mantenga la cámara alejada del alcance de los niños y las mascotas

Mantenga la cámara y todos los accesorios fuera del alcance de los niños y los animales. Es posible que se traguen las piezas más pequeñas y, como consecuencia, se asfixien o sufran graves lesiones. Los accesorios y las piezas móviles también pueden causar daños físicos.

#### Evite dañar la vista del sujeto

No utilice el flash si está a una proximidad inferior a 1m de las personas o los animales. Si utiliza el flash cuando está demasiado cerca de los ojos del sujeto, puede producirle daños temporales o permanentes.

ES-2

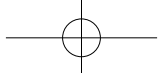

### Utilice y deseche las baterías y los cargadores con cuidado

- Utilice únicamente baterías y cargadores aprobados por Samsung. Las baterías y los cargadores incompatibles pueden producirle graves lesiones o causar daños a la cámara.
- Nunca coloque las baterías o las cámaras dentro de dispositivos conductores de calor, como hornos de microondas, estufas o radiadores, ni sobre ellos. Las baterías pueden explotar si se recalientan.



### Precauciones

### Utilice y guarde la cámara con cuidado y de manera prudente

- No permita que la cámara se moje, ya que los líquidos pueden causarle graves daños. No manipule la cámara si tiene las manos mojadas. Si se producen daños en la cámara a causa del agua, se puede anular la garantía del fabricante.
- No utilice ni guarde la cámara en áreas en las que haya polvo, suciedad, humedad o poca ventilación, a fin de evitar daños en las partes móviles o en los componentes internos.

- Tenga cuidado al conectar los cables y los adaptadores y al instalar las baterías y las tarjetas de memoria. Si ejerce demasiada fuerza sobre los conectores, conecta de manera inapropiada los cables o instala de manera inadecuada las baterías y las tarjetas de memoria, puede dañar los puertos, los conectores y los accesorios.
- No inserte objetos extraños en ningún compartimento, ranura o punto de acceso de la cámara. Es posible que la garantía no cubra este tipo de daños.

### Proteja las baterías, los cargadores y las tarjetas de memoria contra daños

- No exponga las baterías o las tarjetas de memoria a temperaturas demasiado bajas o demasiado altas (inferiores a 0 °C/32 °F o superiores a 40 °C/104 °F). Las temperaturas extremas pueden reducir la capacidad de carga de las baterías y generar un funcionamiento defectuoso de las tarjetas de memoria.
- Evite que las tarjetas de memoria entren en contacto con líquidos, suciedad o sustancias extrañas. Si la tarjeta de memoria se ensucia, límpiela con un paño suave antes de insertarla en la cámara.

ES-3

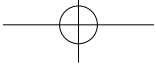

## Diseño de la cámara

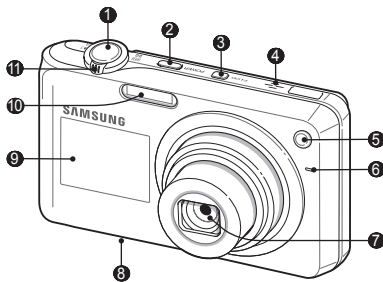

- 1 Botón del obturador
- 2 Botón de encendido y apagado
- 3 Botón LCD frontal
- 4 Altavoz
- 5 Luz AF auxiliary/luz de temporizador
- 6 Micrófono
- 7 Lente
- 8 Cubierta de la cámara de la batería
- 9 Pantalla frontal
- 10 Flash
- 11 Botón de zoom

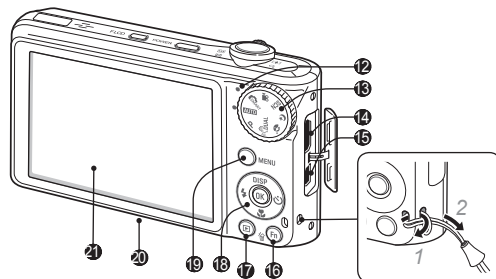

- 12 Luz indicadora de estado
- 13 Selector de modos
- 14 Puerto USB y A/V (Admite cable USB y cable A/V)
- 15 Puerto HDMI (Admite cable HDMI)
- 16 Botón de funciones
- 17 Botón de reproducción
- 18 Botón de navegación/botón OK
- 19 Botón de menú
- 20 Orificio para el montaje del trípode
- 21 Pantalla principal

ES-4



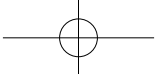

# Configuración de la cámara

## Desembalaje



Cámara



Fuente de alimentación/  
Cable USB



Batería recargable



Correa



CD-ROM del Manual del usuario



Manual de inicio rápido

## Accesorios opcionales



Estuche para la  
cámara



Tarjeta de memoria  
(microSD™)

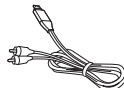

Cable A/V

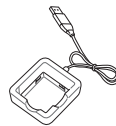

Cargador de la batería

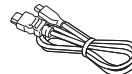

Cable HDMI

ES-5

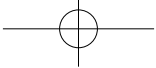

## Configuración de la cámara

### Insertar la batería y la tarjeta de memoria

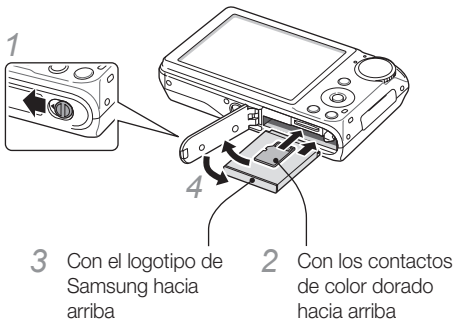

#### ▼ Quitar la batería

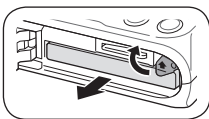

#### ▼ Quitar la tarjeta de memoria

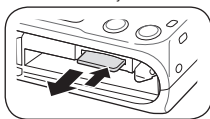

Ejerza una leve presión hasta que la tarjeta se desprenda de la cámara y, luego, retirela de la ranura.

### Cargar la batería

Cargue la pila antes de utilizar la cámara.

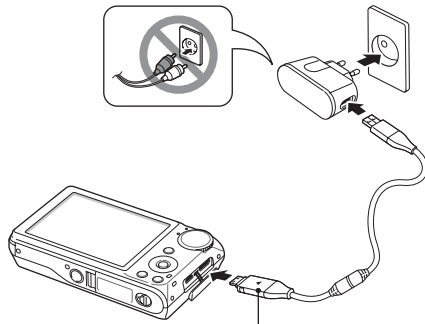

#### Luz indicadora

- Rojo: cargándose
- Verde: completamente cargada

ES-6



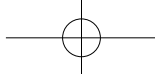

## Encender la cámara

- 1 Pulse **[POWER]**.
  - Cuando encienda la cámara por primera vez, aparecerá la pantalla de configuración inicial.

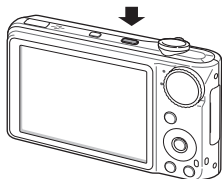

- 2 Seleccione el idioma, establezca la fecha y la hora, y seleccione una zona horaria.

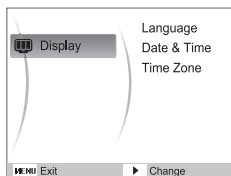

## Selección de opciones

- 1 En el modo de disparo, pulse **[MENU]**.
- 2 Utilice los botones de navegación para desplazarse hacia una opción o hacia un menú.

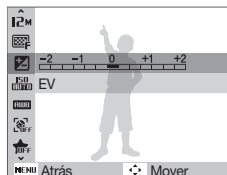

- 3 Pulse **[OK]** para confirmar la opción o el menú resaltados.
  - Para desplazarse hacia la izquierda o hacia la derecha, pulse **[←]** o **[→]**.
  - Para desplazarse hacia arriba o hacia abajo, pulse **[DISP]** o **[↓]**.

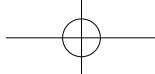

## Captura de fotografías o vídeos

### Tomar una fotografía

- 1 Gire el selector de modos hasta **AUTO**.
- 2 Alinee el sujeto en el marco.
- 3 Pulse **[Obturator]** hasta la mitad para utilizar el enfoque automático.
  - Si aparece un cuadro verde, significa que el sujeto está enfocado.

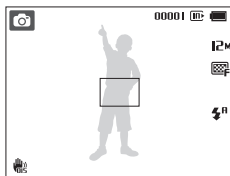

- 4 Pulse completamente **[Obturator]** para tomar la fotografía.

### Tomar un autorretrato con ayuda de la pantalla frontal

La pantalla frontal lo ayudará a realizar autorretratos.

- 1 En el modo de disparo, pulse el botón **[LCD frontal]** una vez.
  - La pantalla frontal se enciende en el modo Autorretrato.

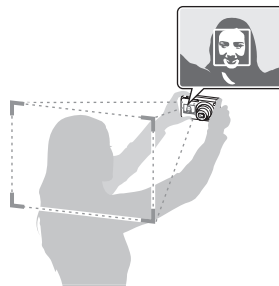

- 2 Pulse **[Obturator]** hasta la mitad para enfocar.
- 3 Pulse **[Obturator]** completamente para tomar la fotografía.

ES-8



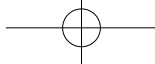









### Grabar un vídeo

- 1 Gire el selector de modos hasta .
- 2 Alinee el sujeto en el marco.
- 3 Pulse **[Obturador]**.
  - Pulse **[OK]** para pausar o reanudar.
- 4 Pulse **[Obturador]** nuevamente para detener la grabación.

#### Nota

#### Cantidad de fotografías por resolución



(para microSD™ de 1GB)

	Resolución	Superfina	Fina	Normal
	4000 X 3000	145	281	399
	3984 X 2656	166	310	436
	3840 X 2160	200	363	522
	3264 X 2448	209	370	531
	2560 X 1920	335	560	783
	2048 X 1536	526	793	1053
	1920 X 1080	860	1131	1421
	1024 X 768	1455	1651	1851

Estas son medidas tomadas en condiciones estándar, establecidas por Samsung, y pueden variar según las condiciones de disparo y la configuración de la cámara.



## Reproducción de archivos

### Ver fotografías

- 1 Pulse **[▶]**.
- 2 Pulse  o  para desplazarse por los archivos.
  - Mantenga la tecla pulsada para desplazarse por los archivos rápidamente.

### Ver vídeos

- 1 Pulse **[▶]**.
- 2 Pulse **[OK]**.
- 3 Utilice los siguientes botones para controlar la reproducción.

	Permite retroceder.
<b>[OK]</b>	Permite pausar o reanudar la reproducción.
	Permite avanzar.
<b>[Zoom]</b> hacia la izquierda o hacia la derecha	Permite ajustar el nivel de volumen.

ES-9

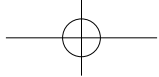

## Transferencia de archivos a un ordenador (para Windows)

- 1 Conecte la cámara a su ordenador con el cable USB.

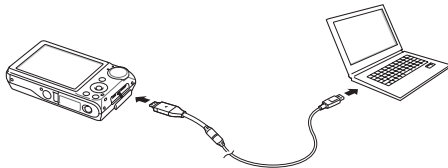

### Nota

Asegúrese de que la opción **Software del PC** esté configurada en **Encendido** en el menú de ajustes.

- 2 Encienda la cámara.
  - El ordenador reconoce la cámara automáticamente.
  - En Windows Vista, seleccione **Run iStudio.exe** en la ventana Reproducción automática.
- 3 Seleccione una carpeta en el ordenador para guardar los archivos nuevos.
  - Si su cámara no tiene archivos nuevos, no aparecerá la ventana emergente para guardar nuevos archivos.

- 4 Seleccione **Sí**.
  - Los archivos nuevos se transferirán al ordenador. Ahora puede utilizar el programa Intelli-studio.

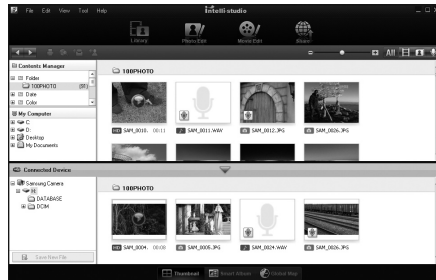

### Nota

#### Sobre Intelli-studio

Intelli-studio es un programa incorporado que le permite reproducir y editar archivos. Además, puede cargar archivos en sitios web, como Flickr o YouTube.

ES-10

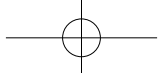

## Especificaciones

Sensor de imagen	<ul style="list-style-type: none"><li>• Tipo: 1/2,33" (aprox. 7,79 mm) CCD</li><li>• Píxeles reales: aprox. 12,4 megapíxeles</li><li>• Píxeles totales: aprox. 12,7 megapíxeles</li></ul>
Lente	<ul style="list-style-type: none"><li>• Distancia focal: Lente Samsung f = de 4,9 a 24,5 mm (equivalente en película de 35 mm: de 27 a 135 mm)</li><li>• Rango de apertura del objetivo: F3.5 (W) y F5.9 (T)</li></ul>
Pantalla	<ul style="list-style-type: none"><li>• Pantalla principal: 3,0" (aprox. 7,6 cm) QVGA (230 K)</li><li>• Pantalla frontal: LCD TFT de 1,5" (aprox. 3,8 cm) (61 K)</li></ul>
Enfoque	Enfoque automático TTL (Multi af, Af central, AF de detección de rostros, Estabilización AF, AF de reconocimiento de rostros inteligente)
Velocidad del obturador	<ul style="list-style-type: none"><li>• Auto: de 1/8 a 1/2000 s</li><li>• Programa: de 1 a 1/2000 s</li><li>• Nocturno: de 8 a 1/2000 s</li><li>• Fuegos Artificiales: 2 s</li></ul>
Almacenamiento	<ul style="list-style-type: none"><li>• Memoria interna: aprox. 30 MB</li><li>• Memoria externa (opcional): tarjeta microSD™ (hasta 2 GB garantizados), tarjeta SDHC™ (hasta 8 GB garantizados)</li></ul> <p>Es posible que la capacidad de la memoria interna no coincida con estas especificaciones.</p>
Conector de entrada de CC	20 pines
Batería recargable	Batería de litio (SLB-07, 760 mAh)
Dimensiones (alto x ancho x profundidad)	99,2 x 59 x 19,9 mm
Peso	136,6 g (sin la batería ni la tarjeta de memoria)
Temperatura de funcionamiento	De 0 °C a 40 °C
Humedad de funcionamiento	5 - 85 %

ES-11

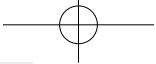

## Sommaire

Informations relatives à la santé et à la sécurité .....	2	1
Présentation de l'appareil photo .....	4	13
Assemblage de votre appareil photo .....	5	12
Contenu du coffret .....	5	
Insertion de la batterie et de la carte mémoire .....	6	
Chargement de la batterie.....	6	
Mise en route de l'appareil photo	7	
Sélection des options .....	7	
Prise de vues photo ou vidéo .....	8	28
Lecture de fichiers .....	9	61
Transfert de fichiers vers un PC (Windows) .....	10	77
Caractéristiques .....	11	99



## Informations relatives à la santé et à la sécurité



### Avertissements

#### **N'utilisez pas l'appareil photo à proximité de gaz et de liquides inflammables ou explosifs**

N'utilisez pas l'appareil à proximité de combustibles ou de produits chimiques inflammables. Ne transportez et ne stockez jamais de liquides inflammables, de gaz ou de matériaux explosifs dans le même emplacement que l'appareil ou ses accessoires.

#### **Ne laissez pas l'appareil photo à la portée d'enfants en bas âge et d'animaux domestiques**

Tenez l'appareil, ses pièces et ses accessoires, hors de portée des enfants en bas âge et des animaux. L'ingestion de petites pièces peut provoquer un étouffement ou des blessures graves. Les parties détachables et les accessoires représentent également un danger.

#### **Évitez d'endommager la vue des sujets photographiés**

N'utilisez pas le flash trop près (moins d'un mètre) des personnes et des animaux. L'utilisation du flash trop près des yeux du sujet peut provoquer des lésions temporaires ou permanentes.

FR-2

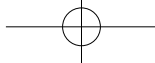

### Utilisez les batteries et les chargeurs avec précaution et respectez les consignes de recyclage

- Utilisez uniquement des batteries et des chargeurs Samsung. L'utilisation de batteries et de chargeurs incompatibles peut provoquer des blessures graves ou endommager votre appareil.
- Ne posez jamais les batteries ou l'appareil à l'intérieur ou au-dessus d'un dispositif chauffant, tel qu'un four à micro-ondes, une cuisinière ou un radiateur. En cas de surchauffe, les batteries risquent d'exploser.



#### Attention

### Manipulez et stockez votre appareil avec soins

- Évitez tout contact avec des liquides qui risqueraient d'endommager sérieusement votre appareil photo. N'utilisez pas l'appareil avec les mains mouillées. L'eau peut endommager votre appareil photo et entraîner l'annulation de la garantie du fabricant.
- Évitez d'utiliser et de stocker votre appareil dans un endroit poussiéreux, sale, humide ou mal ventilé afin de ne pas endommager ses composants internes.

- Lors du branchement des cordons et du chargeur et de l'insertion des batteries et des cartes mémoire, agissez prudemment. Enfoncer les cordons avec force ou sans précaution et insérer les batteries et les cartes mémoire de manière incorrecte peut endommager les prises et les accessoires.
- N'introduisez pas de corps étrangers dans les compartiments, les logements ou les ouvertures de l'appareil photo. Les dysfonctionnements qui s'en suivraient ne seront pas couverts par votre garantie.

### Protégez les batteries, les chargeurs et les cartes mémoire

- Évitez d'exposer les batteries et les cartes mémoire à des températures extrêmes (inférieures à 0 °C / 32 °F ou supérieures à 40 °C / 104 °F). Les températures extrêmes peuvent réduire les capacités de chargement des batteries et provoquer des dysfonctionnements des cartes mémoire.
- Évitez tout contact des cartes mémoire avec des liquides, de la poussière ou des corps étrangers. Si la carte mémoire est sale, nettoyez-la avec un chiffon doux avant de l'introduire dans l'appareil photo.

FR-3

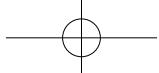

## Présentation de l'appareil photo

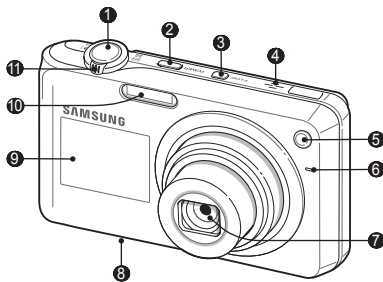

- 1 Déclencheur
- 2 Bouton de marche/arrêt
- 3 Bouton de l'écran LCD frontal
- 4 Haut-parleur
- 5 Voyant AF / Voyant du retardateur
- 6 Microphone
- 7 Objectif
- 8 Trappe batterie
- 9 Écran frontal
- 10 Flash
- 11 Touche zoom

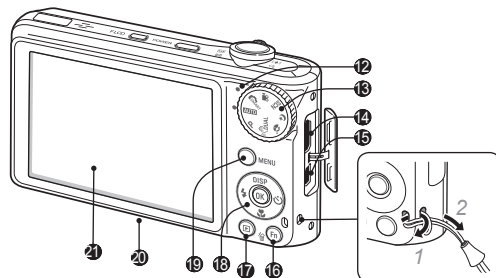

- 12 Voyant d'état
- 13 Molette de réglage
- 14 Port USB et port Audio/Vidéo (Compatible avec un câble USB ou un câble Audio/Vidéo)
- 15 Port HDMI (Compatible avec les câbles HDMI)
- 16 Touche Fonction
- 17 Touche Lecture
- 18 Touche Navigation / Touche OK
- 19 Touche Menu
- 20 Fixation du pied
- 21 Écran principal

FR-4





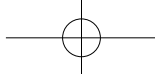

# Assemblage de votre appareil photo

## Contenu du coffret



Appareil photo



Adaptateur secteur /  
Câble USB



Batterie rechargeable



Dragonne



Mode d'emploi  
(CD-ROM)



Guide de démarrage rapide

Français

## Accessoires en option



Étui de l'appareil  
photo



Carte mémoire  
(microSD™)

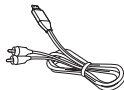

Câble Audio/Vidéo

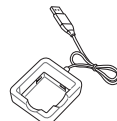

Chargeur de batterie

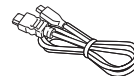

Câble HDMI

FR-5

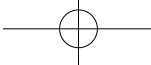

## Assemblage de votre appareil photo

### Insertion de la batterie et de la carte mémoire

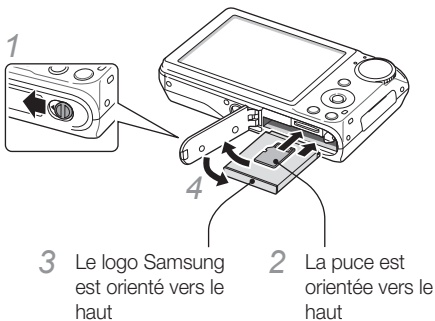

#### ▼ Retrait de la batterie

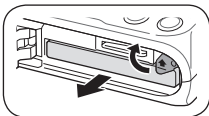

#### ▼ Retrait de la carte mémoire

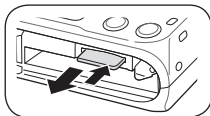

Poussez doucement jusqu'à faire sortir la carte de son logement, puis retirez-la entièrement.

FR-6

### Chargement de la batterie

Assurez-vous de charger la batterie avant d'utiliser l'appareil photo.

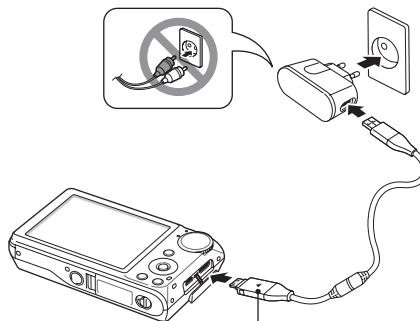

Voyant lumineux

- Rouge : en charge
- Vert : rechargé

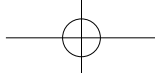

## Mise en route de l'appareil photo

- 1 Appuyez sur **[POWER]**.
  - L'écran de configuration initiale s'affiche lorsque vous allumez votre appareil photo pour la première fois.

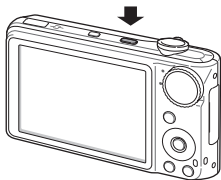

- 2 Sélectionnez une langue, réglez la date et l'heure et choisissez un fuseau horaire.

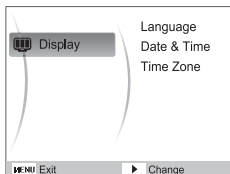

## Sélection des options

- 1 En mode Prise de vue, appuyez sur **[MENU]**.
- 2 Utilisez les touches de navigation pour atteindre une option ou un menu.

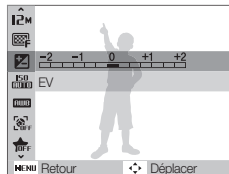

- Pour vous déplacer à gauche ou à droite, appuyez sur **[←]** ou **[→]**.
  - Pour vous déplacer en haut ou en bas, appuyez sur **[DISP]** ou **[↓]**.
- 3 Pour confirmer le menu ou l'option en surbrillance, appuyez sur **[OK]**.
    - Appuyez de nouveau sur **[MENU]** pour revenir au menu précédent.

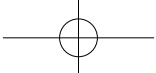

## Prise de vues photo ou vidéo

### Prise de vues

- 1 À l'aide de la molette de réglage, choisissez le mode **AUTO**.
- 2 Cadrez le sujet à photographier.
- 3 Appuyez à mi-course sur le déclencheur pour une mise au point automatique.
  - Un cadre vert signifie que le sujet est mis au point.

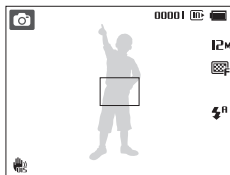

- 4 Appuyez à fond sur le déclencheur pour prendre la photo.

### Prenez une photo de vous-même en utilisant l'écran frontal

L'écran frontal vous permet de réaliser des autoportraits.

- 1 En mode Prise de vue, appuyez une fois sur **[Ecran LCD Frontal]**.
  - L'écran frontal bascule en mode Autoportrait.

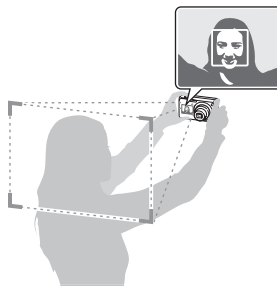

- 2 Appuyez à mi-chemin sur le déclencheur pour une mise au point automatique.
- 3 Appuyez à fond sur le déclencheur pour prendre la photo.

FR-8



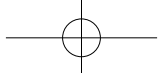

### Filmer une séquence vidéo

- 1 À l'aide de la molette de réglage, choisissez le mode .
- 2 Cadrez le sujet à photographier.
- 3 Appuyez sur le déclencheur.
  - Appuyez sur **[OK]** pour marquer une pause ou reprendre.
- 4 Appuyez de nouveau sur le déclencheur pour arrêter l'enregistrement.

### Remarque

#### Nombre de photos en fonction de la résolution

(pour une carte microSD™ de 1 Go)

Résolution	Maximale	Elevée	Normale	
<b>12M</b>	4000 X 3000	145	281	399
<b>10M</b>	3984 X 2656	166	310	436
<b>9M</b>	3840 X 2160	200	363	522
<b>8M</b>	3264 X 2448	209	370	531
<b>5M</b>	2560 X 1920	335	560	783
<b>3M</b>	2048 X 1536	526	793	1 053
<b>2M</b>	1920 X 1080	860	1 131	1 421
<b>1M</b>	1024 X 768	1 455	1 651	1 851

Ces chiffres proviennent des mesures effectuées par Samsung dans des conditions normales. Ils peuvent varier en fonction des paramètres et des conditions de prise de vue.

## Lecture de fichiers

### Visionner des photos

- 1 Appuyez sur **[▶]**.
- 2 Appuyez sur **[↶]** ou sur **[↷]** pour parcourir les fichiers.
  - Maintenez appuyé pour un défilement rapide des fichiers.

### Affichage des vidéos

- 1 Appuyez sur **[▶]**.
- 2 Appuyez sur **[OK]**.
- 3 Utilisez les touches suivantes pour contrôler la lecture.

<b>[↶]</b>	Retour arrière
<b>[OK]</b>	Mettre en pause ou reprendre après une pause
<b>[↷]</b>	Avance rapide
<b>[Zoom]</b> vers la gauche ou la droite	Réglage du niveau sonore

FR-9

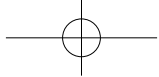

## Transfert de fichiers vers un PC (Windows)

- 1 Branchez l'appareil photo à l'ordinateur à l'aide du câble USB.

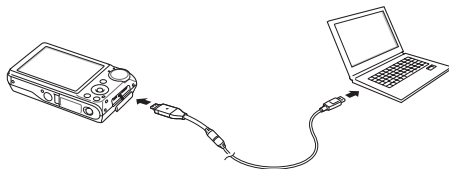

### Remarque

Vérifiez que l'option **Logiciel PC** est réglée sur **Marche** dans le menu des paramètres.

- 2 Allumez l'appareil photo.
  - L'ordinateur reconnaît l'appareil photo automatiquement.
  - Pour Windows Vista, sélectionnez **Run iStudio.exe** dans la fenêtre AutoPlay.
- 3 Sélectionnez un dossier sur votre ordinateur dans lequel vous allez enregistrer les nouveaux fichiers.
  - Si votre appareil photo est vide, la fenêtre de sauvegarde n'apparaîtra pas.

- 4 Sélectionnez **Oui**.
  - Les nouveaux fichiers seront transférés sur votre ordinateur. Vous pouvez à présent utiliser le programme Intelli-studio.

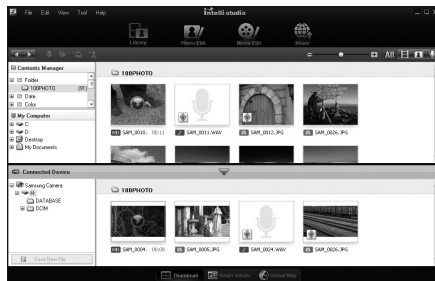

### Remarque

#### À propos d'Intelli-studio

Intelli-studio est un programme intégré qui vous permet de lire et de modifier des fichiers. Ce logiciel vous permet également de télécharger des fichiers vers des sites Web tels que Flickr ou YouTube.

FR-10

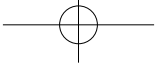

## Caractéristiques

Capteur d'images	<ul style="list-style-type: none"><li>Type : CCD 1/2,33" (environ 7,79 mm)</li><li>Pixels effectifs : environ 12,4 mégapixels</li><li>Nombre total de pixels : environ 12,7 mégapixels</li></ul>
Objectif	<ul style="list-style-type: none"><li>Distance focale : Objectif Samsung f = 4,9 - 24,5 mm (équivalent à un film 35 mm : 27 - 135 mm)</li><li>Plage d'ouverture de l'objectif : F3,5 (W) - F5,9 (T)</li></ul>
Écran	<ul style="list-style-type: none"><li>Écran principal : 3,0" (environ 7,6 cm) QVGA (230 000 pixels)</li><li>Écran frontal : LCD TFT 1,5" (3,8 cm) 61 000 pixels</li></ul>
Mise au point	Mise au point auto TTL (Mise au point multiple, Mise au point au centre, MAP détect. visage, Mise au point avec suivi, MAP Reconnaissance intelligente de visages)
Vitesse d'obturation	<ul style="list-style-type: none"><li>Automatique : 1/8 - 1/2 000 s.</li><li>Programme : 1 - 1/2 000 s.</li><li>Nuit : 8 - 1/2 000 s.</li><li>Feux d'artifice : 2 s.</li></ul>
Stockage	<ul style="list-style-type: none"><li>Mémoire interne : environ 30 Mo</li><li>Mémoire externe (en option) : Carte microSD™ (jusqu'à 2 Go garantis), Carte microSDHC™ (jusqu'à 8 Go garantis)</li></ul> <p>La capacité de la mémoire interne peut varier par rapport à ces caractéristiques.</p>
Connecteur d'alimentation CC	20 broches
Batterie rechargeable	Batterie lithium-ion (SLB-07, 760 mAh)
Dimensions (l x h x p)	99,2 x 59 x 19,9 mm
Poids	136,6 g (sans la batterie ni la carte mémoire)
Température de fonctionnement	0 - 40°C
Humidité	5 - 85 %

FR-11

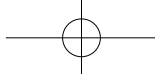

Please refer to the warranty that came with your product or visit our website <http://www.samsungimaging.com/> for after-sales service or inquiries.

Pour toute question ou demande de service après-vente, veuillez consulter les conditions de garantie qui accompagnent le produit ou visitez notre site Internet <http://www.samsungimaging.com/>.



AD68-04795A (1.0)



## Free Manuals Download Website

<http://myh66.com>

<http://usermanuals.us>

<http://www.somanuals.com>

<http://www.4manuals.cc>

<http://www.manual-lib.com>

<http://www.404manual.com>

<http://www.luxmanual.com>

<http://aubethermostatmanual.com>

Golf course search by state

<http://golfingnear.com>

Email search by domain

<http://emailbydomain.com>

Auto manuals search

<http://auto.somanuals.com>

TV manuals search

<http://tv.somanuals.com>