



SAMSUNG

220X POWER ZOOM CAMERA

SCC-C4201(P), C4203(P),  
C4301(P), C4303(P)

Owner's Instructions **E**

Gebrauchsanleitung **D**

Guide d'utilisation **F**

Guía del usuario **Es**

Istruzioni per l'uso **I**

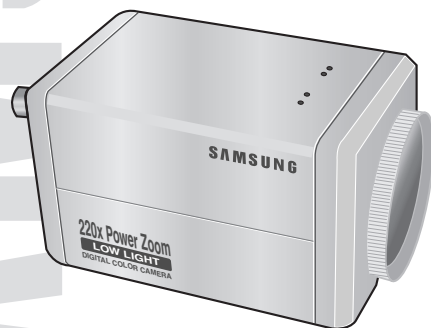

Part : AB68-00366A  
Printed in Korea

\* Be sure to read the "Safety Precautions" in this manual to ensure correct use and operation of this product.



## Safety Precautions

The purpose of safety precautions is to prevent accidental injury or property damage. Always observe all safety precautions.

\* The precautions are divided into "Warnings" and "Cautions" as distinguished below:

<p><b>Warning</b> Ignoring this precaution may result in death or serious injury.</p>	<p><b>Caution</b> Ignoring this precaution may result in injury or damage to property.</p>

### Warnings

- Be sure to use only the standard adapter which is specified in the specification sheet. (page 28~31)  
Using any other adapter could cause fire, electrical shock, or damage to the product.
- Check the external connection terminals first before connecting the power source and signal wires.  
Connect the alarm signal wires to the alarm terminals. Connect the DC12V power adapter to the SCC-C4201(P)/C4203(P) power input, making sure that the correct polarity is observed.  
Connect the DC12V or AC24V power adapter to the SCC-C4301(P)/C4303(P) power input.
- Do not connect multiple cameras to a single adapter. (Exceeding the capacity may cause abnormal heat generation or fire.)
- Securely plug the power cord into the power receptacle. (A loose connection may result in fire.)
- When mounting the camera on a wall or ceiling, fasten it safely and securely. (A falling camera may cause personal injury.)
- Do not place conductive objects (e.g., screwdrivers, coins, and metal things) or containers filled with water on top of the camera. (Serious injury may result from fire, electrical shock, or falling objects.)
- Do not install the unit in humid, dusty, or sooty locations. (Doing so may cause fire or electrical shock.)
- If any unusual smells or smoke come from the unit, stop using the product. In such case, immediately disconnect the power source and contact the service center. (Continued use in such a condition may cause fire or electrical shock.)
- If this product fails to operate normally, contact the store of purchase or your nearest service center. Never disassemble or modify this product in any way. (Problems caused by unauthorized user disassembly or repairs are not covered by your warranty.)
- When cleaning, do not spray water directly onto parts of the product. (Doing so may cause fire or electrical shock.) Gently wipe the surface with a dry cloth. Never use detergents or chemical cleaners on the product, as this may result in discoloration of surface or cause damage to the finish.

E



## Contents



### Cautions

1. Do not drop objects on the product or apply strong shock to it. Keep away from a location subject to excessive vibration or magnetic interference.
2. Do not install in a location subject to high temperature, low temperature, or high humidity. (Doing so may cause fire or electrical shock.)
3. Avoid a location which is exposed to direct sunlight, or near heat sources such as heaters or radiators. (Neglecting to do so may result in a risk of fire.)
4. If you want to relocate the already installed product, be sure to turn off the power before moving or reinstalling it.
5. Install in a well-ventilated location.
6. Remove the power plug from the outlet when there is a lightning storm. (Neglecting to do so may cause fire or damage to the product.)

<b>1. Overview</b> .....	<b>5</b>
<b>2. Part Names and Functions</b> .....	<b>6</b>
<b>3. Installation</b> .....	<b>8</b>
Checking the Package Contents .....	8
Preparing the Cables .....	9
Connecting the Cables .....	10
<b>4. Navigating the Setup Menu</b> .....	<b>12</b>
Structure of the Setup Menu .....	12
- CAMERA ID .....	16
- IRIS .....	17
- BLC .....	17
- ALC .....	17
- MANU .....	18
- SHUTTER .....	19
- AGC (MOTION) .....	20
- WHITE BAL .....	21
- SPECIAL .....	22
- AUTO FOCUS .....	24
- MOTION DET .....	24
- PRESET .....	25
- COLOR/ BW .....	26
- EXIT .....	28
<b>5. Specifications</b> .....	<b>29</b>
<b>6. Others</b> .....	<b>33</b>

## 1 Overview

This camera is a high performance surveillance camera that provides a maximum of 220x zoom surveillance capability with its 22x optical zoom lens and digital zoom IC. It is a multifunction camera that is equipped with all of the key features of the existing surveillance cameras :

- Day & Night function (SCC-C4203(P), C4303(P)) that ensures sharp and clear images even at night.
- Low - Light Surveillance function that enables image capture even under extremely low light conditions.
- White Balance function that provides accurate color rendition under any light conditions.
- BLC function that enables effective back light compensation even under a spotlight or a very bright incident light.
- Auto Focus function that automatically tracks and focuses on the moving subject.
- RS485/ Wired remote control function.

### Broadcast System

- SCC-C4201/ C4203/ C4301/ C4303 : NTSC System
- SCC-C4201P/ C4203P/ C4301P/ C4303P : PAL System

### Power System/Power Consumption

- SCC-C4201(P), C4203(P) : DC 12V/5.0W
- SCC-C4301(P), C4303(P) : AC 24V, DC 12V/5.5W

## 2 Part Names and Functions

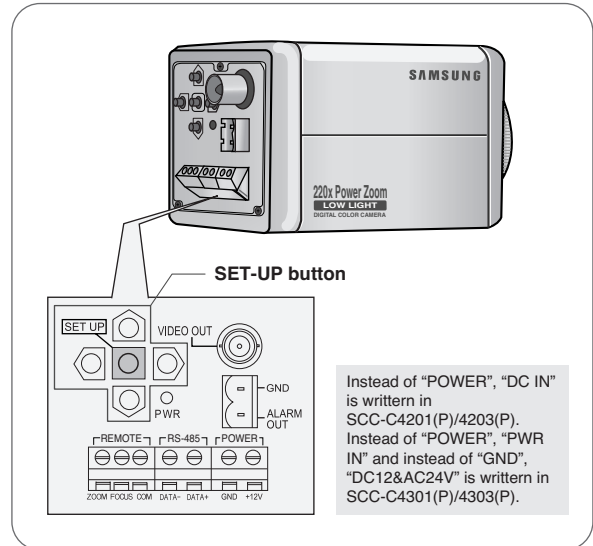

### SET-UP button



The function of the SET-UP button varies depending on whether you are currently in Normal Operation mode (i.e., the Setup Menu is not displayed) or Setup Menu mode.

#### In Normal Operation Mode

- UP/ DOWN buttons : Use as the ZOOM Tele button and the ZOOM Wide button respectively.
- LEFT/ RIGHT buttons : Use as the FOCUS Near button and the FOCUS Far button respectively.
- SET- UP button: Use to enter the Setup Menu. Hold the SET- UP button for longer than 3 seconds to enter the Setup Menu.

## 3 Installation

 In Setup Menu Mode

-  - UP/ DOWN buttons: Use to move the cursor up or down.
-  - LEFT/ RIGHT buttons: Use to move the cursor left or right, or to sequentially view the values that can be assigned to a parameter.
-  - ENTER button: Use to select a Sub Menu item, and to accept the current value.

### ZOOM/ FOCUS REMOTE terminals

Use to control ZOOM/ FOCUS from an external controller. Depending on the input conditions, the terminals can be set to 4 different modes.  
(Operating Voltage Range : +3V ~+13V, -3V~-13V)

Code \ Item	Tele	Wide	Far	Near
A	-6V	+6V	+6V	-6V
B	-6V	+6V	-6V	+6V
C	+6V	-6V	+6V	-6V
D	+6V	-6V	-6V	+6V

**Caution :** In the event of a simultaneous input of RS485 and wired remote control signal, whichever was input first will be activated.  
(For a camera with the ROM version 1.2 or above, please refer to page 33.)

### ALARM OUT terminal

An alarm signal is output from this terminal when the MOTION DET mode is activated or BW mode is activated.  
(Open Collector: DC24V 40mA Max)

### VIDEO OUT terminal

Connect the monitor's VIDEO IN. The video signal from the camera is transmitted to the monitor via this terminal.

### RS485 terminal

RS485 remote control terminal.

### Power LED

Lights when power is on.

### POWER IN terminal

Plug in the power adapter here.

7

## Before Installation

### Checking the Package Contents

Make sure that the following accessories are included in the package.



SCC-C4201(P), C4203(P),  
C4301(P), C4303(P)



User's Guide

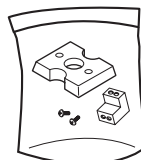

Mount Adapter  
Screw (2)  
Terminal Block

E

8

## Preparing the Cables

To install and use the camera, first prepare the following cables.

The requirements for the power adapter, which connects to the camera's POWER IN terminal, are as follows:

- SCC-C4201(P), SCC-C4203(P) : DC12V 600mA
- SCC-C4301(P), SCC-C4303(P) : AC24V 300mA  
DC12V 600mA

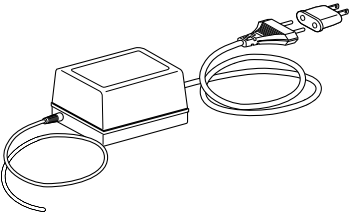

### Video Cable

Use a BNC cable, such as the one shown below, to connect the camera's VIDEO OUT to the monitor.

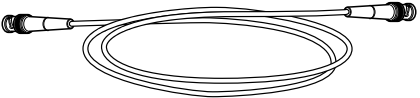

## Connecting the Cables

1. Connect one end of the BNC cable to the VIDEO OUT.
2. Connect the other end of the BNC cable to the VIDEO IN of the monitor.

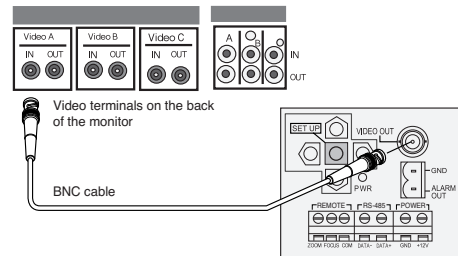

3. Plug in the power adapter. Use a "minus" screwdriver to connect one part of the power adapter, which consists of two lines, to the POWER terminal of the camera as follows :

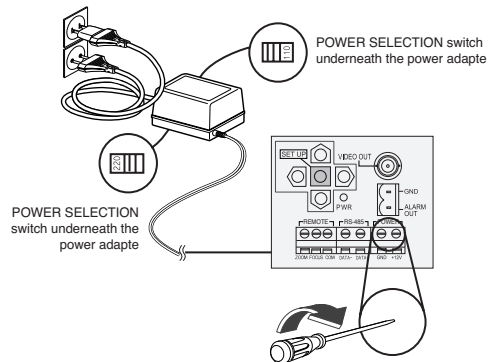



## 4 Navigating the Setup Menu

4. Determine the type of power supply and set the POWER SELECTION switch accordingly. Next, plug the power adapter into a wall outlet.

The requirements for the power adapter for each model are as follows:

- SCC-C4201(P), SCC-C4203(P) : DC12V 600mA
- SCC-C4301(P), SCC-C4303(P) : AC24V 300mA  
DC12V 600mA

5. If the camera operates normally, the following screen will be displayed for 5 seconds and then disappears.

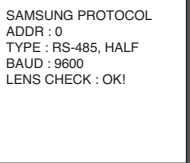

6. The requirements for RS485 control is as follows :
- Signaling Speed: 9600 bps
  - Data Bit : 8 bits
  - Stop Bit : 1 bit
  - Parity Bit : none

In this chapter, we will take a look at the menu system of the SCC-C4201(P), C4203(P), C4301(P), and C4303(P). First, we will take a look at the structure of the Setup Menu and then describe the functions of each menu item in the menu.

### Structure of the Setup Menu

E

#### • Structure of the Setup Menu of the SCC-C4201(P)

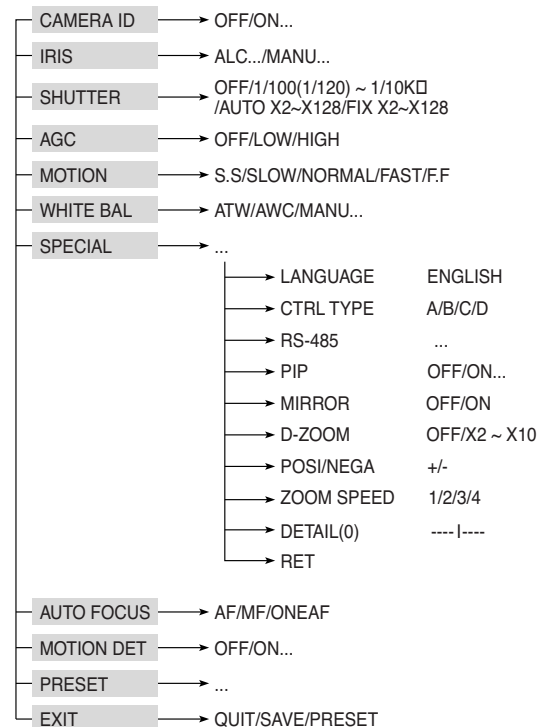

## Structure of the Setup Menu

### • Structure of the Setup Menu of the SCC-C4203(P)

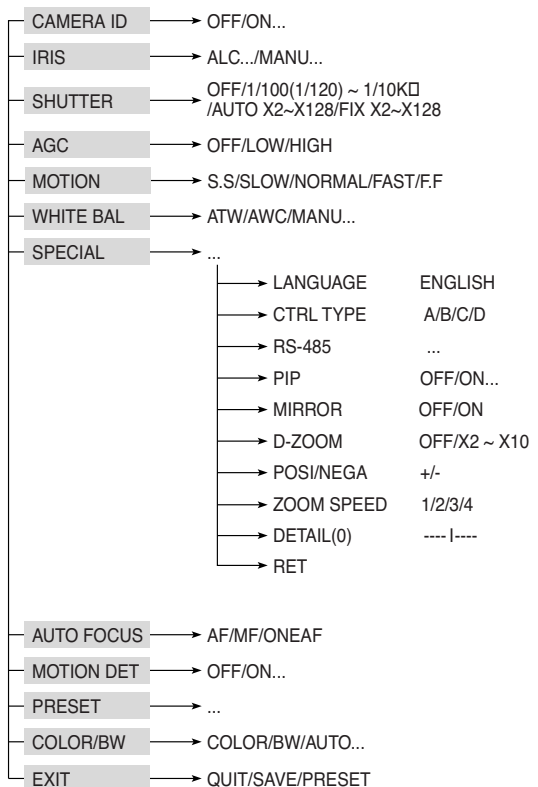

### • Structure of the Setup Menu of the SCC-C4301(P)

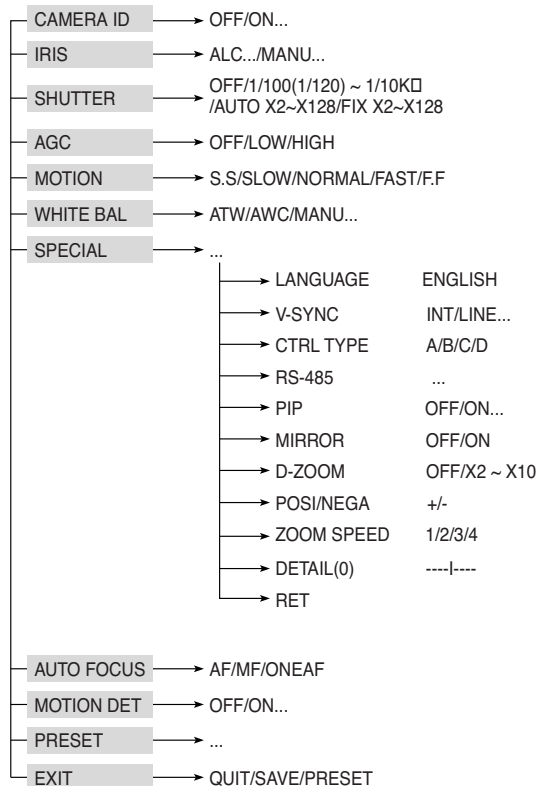

E



## Structure of the Setup Menu

### • Structure of the Setup Menu of the SCC-C4303(P)

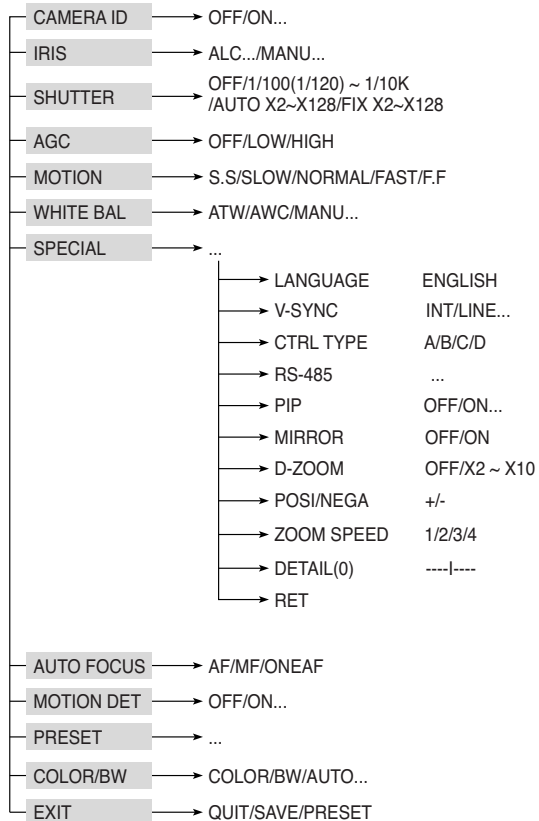

(SET UP)	
CAMERA ID	OFF
IRIS	ALC...
SHUTTER	OFF
AGC	LOW
WHITE BAL	ATW
SPECIAL	...
AUTO FOCUS	ONEAF
MOTION DET	OFF
PRESET	...
EXIT	QUIT

[SCC-C4201(P),SCC-C4301(P)]

(SET UP)	
CAMERA ID	OFF
IRIS	ALC...
SHUTTER	OFF
AGC	LOW
WHITE BAL	ATW
SPECIAL	...
AUTO FOCUS	ONEAF
MOTION DET	OFF
PRESET	...
COLOR/BW	COLOR
EXIT	QUIT

[SCC-C4203(P),SCC-C4303(P)]

E

The COLOR/BW option is available only with the SCC-C4203(P) and C4303(P).

## CAMERA ID

In the CAMERA ID menu, you can assign an ID to the camera that appears on the monitor screen. If you select ON... for CAMERA ID and press the ENTER button, a screen from which you can assign a camera ID will appear. You can use alphanumeric characters and a few special characters that are displayed on the screen to assign a maximum of 20 characters for the CAMERA ID. You can use the LOCATION option to place the camera ID anywhere on the screen.

(SET UP)	
CAMERA ID	ON...
IRIS	ALC...
SHUTTER	OFF
AGC	LOW
WHITE BAL	ATW
SPECIAL	...
AUTO FOCUS	ONEAF
MOTION DET	OFF
PRESET	...
COLOR/BW	COLOR
EXIT	QUIT

Press the  
ENTER  
button.

(CAMERA ID)	
A	B C D E F G H I J K L
M	N O P Q R S T U V W X
Y	Z 0 1 2 3 4 5 6 7 8 9
:	! - + * ( ) /
SP	▶▶ ◀◀ SP
LOCATION...	RET
ZOOM.CAMERA.....	

## IRIS

The level of video output to the monitor can be controlled by the iris lens according to the intensity of the incoming light. This product is equipped with an iris lens. In the ALC (Auto Light Compensation) menu, you can set the video output level. In the MANU menu, you can manually set the opening and closing of the iris.

### BLC (Option in the ALC Menu)

If you use an ordinary camera when a strong light source, such as a spot light, is shining from behind the subject, the subject will appear dark on the monitor because of the back light. For the SCC-C4201(P), C4203(P), C4301(P), and C4303(P), appropriately set the BLC in the ALC menu to solve the back -light problem and have a clear picture even under a spotlight or a very bright incident light.

## ALC

If you select ALC for IRIS and press the ENTER button, a screen from which you can set the video output level and BLC will appear. In the LEVEL option, you can use the LEFT/ RIGHT buttons to set the video output level. If you set the BLC to ON, the BLC function will be applied to the screen area specified in the AREA option. The AREA option can be set to either PRESET or USER to specify the screen area to which the BLC function will be applied. If you set the AREA option to PRESET, the BLC function will be applied to the area specified at the time of factory shipment.

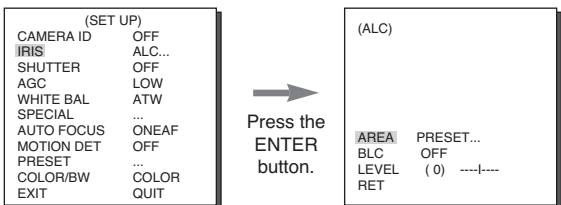

If you set the AREA option to USER and press the ENTER button, you can customize the area to which the BLC function will be applied. You can specify the size of the area by using the UP, DOWN, LEFT, and RIGHT buttons. After setting the size of the area, press the ENTER button. The specified area will start flashing. Then, you can use the UP, DOWN, LEFT and RIGHT buttons to specify the location of the area. Use the ENTER button and the UP, DOWN, LEFT and RIGHT buttons to specify the size of the area and to position the area. Press the ENTER button again to exit the AREA setting menu.

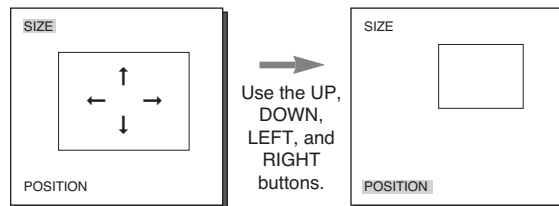

## MANU

If you select MANU for IRIS and press the ENTER button, a screen from which you can manually adjust the iris to a desired level will appear. In the LEVEL option, you can use the LEFT/ RIGHT buttons to set the manual opening and closing of the iris.

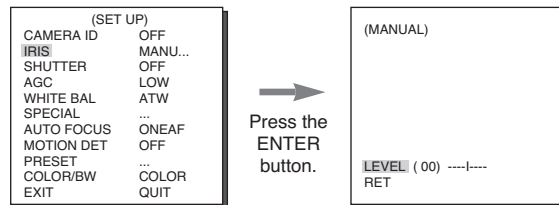

## SHUTTER

In the SHUTTER option, you can specify the speeds of the high-speed electronic shutter, auto low-speed shutter, and fix low-speed shutter. The high - speed electronic shutter supports 7 shutter speeds from 1/100 seconds to 1/10K seconds, and the auto low-speed shutter and fix low-speed shutter support 12 shutter speeds from 2x to 128x respectively. The low-speed shutter allows you to set the shutter speed to a slow setting to obtain a clearer video when shooting in dark lighting conditions. Select an auto low -speed shutter in order to have the camera detect the amount of light and automatically set the shutter speed to a slow setting according to the degree of darkness. Select an item that starts with "FIX" to specify the shutter speed yourself. The numbers that immediately follow the "AUTO" and "FIX" indicate the number of accumulated fields. The higher the field number, the slower the shutter speed. Accordingly, a still picture will be sharper. In the case of video, an image captured of an object will be blurry.

(SET UP)	
CAMERA ID	OFF
IRIS	ALC...
<b>SHUTTER</b>	OFF
AGC	LOW
WHITE BAL	ATW
SPECIAL	...
AUTO FOCUS	ONEAF
MOTION DET	OFF
PRESET	...
COLOR/BW	COLOR
EXIT	QUIT

## SHUTTER

→ OFF → 1/100(1/120) → 1/250 → 1/500 → 1/1000 → 1/2000 → 1/4000 → 1/10K → OFF → AUTOX2 → AUTOX4 → AUTOX6 → AUTOX8 → AUTOX12 → AUTOX16 → AUTOX24 → AUTOX32 → AUTOX48 → AUTOX64 → AUTOX96 → AUTOX128 → OFF → FIXX2 → FIXX4 → FIXX6 → FIXX8 → FIXX12 → FIXX16 → FIXX24 → FIXX32 → FIXX48 → FIXX64 → FIXX96 → FIXX128

## AGC (MOTION)

In the AGC (Automatic Gain Control) option, you can specify whether to automatically control the GAIN when the obtained video is below a certain level of brightness because it was recorded under insufficient lighting. To automatically control the GAIN, set the AGC option to LOW or HIGH. Otherwise, set it to OFF. If the you set the AGC option to LOW, the maximum GAIN of the AGC will be set to low, and if set to HIGH, the maximum GAIN will be set to high. If the SHUTTER option is set to an auto low-speed, the AGC option will change to the MOTION option. In the MOTION option, use the LEFT and RIGHT buttons to select from S.S, SLOW, NORMAL, FAST, and F.F.

(SET UP)	
CAMERA ID	OFF
IRIS	ALC...
SHUTTER	AUTOX4
<b>MOTION</b>	NORMAL
WHITE BAL	ATW
SPECIAL	...
AUTO FOCUS	ONEAF
MOTION DET	OFF
PRESET	...
COLOR/BW	COLOR
EXIT	QUIT

- ☞ **S.S** : Select to maximally enhance the resolution of a still image by increasing the lowest value of AGC GAIN and the scale of low speed shutter to their maximum. (This is used mainly to monitor almost still objects in dark places.)
- ☞ **SLOW** : Select to enhance the resolution of a still image as much as possible by increasing a low value of AGC GAIN and the scale of low speed shutter. (This is used mainly to monitor objects that make a small movement in dark places.)
- ☞ **NORMAL** : Select to display the normal picture with a medium value of AGC GAIN and the scale of normal speed shutter. (This is used mainly to monitor moving objects in dark places.)
- ☞ **FAST** : Select to focus on the moving objects by decreasing a high value of AGC GAIN and the scale of normal speed shutter. (This is used mainly to monitor objects showing active movements in dark places.)
- ☞ **F.F** : Select to focus on the moving objects by decreasing the highest value of AGC GAIN and the scale of low speed shutter to their minimum. (This is used mainly to monitor fast moving objects in dark places.)

## WHITE BAL

In the WHITE BAL option, you can set the White Balance function, which enables you to see the white color correctly under illumination of any color temperature. If you set the WHITE BAL option to ATW, the camera will continuously monitor changes in the ambient color temperature and automatically set the White Balance according to the color temperature. If you set the WHITE BAL option to AWC, place a piece of white paper in front of the camera, and press the ENTER button, the Auto White Balance Control will be activated just once to set the color temperature and this value will be maintained.

If you set the WHITE BAL option to MANUAL, you can customize the white balance to take into account the current lighting condition.

- ☞ 3200°K : Select to set the color temperature to 3200°K.
- ☞ 5600°K : Select to set the color temperature to 5600°K.
- ☞ USER : Select to set the color temperature by selecting appropriate values from the RED and BLUE graphs.

**MANU** : If you select the MANU option and press the ENTER button, a screen from which you can manually select the white balance will appear. In the PRESET option, use the LEFT and RIGHT buttons to select 3200°K, 5600°K, or USER.

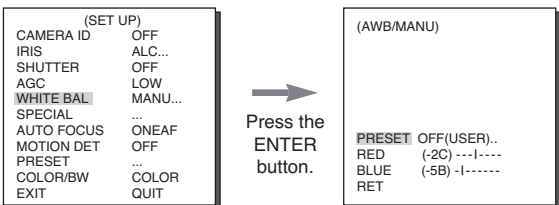

## SPECIAL

You can manually adjust the LANGUAGE, V-SYNC, CTRL TYPE, RS485, PIP, MIRROR, D-ZOOM, POSI/ NEGA, ZOOM SPEED, and DETAIL.

The V-SYNC option is available only with the SCC-C4301(P) and C4303(P).

If you press the ENTER button while "---" is shown, the SPECIAL screen from which you can set the special functions will appear. When activating each function, use the LEFT and RIGHT buttons to set the desired item.

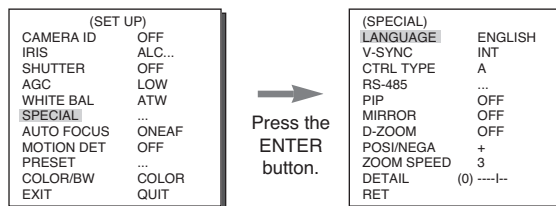

- ☞ **V - SYNC** : Specify the vertical synchronization method that will be used by the SCC-C4301(P) and C4303(P). There are 2 types of vertical synchronization signal that the camera supports : INT mode in which the signal is generated by the camera's internal clock and LINE mode which sets the vertical synchronization by the external power frequency. If you select LINE and press ENTER button, the LL-PHASE screen from which you can adjust the phase of LINE LOCK will appear. You can specify the desired phase level in the PHASE option.

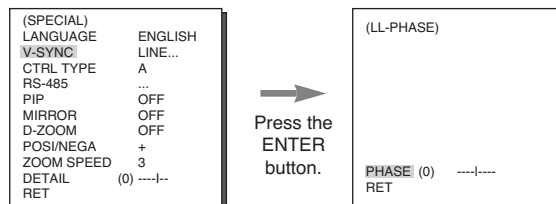

If you are using DC power supply, it will work only in INT mode. For LINE mode operation, use the AC power adapter (50Hz).

**CTRL TYPE** : You can select the A, B, C, or D mode depending on the input of the wired remote control terminal. (See page 7.)

**RS-485** : It sets up ADDRESS, PROTOCOL, and BAUD RATE of RS-485 communication. (BAUD RATE: 2400bps, 4800bps, 9600bps, 19200bps, 38400bps)

**Caution** : A communication error may occur if you connect more than one camera set with an identical address.

**PIP** : This is the Picture in Picture feature. It will show a screen reduced by 1/16 of the main screen only when operating the Digital Zoom. If you set the PIP option to ON and press the ENTER button, you can use the UP, DOWN, LEFT, and RIGHT buttons to set the PIP position.

\* The PIP feature does not work in a low speed shutter mode. The MIRROR feature does not work on the PIP window.

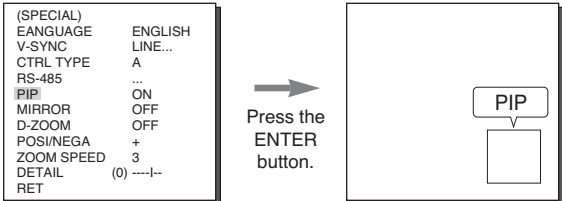

**MIRROR** : Horizontally flips the video output signal.

**D-ZOOM** : Sets the magnification of the Digital Zoom. The magnification level can be set to up to 10x.

**POS/ NEGA** : Outputs the video output signal normally or inversely.

**ZOOM SPEED** : In the ZOOM SPEED option, use the LEFT and RIGHT buttons to set the speed as follows:

- 1 : Takes about 17 seconds from 1 x to 22 x magnification (slowest speed).
- 2 : Takes about 10 seconds from 1 x to 22 x magnification (slow speed).
- 3 : Takes about 6 seconds from 1 x to 22 x magnification (fast speed).
- 4 : Takes about 3 seconds from 1 x to 22 x magnification (fastest speed).

**DETAIL**: Adjusts the sharpness.

## AUTO FOCUS

In the AUTO FOCUS option, you can specify the Focus method to AF, MF, or ONEAF.

**AF** : Focuses automatically by continuously monitoring the screen in AUTO FOCUS mode. It does not process the FOCUS button input because it focuses automatically during ZOOM.

**MF** : You can manually adjust the focus.

**ONEAF** : Focuses about 5 seconds only when ZOOM is moved Wide to Tele. It is same as MF mode while in STOP mode, and same as AF mode after ZOOM Tele.

(SET UP)	
CAMERA ID	OFF
IRIS	ALC...
SHUTTER	OFF
AGC	LOW
WHITE BAL	ATW
SPECIAL	...
AUTO FOCUS	AF
MOTION DET	OFF
PRESET	...
COLOR/BW	COLOR
EXIT	QUIT

E

## MOTION DET

In the MOTION DET option, you can set the Motion Detection function, motion detection sensitivity, and the motion detection area. If you set the Motion Detection function, you can detect an intruder's movement and check it through the monitor and the ALARM OUT terminal.

If you set ALARM which is located under COLOR/BW AUTO menu to ON while MOTION DET remains ON, the ALARM output port can not send any motion.

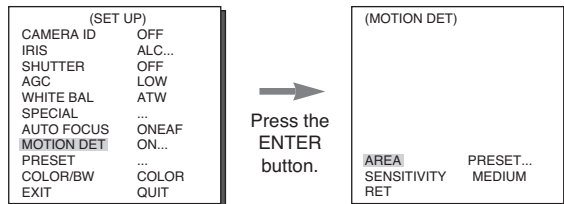

If you select ON and press the ENTER button, the MOTION DET screen will come up. You can set the AREA to which the Motion Detection function will be applied to either PRESET or USER. If you set the AREA option to PRESET, the Motion Detection function will be applied to the areas preset as factory defaults. If you set the AREA option to USER and press the ENTER button, you can change the area size and position and select the area where you want to apply the Motion Detection function. You can specify the size of the area by using the UP, DOWN, LEFT, and RIGHT buttons. If the area is not flashing, press the ENTER button. When the area starts flashing, use the UP, DOWN, LEFT and RIGHT buttons to specify the location of the area. Use the ENTER button and the UP, DOWN, LEFT, and RIGHT buttons to specify the size of the area and to position the area. Press the ENTER button again to exit the AREA setting menu. You can use the SENSITIVITY option to set the motion detection sensitivity. The higher the setting, the more sensitive the motion detection.

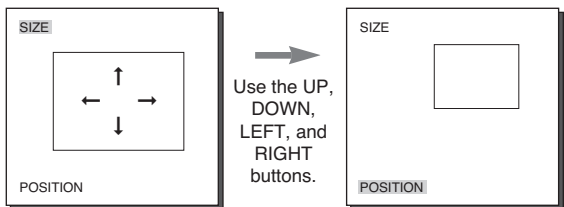

## PRESET

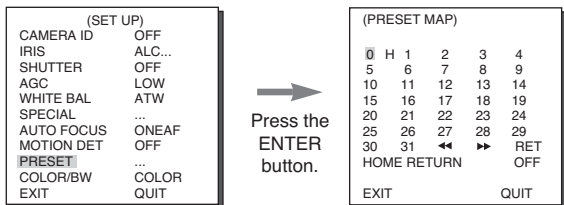

You can store up to 128 ZOOM and FOCUS positions with the PRESET. You can use the PRESET function when you connect the SSC-1000 to the RS-485.

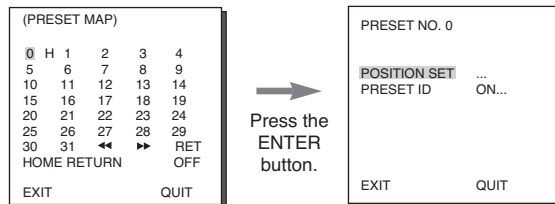

If you select a preset number and press the ENTER button, a screen that looks as above will appear.

- **POSITION SET** : Select to store the ZOOM and FOCUS positions.
- **PRESET ID** : Select to set an ID for the PRESET position, as you did with Camera ID.

The HOME RETURN function is available with a camera with the ROM version 1.2 or above. For instruction on the use of this function, please refer to page 33.

## COLOR / BW

The COLOR / BW option is available only with the SCC-C4203(P) and C4303(P).

In the COLOR / BW option, you can set the IR (infrared) Filter to ON or OFF. In the BW mode, the IR Filter is turned OFF and the level of sensitivity is increased to a level comparable to a black and white camera. In the COLOR mode, on the other hand, the IR Filter is turned ON and the screen turns normal, as the level of sensitivity is decreased.

- **COLOR** : The IR Filter is ON and the screen is normal.
- **BW** : The IR Filter is OFF and the screen is black and white. (Sensitivity to low light is increased to a level comparable to a black and white camera.)
- **AUTO** : Select to automatically switch between the COLOR mode and BW mode depending on the amount of light.

In low light conditions, the IR Filter is turned OFF and the sensitivity to low light is increased by switching to the BW mode, but in bright light conditions, the IR Filter is turned ON and the sensitivity is decreased by switching to the COLOR mode. If you select AUTO and press the ENTER button, a screen from which you can set the ALARM ON/OFF, BURST ON / OFF, BW LEVEL and DWELL TIME will appear.

- ALARM ON : It sends out signals through the ALARM output port in the BW mode.
- ALARM OFF : The ALARM output port is synchronized with the MOTION DET function regardless of the COLOR/BW mode.
- BURST ON : The color burst signal is output together with black and white composite video signal.  
BURST OFF : The color burst signal is not output.
- LEVEL : You can set the brightness level that changes from COLOR mode to BW mode in 3 steps : LOW, MEDIUM, and HIGH.
- DWELL TIME : Set the HOLDING time for switching between COLOR and BW mode depending the changes in the amount of light. You can set the HOLDING time to 10sec (S), 30sec, 60sec, or 300sec (L).

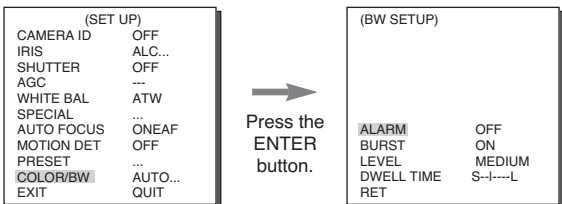

In AUTO mode, AGC will operate in high speed mode, and you cannot change it manually, as it is indicated by "---".



**Caution** : If you use an infrared light source while in AUTO mode, AUTO switching malfunction and camera AF malfunction may occur.

## EXIT

The EXIT option is used to quit the Setup Menu mode and return to the Normal Operation mode.

-  **QUIT** : Select to ignore any changes you have made and restore the previously saved settings.
-  **SAVE** : Select to save the settings that have been changed so far.
-  **PRESET** : Select to ignore any changes you have made and restore the factory default settings.

E



## 5 Specifications

### SCC-C4201/C4203

Item	Description	Remark
Product Type	- 22x Zoom Camera	
Power Supply Voltage	- DC 12V ± 10%	
Power Consumption	- 5.0 W	
Broadcast System	- NTSC Standard Color System	
Imaging Device	- 1/4 inch IT CCD	
Effective Pixe	- 768(H) x 494 (V)	
Scanning Method	- 525 Line, 2:1 Interlace	
Line Frequency	- Horizontal : 15,734 Hz (INT) - Vertical : 59.94 Hz (INT)	
Synchronization Method	- INT Only	
Resolution	- 480 TV Lines	
S/N Ratio	- 52dB(AGC OFF)	
Minimum Scene Illumination	- 0.3Lux(SENS UP X4) (0.01Lux) - B/W(SCC-C4203):0.4Lux (0.003Lux)	
White Balance	- ATW/ AWC/ Manual Mode (3200°K, 5600°K, R/B Gain Control)	
Signal Output	- Composite Video Out : 1.0 Vp-p 75ohms/BNC	
Lens	- 22x Zoom Lens in a single unit - Focal length : 3.6 to 79.2 mm - Aperture : F1.6(Wide), F3.8(Tele) - IR Filter On/Off (SCC-C4203 Only)	
Electronic Shutter	- Off, 1/100, 1/250, 1/500, 1/1K, 1/2K, 1/4K, /10K sec	
Back Light Compensation	- Off / On (Area Setting)	
Sense Up	- Off/Auto 2x~128x/Fix 2x~128x	
Digital Zoom	- Off / On (x10), PIP	
Motion Detection	- Off / On (Area / Sensitivity Setting)	
Operating Temperature and Humidity	- 14°F ~ +122°F, ~90 %	
Dimensions	- 59.5 x 60.5 x 109.5mm	
Weight	- 375g	

### SCC-C4201P/C4203P

Item	Description	Remark
Product Type	- 22x Zoom Camera	
Power Supply Voltage	- DC 12V ± 10%	
Power Consumption	- 5.0 W	
Broadcast System	- PAL Standard Color System	
Imaging Device	- 1/4 inch IT CCD	
Effective Pixe	- 752 (H) X 582 (V)	
Scanning Method	- 625 Line, 2:1 Interlace	
Line Frequency	- Horizontal : 15,625 Hz(INT) - Vertical : 50 Hz(INT)	
Synchronization Method	- INT Only	
Resolution	- 480 TV Lines	
S/N Ratio	- 52dB(AGC OFF)	
Minimum Scene Illumination	- 0.3Lux(SENS UP X4) (0.01Lux) - B/W(SCC-C4203P):0.4Lux (0.003Lux)	
White Balance	- ATW/ AWC/ Manual Mode (3200°K, 5600°K, R/B Gain Control)	
Signal Output	- Composite Video Out : 1.0 Vp-p 75ohms/BNC	
Lens	- 22x Zoom Lens in a single unit - Focal length : 3.6 to 79.2 mm - Aperture : F1.6(Wide), F3.8(Tele) - IR Filter On/Off (SCC-C4203P Only)	
Electronic Shutter	- Off, 1/120, 1/250, 1/500, 1/1K, 1/2K, 1/4K, /10K sec	
Back Light Compensation	- Off / On (Area Setting)	
Sense Up	- Off/Auto 2x~128x/Fix 2x~128x	
Digital Zoom	- Off / On (x10), PIP	
Motion Detection	- Off / On (Area / Sensitivity Setting)	
Operating Temperature and Humidity	- 14°F ~122°F, ~90 %	
Dimensions	- 59.5 x 60.5 x 109.5mm	
Weight	- 375g	

E





## Specifications

### SCC-C4301/C4303

Item	Description	Remark
Product Type	- 22x Zoom Camera	
Power Supply Voltage	- AC 24V (60Hz) or DC 12V ± 10%	
Power Consumption	- 5.5W	
Broadcast System	- NTSC Standard Color System	
Imaging Device	- 1/4 inch IT CCD	
Effective Pixe	- 768(H) X 494(V)	
Scanning Method	- 525 Line, 2:1 Interlace	
Line Frequency	- Horizontal : 15,734 Hz(INT), 15,750 Hz(L/L) - Vertical : 59.94 Hz(INT), 60 Hz(L/L)	
Synchronization Method	- INT / Line Lock	
Resolution	- 480 TV Lines	
S/N Ratio	- 52dB(AGC OFF)	
Minimum Scene Illumination	- 0.3Lux(SENS UP X4) (0.01Lux) - B/W(SCC-C4303):0.4Lux (0.003Lux)	
White Balance	- ATW/ AWC/ Manual Mode (3200°K, 5600°K, R/B Gain Control)	
Signal Output	- Composite Video Out : 1.0 Vp-p 75ohms/BNC	
Lens	- 22x Zoom Lens in a single unit - Focal length : 3.6 to 79.2 mm - Aperture : F1.6(Wide), F3.8(Tele) - IR Filter On / Off (SCC-C4303 Only)	
Electronic Shutter	- Off, 1/100, 1/250, 1/500, 1/1K, 1/2K, 1/4K, /10K sec	
Back Light Compensation	- Off / On (Area Setting)	
Sense Up	- Off/Auto 2x~128x/Fix 2x~128x	
Digital Zoom	- Off / On (x10), PIP	
Motion Detection	- Off / On (Area / Sensitivity Setting)	
Operating Temperature and Humidity	- 14°F ~122°F, ~90 %	
Dimensions	- 59.5 x 60.5 x 143mm	
Weight	- 500g	

### SCC-C4301P/C4303P

Item	Description	Remark
Product Type	- 22x Zoom Camera	
Power Supply Voltage	- AC 24V (50Hz) or DC 12V ± 10%	
Power Consumption	- 5.5W	
Broadcast System	- PAL Standard Color System	
Imaging Device	- 1/4 inch IT CCD	
Effective Pixe	- 752(H) X 582(V)	
Scanning Method	- 625 Line, 2:1 Interlace	
Line Frequency	- Horizontal : 15,625 Hz(INT), 15,625 Hz(L/L) - Vertical : 50 Hz(INT), 50 Hz(L/L)	
Synchronization Method	- INT / Line Lock	
Resolution	- 480 TV Lines	
S/N Ratio	- 52dB(AGC OFF)	
Minimum Scene Illumination	- 0.3Lux(SENS UP X4) (0.01Lux) - B/W(SCC-C4303P):0.4Lux (0.003Lux)	
White Balance	- ATW/ AWC/ Manual Mode (3200°K, 5600°K, R/B Gain Control)	
Signal Output	- Composite Video Out : 1.0 Vp-p 75ohms/BNC	
Lens	- 22x Zoom Lens in a single unit - Focal length : 3.6 to 79.2 mm - Aperture : F1.6(Wide), F3.8(Tele) - IR Filter On/ Off (SCC-C4303P Only)	
Electronic Shutter	- Off, 1/120, 1/250, 1/500, 1/1K, 1/2K, 1/4K, /10K sec	
Back Light Compensation	- Off / On (Area Setting)	
Sense Up	- Off/Auto 2x~128x/Fix 2x~128x	
Digital Zoom	- Off / On (x10), PIP	
Motion Detection	- Off / On (Area / Sensitivity Setting)	
Operating Temperature and Humidity	- 14°F ~122°F, ~90 %	
Dimensions	- 59.5 x 60.5 x 143mm	
Weight	- 500g	

E



## 6 Others



### ZOOM/FOCUS Remote Terminals

These terminals are to activate the ZOOM/FOCUS, MENU CONTROL, HOME RETURN, and AF functions by using an external controller. They could be set to one of four modes depending on the input condition: A, B, C, and D. (SPECIAL - CTRL TYPE)

(Operating Voltage Range : +3V~+13V, -3V~-13V)

- 1) If voltage is applied to either the ZOOM or FOCUS terminal, but not both

Function <sup>1</sup> Code	TELE (Up)	WIDE (Down)	NEAR (Left)	FAR (Right)
	ZOOM Terminal		FOCUS Terminal	
A	-6V	+6V	-6V	+6V
B	-6V	+6V	+6V	-6V
C	+6V	-6V	-6V	+6V
D	+6V	-6V	+6V	-6V

- 1: In MENU OFF, these are used to control the ZOOM/FOCUS function, and in MENU ON, these are used as the UP, DOWN, LEFT, and RIGHT keys

- 2) If voltage is applied to the ZOOM and FOCUS terminals at the same time

Function Code	ENTER/AF <sup>1</sup>		HOME RETURN <sup>2</sup>	
	ZOOM Terminal	FOCUS Terminal	ZOOM Terminal	FOCUS Terminal
A	-6V	-6V	+6V	+6V
B	-6V	+6V	+6V	-6V
C	+6V	-6V	-6V	+6V
D	+6V	+6V	-6V	-6V

- 1 : With the menu "off", if voltage is applied for shorter than 2 seconds, the AF function will be activated, and if voltage is applied for longer than 2 seconds, the menu will be "on". With the menu "on", if voltage is applied, the ENTER function will be activated.
- 2 : If voltage is applied for longer than 2 seconds, the camera will return to the specified home position (PRESET 0).

E

### HOME RETURN

If no keys are pressed for a period of time, the camera will automatically return to the specified home position. The home position is set to PRESET 0. If the position of PRESET 0 has not been saved, the HOME RETURN function will not work.

#### Setting the Home Return Time

→ OFF → 1 MIN → 2 MIN → 3 MIN~60 MIN → 2HOUR →  
3HOUR ~12HOUR



# Memo

.....

.....

.....

.....

.....

.....

.....

.....

.....

.....

.....

.....

.....

.....

.....

.....

.....

.....

.....

.....

.....

.....



# Memo

.....

.....

.....

.....

.....

.....

.....

.....

.....

.....

.....

.....

.....

.....

.....

.....

.....

.....

.....

.....

## Free Manuals Download Website

<http://myh66.com>

<http://usermanuals.us>

<http://www.somanuals.com>

<http://www.4manuals.cc>

<http://www.manual-lib.com>

<http://www.404manual.com>

<http://www.luxmanual.com>

<http://aubethermostatmanual.com>

Golf course search by state

<http://golfingnear.com>

Email search by domain

<http://emailbydomain.com>

Auto manuals search

<http://auto.somanuals.com>

TV manuals search

<http://tv.somanuals.com>