



Contact SAMSUNG WORLDWIDE

If you have any questions or comments about your Samsung TV, please contact the SAMSUNG customer care center.

Comment contacter Samsung dans le monde

Si vous avez des suggestions ou des questions concernant les produits Samsung, veuillez contacter le Service Consommateurs Samsung.

Comuníquese con SAMSUNG WORLD WIDE

Si desea formular alguna pregunta o comentario en relación con los productos de Samsung, comuníquese con el centro de atención al cliente de SAMSUNG.

Country	CANADA	U.S.A
Address	Samsung Electronics Canada Inc., Customer Service 55 Standish Court Mississauga Ontario L5R 4B2 Canada	Samsung Electronics America, Inc. 85 Challenger Road Ridgefield Park, NJ 07660
Customer Care Center ☎	1-800-SAMSUNG (726-7864)	
Web Site	www.samsung.com/ca (English) www.samsung.com/ca_fr (French)	www.samsung.com



SERIES **4+** **5+**
4500
4550
5300
5350

Plasma TV

user manual

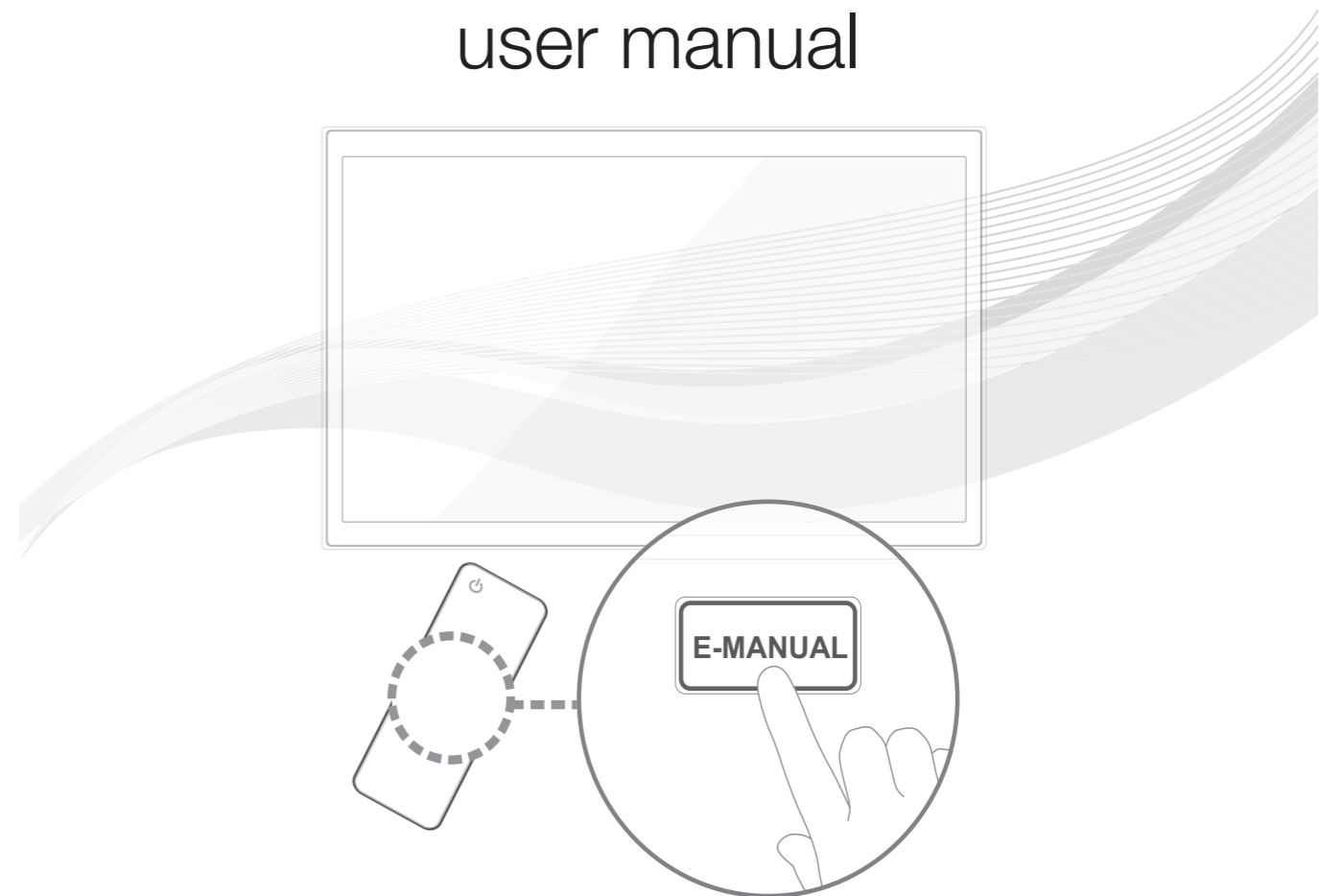

Thank you for purchasing this Samsung product.
 To receive more complete service, please register
 your product at

www.samsung.com/register

Model _____ Serial No. _____

☎ If you have any questions, please call us at 1-800-SAMSUNG (1-800-726-7864) for assistance.



BN68-04798D-02

Important Safety Instructions

SAMSUNG

Warning! Important Safety Instructions

Please read the safety instructions below before installing and using the product.

CAUTION

RISK OF ELECTRIC SHOCK. DO NOT OPEN.

CAUTION: TO REDUCE THE RISK OF ELECTRIC SHOCK, DO NOT REMOVE COVER (OR BACK). THERE ARE NO USER SERVICEABLE PARTS INSIDE. REFER ALL SERVICING TO QUALIFIED PERSONNEL.



This symbol indicates that high voltage is present inside. It is dangerous to make any kind of contact with any internal part of this product.



This symbol indicates that important literature concerning operation and maintenance has been included with this product.

- The slots and openings in the cabinet and in the back or bottom are provided for necessary ventilation. To ensure reliable operation of this apparatus, and to protect it from overheating, these slots and openings must never be blocked or covered.
 - Do not cover the slots and openings with a cloth or other materials.
 - Do not block the slots and openings by placing this apparatus on a bed, sofa, rug or other similar surface.
 - Do not place this apparatus in a confined space, such as a bookcase or built-in cabinet, unless proper ventilation is provided.
- Do not place this apparatus near or over a radiator or heat register, or where it is exposed to direct sunlight.
- Do not place a vessel containing water (vases etc.) on this apparatus, as this can result in a risk of fire or electric shock.
- Do not expose this apparatus to rain or place it near water (near a bathtub, washbowl, kitchen sink, or laundry tub, in a wet basement, or near a swimming pool etc.). If this apparatus accidentally gets wet, unplug it and contact an authorized dealer immediately.
- Make sure to pull out the power cord from the outlet before cleaning.
- This apparatus use batteries. In your community, there might be regulations that require you to dispose of these batteries properly to protect the environment. Please contact your local authorities for disposal or recycling information.
- Do not overload wall outlets, extension cords, or adaptors beyond their capacity, since this can result in fire or electric shock.
- Power-supply cords should be routed so that they are not likely to be walked on or pinched by items placed upon or against them. Pay particular attention to cords at the plug end, where connected to adaptors, and at the point where they exit from the apparatus.
- To protect this apparatus from a lightning storm, or when it is left unattended and unused for long periods of time, unplug it from the wall outlet and disconnect the antenna or cable system. This will prevent damage to the set due to lightning and power line surges.
- Before connecting the AC power cord to the DC adaptor outlet, make sure the voltage designation of the DC adaptor corresponds to the local electrical supply. (depending on the model)
- Never insert anything metallic into the open parts of this apparatus. Doing so may create a danger of electric shock.
- To avoid electric shock, never touch the inside of this apparatus. Only a qualified technician should open this apparatus.
- Make sure to plug the power cord in until it is firmly inserted. Pull on the plug, not the cord, when removing the power cord from the outlet. Do not touch the power cord with wet hands.
- If this apparatus does not operate normally - in particular, if there are any unusual sounds or smells coming from it - unplug it immediately and contact an authorized dealer or service center.
- Be sure to pull the power plug out of the outlet if the TV is to remain unused or if you are to leave the house for an extended period of time (especially when children, elderly or disabled people will be left alone in the house).
 - Accumulated dust can cause an electric shock, an electric leakage, or a fire by causing the power cord to generate sparks and heat, or cause the insulation to deteriorate.
- Be sure to contact an authorized service center, when installing your set in a location with heavy dust, high or low temperatures, high humidity, chemical substances or where it will operate for 24 hours a day such as in an airport, a train station, etc. Failure to do so may cause serious damage to your set.
- Use only a properly grounded plug and receptacle.
 - An improper ground may cause electric shock or equipment damage. (Class I Equipment only.)
- To turn off the apparatus completely, you must pull the power plug out of the wall socket. Consequently, the power plug should be readily accessible at all times.
- Do not allow children to hang onto the product.
- Store the accessories (batteries, etc.) in a location safely out of the reach of children.
- Do not install the product in an unstable location such as a shaky self, a slanted floor, or a location exposed to vibration.
- Do not drop or impart a shock to the product. If the product is damaged, disconnect the power cord and contact a service center.
- To clean the product, unplug the power cord from the power outlet and wipe the product using a soft cloth dipped in a small amount of water. Do not use any chemicals such as wax, benzene, alcohol, thinners, insecticide, air freshener, lubricant or detergent. This may damage the appearance or erase the printing on the product.
- Do not expose the apparatus to dripping or splashing.
- Do not dispose of batteries in a fire.
- Do not short circuit, disassemble, or overheat the batteries.
- There is a danger of explosion if you replace the batteries with the wrong type of battery. Replace only with the same or equivalent type.
- **WARNING - TO PREVENT THE SPREAD OF FIRE, KEEP CANDLES OR OTHER OPEN FLAMES AWAY FROM THIS PRODUCT AT ALL TIMES.**



A detailed User's Manual is built into your TV. For more information about how to view this e-Manual, see page 10.

Figures and illustrations in this User Manual are provided for reference only and may differ from actual product appearances. Product design and specifications may be changed without notice.

Important User Information

- **Screen Image retention**

Avoid displaying a still image, such as an image from a video game or a small fixed channel logo, on the plasma display panel for more than a few minutes as it can cause screen image retention. This image retention is also known as "screen burn".

If displaying a still image is unavoidable, decrease the possibility of image retention by reducing the brightness and contrast of the screen.

- **Heat on the top of the Plasma TV**

The top side of the TV may become hot after long periods of use as heat dissipates from the panel through the vent hole in the upper part of the TV. This is normal and does not indicate any defect or operational failure of the unit. However, children should be prevented from touching the upper part of the TV.

- **The TV is making a 'cracking' noise.**

A 'cracking' noise may occur when the TV contracts or expands due to a change in the surrounding environment such as temperature or humidity. This is normal and not a defect.

- **Cell Defects**

Your plasma TV has a panel containing 2,360,000 (HD-level) to 6,221,000 (FHD-level) pixels which require sophisticated technology to produce. However, there may be a few bright or dark pixels on the screen. These pixels will have no impact on the performance of the product.

- **Avoid operating the TV at temperatures below 41°F (5°C)**

- **A still image displayed too long may cause permanent damage to the PDP Panel.**

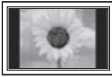

Watching the Plasma TV in 4:3 format for a long period of time may leave traces of the borders on the left, right, top, or bottom of the screen. Playing a DVD or a game console may have a similar effect.

Damage caused by the above effect is not covered by the warranty.

- **After-images on the Screen.**

Displaying still images from Video games and PC's for longer than a certain period of time may produce partial after-images.

To prevent this effect, reduce the 'brightness' and 'contrast' when displaying still images for a long time.

- **Warranty**

Warranty does not cover any damage caused by image retention.

Burn-in is not covered by the warranty.

- **Caution**



The glass screen of your PDP TV can break if you accidentally drop the TV. Handle the TV with care.

When moving the TV, always have two or more people pick it up and carry it as a safety precaution. Do not lay the TV flat on its face or back.

Your Samsung Plasma TV is a high quality television that has been carefully packaged to protect the integrity of its glass panel and component parts during shipment. It is, nonetheless, a fragile piece of electronics that requires careful handling. Refrain from putting undue stress on any part of the packaging when shipping or unpacking the TV. Use care when installing the TV. Avoid placing the TV in a location where it may be struck, exposed to sharp impacts, or fall. Panel breakage caused by a fall or impact strike is not covered under the manufacturer's warranty.

Providing Proper Ventilation for Your TV

When you install your TV, maintain a distance of at least 4 inches between the TV and other objects (walls, cabinet sides, etc.) to ensure proper ventilation. Failing to maintain proper ventilation may result in a fire or a problem with the product caused by an increase in its internal temperature.

Whether you install your TV using a stand or a wall-mount, use parts provided by Samsung Electronics only.

- If you use parts provided by another manufacturer, it may cause difficulties with the product or result in injury caused by the product falling.

Installation with a stand.

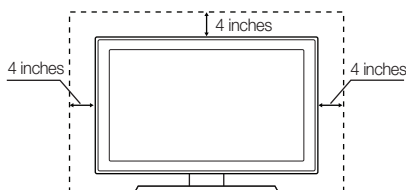

Installation with a wall-mount.

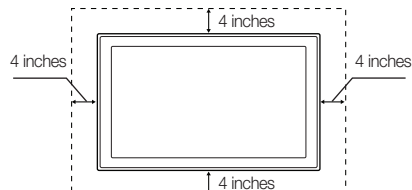

List of Features

- **Media Play:** Media Play lets you access, view, or play photos, videos, or music located on USB devices and digital cameras.
- **e-Manual:** Provides a detailed, on-screen user's manual built into your TV. (page 10)

Accessories and Cables

- ✎ Please make sure the following items are included with your TV. If any items are missing, contact your dealer.
- ✎ The items' colors and shapes may vary depending on the model.
- ✎ Check that there are no accessories hidden behind or under packing materials after you open the box.

- Remote Control (AA59-00785A) & Batteries (AAA x 2)
- Owner's Instructions
- Power Cord
- Cleaning Cloth (BN63-01798B)
- Regulatory Guide

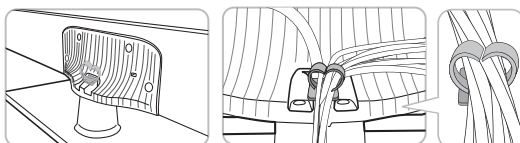

- Stand Wire Holder (BN61-08370A)
- Assembling the Stand Wire Holder

Input Cables (Sold Separately)

To purchase an HDMI cable, contact www.SamsungParts.com.



HDMI



HDMI-DVI



Component



Composite (AV)



Coaxial (RF)

- ✎ Make sure you have the correct cable before plugging it in. Illustrations of common plugs and jacks are below.

	Cable Plugs	Ports/Jacks
HDMI		
USB		
Optical		



Do not plug in opposite or wrong direction. It could damage the TV port.

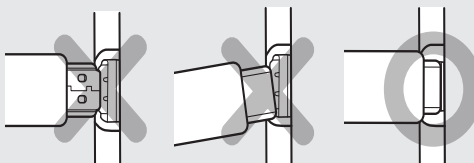

- ✎ For the best cable connection to this product, use cables no thicker than the cable illustrated below:

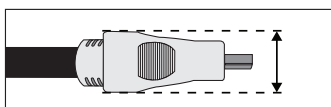

- Maximum thickness - 0.55 inches (14mm)

Making Connections

Connect your TV to an antenna or cable connection, and then connect your peripherals. When done, connect the power cord to the TV, and then connect the power cord to an AC wall outlet. If you are connecting your TV to a cable or satellite box using HDMI, Component, or Composite connections, you do not need to connect the ANT IN jack to an antenna or a cable connection.

- For the best picture and audio quality, connect digital devices using an HDMI cable.
- If you connect an external device to the TV that uses an older version of HDMI, the video and audio may not work. If this occurs, ask the manufacturer of the device about the HDMI version and, if it is out of date, request an upgrade.
- Be sure to purchase a certified HDMI cable. Otherwise, the picture may not display or a connection error may occur.
- PC/DVI AUDIO IN input is not supported.
- For a set-top box connection using an HDMI cable, we highly recommend you connect the cable to the HDMI IN 1(STB) port.
- For an HDMI to DVI cable connection, you must use the HDMI IN 2(DVI) jack.
- If you connect a device to the HDMI IN 2(DVI) port using an HDMI to DVI cable, the audio will not work. DVI does not transmit audio. You must add a separate audio connection.
- For PCs with DVI video out jacks, use an HDMI to DVI cable to connect the DVI out on the PC to the HDMI IN 2(DVI) jack on the TV. Use the PC's speakers for audio.

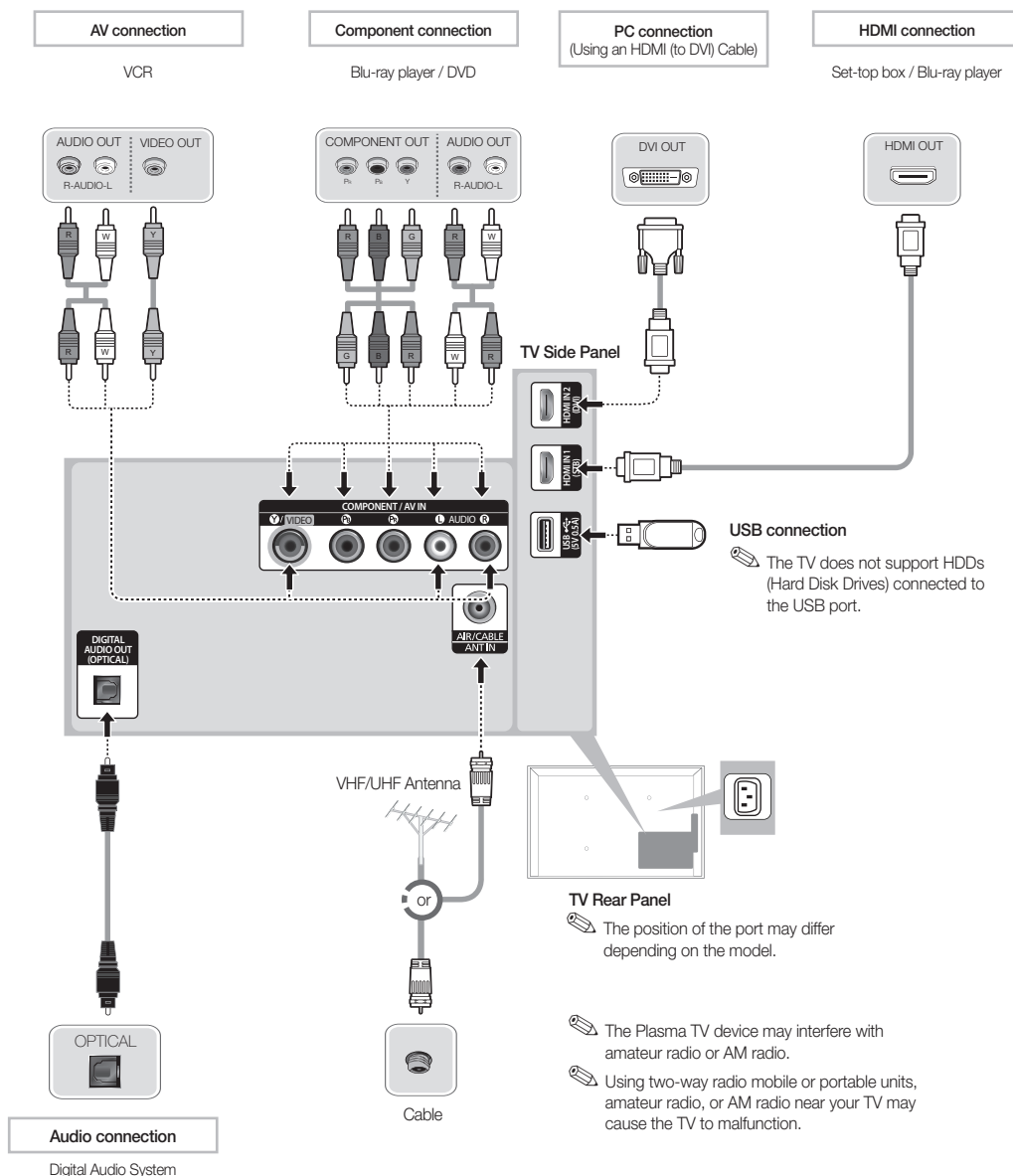

Display Modes for HDMI Input

The optimal resolution for the 4 series TVs is 1024 x 768@60Hz. For the 5 series, 1920 x 1080@60Hz. If you connect the TV to a device such as a PC or Set-Top-Box using an HDMI input, we recommend that you set the video output of that device to the optimal resolution of the TV. If that is not possible, you can set the device to one of the resolutions listed below.

Mode	Resolution	Horizontal Frequency (KHz)	Vertical Frequency (Hz)	Pixel Clock Frequency (MHz)	Sync Polarity (H / V)	1024 X 768	1920 X 1080
IBM	720 x 400	31.469	70.087	28.322	-/+	✓	✓
MAC	640 x 480	35.000	66.667	30.240	-/-	✓	✓
	832 x 624	49.726	74.551	57.284	-/-	✓	✓
	1152 x 870	68.681	75.062	100.000	-/-		✓
VESA DMT	640 x 480	31.469	59.940	25.175	-/-	✓	✓
	640 x 480	37.861	72.809	31.500	-/-	✓	✓
	640 x 480	37.500	75.000	31.500	-/-	✓	✓
	800 x 600	37.879	60.317	40.000	+/+	✓	✓
	800 x 600	48.077	72.188	50.000	+/+	✓	✓
	800 x 600	46.875	75.000	49.500	+/+	✓	✓
	1024 x 768	48.363	60.004	65.000	-/-	✓	✓
	1024 x 768	56.476	70.069	75.000	-/-	✓	✓
	1024 x 768	60.023	75.029	78.750	+/+	✓	✓
	1152 x 864	67.500	75.000	108.000	+/+		✓
	1280 x 720	45.000	60.000	74.250	+/+		✓
	1280 x 800	49.702	59.810	83.500	-/+		✓
	1280 x 1024	63.981	60.020	108.000	+/+		✓
	1280 x 1024	79.976	75.025	135.000	+/+		✓
	1366 x 768	47.712	59.790	85.500	+/+		✓
	1440 x 900	55.935	59.887	106.500	-/+		✓
	1600 x 900RB	60.000	60.000	108.000	+/+		✓
1680 x 1050	65.290	59.954	146.250	-/+		✓	
1920 x 1080	67.500	60.000	148.500	+/+		✓	

 The interlace mode is not supported.

 The set might operate abnormally if a non-standard video format is selected.

The Remote Control Buttons

 This remote control has Braille points on the Power, Channel, and Volume buttons and can be used by visually impaired persons.

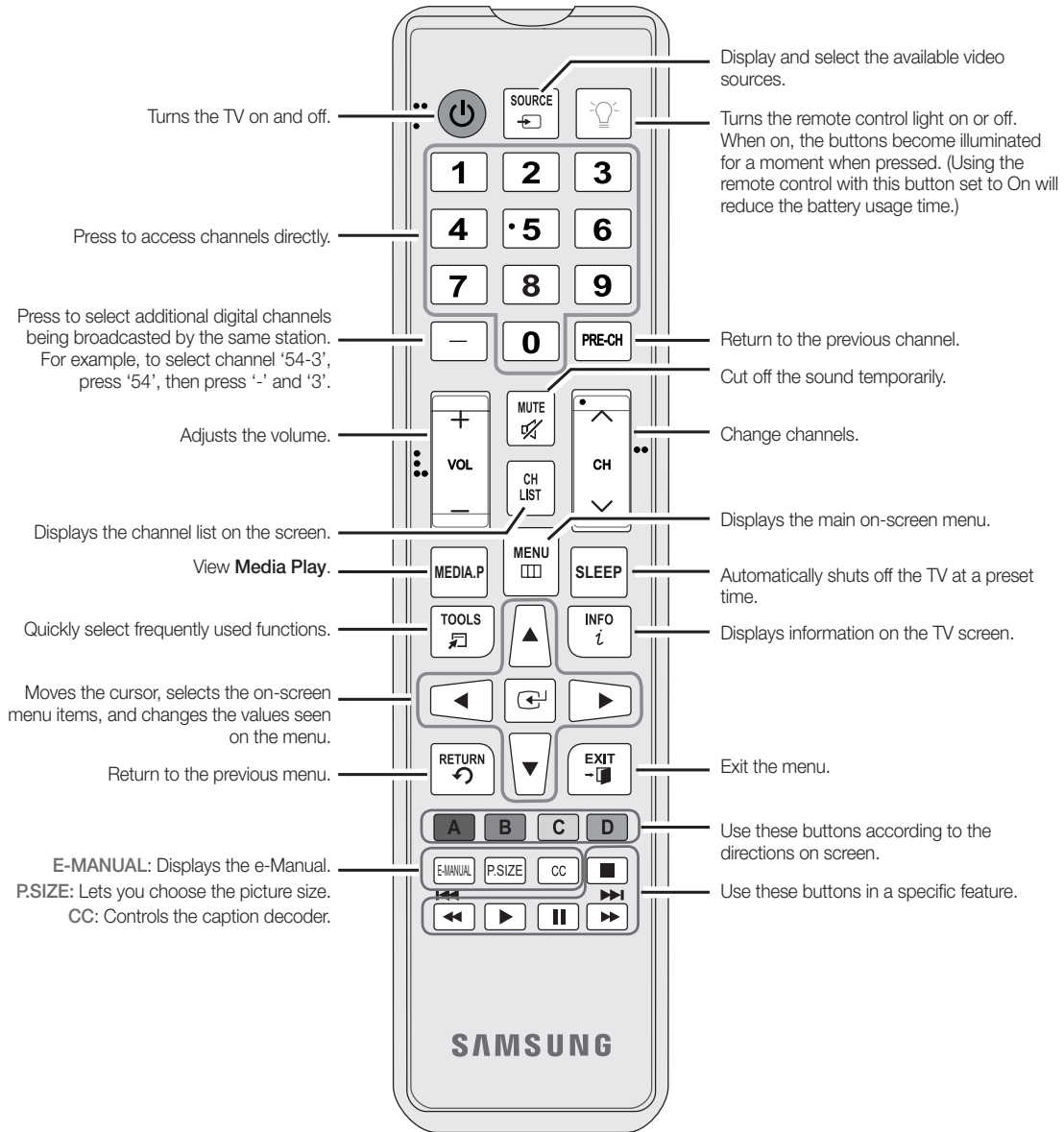

Installing the Batteries Into the Remote

Installing batteries (Battery size: AAA)

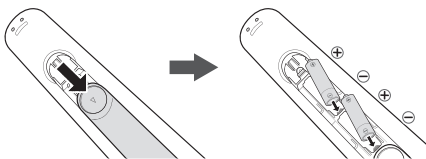

NOTE

- Install the batteries so that the polarity of the batteries (+/-) matches the illustration in the battery compartment.
- Use the remote control within 23 feet of the TV.
- Bright light may affect the performance of the remote control. Avoid using when near fluorescent lights or neon signs.
- The color and shape may vary depending on the model.

Changing the Input Source

Source

When you are watching TV and you want to watch a movie on your DVD player or Blu-ray player or switch to your cable box or STB satellite receiver, you need to change the Source.

1. Press the **SOURCE** button on your remote.
2. Select a desired external input source.

■ TV / HDMI1 / HDMI2/DVI / AV / Component

 You can only choose external devices that are connected to the TV. In the **Source** list, connected inputs are highlighted.





How to Use Edit Name

Edit Name lets you associate a device name to an input source, for example, Blu-ray to HDMI 1. To access **Edit Name**, press the **TOOLS** button when the **Source** list is displayed. The following selections appear under **Edit Name**:

VCR / DVD / Cable STB / Satellite STB / PVR STB / AV Receiver / Game / Camcorder / PC / DVI PC / DVI Devices / TV / IPTV / Blu-ray / HD DVD / DMA

Select the name of the device connected to each input jack to make your input source selection easier. When you view the **Source** list, the device name and the input jack will be displayed together.



-  If you have connected a PC to the **HDMI IN 2(DVI)** port with an HDMI cable, select **PC** under **Edit Name** to enter a device name.
-  If you have connected a PC to the **HDMI IN 2(DVI)** port with an HDMI to DVI cable, select **DVI PC** under **Edit Name** to enter a device name.
-  If you connected an AV device to the **HDMI IN 2(DVI)** port with an HDMI to DVI cable, select **DVI Devices** under **Edit Name** to enter a device name.

Information (in the Edit Name function)

Displays detailed information about the connected external device.

Configuring the Basic Settings in Initial Setup

When you turn the TV on for the first time, a sequence of screens and on-screen prompts will assist you in configuring the TV's basic settings. Plug the power cord into a wall outlet, and then press the **POWER** button to turn on the TV. Configure your TV's basic settings in the initial setup by following the instructions on your TV's screen.

-  **Setup** is available only when the **Source** is set to **TV**.
-  If you are not using a cable box or satellite box, make you sure have connected the TV to an antenna or cable connection before you turn on the TV.

If You Want to Re-run Setup...

 **MENU** → **System** → **Setup** → **ENTER** 

Changing the Use Mode

Select the **Use Mode** suitable for the location in which you will use the TV. We strongly recommend you select **Home Use**.

-  If your TV has been unintentionally set to **Store Demo**, you can change the mode with this option.
- **Home Use:** **Home Use** is the default setting.
- **Store Demo:** **Store Demo** is for retail environments only. If you select **Store Demo**, some functions will not work and the picture settings will be reset every 30 minutes.

How to Navigate Menus

Your TV's Main and Tools menus contains functions that let you control the TV's features. For example, in the Main menu you can change the size and configuration of the picture, its brightness, its contrast and so on. There are also functions that let you control the TV's sound, channel configuration, energy use, and a host of other features. To access the main, on-screen menu, press the **MENU** (III) button on your remote. To access Tools menus, press the **TOOLS** button. Tools menus are available when the **TOOLS** menu icon is displayed on the bottom right of the screen.

The illustration below displays the buttons on the remote you use to navigate the menus and select and adjust different functions.

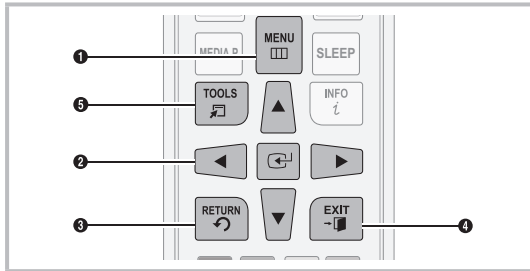

- 1 **MENU** button: Displays the main on-screen menu.
- 2 **ENTER** and Direction buttons: Use the Direction buttons to move the cursor and highlight an item. Use the Enter button to select an item or confirm the setting.
- 3 **RETURN** button: Returns to the previous menu.
- 4 **EXIT** button: Exits the on-screen menu.
- 5 **TOOLS** button: Displays the Tools menus when available.

How to Operate the Main Menu (OSD - On Screen Display)

The access steps may differ depending on the menu option you select.

1	MENU	The main menu options appear on the screen: Picture, Sound, Broadcasting, Applications, System, Support.
2	▲ / ▼	Select a main menu option on the left side of the screen with the ▲ or ▼ button.
3	ENTER	Press ENTER to access the sub-menu.
4	▲ / ▼	Select the desired submenu with the ▲ or ▼ button.
5	◀ / ▶	Adjust the value of an item with the ◀ or ▶ button. The adjustment in the OSD may differ depending on the selected menu.
6	ENTER	Press ENTER to confirm the selection.
7	EXIT	Press EXIT .

Using the TV's Controller (Panel Key)

The TV's Controller, a small joy stick like button on the rear left side of the TV, lets you control the TV without the remote control. To open a function and view it on the screen or select a setting displayed on the screen, push the controller backwards, forwards, left, or right. To confirm a setting after you have selected it, press up on the Controller.

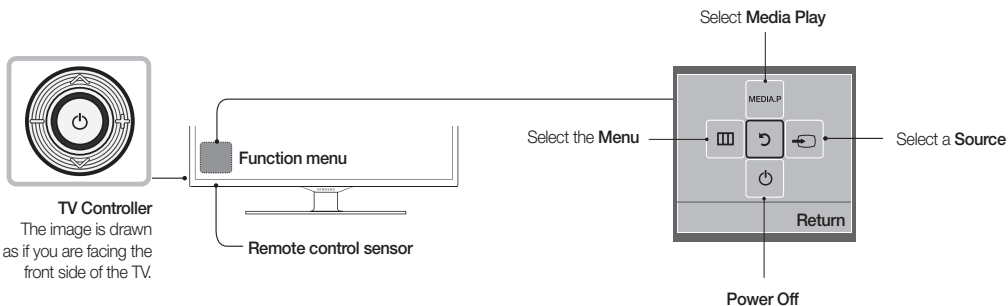

- To close the **Menu**, **Media Play**, or **Source** screens, press the Controller for more than 1 second.
- When selecting a function by moving the controller backwards, forwards, left, or right, be sure not to press the controller. If you press it first, it will not operate properly when you move it.
- The product color and shape may vary depending on the model.

Standby mode

Your TV enters Standby mode when you turn it off and continues to consume a small amount of electric power. To be safe and to decrease power consumption, do not leave your TV in standby mode for long periods of time (when you are away on vacation, for example). It is best to unplug the power cord.

How to View the e-Manual

E-MANUAL



You can find instructions for your TV's features in the e-Manual in your TV. To use the e-Manual, press the **E-MANUAL** button on your remote. Move the cursor using the right/left buttons to highlight a main category. Use the up/down buttons to select a topic, and then press the **ENTER** button. The e-Manual displays the page you want to see. To change pages, use the right/left buttons.

You can also access the e-Manual through the menu:

MENU → **Support** → **e-Manual** → **ENTER**

If you want to return to the e-Manual, press the **E-MANUAL** button on your remote.

You can not use the **Try Now** function if the menu is not activated.

Screen Display

TV Screen: Displays the program, movie, video, etc. you are currently watching.

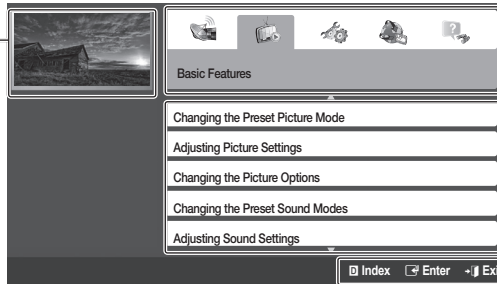

The category list. Press **◀** or **▶** button to select the category you want.

Displays the sub-menu list. Use the arrow buttons on your remote to move the cursor. Press the **ENTER** button to select the sub-menu you want.

Operation Buttons:

Blue (Index): Displays the index screen.

Enter: Select a category or sub-menu.

Exit: Exit the e-Manual.

How to toggle between an e-Manual topic and the corresponding OSD menu(s).

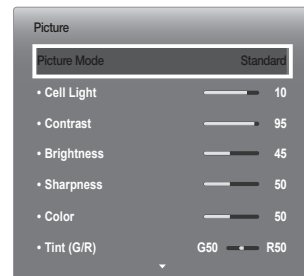
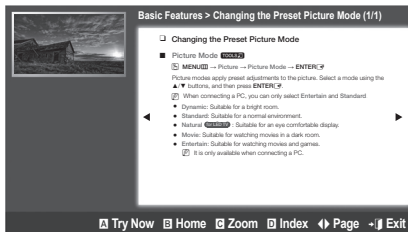

This function is not enabled in some menus.

Method 1	Method 2
<ol style="list-style-type: none"> 1. If you want to use the menu that corresponds to an e-Manual topic, press the red button to select Try Now. 2. To return to the e-Manual screen, press the E-MANUAL button. 	<ol style="list-style-type: none"> 1. Press the ENTER button when a topic is displayed. “Do you want to execute this?” appears. Select Yes, and then press the ENTER button. The OSD window appears. 2. To return to the e-Manual screen, press the E-MANUAL button.

Viewing the Contents

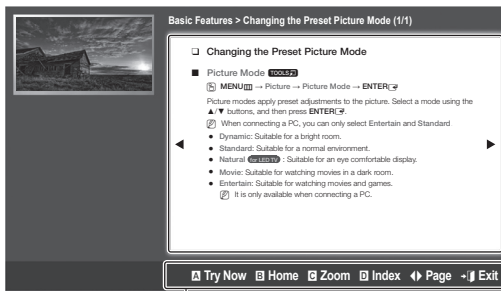

Contents Area: Contains the topic contents if you selected a sub-menu. To move to the previous or next page, press the ◀ or ▶ button.

Operation Buttons:

- ▲ Red (**Try Now**): Press to display the OSD menu that corresponds to the topic. To return to the e-Manual screen, press the E-MANUAL button.
- Green (**Home**): Moves to the e-Manual home screen.
- Yellow (**Zoom**): Magnifies a screen.
- Blue (**Index**): Displays the Index screen.
- ◀▶ (**Page**): Moves to the previous or next page.
- (Exit): Exit the e-Manual.

Using the Zoom mode

When you are viewing an e-Manual instruction page, press the ■ Yellow (**Zoom**) to magnify the screen. You can scroll through the magnified screen by using the ▲ or ▼ buttons.

✎ To return the screen to normal size, press the RETURN button.

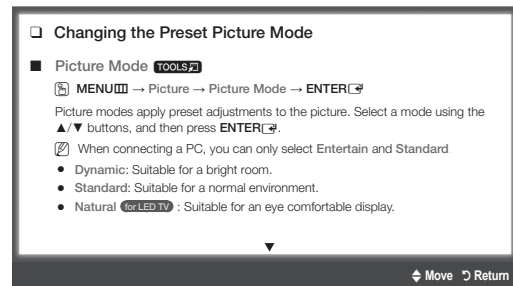

How to search for a topic on the index page

1. Press the Blue (**Index**) button on the remote. The Index screen appears.
2. To search for a topic, press the left or right arrow button to select a letter. The Index displays a list of topics and keywords that begin with the letter you selected.
3. Press the up or down arrow button to select a topic or keyword you want, and then press the ENTER button to select a topic you want to see.
4. The e-Manual page with the topic appears.

✎ To close the **Index** screen, press the RETURN button.

Troubleshooting

If the TV seems to have a problem, first review this list of possible problems and solution. Also review the Troubleshooting Section in the e-Manual. If none of the troubleshooting tips apply, visit www.samsung.com/support or call Samsung customer Service at 1-800-SAMSUNG (1-800-726-7864).

Issues	Solutions and Explanations
Flickering and Dimming	<p>If your Samsung Television is flickering or dimming sporadically, you may need to disable some of its energy efficient features like the Eco Sensor or the Energy Saving feature. Follow the steps below with your remote to turn these features off or on.</p> <ul style="list-style-type: none"> • Energy Saving: User Menu → System → Eco Solution → Energy Saving • Eco Sensor: User Menu → System → Eco Solution → Eco Sensor
Component Connections / Screen Color	<p>If you find that the color on your Samsung television's screen is not correct or black and white, first run a Self Diagnosis on the TV to make sure there are no device issues.</p> <ul style="list-style-type: none"> • Self Diagnosis: User Menu → Support → Self Diagnosis → Picture Test <p>If the problem does not appear in the Test Picture, making sure :</p> <ul style="list-style-type: none"> • Your connections are all consistent. For example, if you've used the AV In jack on your TV, make sure you have used the AV Out jack on your video source. • You have connected your devices to the correct jacks. For example, if you use the Component jacks, labeled Pb, Pr, and Y, to connect your TV and video source, make sure you have connected the blue Pb jack on the video source to the blue Pb jack on the TV, the red Pr jack on the source to the red Pr jack on the TV, and the yellow Y jack on video source to the yellow Y jack on the TV.
Screen Brightness	<p>If you find that the colors on your Samsung TV are correct but just a little too dark or bright, try adjusting the following settings in the Picture option of the Main menu:</p> <ul style="list-style-type: none"> • Cell Light, Contrast, Brightness, Sharpness, Color, Tint (G/R) and so on.
Unwanted Powering Off	<p>If your Samsung TV appears to turn off by itself, there may be an issue with either your Timer settings or your Eco friendly No Signal Power Off feature.</p> <p>First make sure the Sleep Timer is not accidentally set. The sleep timer turns the TV off after a certain period of time.</p> <ul style="list-style-type: none"> • Sleep Timer: User Menu → System → Time → Sleep Timer <p>If the Sleep Timer is not activated, you may have engaged the No Signal Power Off or Auto Power Off feature. To turn these features off, follow the steps below with your remote.</p> <ul style="list-style-type: none"> • No Signal Power Off : User Menu → System → Eco Solution → No Signal Power Off • Auto Power Off: User Menu → System → Eco Solution → Auto Power Off
Trouble Powering On	<p>Before you turn the TV on, find the red light on the bottom right or left of your TV. Press the power button on the TV or remote. The light should blink about 5 times before the TV turns on.</p> <p>If you find that you are having trouble powering on your Samsung television, there are a number of things to check before making a call to the service department.</p> <ul style="list-style-type: none"> • If you happen to be using the TV as a monitor and the stand-by light only blinks for a few seconds when you press the power button, your PC is in sleep mode. To take your PC out of sleep mode, press a key on your keyboard or move the mouse. Then try turning your TV on. <p>If you're sure your power cord, remote control, and PC are functioning properly, you may be having a cable issue. If you have a cable or satellite box, your TV may appear to be off because the cable or satellite box is not outputting a signal. To test the signal output of your cable or satellite box, press the guide or info button on the cable or satellite box remote control. If the screen displays the guide or info data, the problem is caused by the box.</p>
Cannot Find a Channel	<p>Re-run Setup (Go to Menu - System - Setup) or run Auto Program. (Go to MENU - Broadcasting - Auto Program).</p>

 For detailed troubleshooting information, watch the troubleshooting videos at www.samsung.com/spsn

Issues	Solutions and Explanations
Poor picture	First, perform the Picture Test and to see if your TV is properly displaying the test image. <ul style="list-style-type: none"> Go to MENU - Support - Self Diagnosis - Picture Test If the test image is properly displayed, the poor picture may be caused by the source or signal.
The TV image does not look as good as it did in the store.	Store displays are typically tuned to digital, HD (high definition) channels. <ul style="list-style-type: none"> If you have an analog cable/satellite box, upgrade to a digital set top box. Use HDMI or Component cables to deliver HD (high definition) picture quality. Cable/Satellite subscribers: Try HD channels from the channel line up. Air/Cable Antenna connection: Try HD channels after performing an Auto program. <ul style="list-style-type: none"> Many HD channel programs are up scaled from SD (Standard Definition) content. Look for a channel that is broadcasting true HD content. Adjust the Cable/Set top box video output resolution to 1080i or 720p.
The picture is distorted: macroblock error, small block, dots, pixelization.	<ul style="list-style-type: none"> The compression of video contents may cause picture distortion, especially in programs with fast moving pictures such as sports programs and action movies. A weak signal can cause picture distortion. This is not a TV problem. Mobile phones used close to the TV (within 3.3 ft) may cause noise in the picture on analog and digital channels.
Color is wrong or missing.	<ul style="list-style-type: none"> If you're using a Component connection, make sure the component cables are connected to the correct jacks. Incorrect or loose connections may cause color problems or a blank screen.
There is poor color or brightness.	<ul style="list-style-type: none"> Adjust the Picture options in the TV menu. (go to Picture Mode / Color / Brightness / Sharpness) Adjust the Energy Saving option in the TV menu (go to MENU - System - Eco Solution - Energy Saving) Try resetting the picture to the default picture settings. (go to MENU - Picture - Reset Picture)
There is a dotted line on the edge of the screen.	<ul style="list-style-type: none"> If the picture size is set to Screen Fit, change it to 16:9. Change the cable/satellite box resolution.
The picture is black and white.	<ul style="list-style-type: none"> If you are using an AV composite input, connect the video cable (yellow) to the Green jack of Component input 1 on the TV.
When changing channels, the picture freezes or is distorted or delayed.	<ul style="list-style-type: none"> If the TV is connected to a cable box, reset the box. (Disconnect and then reconnect the AC cord, and then wait until the cable box reboots. It may take up to 20 minutes.) Set the output resolution of the cable box to 1080i or 720p.
Sound Problem	First, perform the Sound Test to determine if your TV audio is operating properly. <ul style="list-style-type: none"> Go to MENU - Support - Self Diagnosis - Sound Test If the audio is OK, the sound problem may be caused by the source or signal.
There is no sound or the sound is too low at maximum volume.	<ul style="list-style-type: none"> Please check the volume of the device (Cable/Sat Box, DVD, Blu-ray, etc.) connected to your TV.
The picture is good but there is no sound.	<ul style="list-style-type: none"> Set the Speaker Select option to TV Speaker in the Sound menu. If you are using an external device, check the device's audio output option (Ex. You may need to change your cable box's audio option to HDMI if you have the box connected to your TV using an HDMI cable.). If you are using a DVI to HDMI cable, a separate audio cable is required. Reboot the connected device by disconnecting and then reconnecting the device's power cable.
The speakers are making an inappropriate noise.	<ul style="list-style-type: none"> Check the cable connections. Make sure a video cable is not connected to an audio input. For Antenna or Cable connections, check the signal information. A weak signal may cause sound distortion. Perform the Sound Test as explained above.

Issues	Solutions and Explanations
No Picture, No Video	
The TV will not turn on.	<ul style="list-style-type: none"> • Make sure the AC power cord is securely plugged into the wall outlet and the TV. • Make sure the wall outlet is working. • Try pressing the POWER button on the TV to make sure the problem is not the remote control. If the TV turns on, refer to 'Remote control does not work' below.
The TV turns off automatically.	<ul style="list-style-type: none"> • Ensure the Sleep Timer is set to Off in the System menu. • If your PC is connected to the TV, check your PC's power settings. • Make sure the AC power cord is plugged in securely to the wall outlet and the TV. • When you are watching TV programs from an antenna, the TV will turn off after 10 - 15 minutes if there is no signal.
There is no picture/video.	<ul style="list-style-type: none"> • Check the cable connections. (Remove and reconnect all cables connected to the TV and external devices). • Set your external device's (Cable/Sat Box, DVD, Blu-ray etc) video outputs to match the connections to the TV input. For example, if an external device's output is HDMI, it should be connected to an HDMI input on the TV. • Make sure your connected devices are powered on. • Be sure to select the TV's correct source by pressing the SOURCE button on the remote control. • Reboot the connected device by disconnecting and then reconnecting the device's power cable.
Antenna(Air / Cable) Connection	
The TV is not receiving all channels.	<ul style="list-style-type: none"> • Make sure the coaxial cable is connected securely. • Run Auto Program to add available channels to the channel list. There are 3 options, STD, HRC and IRC. Most cable systems use STD. • Verify the antenna is positioned correctly.
No Caption on digital channels.	<ul style="list-style-type: none"> • Check the Caption Setup menu. Try changing Caption Mode Service1 to CC1. • Some channels may not have caption data.
The picture is distorted: macroblock, error, small block, dots, pixelization.	<ul style="list-style-type: none"> • The compression of video contents may cause picture distortion, especially in programs with fast moving pictures such as sports programs and action movies. • A weak signal can cause picture distortion. This is not a TV problem.
Others	
Purple/green rolling horizontal bars and buzzing noise from the TV speakers with Component cable connection.	<ul style="list-style-type: none"> • Remove the left and right audio connections from the set-top-box. If the buzzing stops, this indicates that the set-top-box has a grounding issue. Replace the Component video cables with an HDMI connection.
Plasma TV is making humming noise.	<ul style="list-style-type: none"> • Plasma TVs typically make a soft humming sound. This is normal. It's caused by the electrical charges that are used to create the images on the screen. • If the humming sound is loud, you may have set the brightness on the TV too high. Try setting the brightness lower. • You can also have loud humming if the back of your Plasma TV is too close to a wall or other hard surface. Also try rerouting your connection cables. • Improper installation of the wall mount can create excessive noise.

Issues	Solutions and Explanations
The picture will not display in full screen.	<ul style="list-style-type: none"> • HD channels will have black bars on either side of the screen when displaying up scaled SD (4:3) contents. • Black bars will appear on the top and bottom of the screen when you watch movies that have aspect ratios different from your TV. • Adjust the picture size option on your external device or change the TV to full screen.
Image Retention (Burn In) Issue.	<ul style="list-style-type: none"> • To minimize the possibility of screen burn, this unit is equipped with Pixel Shift screen burn reduction technology. Pixel Shift lets you set the picture so it moves slightly up and down (Vertical Line) and side to side (Horizontal Dot). The regular, slight movement of the picture reduces screen burn in.
The remote control does not work.	<ul style="list-style-type: none"> • Replace the remote control batteries. Make sure you insert them with the plus and minus ends in the correct direction. • Clean the transmission window located on the top of the remote control. • Try pointing the remote control directly at the TV from 5-6 feet away.
The cable/set top box remote control does not turn the TV on or off, or adjust the volume.	<ul style="list-style-type: none"> • Program the Cable/Set top box remote control to operate the TV. Refer to the Cable/Set top box user manual for the SAMSUNG TV code.
A " Mode Not Supported " message appears.	<ul style="list-style-type: none"> • Check the supported resolution of the TV and adjust the external device's output resolution accordingly. Refer to resolution settings in this manual.
Caption on the TV menu is greyed out.	<ul style="list-style-type: none"> • You cannot select Caption in the TV menu when watching content from a device connected via HDMI or Component. • Caption must be activated on the external device.
There is a plastic smell from the TV.	<ul style="list-style-type: none"> • This smell is normal and will dissipate over time.
TV Signal Information is unavailable in the Self Diagnosis Test menu.	<ul style="list-style-type: none"> • This function is only available for digital channels the TV receives from an Antenna / RF/ Coax connection.
TV is tilted to the right or left side.	<ul style="list-style-type: none"> • Remove the stand base from the TV and reassemble it.
The Broadcasting menu is greyed out (unavailable).	<ul style="list-style-type: none"> • The Broadcasting menu is only available when you select the TV source.
Your settings are lost after 30 minutes or every time the TV is turned off.	<ul style="list-style-type: none"> • If TV is in the Store Demo mode, it will reset audio and picture settings every 30 minutes. If you want to change the settings from Store Demo mode to Home Use, press the SOURCE button to select TV mode, and go to MENU → Support → Use Mode.
You have intermittent loss of audio or video.	<ul style="list-style-type: none"> • Check the cable connections and reconnect them. • Loss of audio or video can be caused by using overly rigid or thick cables. Make sure the cables are flexible enough for long term use. If mounting the TV to the wall, we recommend using cables with 90 degree connectors.
The PIP menu is not available.	<ul style="list-style-type: none"> • PIP functionality is only available when you are using an HDMI or Component source.
You see small particles when you look closely at the edge of the frame of the TV.	<ul style="list-style-type: none"> • This is part of the product's design and is not a defect.
The POP (the TV's internal banner ad) appears on the screen.	<ul style="list-style-type: none"> • Go to MENU → Support → Use Mode, and then select Home Use.
The message " This file may not be played properly. " appears.	<ul style="list-style-type: none"> • This may appear because the content has a high bit rate. The content generally will play, but could experience some playability issues.

 Some functions and pictures shown in this manual are available on specific models only.

 To keep your TV in optimum condition, upgrade to the latest firmware on the Samsung web site by USB (Go to samsung.com → Support).

Installing the Wall Mount (Optional)



Wall or Ceiling Mounting

If you mount this product on a wall, it should be mounted only as recommended by the manufacturer. Unless it is correctly mounted, the product may slide or fall, causing serious injury to a child or adult, and serious damage to the product.

Installing the Wall Mount Kit

The wall mount kit (sold separately) lets you mount the TV on the wall. For detailed information about installing the wall mount, see the instructions provided with the wall mount. Contact a technician for assistance when installing the wall mount bracket. Samsung Electronics is not responsible for any damage to the product or injury to yourself or others if you elect to install the wall mount on your own. To order the wall mount, contact Samsung Customer Care at 1-800-SAMSUNG (1-800-726-7864).

Wall Mount Kit Specifications (VESA)

Install your wall mount on a solid wall perpendicular to the floor. Before attaching the wall mount to surfaces other than plaster board, please contact your nearest dealer for additional information. If you install the TV on a ceiling or slanted wall, it may fall and result in severe personal injury.

NOTE

- Standard dimensions for wall mount kits are shown in the table below.
- Samsung wall mount kits contain a detailed installation manual and all parts necessary for assembly are provided.
- Do not use screws that do not comply with the VESA standard screw specifications.
- Do not use screws that are longer than the standard length or do not comply with the VESA standard screw specifications. Screws that are too long may cause damage to the inside of the TV set.
- For wall mounts that do not comply with the VESA standard screw specifications, the length of the screws may differ depending on the wall mount specifications.
- Do not fasten the screws too firmly. This may damage the product or cause the product to fall, leading to personal injury. Samsung is not liable for these kinds of accidents.
- Samsung is not liable for product damage or personal injury when a non-VESA or non-specified wall mount is used or the consumer fails to follow the product installation instructions.
- Do not mount the TV at more than a 15 degree tilt.
- Always have two people mount the TV on a wall.

Product Family	TV size in inches	VESA screw hole specs (A * B) in millimeters	Standard Screw	Quantity
PDP-TV	43-51	400 X 400	M8	4
	60-64	600 X 400		

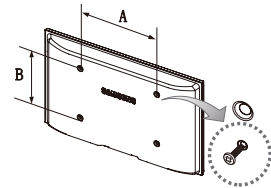

Remove the screws in the mounting holes before you install the wall mount.



Do not install your Wall Mount Kit while your TV is turned on. It may result in personal injury due to electric shock.

Securing the TV to the Wall



Caution: Pulling, pushing, or climbing on the TV may cause the TV to fall. In particular, ensure your children do not hang over or destabilize the TV. Doing so may cause the TV to tip over, causing serious injuries or death. Follow all safety precautions provided in the included Safety Flyer with your TV. For added stability and safety, you can purchase and install the anti-fall device as described below.

The TV-Holder Kit (Sold Separately):

The parts below are included in the TV Holder kit. In addition, you need to provide a wood screw, a screw and molly, or other screw appropriate for the wall or cabinet you intend to secure the TV-Holder string to. We recommend a size M4xL20 wood screw.



TV-Holder (BN96-15753A)







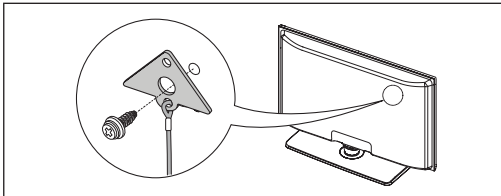

Screw (M8 X L19)

Installing the TV-Holder

1. Remove the screw attached to the back of your TV, and then connect the TV-Holder to the TV with the screw included in the TV-Holder Kit that is designated for your TV.

 Make sure to use only the appropriate supplied screw. If you use a different screw, you can damage your TV.



2. Firmly fasten the screw you provided (size M4 x L20 or similar) to the wall or cabinet where the TV is to be installed.
 -  If you fasten the screw to the wall, we recommend you drive the screw into a stud. If that is not possible, use a molly to anchor the screw.
3. Tie the TV-Holder cord to the screw fastened to the wall or cabinet so that the TV is fixed. See the illustrations below.
 -  Install the TV close to the wall so that it does not fall.
 -  When attaching the TV-Holder cord to the wall, tie the cord level with the ground or slanted downwards for safety purposes.
 -  Check the cord occasionally to make sure it is secure.
 -  Before moving the TV, separate the connected cord first.

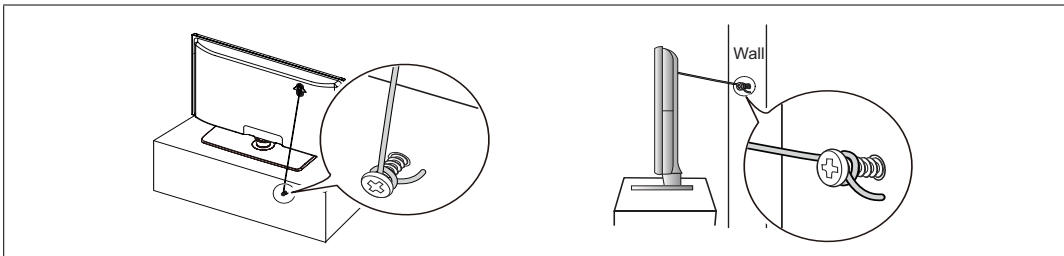

4. Verify all connections are properly secured. Periodically check the connections for any sign of fatigue or failure. If you have any doubt about the security of your connections, contact a professional installer.

To purchase the TV-Holder Kit, contact Samsung Customer Care

 In the United States: 1-800-SAMSUNG (1-800-726-7864)

 In Canada: 1-800-SAMSUNG (1-800-726-7864)

Anti-theft Kensington Lock

A Kensington Lock is a device you can use to physically fix your TV in place when using it in a public place. You wrap the Kensington Lock's cable around a large, immobile object and then attach the lock to the Kensington slot on the back of the TV.

The appearance and locking method may differ from the illustration below depending on the manufacturer. Refer to the manual provided with the Kensington Lock for additional information on proper use. The Kensington Lock is not supplied by Samsung.

- ✎ Please find a "K" icon on the rear of the TV. A Kensington slot is beside the "K" icon.
- ✎ The position and color may differ depending on the model.

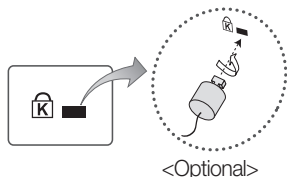

To lock the product, follow these steps:

1. Wrap the Kensington lock cable around a large, stationary object such as desk or chair.
2. Slide the end of the cable with the lock attached through the looped end of the Kensington lock cable.
3. Insert the locking device into the Kensington slot on the product.
4. Lock the lock.

- ✎ These are general instructions. For exact instructions, see the User manual supplied with the locking device.
- ✎ The locking device has to be purchased separately.

Storage and Maintenance

- ✎ If a sticker was attached to the TV screen, some debris can remain after you remove the sticker. Please clean the debris off before watching TV.
- ✎ The exterior and screen of the product can get scratched during cleaning. Be sure to wipe the exterior and screen carefully using the cloth provided or a soft cloth to prevent scratches.



Do not spray water directly onto the product. Any liquid that goes into the product may cause a failure, fire, or electric shock.



Clean the product with a soft cloth dipped in a small amount of water. Do not use a flammable liquid (e.g. benzene, thinners) or a cleaning agent.

License



Manufactured under license from Dolby Laboratories. Dolby and the double-D symbol are trademarks of Dolby Laboratories.



Manufactured under a license from U.S. Patent No's: 5,956,674, 5,974,380, 5,978,762, 6,487,535, 6,226,616, 7,212,872, 7,003,467, 7,272,567, 7,668,723, 7,392,195, 7,930,184, 7,333,929 and 7,548,853. DTS, the Symbol, and DTS and the Symbol together are registered trademarks & DTS Premium Sound | 5.1 is a trademark of DTS, Inc. ©2012 DTS, Inc. All Rights Reserved.



Manufactured under a license from U.S. Patent No's: 6,285,767, 8,027,477, 5,319,713, 5,333,201, 5,638,452, 5,771,295, 5,970,152, 5,912,976, 7,200,236, 7,492,907, 8,050,434, 7,720,240, 7,031,474, 7,907,736 and 7,764,802. DTS, the Symbol, and DTS and the Symbol together are registered trademarks & DTS Studio Sound is a trademark of DTS, Inc. ©2012 DTS, Inc. All Rights Reserved.



The terms HDMI and HDMI High-Definition Multimedia Interface, and the HDMI Logo are trademarks or registered trademarks of HDMI Licensing LLC in the United States and other countries.



DivX Certified® to play DivX® video up to HD 1080p, including premium content.

ABOUT DIVX VIDEO: DivX® is a digital video format created by DivX, LLC, a subsidiary of Rovi Corporation. This is an official DivX Certified® device that plays DivX video. Visit divx.com for more information and software tools to convert your files into DivX videos.

ABOUT DIVX VIDEO-ON-DEMAND: This DivX Certified® device must be registered in order to play purchased DivX Video-on-Demand (VOD) movies. To obtain your registration code, locate the DivX VOD section in your device setup menu. Go to vod.divx.com for more information on how to complete your registration. Covered by one or more of the following U.S. patents : 7,295,673; 7,460,668; 7,515,710; 7,519,274
DivX®, DivX Certified® and associated logos are trademarks of Rovi Corporation or its subsidiaries and are used under license.





Open source license notice

In the case of using open source software, Open Source Licenses are available on the product menu.
Open Source License Notice is written only English.

Specifications

Environmental Considerations Operating Temperature Operating Humidity Storage Temperature Storage Humidity	50°F to 104°F (10°C to 40°C) 10% to 80%, non-condensing -4°F to 113°F (-20°C to 45°C) 5% to 95%, non-condensing	
Model Name	PN43F4500 PN43F4550	PN51F4500 PN51F4550
Display Resolution	1024 X 768	
Screen Size (Diagonal)	43" Class (43.0 measured diagonally)	51" Class (50.6 measured diagonally)
Sound (Output)	10W x 2	
Dimensions (W x H x D) Body With stand	39.7 x 24.3 x 2.1 inches (1009.7 x 617.5 x 55.7 mm) 39.7 x 27.5 x 9.2 inches (1009.7 x 698.8 x 235.0 mm)	46.6 x 27.6 x 2.1 inches (1185.2 x 702.1 x 55.7 mm) 46.6 x 30.8 x 9.2 inches (1185.2 x 783.0 x 235.0 mm)
Weight Without Stand With Stand	29.9lbs (13.6kg) 33.0lbs (15.0kg)	39.0lbs (17.7kg) 42.1lbs (19.1kg)

Model Name	PN51F5300 PN51F5350	PN60F5300 PN60F5350	PN64F5300 PN64F5350
Stand Swivel (Left / Right)	-20° ~ 20°		
Display Resolution	1920 X 1080	1920 x 1080 (Black & White)	1920 X 1080
Screen Size (Diagonal)	51" Class (50.7 measured diagonally)	60" Class (59.9 measured diagonally)	64" Class (64.0 measured diagonally)
Sound (Output)	10W x 2		
Dimensions (W x H x D) Body With stand	46.6 x 27.6 x 2.1 inches (1185.2 x 702.1 x 55.7 mm) 46.6 x 31.1 x 12.0 inches (1185.2 x 792.1 x 307.2 mm)	54.6 x 32.4 x 2.1 inches (1388.3 x 823.3 x 55.7 mm) 54.6 x 36.3 x 14.7 inches (1388.3 x 924.1 x 375.5 mm)	58.1 x 34.2 x 2.1 inches (1478.0 x 870.0 x 55.7 mm) 58.1 x 38.0 x 14.7 inches (1478.0 x 967.0 x 375.5 mm)
Weight Without Stand With Stand	39.2lbs (17.8kg) 43.2lbs (19.6kg)	58.8lbs (26.7kg) 64.5lbs (29.3kg)	70.9lbs (32.2kg) 76.5lbs (34.8kg)

-  Design and specifications are subject to change without prior notice.
-  This device is a Class B digital apparatus.
-  For information about the power supply and more information about power consumption, refer to the label attached to the product.
-  Typical power consumption is measured according to Energy Star Program requirements for Televisions.

Dispose unwanted electronics through an approved recycler.
To find the nearest recycling location, go to our website:
www.samsung.com/recyclingdirect or call, (877) 278 - 0799

JACK PANEL DETAIL / REAR VIEW

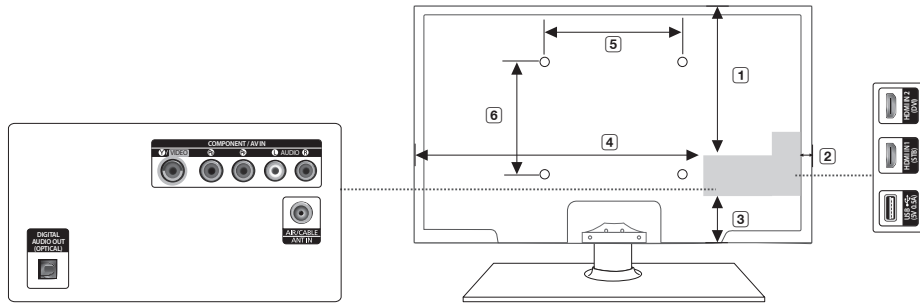

(Unit: inches)

Model name	①	②	③	④	⑤	⑥
PN43F4500/PN43F4550	16.8	1.3	2.5	28.4	15.7	15.7
PN51F4500/PN51F4550	19.5	1.4	3.1	35.0	15.7	15.7
PN51F5300/PN51F5350	19.5	1.4	3.1	35.0	15.7	15.7
PN60F5300/PN60F5350/	20.4	1.0	6.7	42.0	23.6	15.7
PN64F5300/PN64F5350	21.8	1.7	6.9	42.8	23.6	15.7

NOTE: All drawings are not necessarily to scale. Some dimensions are subject to change without prior notice. Refer to the dimensions prior to performing installation of your TV. Not responsible for typographical or printed errors.

© 2013 Samsung Electronics America, Inc

Supported Videos Formats

File Extension	Container	Video Codec	Resolution	Frame rate (fps)	Bit rate (Mbps)	Audio Codec
*.avi / *.mkv *.asf / *.wmv *.mp4 / *.3gp *.vro / *.mpg *.mpeg / *.ts *.tp / *.trp *.mov / *.flv *.vob / *.svi *.divx	AVI	DivX 3.11/4.x/5.x/6.x	1920 x 1080	6-30	30	AC3 LPCM ADPCM (IMA, MS) AAC HE-AAC WMA DD+ MPEG (MP3) DTS (Core) G.711(A-Law, μ-Law)
	MKV	MPEG4 SP/ASP				
	ASF	H.264 BP/MP/HP				
	MP4	Motion JPEG	640 x 480		8	
	3GP		1920 x 1080		30	
	MOV	Window Media Video v9				
	FLV	MPEG2				
VRO	MPEG1					
VOB	WebM	VP8	1920 x 1080	20	Vorbis	
PS						
TS						

Other Restrictions

- Video content will not play, or not play correctly, if there is an error in the content or the container.
- Sound or video may not work if the contents have a standard bit rate/frame rate above the compatible Frame/sec listed in the table.
- If the Index Table is in error, the Seek (Jump) function is not supported.
- Some USB/digital camera devices may not be compatible with the player.
- The menu may display slowly if the video you are watching has a bit rate over 10Mbps.

Video decoder	Audio decoder
<ul style="list-style-type: none"> • Supports up to H.264, Level 4.1 (FMO/ASO/RS are not supported.) • Frame rate : - Below 1280 x 720: 60 frame max - Above 1280 x 720: 30 frame max • VC1 AP L4 is not supported. • GMC 2 or higher is not supported. 	<ul style="list-style-type: none"> • WMA 10 Pro supports up to 5.1 channel and M2 profile. • WMA lossless audio is not supported. • Vorbis supports up to 2ch. • DD+ supports up to 5.1 channel.

Supported Subtitle Formats

- External

Name	File extension
MPEG-4 timed text	.txt
SAMI	.smi
SubRip	.srt
SubViewer	.sub
Micro DVD	.sub or .txt
SubStation Alpha	.ssa
Advanced SubStation Alpha	.ass
Powerdivx	.psb

- Internal

Name	Container	Format
Xsub	AVI	Picture Format
SubStation Alpha	MKV	Text Format
Advanced SubStation Alpha	MKV	Text Format
SubRip	MKV	Text Format
MPEG-4 Timed text	MP4	Text Format

Supported Photos Formats

File Extension	Type	Resolution
*.jpg *.jpeg	JPEG	15360 X 8640
*.bmp	BMP	4096 X 4096
*.mpo	MPO	15360 X 8640

 The MPO type file does not support Zoom, Rotate and Slide Show Effect functions.

Supported Music Formats

File Extension	Type	Codec	Remark
*.mp3	MPEG	MPEG1 Audio Layer 3	
*.m4a *.mpa *.aac	MPEG4	AAC	
*.flac	FLAC	FLAC	Supports up to 2ch.
*.ogg	OGG	Vorbis	Supports up to 2ch.
*.wma	WMA	WMA	WMA 10 Pro supports up to 5.1 channel and M2 profile. (WMA lossless audio is not supported.)
*.wav	wav	wav	
*.mid *.midi	midi	midi	type 0 and type 1

Important Warranty Information Regarding Television Format Viewing

 See the warranty card for more information on warranty terms.

Wide screen format PDP Displays (with 16:9 aspect ratios, the ratio of the screen width to height) are primarily designed to view wide screen format full-motion video. The images displayed on them should primarily be in the wide screen 16:9 ratio format, or expanded to fill the screen if your model offers this feature, with the images constantly in motion. Displaying stationary graphics and images on the screen, such as the dark sidebars on non-expanded standard format television video and programming, should be limited to no more than 5% of the total television viewing per week.

Additionally, viewing other stationary images and text such as stock market crawls, video game displays, station logos, web sites or computer graphics and patterns, should be limited as described above for all televisions. Displaying stationary images for more than 5% of total viewing time can cause uneven aging of your PDP display and leave subtle, but permanent burned-in ghost images in the PDP picture. To avoid this, vary the programming and images, and primarily display full screen moving images, not stationary patterns or dark bars. On PDP models that offer picture sizing features, use these controls to view different formats as a full screen picture.

Be careful in the selection of television formats you use for viewing and the amount of time you view them. Uneven PDP aging as a result of format selection and use, as well as burned in images, are not covered by your Samsung limited warranty.

- SAMSUNG ELECTRONICS NORTH AMERICAN LIMITED WARRANTY STATEMENT

Subject to the requirements, conditions, exclusions and limitations of the original Limited Warranty supplied with Samsung Electronics (SAMSUNG) products, and the requirements, conditions, exclusions and limitations contained herein, SAMSUNG will additionally provide Warranty Repair Service in the United States on SAMSUNG products purchased in Canada, and in Canada on SAMSUNG products purchased in the United States, for the warranty period originally specified, and to the Original Purchaser only.

The above described warranty repairs must be performed by a SAMSUNG Authorized Service Center. Along with this Statement, the Original Limited Warranty Statement and a dated Bill of Sale as Proof of Purchase must be presented to the Service Center.

Transportation to and from the Service Center is the responsibility of the purchaser. Conditions covered are limited only to manufacturing defects in material or workmanship, and only those encountered in normal use of the product.

Excluded, but not limited to, are any originally specified provisions for, in-home or on-site services, minimum or maximum repair times, exchanges or replacements, accessories, upgrades, options, or consumables.

For the location of a SAMSUNG Authorized Service Center, please call toll-free:

– In the United States : 1-800-SAMSUNG (1-800-726-7864)

– In Canada : 1-800-SAMSUNG

Warranty Information

SAMSUNG BRAND PRODUCTS

LIMITED WARRANTY TO ORIGINAL PURCHASER

This SAMSUNG brand product, as supplied and distributed by SAMSUNG and delivered new, in the original carton to the original consumer purchaser, is warranted by SAMSUNG against manufacturing defects in materials and workmanship for a limited warranty period of 90 Days Parts and Labor for Commercial Use

Categories	Parts	Labor	Size	Service
LCD/LED TV	1 Year	1 Year	40"and Larger	Carry-In or In Home
			37"and Smaller	Carry-In
Plasma Display	1 Year	1 Year	All	Carry-In or In Home
Projector (Excluding Lamp **)	2 Year	2 Year	All	Carry-In or Pick up
PICO & LED Pocket Projector	1 Year	1 Year	All	Carry-In or Pick up

** 180 Days after Purchasing and 600 Hours of Use Lamp on Projector
This limited warranty begins on the original date of purchase, and is valid only on products purchased and used in the United States. To receive warranty service, the purchaser must contact SAMSUNG for problem determination and service procedures. Warranty service can only be performed by a SAMSUNG authorized service center. The original dated bill of sale must be presented upon request as proof of purchase to SAMSUNG or SAMSUNG's authorized service center.

SAMSUNG will repair or replace this product, at our option and at no charge as stipulated herein, with new or reconditioned parts or products if found to be defective during the limited warranty period specified above. All replaced parts and products become the property of SAMSUNG and must be returned to SAMSUNG. Replacement parts and products assume the remaining original warranty, or ninety (90) days, whichever is longer.

Certain products are eligible for In-home service at Samsung's discretion. To receive in-home service, the product must be unobstructed and accessible to service personnel. If during in-home service, repair cannot not be completed, it may be necessary to remove, repair and return the product. If in-home service is unavailable, SAMSUNG may elect, at our option, to provide for transportation of our choice to and from a SAMSUNG authorized service center. Otherwise, and for 37" and smaller LCD/LED TV, transportation to and from the SAMSUNG authorized service center is the responsibility of the purchaser.

This limited warranty covers manufacturing defects in materials and workmanship encountered in normal, and except to the extent otherwise expressly provided for in this statement, noncommercial use of this product, and shall not apply to the following, including, but not limited to: damage which occurs in shipment; delivery and installation; applications and uses for which this product was not intended; altered product or serial numbers; cosmetic damage or exterior finishes; accidents, abuse, neglect, fire, water, lightning or other acts of nature; use of products, equipment, systems, utilities, services, parts, supplies, accessories, applications, installations, repairs, external wiring or connectors not supplied or authorized by SAMSUNG which damage this product or result in service problems; incorrect electrical line voltage, fluctuations and surges; customer adjustments and failure to follow operating instructions, cleaning, maintenance and environmental instructions that are covered and prescribed in the instruction book; reception problems and distortion related to noise, echo, interference or other signal transmission and delivery problems; brightness related to normal aging, or burned-in images. SAMSUNG does not warrant uninterrupted or error-free operation of the product.

THERE ARE NO EXPRESS WARRANTIES OTHER THAN THOSE LISTED AND DESCRIBED ABOVE, AND NO WARRANTIES WHETHER EXPRESS OR IMPLIED, INCLUDING, BUT NOT LIMITED TO, ANY IMPLIED WARRANTIES OF MERCHANTABILITY OR FITNESS FOR A PARTICULAR PURPOSE, SHALL APPLY AFTER THE EXPRESS WARRANTY PERIODS STATED ABOVE, AND NO OTHER EXPRESS WARRANTY OR GUARANTY GIVEN BY ANY PERSON, FIRM OR CORPORATION WITH RESPECT TO THIS PRODUCT SHALL BE BINDING ON SAMSUNG. SAMSUNG SHALL NOT BE LIABLE FOR LOSS OF REVENUE OR PROFITS, FAILURE TO REALIZE SAVINGS OR OTHER BENEFITS, OR ANY OTHER SPECIAL, INCIDENTAL OR CONSEQUENTIAL DAMAGES CAUSED BY THE USE, MISUSE OR INABILITY TO USE THIS PRODUCT, REGARDLESS OF THE LEGAL THEORY ON WHICH THE CLAIM IS BASED, AND EVEN IF SAMSUNG HAS BEEN ADVISED OF THE POSSIBILITY OF SUCH DAMAGES. NOR SHALL RECOVERY OF ANY KIND AGAINST SAMSUNG BE GREATER IN AMOUNT THAN THE PURCHASE PRICE OF THE PRODUCT SOLD BY SAMSUNG AND CAUSING THE ALLEGED DAMAGE. WITHOUT LIMITING THE FOREGOING, PURCHASER ASSUMES ALL RISK AND LIABILITY FOR LOSS, DAMAGE OR INJURY TO PURCHASER AND PURCHASER'S PROPERTY AND TO OTHERS AND THEIR PROPERTY ARISING OUT OF THE USE, MISUSE OR INABILITY TO USE THIS PRODUCT SOLD BY SAMSUNG NOT CAUSED DIRECTLY BY THE NEGLIGENCE OF SAMSUNG. THIS LIMITED WARRANTY SHALL NOT EXTEND TO ANYONE OTHER THAN THE ORIGINAL PURCHASER OF THIS PRODUCT, IS NONTRANSFERABLE AND STATES YOUR EXCLUSIVE REMEDY.

Some states do not allow limitations on how long an implied warranty lasts, or the exclusion or limitation of incidental or consequential damages, so the above limitations or exclusions may not apply to you. This warranty gives you specific legal rights, and you may also have other rights which vary from state to state. To obtain warranty service, please contact SAMSUNG at:

Samsung Electronics America, Inc.

85 Challenger Road

Ridgefield Park, NJ 07660-2112

1-800-SAMSUNG (7267864) – www.samsung.com

1-800-749-0260: Projectors only

Important Warranty Information Regarding

IMPORTANT WARRANTY INFORMATION REGARDING TELEVISION FORMAT VIEWING

Standard screen format televisions (4:3, the aspect ratio of the screen width to height) are primarily designed to view standard format full-motion video.

The images displayed on them should primarily be in the standard 4:3 ratio format and be constantly moving. Displaying stationary graphics and images on-screen, such as the dark top and bottom letterbox bars (wide screen pictures), should be limited to no more than 15% of the total television viewing per week.

Wide screen format televisions (16:9, the aspect ratio of the screen width to height) are primarily designed to view wide screen format full-motion video. The images displayed on them should primarily be in the wide screen 16:9 ratio format, or expanded to fill the screen if your model offers this feature, and constantly moving. Displaying stationary graphics and images on screen, such as the dark side-bars on non-expanded standard format television video and programming, should be limited to no more than 15% of the total television viewing per week.

Additionally, viewing other stationary images and text such as stock market reports, video game displays, station logos, web sites or computer graphics and patterns, should be limited as described above for all televisions. Displaying any stationary images that exceed the above guidelines can cause uneven aging of Plasma Display Panels that leave subtle, but permanent burned-in ghost images in the television picture. To avoid this, vary the programming and images, and primarily display full screen moving images, not stationary patterns or dark bars. On television models that offer picture sizing features, use these controls to view the different formats as a full screen picture.

Be careful in the selection and duration of television formats used for viewing. Uneven aging as a result of format selection and use, as well as other burned-in images, is not covered by your Samsung limited warranty.

Free Manuals Download Website

<http://myh66.com>

<http://usermanuals.us>

<http://www.somanuals.com>

<http://www.4manuals.cc>

<http://www.manual-lib.com>

<http://www.404manual.com>

<http://www.luxmanual.com>

<http://aubethermostatmanual.com>

Golf course search by state

<http://golfingnear.com>

Email search by domain

<http://emailbydomain.com>

Auto manuals search

<http://auto.somanuals.com>

TV manuals search

<http://tv.somanuals.com>