



Contact SAMSUNG WORLDWIDE

If you have any questions or comments relating to Samsung products, please contact the SAMSUNG customer care centre.

Country	Customer Care Centre ☎	Web Site
EIRE	0818 717 100	www.samsung.com/ie
U.K	0845 SAMSUNG (7267864)	www.samsung.com/uk

SERIES
5

LCD TV user manual

imagine the possibilities

Thank you for purchasing this Samsung product.
To receive more complete service, please register
your product at

www.samsung.com/register

Model _____ Serial No. _____



BN68-01893J-00

Information on Use

Precautions When Displaying a Still Image

A still image may cause permanent damage to the TV screen.

- Do not display a still image and partially still image on the LCD panel for more than 2 hours as it can cause screen image retention. This image retention is also known as screen burn. To avoid such image retention, reduce the degree of brightness and contrast of the screen when displaying a still image.
-  Watching the LCD TV in 4:3 format for a long period of time may leave traces of borders displayed on the left, right and centre of the screen caused by the difference of light emission on the screen. Playing a DVD or a game console may cause a similar effect to the screen. Damages caused by the above effect are not covered by the Warranty.
- Displaying still images from Video games and PC for longer than a certain period of time may produce partial after-images. To prevent this effect, reduce the 'brightness' and 'contrast' when displaying still images.

■ WARNINGS:

Image retention, commonly known as screen burn-in, can occur on most types of television if the same image is displayed continuously. The most common causes of image retention are logos that remain stationary on the TV screen. These logos are common on many programmes received via a Set-top Box.

To reduce this risk, avoid displaying still images for long durations and lower the brightness or contrast settings to decrease the intensity of the picture. Extended viewing of movies and programs in aspect ratios that are different from the aspect ratio of the TV may cause image retention. Always endeavour to avoid black borders top or bottom by using the zoom function. This will help eliminate the black borders and fit the picture to the entire area of the screen. Using a video game console may cause image retention and is not recommended. When using a PC input, avoid displaying still images for long durations and reduce the brightness or contrast settings to decrease the intensity of the picture.



■ IMPORTANT:

Image retention issues are not covered by your Samsung® warranty.

Digital TV (DVB-T) Notice

- **FUNCTIONALITIES RELATED TO DIGITAL TV (DVB) ARE ONLY AVAILABLE IN COUNTRIES OR AREAS WHERE DVBT (MPEG2 AND MPEG4 AVC) DIGITAL TERRESTRIAL SIGNALS ARE BROADCAST.** DVB-T is the European consortium standard for the broadcast transmission of digital terrestrial television. Please check with your local dealer about the availability of DVB-T service in your area.
- Although this TV set meets the current DVB-T standards as of [August, 2008], compatibility with future DVB-T digital terrestrial broadcast cannot be guaranteed.
- Some Digital TV functions may not be available or operate correctly in some countries or regions.
- For more information, please contact your local SAMSUNG customer care centre.

Trademark & Label License Notice

	<p>TruSurround HD, SRS and  symbol are trademarks of SRS Labs, Inc. TruSurround HD technology is incorporated under license from SRS Labs, Inc.</p>
	<p>Manufactured under license from Dolby Laboratories. Dolby and the double-D symbol are trademarks of Dolby Laboratories.</p>

Symbol

	<p>Note</p>
	<p>One-Touch Button</p>
	<p>TOOL Button</p>
	<p>Press</p>

© 2009 Samsung Electronics Co., Ltd. All rights reserved.

Contents

Getting Started

- 5 Installing the Stand
- 5 Installing the Wall Mount Kit
- 5 Anti-Theft Kensington Lock
- 6 Securing the Installation Space
- 7 Securing the TV to the Wall
- 8 Accessories
- 8 Viewing the Control Panel
- 9 Viewing the Connection Panel
- 11 Connections
- 12 Installing Batteries in the Remote Control
- 13 Viewing the Remote Control

Basic Operation

- 14 Placing Your Television in Standby Mode
- 14 Plug & Play Feature
- 15 Viewing the Display

Using the Menus

- 16 Viewing the Menus
- 16 Channel Menu
 - 16 Country
 - Auto Store
 - 17 Manual Store
 - Cable Search Option
 - 18 Now & Next Guide / Full Guide / Default Guide
 - 19 Channel List
 - 20 Channel Mode
 - Fine Tune
- 21 Picture Menu
 - 21 Mode
 - Backlight / Contrast / Brightness / Sharpness / Colour / Tint(G/R)
 - Advanced Settings
 - 22 Picture Options
 - 24 Picture Reset
 - Auto Adjustment
 - Screen

- 25 Sound Menu
 - 25 Mode
 - Equalizer
 - SRS TruSurround HD
 - Audio Language
 - Audio Format
 - Audio Description
 - Auto Volume
 - Speaker Select
 - 26 Sound Reset
- 27 Setup Menu
 - 27 Language
 - Time
 - 28 Game Mode
 - Child Lock
 - Change PIN
 - Parental Lock
 - Subtitle
 - 29 Teletext Language
 - Preference
 - Digital Text
 - Melody
 - 29 Energy Saving
 - Common Interface
- 30 Input Menu
 - 30 Source List
 - Edit Name
- 30 Support menu
 - 30 Self Diagnosis
 - 31 Software Upgrade

Anynet+

- 32 Connecting Anynet+ Devices
- 33 Setting Up Anynet+
- 33 Switching between Anynet+ Devices
- 35 Recording
- 35 Listening through a Receiver (Home Theatre)
- 36 Troubleshooting for Anynet+

Other Information

- 37 Teletext Feature
- 38 Using Your TV as a Computer (PC) Display
- 39 Troubleshooting: Before Contacting Service Personnel
- 40 Specifications
- Warning! Important Safety Instructions
- Wiring the Mains Power Supply Plug (UK Only)
- Warranty Card

Getting Started

Installing the Stand

Preset: Place the Guide Stand and Cover Neck onto the stand and fasten it using the screws. Applicable to 32inch models only.

- 1 Attach your LCD TV to the stand.
 - Two or more people should carry the TV.
 - Make sure to distinguish between the front and back of the stand when assembling them.
 - To make sure the TV is installed on the stand at a proper level, do not apply excess downward pressure to the upper left of right sides of the TV.
- 2 Fasten screws at position ❶ and then fasten screws at position ❷.
 - Stand the product up and fasten the screws. If you fasten the screws with the LCD TV placed down, it may lean to one side.
 - The stand is installed for models with the screen size of 37 inch and above.

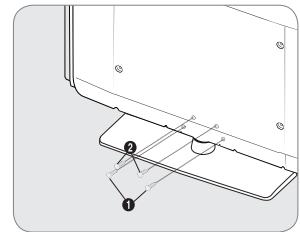
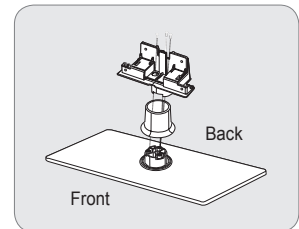

Installing the Wall Mount Kit

Wall mount items (sold separately) allow you to mount the TV on the wall. For detailed information on installing the wall mount, see the instructions provided with the Wall Mount items. Contact a technician for assistance when installing the wall mounted bracket. Samsung Electronics is not responsible for any damage to the product or injury to yourself or others if you elect to install the TV on your own.



- Do not install your Wall Mount Kit while your TV is turned on. It may result in personal injury due to electric shock.
- Remove the stand and cover the bottom hole with a cap and fasten with two screws.

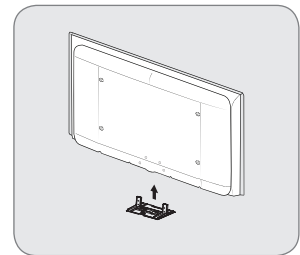

Anti-Theft Kensington Lock

The Kensington Lock is a device used to physically fix the system when using it in a public place. The appearance and locking method may differ from the illustration depending on the manufacturer. Refer to the manual provided with the Kensington Lock for proper use.

- The locking device has to be purchased separately.
- The location of the Kensington Lock may be different depending on its model.

- 1 Insert the locking device into the Kensington slot on the LCD TV (❶) and turn it in the locking direction (❷).
- 2 Connect the Kensington Lock cable (❸).
- 3 Fix the Kensington Lock to a desk or a heavy stationary object.

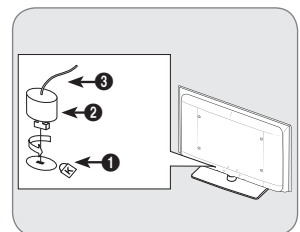

Securing the Installation Space

Keep the required distances between the product and other objects (e.g. walls) to ensure proper ventilation.

Failing to do so may result in fire or a problem with the product due to an increase in the internal temperature of the product.

Install the product so the required distances shown in the figure are kept.

- When using a stand or wall-mount, use parts provided by Samsung Electronics only.
 - If you use parts provided by another manufacturer, it may result in a problem with the product or an injury due to the product falling.
 - If you use parts provided by another manufacturer, it may result in a problem with the product or fire due to an increase in the internal temperature of the product due to poor ventilation.

■ When installing the product with a stand

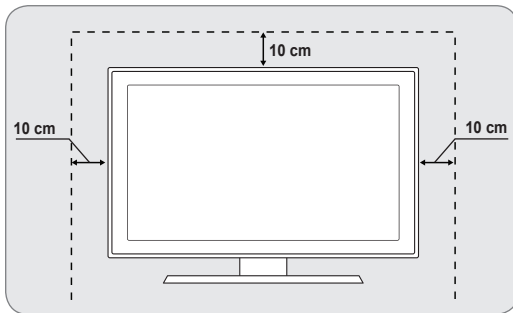

■ When installing the product with a wall-mount

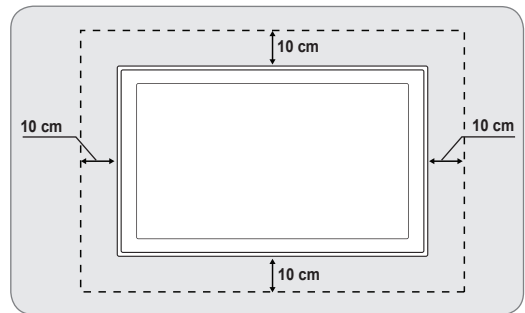

Securing the TV to the Wall



Caution: Pulling, pushing, or climbing on the TV may cause the TV to fall. In particular, ensure your children do not hang over or destabilize the TV; doing so may cause the TV to tip over, causing serious injuries or death. Follow all safety precautions provided on the included Safety Flyer. For added stability, install the anti-fall device for safety purposes, as follows.

To avoid the TV from falling:

- 1** Put the screws into the clamps and firmly fasten them onto the wall. Confirm that the screws have been firmly installed onto the wall.
 - You may need additional material such as an anchor depending on the type of wall.
 - Since the necessary clamps, screws, and string are not supplied, please purchase these additionally.
- 2** Remove the screws from the centre back of the TV, put the screws into the clamps, and then fasten the screws onto the TV again.
 - Screws may not be supplied with the product. In this case, please purchase the screws of the following specifications.
 - Screw Specifications:
 - For a 32 ~ 40 Inch LCD TV: M6 X 15
- 3** Connect the clamps fixed onto the TV and the clamps fixed onto the wall with a strong string and then tie the string tightly.
 - Install the TV near to the wall so that it does not fall backwards.
 - It is safe to connect the string so that the clamps fixed on the wall are equal to or lower than the clamps fixed on the TV.
 - Untie the string before moving the TV.
- 4** Verify all connections are properly secured. Periodically check connections for any sign of fatigue for failure. If you have any doubt about the security of your connections, contact a professional installer.

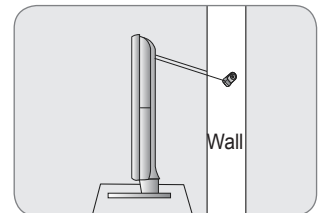
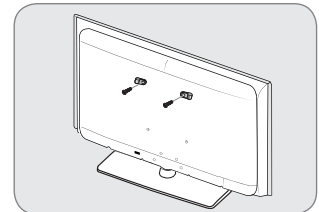
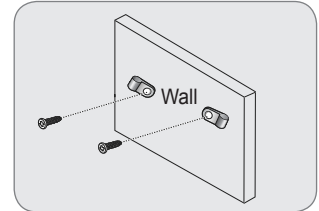

Accessories

- Please make sure the following items are included with your LCD TV. If any items are missing, contact your dealer.



Remote Control & Batteries
(AAA x 2)



Power Cords

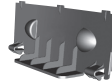

Cover-Bottom



Cleaning Cloth

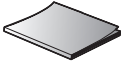

User Manual



(M4 X L16)

Stand Screw X 4

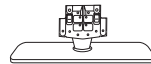

Stand



- The items colour and shape may vary depending on the model.
- Figures and illustrations in this User Manual are provided for reference only and may differ from actual product appearance. Product design and specifications may be changed without notice in order to enhance product performance.

Viewing the Control Panel

- The product colour and shape may vary depending on the model.
- You can use a button by pressing the side panel buttons.

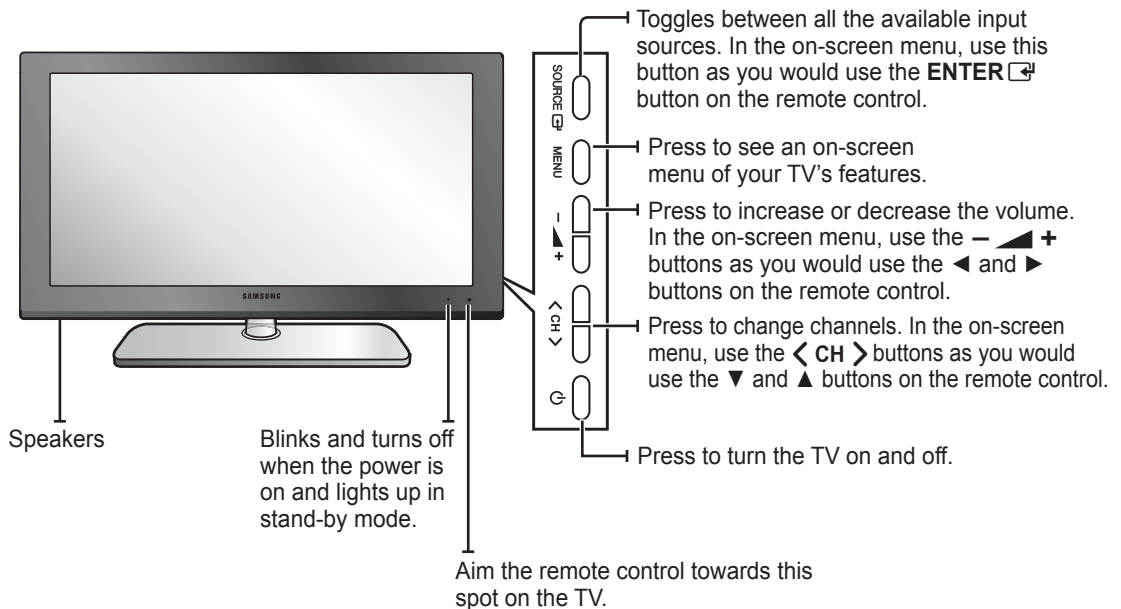

Viewing the Connection Panel

- The product colour and shape may vary depending on the model.

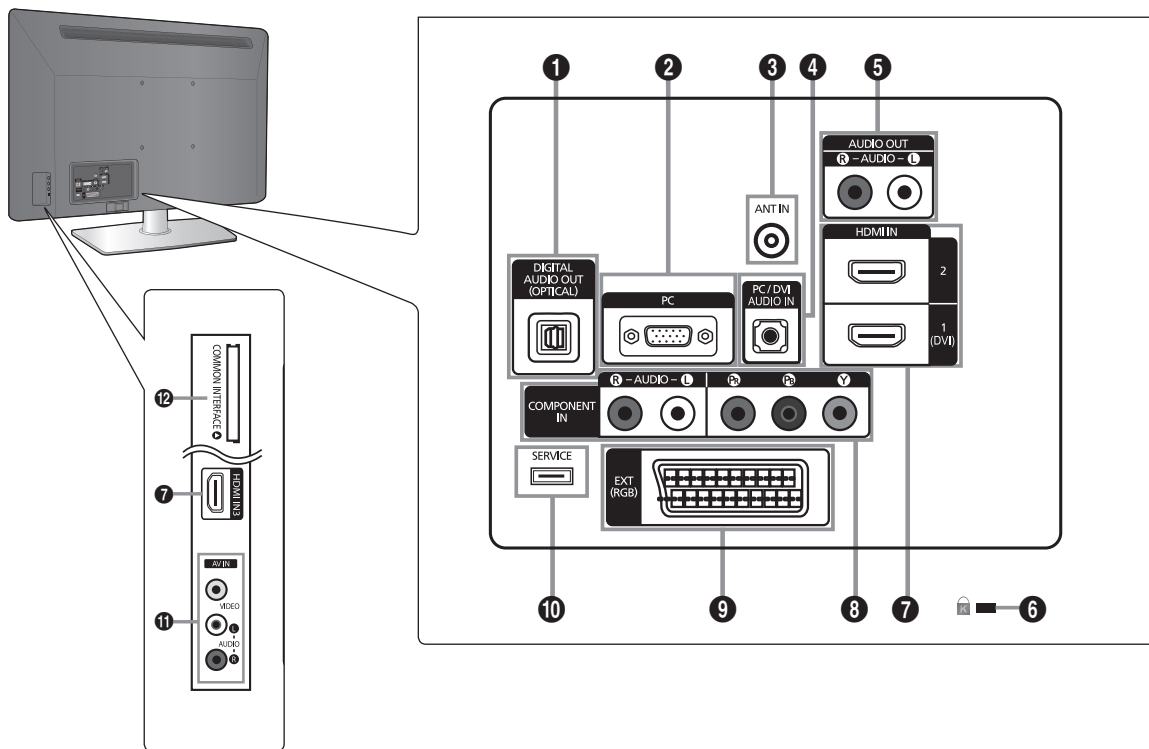

1 DIGITAL AUDIO OUT (OPTICAL)

Connects to a Digital Audio component such as a Home theatre receiver.

- When the HDMI IN jacks are connected, the **DIGITAL AUDIO OUT (OPTICAL)** jack on the TV outputs 2 channel audio only. If you want to hear 5.1 channel audio, connect the Optical jack on the DVD / Blu-ray player or Cable / Satellite Box directly to an Amplifier or Home Theatre, not the TV.

2 PC

Connect to the video output jack on your PC.

3 ANT IN

Connects to an antenna or cable TV system.

4 PC/DVI AUDIO IN

- Connect to the audio output jack on your PC.
- DVI audio outputs for external devices.

5 AUDIO OUT [R-AUDIO-L]

Connect RCA audio cables to **AUDIO OUT [R-AUDIO-L]** on the rear of your set and the other ends to corresponding audio in connectors on the Amplifier or DVD Home Theatre.

6 KENSINGTON LOCK (depending on the model)

The Kensington Lock (optional) is a device used to physically fix the system when used in a public place. If you want to use a locking device, contact the dealer where you purchased the TV.

- The location of the Kensington Lock may be different depending on its model.

7 HDMI IN 1(DVI), 2, 3

Connects to the HDMI jack of a device with an HDMI output.

- No sound connection is needed for an HDMI to HDMI connection.
- Use the **HDMI IN 1(DVI)** jack for DVI connection to an external device. Use a DVI to HDMI cable or DVI-HDMI adapter (DVI to HDMI) for video connection and the **PC/DVI AUDIO IN** jacks for audio. When using an HDMI / DVI cable connection, you must use the **HDMI IN 1(DVI)** jack.
- You can also use the ports to connect to a PC.

- What is HDMI?
'High Definition Multimedia interface' allows the transmission of high definition digital video data and multiple channels of digital audio.
The HDMI / DVI terminal supports DVI connection to an extended device with the appropriate cable (not supplied).
The difference between HDMI and DVI is that the HDMI device is smaller in size, has the HDCP (High Bandwidth Digital Copy Protection) coding feature installed, and supports multi - channel digital audio.
- The TV may not output sound and pictures may be displayed with abnormal colour when DVD / Blu-ray player / Cable Boxes / Satellite receivers supporting HDMI versions older than 1.3 are connected. When connecting an older HDMI cable and there is no sound, connect the HDMI cable to the **HDMI IN 1(DVI)** jack and the audio cables to the **PC/DVI AUDIO IN** jacks on the back of the TV. If this happens, contact the company that provided the DVD / Blu-ray player / Cable Box / Satellite receiver to confirm the HDMI version, then request a firmware update. HDMI cables that are not 1.3 may cause annoying flicker or no screen display.

8 COMPONENT IN

- Connect component video cables (optional) to component connector (P_R, P_B, Y) on the rear of your set and the other ends to corresponding component video out connectors on the DTV or DVD.
- If you wish to connect both the Set-Top Box and DTV (or DVD), you should connect the Set-Top Box to the DTV (or DVD) and connect the DTV (or DVD) to component connector (P_R, P_B, Y) on your set.
- The P_R, P_B and Y connectors on your component devices (DTV or DVD) are sometimes labelled Y, B-Y and R-Y or Y, Cb and Cr.
- Connect RCA audio cables (optional) to **[R-AUDIO-L]** on the rear of your set and the other ends to corresponding audio out connectors on the DTV or DVD.

9 EXT

Connector	Input			Output
	Video	Audio (L / R)	RGB	Video + Audio (L / R)
EXT	O	O	O	Only TV or DTV output is available.

- Inputs or outputs for external devices, such as VCR, DVD, video game device or video disc players.

10 SERVICE

Connector for software upgrades.

11 AV IN [VIDEO] / [R-AUDIO-L]

- Connect RCA cable to an appropriate external A/V device such as VCR, DVD or Camcorder.
- Connect RCA audio cables to **[R-AUDIO-L]** on your set and the other ends to corresponding audio out connectors on the A/V device.

12 COMMON INTERFACE Slot

- When not inserting 'CI CARD' in some channels, 'Scrambled Signal' is displayed on the screen.
- The pairing information containing a telephone number, CI CARD ID, Host ID and other information will be displayed in about 2~3 minutes. If an error message is displayed, please contact your service provider.
- When the channel information configuration has finished, the message 'Updating Completed' is displayed, indicating that the channel list is now updated.
 - You must obtain a CI CARD from a local cable service provider. Remove the CI CARD by carefully pulling it out with your hands since dropping the CI CARD may cause damage to it.
 - Insert the CI-Card in the direction marked on it.
 - The place of the **COMMON INTERFACE** Slot may be different depending on its model.
 - CAM is not supported in some countries and regions, check with your authorized dealer.

Connections

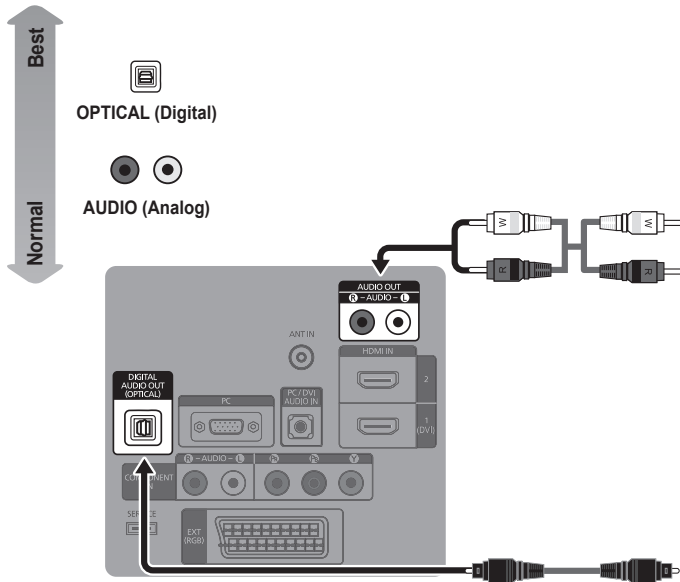

Analog Audio connection

Using a Audio Cable

Amplifier / DVD Home Theater



★ Digital Audio connection

Using an Optical Cable

Digital Audio System

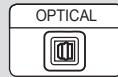

★ HD connection

Using an HDMI Cable



★ HD connection

Using an HDMI/DVI Cable

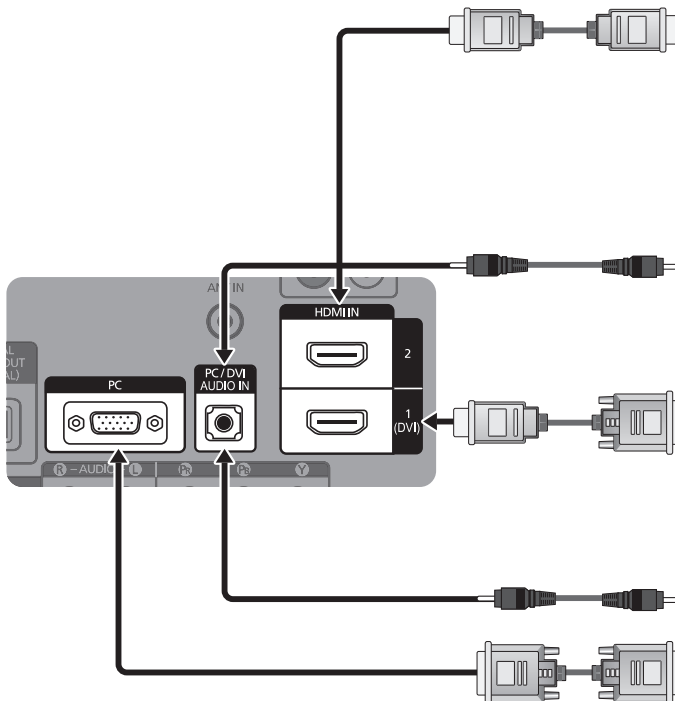

Using a D-Sub Cable

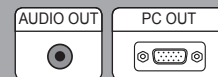

Installing Batteries in the Remote Control

- 1 Lift the cover at the back of the remote control upward as shown in the figure.
- 2 Install two AAA size batteries.
 - Make sure to match the '+' and '-' ends of the batteries with the diagram inside the compartment.
- 3 Replace the cover.
 - Remove the batteries and store them in a cool, dry place if you won't be using the remote control for a long time.
 - If the remote control doesn't work, check the following:
 - Is the TV power on?
 - Are the plus and minus ends of the batteries reversed?
 - Are the batteries drained?
 - Is there a power outage or is the power cord unplugged?
 - Is there a special fluorescent light or neon sign nearby?

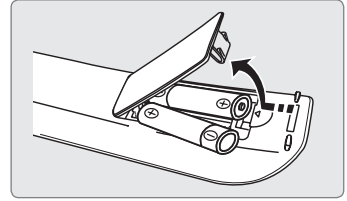

Viewing the Remote Control

- You can use the remote control up to a distance of about 23 feet from the TV.
- The performance of the remote control may be affected by bright light.
- The product colour and shape may vary depending on the model.

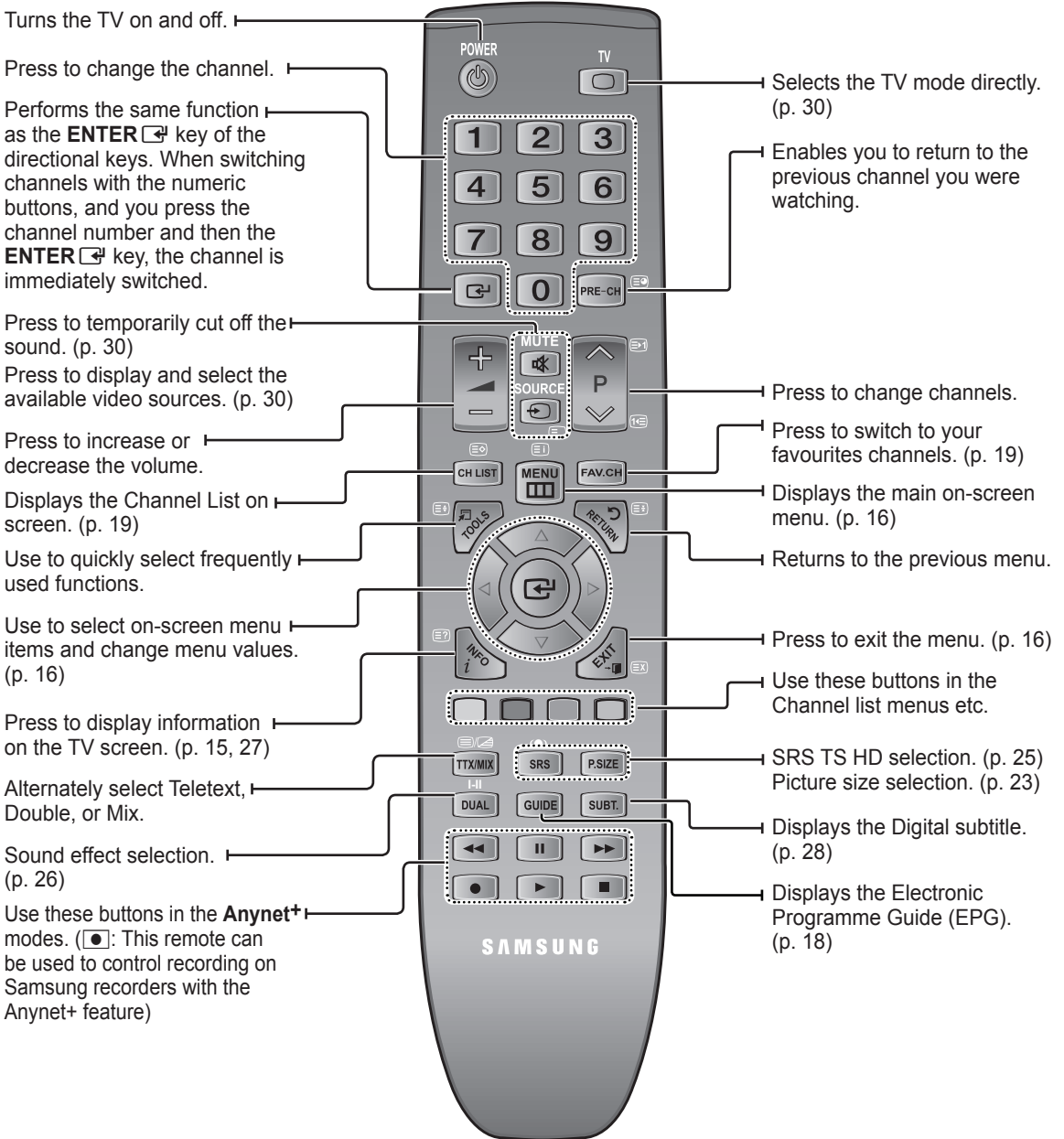



Teletext Functions (p. 37)

	Teletext mode selection (LIST / FLOF)		Teletext reveal		Teletext previous page
	Teletext store		Exit from the Teletext display		Teletext index
	Teletext size selection		Teletext sub page		Teletext hold
Colour buttons	Fastext topic selection		Teletext next page		Teletext cancel

Basic Operation













Placing Your Television in Standby Mode

Your set can be placed in standby mode in order to reduce the power consumption. The standby mode can be useful when you wish to interrupt viewing temporarily (during a meal, for example).

- 1 Press the **POWER**  button on the remote control.
 - The screen is turned off and a red standby indicator appears on your set.
- 2 To switch your set back on, simply press the **POWER**  button again.
 - Do not leave your set in standby mode for long periods of time (when you are away on holiday, for example). It is best to unplug the set from the mains and aerial.

Plug & Play Feature



When the TV is initially powered on, basic settings proceed automatically and subsequently.

- 1 Press the **POWER**  button.
 - You can also use the **POWER**  button on the TV.
 - The message **You can set the menu language.** is displayed.
- 2 Select the appropriate language by pressing the **▲** or **▼** button. Press the **ENTER**  button to confirm your choice.
- 3 Press the **◀** or **▶** button to select **Store Demo** or **Home Use**, then the **ENTER**  button.
 - We recommend setting the TV to **Home Use** mode for the best picture in your home environment.
 - **Store Demo** mode is only intended for use in retail environments.
 - If the unit is accidentally set to **Store Demo** mode and you want to return to **Home Use (Standard)**: Press the volume button on the TV. When the volume OSD is displayed, press and hold the **MENU** button on the TV for 5 seconds.
- 4 Press the **ENTER**  button. Select the appropriate country by pressing the **▲** or **▼** button. Press the **ENTER**  button to confirm your choice.
- 5 Press the **▲** or **▼** button to select **Air** or **Cable**, then press the **ENTER**  button.
 - **Air**: Air antenna signal.
 - **Cable**: Cable antenna signal.
- 6 Press the **▲** or **▼** button to select the channel source to memorize. Press the **ENTER**  button to select **Start**.
 - When setting the antenna source to **Cable**, a step appears allowing you to set a value for the digital channel search. For more information, refer to page 17.
 - **Digital & Analogue**: Digital and Analogue channels.
 - **Digital**: Digital channels.
 - **Analogue**: Analogue channels.
 - The channel search will start and end automatically.
 - Press the **ENTER**  button at any time to interrupt the memorization process.
 - After all the available channels are stored, the message **Set the Clock Mode.** is displayed.
- 7 Press the **ENTER**  button. Press the **▲** or **▼** button to select **Auto**, then press the **ENTER**  button.
 - If you select **Manual**, **Set current date and time** is displayed.
 - If you have received a digital signal, the time will be set automatically. If not, select **Manual** to set the clock. (Refer to page 27)
- 8 The connection method to provide the best quality HD is offered. After confirming the method, press the **ENTER**  button.
- 9 The message **Enjoy your TV.** is displayed. When you have finished, press the **ENTER**  button.



- Press the **ENTER**  button at any time to interrupt the memorization process.

If you want to reset this feature...

- 1 Press the **MENU** button.
Press the **▲** or **▼** button to select **Setup**, then press the **ENTER**  button.
- 2 Press the **ENTER**  button again to select **Plug & Play**.
- 3 Enter your 4 digit PIN number.
 - The default PIN number of a new TV set is '0-0-0-0'.
 - If you want to change PIN number, use the Change PIN function.



- The Plug & Play feature is only available in the TV mode.

Viewing the Display

The display identifies the current channel and the status of certain audio-video settings.

- 1 Press the **INFO** button on the remote control.
The TV will display the channel, the type of sound, and the status of certain picture and sound settings.
 - Press the **INFO** button once more or wait approximately 10 seconds and the display disappears automatically.



- Press the **INFO** button to viewing the information.

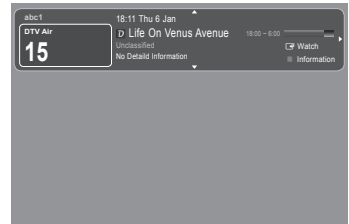

Using the Menus

Viewing the Menu

Menu provides one button access for controlling your TV. It enables you to perform a variety of tasks intuitively with a control panel on the screen rather than a variety of remote control button presses.

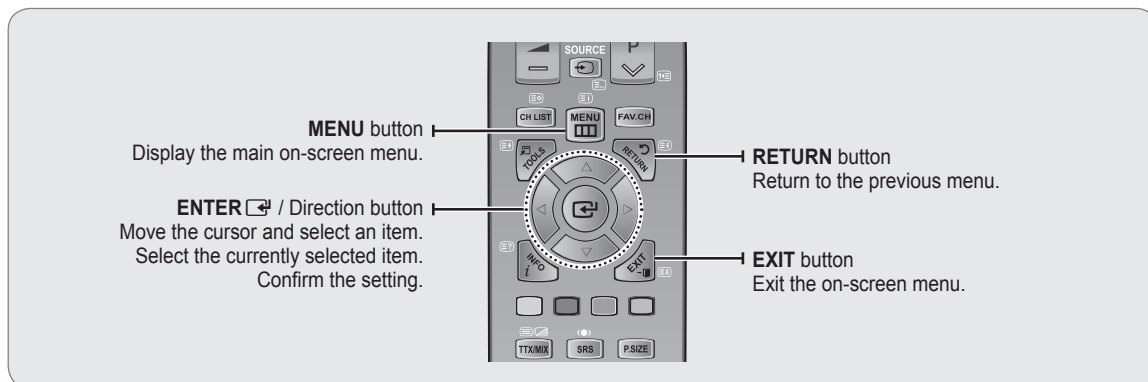

Operation the Menu

The access step may differ depending on the selected menu.

- 1 Press the **MENU** button.
 - The menu is displayed on the screen.
- 2 Press the **▲** or **▼** button to select one of the icons. Press the **ENTER** button to access the icon's sub-menu.
- 3 Press the **▲** or **▼** button to move to items in the menu. Press the **ENTER** button to enter items in the menu.
- 4 Press the **▲/▼/◀/▶** button to change the selected items. Press the **RETURN** button to return to the previous menu.
- 5 Press the **EXIT** button to exit from the menu.

Channel Menu

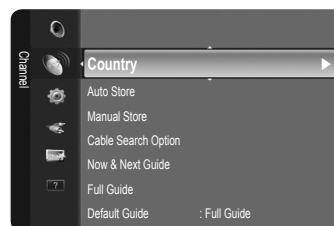

Channel	
Option	Description
Country	<p>The PIN number input screen appears. Enter your 4 digit PIN number.</p> <ul style="list-style-type: none"> <input type="checkbox"/> Analogue Channel You can change the country for analogue channels. <input type="checkbox"/> Digital Channel You can change the country for digital channels.
Auto Store	<p>You can scan for the frequency ranges available to you (and availability depends on your country). Automatically allocated programme numbers may not correspond to actual or desired programme numbers.</p> <p>Scans for all channels with active broadcast stations and stores them in the TV's memory.</p>



If a channel is locked using the **Child Lock** function, the PIN input window appears.

Channel	
Option	Description
Auto Store	<p><input type="checkbox"/> Air / Cable</p> <p>Antenna source to memorize</p> <ul style="list-style-type: none"> ■ Digital & Analogue: Digital and Analogue channels. ■ Digital: Digital channels. ■ Analogue: Analogue channels. <p>When selecting Cable → Digital & Analogue or Cable → Digital:</p> <p>Provide a value to scan for cable channels.</p> <ul style="list-style-type: none"> ■ Search Mode → Full / Network /Quick <ul style="list-style-type: none"> ■ Quick <ul style="list-style-type: none"> - Network ID: Displays the network identification code. - Frequency: Displays the frequency for the channel. - Modulation: Displays available modulation values. - Symbol Rate: Displays available symbol rates.
Manual Store	<p>Scans for a channel manually and stores it in the TV's memory.</p> <p><input type="checkbox"/> Digital Channel</p> <p>Manual store for digital channels.</p> <ul style="list-style-type: none"> ■ Channel: Set the Channel number using the ▲, ▼ or number (0~9) buttons. ■ Frequency: Set the frequency using the number buttons. ■ Bandwidth: Set the bandwidth using the ▲, ▼ or number (0~9) buttons. <p>When it has finished, channels are updated in the channel list.</p> <p><input type="checkbox"/> Analogue Channel</p> <p>Manual store for analogue channel.</p> <ul style="list-style-type: none"> ■ Programme (Programme number to be assigned to a channel): Sets the programme number using the ▲, ▼ or number (0~9) buttons. ■ Colour System → Auto / PAL / SECAM / NTSC4.43: Sets the colour system value using the ▲ or ▼ button. ■ Sound System → BG / DK / I / L: Sets the sound system value using the ▲ or ▼ button. ■ Channel (When you know the number of the channel to be stored): Press the ▲ or ▼ button to select C (Air channel) or S (Cable channel). Press the ► button, then press the ▲, ▼ or number (0~9) buttons to select the required number. <ul style="list-style-type: none"> - You can also select the channel number directly by pressing the number (0~9) buttons. - If there is abnormal sound or no sound, reselect the sound standard required. ■ Search (When you do not know the channel numbers): Press the ▲ or ▼ button to start the search. The tuner scans the frequency range until the first channel or the channel that you selected is received on the screen. ■ Store (When you store the channel and associated programme number): Set to OK by pressing the ENTER  button. <p>Cable Search Option (depending on the country)</p> <p>Using this function, you can manually add the channel range to be scanned by Full Search mode of the Auto Store function.</p> <ul style="list-style-type: none"> ■ Freq.Start (Frequency Start): Set the start frequency ■ Freq.Stop (Frequency Stop): Set the stop frequency ■ Modulation: Displays available modulation values. ■ Symbol Rate: Displays available symbol rates.



■ If you want to stop Auto Store, press the **ENTER**  button. The **Stop Auto Store?** message will be displayed. Select **Yes** by pressing the ◀ or ▶ button, then press the **ENTER**  button.



■ If a channel is locked using the **Child Lock** function, the PIN input window appears.

■ **Digital Channel** is only available in DTV mode.



■ **Analogue Channel** is only available in analogue TV mode.

■ **Channel mode**

- **P (Programme mode):** When completing tuning, the broadcasting stations in your area have been assigned to position numbers from P00 to P99. You can select a channel by entering the position number in this mode.
- **C (Air channel mode):** You can select a channel by entering the assigned number to each air broadcasting station in this mode.
- **S (Cable channel mode):** You can select a channel by entering the assigned number for each cable channel in this mode.

Channel	
Option	Description
Now & Next Guide / Full Guide / Default Guide	<p>The EPG (Electronic Programme Guide) information is provided by the broadcasters. Programme entries may appear blank or out of date as a result of the information broadcast on a given channel. The display will dynamically update as soon as new information becomes available.</p> <p><input type="checkbox"/> Now & Next Guide</p> <p>For the six channels indicated in the left-hand column, displays the Current programme and the Next programme information.</p> <p><input type="checkbox"/> Full Guide</p> <p>Displays the programme information as time ordered One hour segments. Two hours of programme information is displayed which may be scrolled forwards or backwards in time.</p> <p><input type="checkbox"/> Default Guide → Now & Next Guide / Full Guide</p> <p>You can decide whether to display either the Now & Next Guide or the Full Guide when the GUIDE button on the remote control is pressed.</p>



- You can also display the guide menu simply by pressing the **GUIDE** button. (To configure the **Default Guide**, refer to the descriptions.)

Full Guide

Full Guide	
DTV Cable 900 f tn	2:10 Tue 1 Jun
Freshmen On Campus	2:00 - 2:30
No Detailed Information	
Today	2:00 - 3:00 3:00 - 4:00
1 F tn	Freshmen O...
2 ITV Play	Mint Extra
3 Kerrang!	Loaded
4 Kiss	Fresh 40 with Dynamite MC
5 oneworld	The Distillery
6 Smash Hit!	Smash Hit! Sunday

Now & Next Guide





Now & Next Guide	
DTV Cable 900 f tn	2:10 Tue 1 Jun
Freshmen On Campus	2:00 - 2:30
No Detailed Information	
	Now Next
1 F tn	Street Hypn...
2 ITV Play	Mint Extra
3 Kerrang!	Loaded
4 Kiss	Fresh 40 with Dynamite MC
5 oneworld	The Distillery
6 Smash Hit!	Smash Hit! Sunday



(Red)

Using the Now & Next Guide / Full Guide

To...	Then...
Watch a programme in the EPG list	Select a programme by pressing the ▲, ▼, ◀, ▶ button.
Exit the guide	Press the Blue button
If the next programme is selected, it is scheduled with the clock icon displayed. If the ENTER button is pressed again, press the ◀, ▶ button to select Cancel Schedules , the scheduling is cancelled with the clock icon gone.	
View programme information	Select a programme of your choice by pressing the ▲, ▼, ◀, ▶ button. Then press the INFO button when the programme of your choice is highlighted. The programme title is on the upper part of the screen centre.
Please click on INFO button for the detailed information. Channel Number, Running Time, Status Bar, Parental Level, Video Quality Information (HD / SD), Sound Modes, Subtitle or Teletext, languages of Subtitle or Teletext and brief summary of the highlighted programme are included on the detailed information. "..." will be appeared if the summary is long.	
Toggle between the Using the Now & Next Guide / Full Guide	Press the Red button repeatedly.
In Full Guide Scrolls backwards quickly (24 hours). Scrolls forwards quickly (24 hours).	Press the Green button repeatedly. Press the Yellow button repeatedly.

Channel	
Option	Description
Channel List	<p>Using this menu, you can add / delete or set favourites channels and use the programme guide for digital broadcasts.</p> <p><input type="checkbox"/> All Channels Shows all currently available channels.</p> <p><input type="checkbox"/> Added Channels Shows all added channels.</p> <p><input type="checkbox"/> Favourites Shows all favourite channels. To select the Favourites channels you have set up, press the FAV.CH button on the remote control.</p> <p><input type="checkbox"/> Programmed Shows all current reserved programmes. Select a channel in the All Channels, Added Channels or Favourites screen by pressing the ▲ / ▼ buttons, and pressing the ENTER  button. Then you can watch the selected channel.</p> <p>Using the Colour buttons with the Channel List</p> <ul style="list-style-type: none"> ■ Red (Channel Type): Toggle between your TV, Radio, Data / Other and All. ■ Green (Zoom): Enlarges or shrinks a channel number. ■ Yellow (Select): Selects multiple channel lists. You can perform the add/delete or add to favourites/delete from favourites function for multiple channels at the same time. Select the required channels and press the Yellow button to set all the selected channels at the same time. The  mark appears to the left of the selected channels. <p>Channel List Option Menu (in All Channels / Added Channels / Favourites)</p> <ul style="list-style-type: none"> ■ Press the TOOLS button to use the option menu. ■ Option menu items may differ depending on the channel status. <p><input type="checkbox"/> Add / Delete You can delete or add a channel to display the channels you want.</p> <ul style="list-style-type: none"> ■ All deleted channels will be shown on All Channels menu. ■ You can also delete a channel to the Added Channels or Favourites menu in the same manner. <p><input type="checkbox"/> Add to Favourite / Delete from Favourite You can set channels you watch frequently as favourites.</p> <ul style="list-style-type: none"> ■ The  symbol will be displayed and the channel will be set as a favourite. ■ All favourite channels will be shown on Favourites menu. <p><input type="checkbox"/> Lock / Unlock You can lock a channel so that the channel cannot be selected and viewed.</p> <ul style="list-style-type: none"> ■ This function is available only when the Child Lock is set to On. (Refer to page 28) ■ The PIN number input screen appears. Enter your 4 digit PIN number. ■ The default PIN number of a new TV set is "0-0-0-0". You can change the PIN, by selecting Change PIN from the menu. ■ The  symbol will be displayed and the channel will be locked.





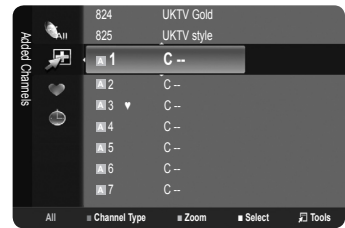



- You can select these options by simply pressing the **CH LIST** button on the remote control.



- **TOOLS (Tools):** Displays the **Delete** (or **Add**), **Add to Favourite** (or **Delete from Favourite**), **Lock** (or **Unlock**), **Timer Viewing**, **Edit Channel Name**, **Edit Channel Number**, **Sort**, **Select All** (or **Deselect All**) or **Auto Store** menu. (The Options menus may differ depending on the situation.)



Channel Status Display Icons

- : An Analogue channel.
- : A channel selected by pressing the Yellow button.
- : A channel set as a Favourite.
- : A programme currently being broadcast.
- : A locked channel.
- : A reserved programme

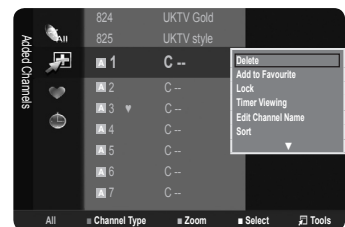

- A gray-coloured channel indicates the channel has been deleted.
- The **Add** menu only appears for deleted channels.



- Press the **TOOLS** button to display the **Tools** menu. You can also set the add to (or delete from) Favourite by selecting **Tools** → **Add to Favourite** (or **Delete from Favourite**).

Channel	
Option	Description
Channel List	<p><input type="checkbox"/> Timer Viewing</p> <p>If you reserve a programme you want to watch, the channel is automatically switched to the reserved channel in the Channel List; even when you are watching another channel. To reserve a programme, set the current time first. (Refer to page 27)</p> <ul style="list-style-type: none"> You can set the channel, day, month, year, hour and minute directly by pressing the number buttons on the remote control. Reserving a programme will be shown in the Programmed menu. Digital Programme Guide and Viewing Reservation: When a digital channel is selected, and you press the ► button, the Programme Guide for the channel appears. You can reserve a programme according to the procedures described above.
	<p><input type="checkbox"/> Edit Channel Name (analogue channels only)</p> <p>Channels can be labelled so that their call letters appear whenever the channel is selected.</p>
	<p><input type="checkbox"/> Edit Channel Number (digital channels only)</p> <p>You can also edit the channel number by pressing the number buttons on the remote control.</p>
	<p><input type="checkbox"/> Sort (analogue channels only)</p> <p>This operation allows you to change the programme numbers of the stored channels. This operation may be necessary after using the auto store.</p>
	<p><input type="checkbox"/> Select All / Deselect All</p> <ul style="list-style-type: none"> Select All: You can select all the channels in the channel list. Deselect All: You can deselect all the selected channels.
	<p><input type="checkbox"/> Auto Store</p> <p>For detailed procedures on setting up options, refer to pages 16-17.</p>
	<p>Channel List Option Menu (in Programmed))</p> <p>You can view, modify or delete a reservation. Press the TOOLS button to use the option menu.</p>
	<p><input type="checkbox"/> Change Info</p> <p>Select to change a viewing reservation.</p>
	<p><input type="checkbox"/> Cancel Schedules</p> <p>Select to cancel a viewing reservation.</p>
	<p><input type="checkbox"/> Information</p> <p>Select to view a viewing reservation. (You can also change the reservation information.)</p>
<p><input type="checkbox"/> Select All</p> <p>Select all reserved programmes.</p>	
Channel Mode	<p>When press the P ▼/▲ button, Channels will be switched within the selected channel list.</p> <ul style="list-style-type: none"> Added Ch.: Channels will be switched within the memorized channel list. Favourite Ch.: Channels will be switched within the favourite channel list.
Fine Tune	<p>If the reception is clear, you do not have to fine tune the channel, as this is done automatically during the search and store operation. If the signal is weak or distorted, you may have to fine tune the channel manually.</p> <ul style="list-style-type: none"> Fine tuned channels that have been saved are marked with an asterisk (*) on the right-hand side of the channel number in the channel banner. To reset the fine-tuning, select Reset by pressing the ▲ or ▼ button and then press the ENTER [↵] button.



- Only memorized channels can be reserved.



- The names of digital broadcasting channels are automatically assigned and cannot be renamed.



- You can only select **Deselect All** when there is a selected channel.



- Only Analogue TV channels can be fine tuned.

Picture Menu

Picture	
Option	Description
Mode	<p>Selects the type of picture settings that best correspond to your viewing preferences or requirements. Presets a higher brightness, contrast, and sharpness to the picture.</p> <ul style="list-style-type: none"> ■ Dynamic Recommended for use in bright room conditions. ■ Standard Recommended for use in a normal viewing condition. ■ Movie Corresponding to the conditions used in movie, recommended for use in darker viewing conditions.
Backlight / Contrast / Brightness / Sharpness / Colour / Tint(G/R)	<p>Your television has several setting options that allow you to control the picture quality.</p> <ul style="list-style-type: none"> ■ Backlight Adjusts the brightness of LCD back light. ■ Contrast Increases or decreases the brightness in white areas of the picture. Too little contrast and the picture may seem dark; too much contrast and the picture will lose details in white images. ■ Brightness Increases or decreases the overall brightness of the picture, but best used to adjust the black level of the image. Too little brightness and shadow detail will be lost; too much brightness and blacks will be gray and washed out. ■ Sharpness Increases or decreases the apparent detail in the picture. Too little sharpness and the image might look soft. Too much sharpness can add false edges to objects or can make noise more noticeable. ■ Colour Increases or decreases colour saturation levels in the picture. Too little colour and the image will be black and white (undersaturated); too much colour and the image will look oversaturated and cartoonish. ■ Tint(G/R) Changes the picture hue from reddish to a greenish appearance.
Advanced Settings	<p>Samsung's new TVs allow you to make even more precise picture settings than previous models.</p> <ul style="list-style-type: none"> ■ Black Tone → Off / Dark / Darker / Darkest Increases the picture's shadow detail by lightening the black level (ie changing the gamma) at low levels. This is most commonly used for watching movies with dark scenes to keep the picture from appearing washed out in bright rooms. ■ Dynamic Contrast → Off / Low / Medium / High Increases or decreases the difference between the brightest and darkest portions of the image with changing scenes. Shadows are more visible with dark scenes, while contrast is enhanced with bright scenes.

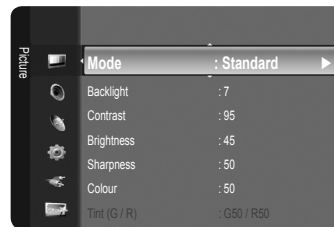

Press the **TOOLS** button to display the **Tools** menu. You can also set the picture mode by selecting **Tools** → **Picture Mode**.

Only analogue **TV, Ext., AV** modes of the PAL system, you cannot use the **Tint(G/R)** Function.

- When you make changes to **Backlight, Contrast, Brightness, Sharpness, Colour or Tint(G/R)**, the OSD will be adjusted accordingly.
- In PC mode, you can only make changes to **Backlight, Contrast and Brightness**.
- Settings can be adjusted and stored for each external device you have connected to an input of the TV.
- The energy consumed during use can be significantly reduced if the brightness level of the picture is lowered, which will reduce the overall running cost.

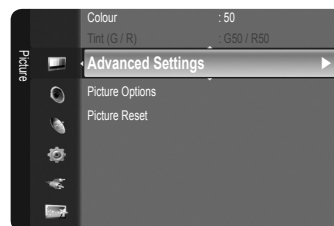

Advanced Settings is available in **Standard** or **Movie** mode.

- In PC mode, you can only make changes to **Gamma** and **White Balance** from among the **Advanced Settings** items.

Picture	
Option	Description
Advanced Settings	<ul style="list-style-type: none"> ■ Gamma Changes the rate at which images ramp or fade from light to dark. Recommended for advanced users only. ■ Colour Space Increases or decreases the visible colour range for red, green and blue. Recommended for advanced users only. <ul style="list-style-type: none"> – Auto: The TV will choose the colour range that is closest to the range used during TV and movie production. – Native: Displays the most enhanced, vibrant colours possible. ■ White Balance You can adjust the colour temperature for more natural picture colours. <ul style="list-style-type: none"> – R, G, B-Offset: Fine tunes the white balance, or colour 'temperature' in dark areas by changing the individual values of R, G, B. Recommended for advanced users only. – R, G, B-Gain: Fine tunes the white balance, or colour 'temperature' in the light areas by changing the individual values of R, G, B. Recommended for advanced users only. – Reset: The previously adjusted white balance will be reset to the factory defaults. ■ Flesh Tone Adjusts the colour of flesh tones. Increasing the value creates a more reddish picture. Decreasing the value creates a more greenish picture. ■ Edge Enhancement Increases or decreases the emphasis at object edges.
Picture Options	<ul style="list-style-type: none"> ■ Colour Tone Selects a preset white balance, or 'colour temperature' setting, to provide either a reddish or bluish hue, dependant upon your personal preference. <ul style="list-style-type: none"> – Cool: Selects a white balance, or colour 'temperature' with a bluish hue. Skin tones may have less warmth but whites will seem brighter. Recommended when watching normal TV broadcasting in a bright room. – Normal: Selects the white balance, or colour "temperature" with a less bluish, more reddish hue. Suitable for most viewing environments and programs. – Warm1, Warm2: Selects a redder, warmer hue that more closely matches the setting on monitors used in the production of TV and movie content. Recommended when watching movie and dramatic TV content. The lowest setting is best used for black & white content.



- Changing the adjustment value will refresh the adjusted screen.



- In PC mode, you can only make changes to the **Colour Tone** and **Size** from among the items in **Picture Options**.
- **Warm1** or **Warm2** is only activated when the picture mode is **Movie**.

	Picture
Option	Description
Picture Options	<ul style="list-style-type: none"> ■ Size Changes the screen shape in terms of height and width. Also known as Aspect Ratio. <ul style="list-style-type: none"> - Auto Wide: Enables the correct picture size to match the original video signal. - 16:9: Sets the picture aspect ratio to fill the screen. - Wide Zoom: Enlarges the middle part of the picture. - Zoom: Magnifies the picture contents horizontally and vertically. - 4:3: Sets the picture aspect ratio to 4:3 with black or gray side bars. - Screen Fit: Matches every pixel of the original image to a pixel on the TV screen (aka 1:1 pixel mapping) to show the entire image. <ul style="list-style-type: none"> ● Wide Zoom: Press the ► button to select Position, then press the ENTER button. Press the ▲ or ▼ button to move the picture up / down. Then press the ENTER button. ● Zoom: Press the ► button to Select Position, then press the ENTER button. Press the ▲ or ▼ button to move the picture up and down. Then press the ENTER button. Press the ► button to Select Size, then press the ENTER button. Press the ▲ or ▼ button to magnify or reduce the picture size in the vertical direction. Then press the ENTER button. ● After selecting Screen Fit in HDMI (1080i / 1080p) or Component (1080i / 1080p) mode: Select Position by pressing the ◀ or ▶ button. Use the ▲, ▼, ◀ or ▶ button to move the picture. Reset: Press the ◀ or ▶ button to select Reset, then press the ENTER button. You can initialize the setting. ● If you use the Screen Fit function with HDMI 720p input, 1 line will be cut at the top, bottom, left and right as in the Overscan function. ■ Screen Mode When setting the picture size to Auto Wide in a 16:9 wide TV, you can determine the picture size you want to see the 4:3 WSS (Wide Screen Service) image or nothing. Each individual European country requires different picture size so this function is intended for users to select it. <ul style="list-style-type: none"> - 16:9: Sets the picture to 16:9 wide mode. - Wide Zoom: Magnify the size of the picture more than 4:3. - Zoom: Magnify the size of the picture vertically on screen. - 4:3: Sets the picture to 4:3 normal mode. ■ Digital NR → Off / Low / Medium / High / Auto Can reduce the grain effect or level of video snow seen in images coming from poor quality sources. ■ HDMI Black Level → Normal / Low Adjusts the black level in the picture according to the type of signal being transmitted through HDMI. ■ Film Mode Applies the appropriate video processing needed to achieve the best picture quality for watching movies. <ul style="list-style-type: none"> - Off: Turn the Film Mode function off. - Auto: Improves the picture quality for fast motion scenes.



- You can select these options by simply pressing the **P.SIZE** button on the remote control.



- Depending on the input source, the picture size options may vary.
- The items available may differ depending on the selected mode.
- In PC Mode, only **16:9** and **4:3** mode can be adjusted.
- Settings can be adjusted and stored for each external device you have connected to an input of the TV.
- Temporary image retention may occur when viewing a static image on the set for more than two hours.



- This function is available in **Auto Wide** mode.
- This function is not available in **PC, Component** or **HDMI** mode.



- This function is active only when an external device is connected to the TV via **HDMI (RGB signals)**.



- **Film Mode** is supported in **TV, AV, COMPONENT (480i / 1080i)** and **HDMI (480i / 1080i)**.

Picture	
Option	Description
Picture Reset	Resets all picture settings to the default values. <ul style="list-style-type: none"> ■ Reset Picture Mode: Current picture values return to default settings.

Picture (In the PC mode)	
Option	Description
Auto Adjustment	Use the Auto Adjust function to have the TV set automatically adjust the video signals it receives. The function also automatically fine-tunes the settings and adjusts the frequency values and positions.
Screen	<ul style="list-style-type: none"> ■ Coarse / Fine The purpose of picture quality adjustment is to remove or reduce picture noise. If the noise is not removed by Fine-tuning alone, then adjust the frequency as best as possible (Coarse) and Fine-tune again. After the noise has been reduced, readjust the picture so that it is aligned on the centre of screen. ■ PC Position Adjust the PC's screen positioning if it does not fit the TV screen. Press the ▲ or ▼ button to adjusting the Vertical-Position. Press the ◀ or ▶ button to adjust the Horizontal-Position. ■ Image Reset You can replace all image settings with the factory default values.

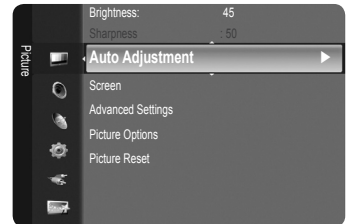

- Preset: Press the **SOURCE** button to select **PC** mode.



- This function does not work in DVI-HDMI mode.





- Press the **TOOLS** button to display the **Tools** menu. You can also set the Auto Adjustment by selecting **Tools** → **Auto Adjustment**.

Sound Menu

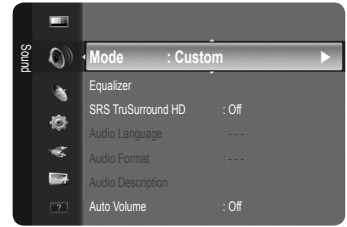
Sound	
Option	Description
Mode	<p>You can select a sound mode to suit your personal preferences.</p> <ul style="list-style-type: none"> ■ Standard: Selects the normal sound mode. ■ Music: Emphasizes music over voices. ■ Movie: Provides the best sound for movies. ■ Clear Voice: Emphasizes voice over other sounds. ■ Custom: Recalls your customized sound settings.
Equalizer	<p>The sound settings can be adjusted to suit your personal preferences.</p> <ul style="list-style-type: none"> ■ Mode: Selects the sound mode among the predefined settings. ■ Balance L/R: Adjusts the balance between the right and left speaker. ■ 100Hz / 300Hz / 1KHz / 3KHz / 10KHz (Bandwidth Adjustment): To adjust the level of different bandwidth frequencies. ■ Reset: Resets the equalizer settings to the default values.
SRS TruSurround HD	<p>SRS TruSurround HD is a patented SRS technology that solves the problem of playing 5.1 multichannel content over two speakers. TruSurround delivers a compelling, virtual surround sound experience through any two-speaker playback system, including internal television speakers. It is fully compatible with all multichannel formats.</p>
Audio Language (digital channels only)	<p>You can change the default value for audio languages. Displays the language information for the incoming stream.</p> <ul style="list-style-type: none"> ■ While viewing a digital channel, this function can be selected. ■ You can only select the language among the actual languages being broadcast.
Audio Format (digital channels only)	<p>When sound is emitted from both the main speaker and the audio receiver, a sound echo may occur due to the decoding speed difference between the main speaker and the audio receiver. In this case, use the TV Speaker function.</p> <ul style="list-style-type: none"> ■ While viewing a digital channel, this function can be selected. ■ The Audio Format appears according to the broadcasting signal.
Audio Description (digital channels only)	<p>This is an auxiliary audio function that provides an additional audio track for visually challenged persons. This function handles the Audio Stream for the AD (Audio Description), when it is sent along with the Main audio from the broadcaster. Users can turn the Audio Description On or Off and control the volume.</p> <ul style="list-style-type: none"> ■ Audio Description Turn the audio description function on or off. ■ Volume You can adjust the audio description volume. <ul style="list-style-type: none"> – Volume is active when Audio Description is set to On. ■ While viewing a Digital channel, this function can be selected.
Auto Volume	<p>Each broadcasting station has its own signal conditions, and so it is not easy to adjust the volume every time the channel is changed. This feature lets you automatically adjust the volume of the desired channel by lowering the sound output when the modulation signal is high or by raising the sound output when the modulation signal is low.</p>
Speaker Select	<p>When you watch TV with it connecting to a Home theatre, turn the TV speakers off so you can listen to sound from the Home theatre's (external) speakers.</p> <ul style="list-style-type: none"> ■ External Speaker: Used to listen to the sound of the External (Home Theatre) Speakers. ■ TV Speaker: Used to listen to the sound of the TV Speakers.



 Press the **TOOLS** button to display the **Tools** menu. You can also configure the sound mode by selecting **Tools** → **Sound Mode**.

 Press the **SRS** button on the remote control to select **Off** or **On**.

 The volume buttons and **MUTE** buttons do not operate when the **Speaker Select** is set to **External Speaker**.

■ If you select **External Speaker** in the **Speaker Select** menu, the sound settings will be limited.

Sound	
Option	Description
Sound Reset	You can restore the Sound settings to the factory defaults.

Selecting the Sound Mode

You can set the sound mode by pressing the **DUAL** button. When you press it, the current sound mode is displayed on the screen.

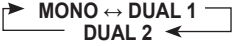
	Audio Type	Dual 1 / 2	Default
A2 Stereo	Mono	MONO	Automatic change
	Stereo	STEREO ↔ MONO	
	Dual	DUAL 1 ↔ DUAL 2	DUAL 1
NICAM Stereo	Mono	MONO	Automatic change
	Stereo	MONO ↔ STEREO	
	Dual	 MONO ↔ DUAL 1 DUAL 2 ←	DUAL 1

- If the stereo signal is weak and an automatic switching occurs, then switch to the mono.
- This function is only activated in stereo sound signal. It is deactivated in mono sound signal.
- This function is only available in TV mode.

Setup Menu

Setup	
Option	Description
Language	You can set the menu language.
Time	<p><input type="checkbox"/> Clock</p> <p>Setting the clock is necessary in order to use the various timer features of the TV. If you disconnect the power cord, you have to set the clock again.</p> <ul style="list-style-type: none"> ■ Clock Mode <p>You can set up the current time manually or automatically.</p> <ul style="list-style-type: none"> - Auto: Set the current time automatically using the time from the digital broadcast. - Manual: Set the current time to a manually specified time. ■ Clock Set <p>You can set the current time manually.</p> <ul style="list-style-type: none"> - This function is only available when Clock Mode is set to Manual. - You can set the day, month, year, hour and minute directly by pressing the number buttons on the remote control. <p><input type="checkbox"/> Sleep Timer</p> <p>The sleep timer automatically shuts off the TV after a preset time (30, 60, 90, 120, 150 and 180 minutes).</p> <ul style="list-style-type: none"> ■ The TV automatically switches to standby mode when the timer reaches 0. ■ To cancel the Sleep Timer function, select Off. <p><input type="checkbox"/> Timer 1 / Timer 2 / Timer 3</p> <p>Three different on / off timer settings can be made. You must set the clock first.</p> <ul style="list-style-type: none"> ■ On Time <p>Set the hour, minute, and activate / inactivate. (To activate timer with the setting you've chosen, set to Activate.)</p> ■ Off Time <p>Set the hour, minute, and activate / inactivate. (To activate timer with the setting you've chosen, set to Activate.)</p> ■ Volume <p>Set the desired volume level.</p> ■ Antenna <p>Select Air or Cable.</p> ■ Channel <p>Select the desired channel.</p> ■ Repeat <p>Select Once, Everyday, Mon~Fri, Mon~Sat, Sat~Sun or Manual.</p> <ul style="list-style-type: none"> - When Manual is selected, press the ► button to select the desired day of the week. Press the ENTER [↵] button over the desired day and the ✓ mark will appear.

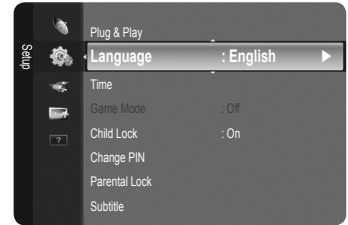



 ■ The current time will appear every time you press the **INFO** button.

 ■ Depending on the broadcast station and signal, the auto time may not be set correctly. If this occurs, set the time manually.

■ The Antenna or cable must be connected in order to set the time automatically.

 ■ Press the **TOOLS** button to display the **Tools** menu. You can also set the sleep timer by selecting **Tools** → **Sleep Timer**.

 ■ You can set the hour, minute and channel by pressing the number buttons on the remote control.

 ■ **Auto Power Off**

When you set the timer on, the television will eventually turn off, if no controls are operated for 3 hours after the TV was turned on by the timer. This function is only available in timer on mode and prevents overheating, which may occur if a TV is on for too long time.

Setup	
Option	Description
Game Mode	<p>When connecting to a game console such as PlayStation™ or Xbox™, you can enjoy a more realistic gaming experience by selecting game menu.</p> <ul style="list-style-type: none"> ■ If Game Mode is On: <ul style="list-style-type: none"> – Picture mode is automatically changed to Standard and cannot be changed. – Sound mode is automatically changed to Custom and cannot be changed. Adjust the sound using the equalizer.
Child Lock	<p>This feature allows you to prevent unauthorized users, such as children, from watching unsuitable programme by muting out video and audio.</p> <ul style="list-style-type: none"> ■ Before the setup screen appears, the PIN number input screen appears. Enter your 4 digit PIN number. ■ You can lock some channels in Channel List.
Change PIN	<p>You can change your personal ID number that is required to set up the TV.</p> <ul style="list-style-type: none"> ■ Before the setup screen appears, the PIN number input screen appears. Enter your 4 digit PIN number. ■ The default PIN number of a new TV set is 0-0-0-0.
Parental Lock	<p>This feature allows you to prevent unauthorized users, such as children, from watching unsuitable programme by a 4-digit PIN (Personal Identification Number) code that is defined by the user.</p> <ul style="list-style-type: none"> ■ The Parental Rating item differs depending on the country. ■ Before the setup screen appears, the PIN number input screen appears. Enter your 4 digit PIN number. ■ The default PIN number of a new TV set is "0-0-0-0". ■ You can change the PIN by selecting Change PIN from the menu. ■ When the parental ratings are set, the "🔒" symbol is displayed. ■ Allow All: Press to unlock all TV ratings. ■ Block All: Press to lock all TV ratings.
Subtitle	<p>You can activate and deactivate the subtitles. Use this menu to set the Subtitle Mode. Normal under the menu is the basic subtitle and Hard of hearing is the subtitle for a hearing-impaired person.</p> <ul style="list-style-type: none"> ■ Subtitle Switches subtitles on or off. ■ Mode Sets the subtitle mode. ■ Subtitle Language Set the subtitle language. <ul style="list-style-type: none"> – If the programme you are watching does not support the Hard of hearing function, Normal automatically activates even though Hard of hearing mode is selected. – English is the default in cases where the selected language is unavailable in the broadcast.



- To disconnect the game console and connect another external device, cancel game mode in the setup menu.
- If you display the TV menu in **Game Mode**, the screen shakes slightly.
- **Game Mode** is not available in regular **TV** and **PC** mode.



- **Child Lock** is available only in TV mode.
- The default PIN number of a new TV set is 0-0-0-0.



- If you forget the PIN code, press the remote control buttons in the following sequence, which resets the PIN to 0-0-0-0: **POWER** (Off) → **MUTE** → 8 → 2 → 4 → **POWER** (On).



- You can select these options simply by pressing the **SUBT.** button on the remote control.

Setup	
Option	Description
Teletext Language	<p>You can set the Teletext language by selecting the language type.</p> <ul style="list-style-type: none"> English is the default in cases where the selected language is unavailable in the broadcast.
Preference	<ul style="list-style-type: none"> Primary Audio Language / Secondary Audio Language / Primary Subtitle Language / Secondary Subtitle Language / Primary Teletext Language / Secondary Teletext Language Using this feature, users can select one of the languages. The language selected here is the default when the user selects a channel. If you change the language setting, the Subtitle Language, Audio Language, and the Teletext Language of the Language menu are automatically changed to the selected language. The Subtitle Language, Audio Language, and the Teletext Language of the Language menu show a list of languages supported by the current channel and the selection is highlighted. If you change this language setting, the new selection is only valid for the current channel. The changed setting does not change the setting of the Primary Subtitle Language, Primary Audio Language, or the Primary Teletext Language of the Preference menu.
Digital Text	<p>If the programme is broadcast with digital text, this feature is enabled.</p> <ul style="list-style-type: none"> MHEG (Multimedia and Hypermedia Information Coding Experts Group) An International standard for data encoding systems used in multimedia and hypermedia. This is at a higher level than the MPEG system which includes data-linking hypermedia such as still images, character service, animation, graphic and video files as well as multimedia data. MHEG is user runtime interaction technology and is being applied to various fields including VOD (Video-On-Demand), ITV (Interactive TV), EC (Electronic Commerce), tele-education, tele-conferencing, digital libraries and network games.
Melody	<p>A melody sound can be set to come on when the TV is powered On or Off.</p> <ul style="list-style-type: none"> The Melody does not play <ul style="list-style-type: none"> When no sound is output from the TV because the MUTE button has been pressed. When no sound is output from the TV because the volume has been reduced to minimum with the volume (-) button. When the TV is turned off by Sleep Timer function.
Energy Saving	<p>This feature adjusts the brightness of the TV in order to reduce power consumption. When watching TV at night, set the Energy Saving mode option to High to reduce eye fatigue as well as power consumption.</p>
Common Interface	<ul style="list-style-type: none"> CI Menu This enables the user to select from the CAM-provided menu. Select the CI Menu based on the menu PC Card. Application Info. This contains information on CAM inserted in the CI slot and displays it. The Application Info inserting is about the CI CARD. You can install the CAM anytime whether the TV is ON or OFF. <ol style="list-style-type: none"> Purchase the CI CAM module by visiting your nearest dealer or by phone. Insert the CI CARD into the CAM in the direction of the arrow until it fits. Insert the CAM with the CI CARD installed into the common interface slot. (Insert the CAM in the direction of the arrow, right up to the end so that it is parallel with the slot.) Check if you can see a picture on a scrambled signal channel.



- Press the **TOOLS** button to display the **Tools** menu. You can also set the Energy Saving option by selecting **Tools** → **Energy Saving**.



- CAM is not supported in some countries and regions, check with your authorized dealer.

Input Menu

Input	
Option	Description
Source List	<p>Use to select TV or other external input sources such as DVD / Blu-ray players / Cable Box / Satellite receivers (Set-Top Box) connected to the TV. Use to select the input source of your choice.</p> <ul style="list-style-type: none"> ■ TV / Ext. / AV / Component / PC / HDMI1/DVI / HDMI2 / HDMI3 <ul style="list-style-type: none"> – You can choose only those external devices that are connected to the TV. In the Source List, connected inputs will be highlighted and sorted to the top. Inputs that are not connected will be sorted to the bottom. – Using the Colour buttons on the remote with the Source list. <ul style="list-style-type: none"> ● Red (Refresh): Refreshes the connected external devices. ● TOOLS (Tools): Displays the Edit Name and Information menus.
Edit Name	<p>Name the device connected to the input jacks to make your input source selection easier.</p> <ul style="list-style-type: none"> ■ VCR / DVD / Cable STB / Satellite STB / PVR STB / AV Receiver / Game / Camcorder / PC / DVI / DVI PC / TV / IPTV / Blu-ray / HD DVD / DMA <ul style="list-style-type: none"> – When a PC with a resolution of 1920 x 1080@60Hz is connected to the HDMI IN 1(DVI) port, you should set the HDMI1/DVI mode to DVI PC in the Edit Name of the Input mode. – When connecting an HDMI/DVI cable to the HDMI IN 1(DVI) port, you should set the HDMI1/DVI mode to DVI or DVI PC in the Edit Name of the Input mode. In this case, a separate sound connection is required.

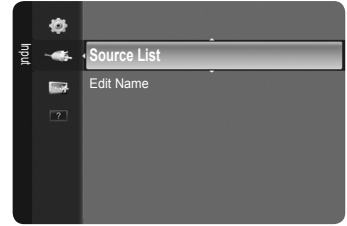

- Press the **SOURCE** button on the remote control to view an external signal source. TV mode can be selected by pressing the **TV** button.



- PC always stays activated

Support menu

Support	
Option	Description
Self Diagnosis	<ul style="list-style-type: none"> ■ Picture Test <p>If you think you have a picture problem, perform the picture test. Check the colour pattern on the screen to see if the problem still exists.</p> <ul style="list-style-type: none"> – Yes: If the test pattern does not appear or there is noise in the test pattern, select Yes. Therefore, contact Samsung's call centre for assistance. – No: If the test pattern is properly displayed, select No. There may be a problem with your external equipment. Please check your connections. If the problem still persists, refer to the external device's user manual. ■ Sound Test <p>If you think you have a sound problem, please perform the sound test. You can check the sound by playing a built-in melody sound through the TV.</p> <p>'Does the problem still exist with this sound test?' appears on the screen.</p> <ul style="list-style-type: none"> – Yes: If during the sound test you can hear sound only from one speaker or not at all, select Yes. Therefore, contact Samsung's call centre for assistance. – No: If you can hear sound from the speakers, select No. There may be a problem with your external equipment. Please check your connections. If the problem still persists, refer to the external device's user manual.

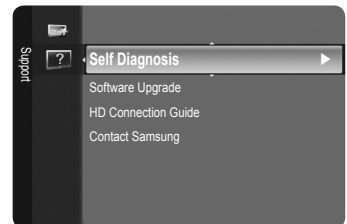

- If you hear no sound from the TV's speakers, before performing the sound test, make sure **Speaker Select** is set to TV speaker in the Sound menu.



- The melody will be heard during the test even if **Speaker Select** is set to **External Speaker** or the sound is muted by pressing the **MUTE** button.

Option	Description
Self Diagnosis	<ul style="list-style-type: none"> ■ Signal Information (digital channels only) Unlike analogue channels, which can vary in reception quality from 'snowy' to clear, digital (HDTV) channels have either perfect reception quality or you will not receive them at all. So, unlike analogue channels, you cannot fine tune a digital channel. You can, however, adjust your antenna to improve the reception of available digital channels.
Software Upgrade	<p>To keep your product up-to-date with new Digital Television features then software upgrades are periodically broadcast as part of the normal Television signal. It will automatically detect these signals and display the software upgrade banner. You are given the option to install the upgrade.</p> <ul style="list-style-type: none"> ■ By USB Insert a USB drive containing the firmware upgrade downloaded from samsung.com into the TV. Please be careful to not disconnect the power or remove the USB drive while upgrades are being applied. The TV will turn off and turn on automatically after completing the firmware upgrade. Please check the firmware version after the upgrades are complete (the new version will have a higher number than the older version). When software is upgraded, video and audio settings you have made will return to their default (factory) settings. We recommend you write down your settings so that you can easily reset them after the upgrade. ■ By Channel Upgrades the software using the broadcasting signal. ■ Standby Mode Upgrade To continue software upgrade with master power on, Select On by pressing the ▲ or ▼ button. 45 minutes after entering standby mode, a manual upgrade is automatically conducted. Since the power of the unit is turned on internally, the screen may be on slightly for the LCD product. This phenomenon may continue for more than 1 hour until the software upgrade is completed. ■ Alternative Software To display the software version information. <ul style="list-style-type: none"> □ HD Connection Guide This menu presents the connection method that provides the optimal quality for the HD TV. Refer to this information when connecting external devices to the TV. □ Contact Samsung View this information when your TV does not work properly or when you want to upgrade the software. You can view the information regarding the call centre, product and software file download method.



- If the signal strength meter indicates that the signal is weak, physically adjust your antenna to increase the signal strength. Continue to adjust the antenna until you find the best position with the strongest signal.

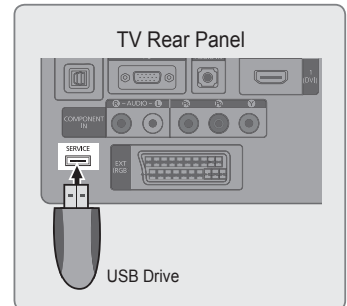

Connecting Anynet+ Devices

What is Anynet+?

Anynet+ is a function that enables you to control all connected Samsung devices that support Anynet+ with your Samsung TV's remote. The Anynet+ system can be used only with Samsung devices that have the Anynet+ feature. To be sure your Samsung device has this feature, check if there is an Anynet+ logo on it.

To connect to a TV

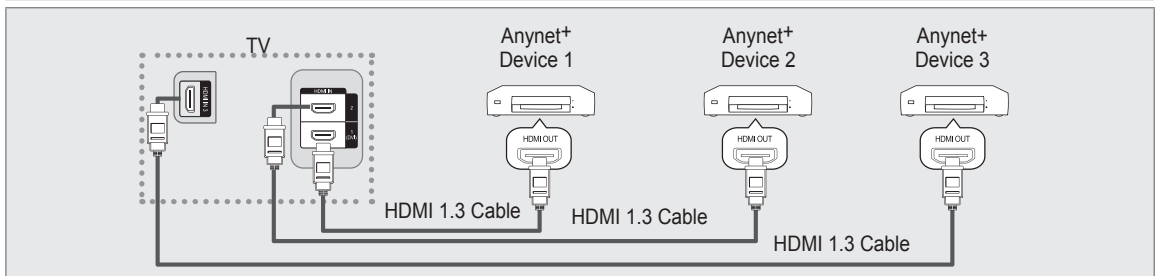

Connect the **HDMI IN (1(DVI), 2 or 3)** jack on the TV and the **HDMI OUT** jack of the corresponding Anynet+ device using an HDMI cable.

To connect to Home Theatre

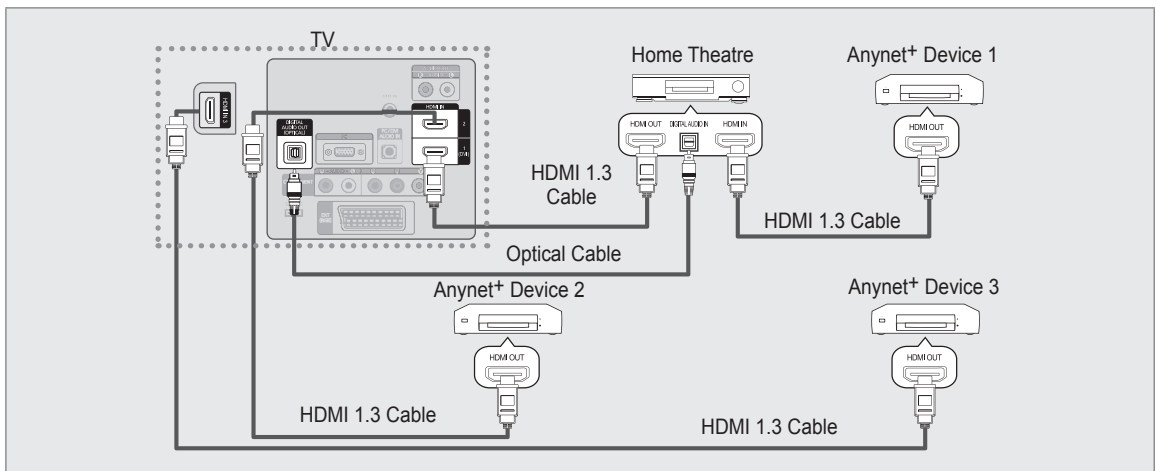

- 1 Connect the **HDMI IN (1(DVI), 2 or 3)** jack on the TV and the **HDMI OUT** jack of the corresponding Anynet+ device using an HDMI cable.
- 2 Connect the **HDMI IN** jack of the home theatre and the **HDMI OUT** jack of the corresponding Anynet+ device using an HDMI cable.
 - Connect the Optical cable between the **DIGITAL AUDIO OUT (OPTICAL)** jack on your TV and the Digital Audio Input on the Home Theatre.
 - When following the connection above, the Optical jack only outputs 2 channel audio. You will only hear sound from the Home Theatre's Front Left and Right speakers and the subwoofer. If you want to hear 5.1 channel audio, connect the **DIGITAL AUDIO OUT (OPTICAL)** jack on the DVD player or Cable / Satellite Box (ie Anynet Device 1 or 2) directly to the Amplifier or Home Theatre, not the TV.
 - Connect only one Home Theatre.
 - You can connect an Anynet+ device using the HDMI 1.3 cable. Some HDMI cables may not support Anynet+ functions.
 - Anynet+ works when the AV device supporting Anynet+ is in the Standby or On status.
 - Anynet+ supports up to 12 AV devices in total. Note that you can connect up to 3 devices of the same type.

Setting Up Anynet+

Option	Description
Setup	<ul style="list-style-type: none"> ■ Anynet+ (HDMI-CEC) To use the Anynet+ Function, Anynet+ (HDMI-CEC) must be set to On. When the Anynet+ (HDMI-CEC) function is disabled, all the Anynet+ related operations are deactivated. ■ Auto Turn Off Setting an Anynet+ Device to turn Off automatically when the TV is turned Off. <ul style="list-style-type: none"> – The active source on the TV remote must be set to TV to use the Anynet+ function. – If you set Auto Turn Off to Yes, connected external devices are also turned off when the TV is turned off. If an external device is still recording, it may or may not turn off.

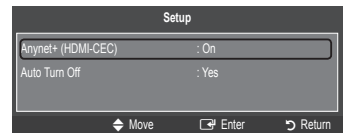
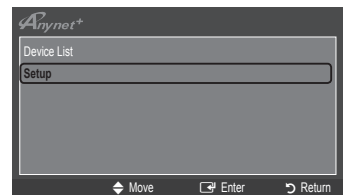
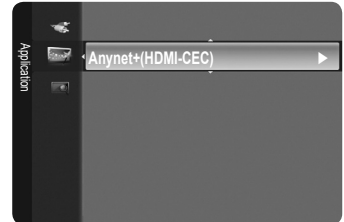

Switching between Anynet+ Devices

- 1 Press the **TOOLS** button. Press the **ENTER** button to select **Anynet+ (HDMI-CEC)**.
- 2 Press the **▲** or **▼** button to select **Device List**, then press the **ENTER** button.
 - Anynet+ devices connected to the TV are listed. If you cannot find a device you want, press the red button to scan for devices.
- 3 Press the **▲** or **▼** button to select to a particular device and press the **ENTER** button. It is switched to the selected device.
 - Switching to the selected devices may take up to 2 minutes. You cannot cancel the operation during the switching operation.
 - The time required to scan for devices is determined by the number of connected devices.
 - When the device scan is complete, the number of devices found are not displayed.
 - Although the TV automatically searches the device list when the TV is turned on via the power button, devices connected to the TV may not always be automatically displayed in the device list. Press the Red button to search for the connected device.
 - If you have selected external input mode by pressing the **SOURCE** button, you cannot use the Anynet+ function. Make sure to switch to an Anynet+ device by using the **Device List**.

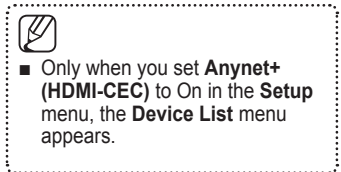
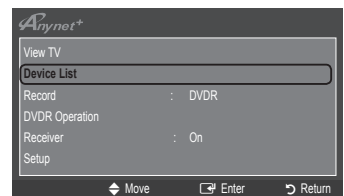

Anynet+ Menu

The Anynet+ menu changes depending on the type and status of the Anynet+ devices connected to the TV.

Option	Description
View TV	Anynet+ mode changes to TV broadcast mode.
Device List	Shows the Anynet+ device list.
(device_name) MENU	Shows the connected device menus. E.g. If a DVD recorder is connected, the disc menu of the DVD recorder will appear.
(device_name) Operation	Shows the play menu of the connected device. E.g. If a DVD recorder is connected, the play menu of the DVD recorder will appear.
Recording: (*recorder)	Starts recording immediately using the recorder. (This is only available for devices that support the recording function.)
Stop Recording: (*recorder)	Stops recording.
Receiver	Sound is played through the receiver.



- If more than one recording device is connected, they are displayed as (*recorder) and if only one recording device is connected, it will be represented as (*device_name).





TV Remote Control Buttons Available in Anynet+ Mode

Device Type	Operating Status	Available Buttons
Anynet+ Device	After switching to the device, when the menu of the corresponding device is displayed on the screen.	Numeric buttons ▲/▼/◀/▶/ ENTER buttons Colour buttons EXIT button
	After switching to the device, while playing a file	(Backward search) (Forward search) (Stop) / (Play) (Pause)
Device with built-in Tuner	After switching to the device, when you are watching a TV programme	P / P button
Audio Device	When Receiver is activated	- + / MUTE button

- The Anynet+ function only works when the active source on the TV remote control is set to TV.
- The button works only while in the recordable state.
- You cannot control Anynet+ devices using the buttons on the TV. You can control Anynet+ devices only using the TV remote control.
- The TV remote control may not work under certain conditions. If this occurs, reselect the Anynet+ device.
- The Anynet+ functions do not operate with other manufacturers' products.
- The , operations may differ depending on the device.

Recording

You can make a recording of a TV programme using a Samsung recorder.

- 1 Press the **TOOLS** button. Press the **ENTER**  button to select **Anynet+ (HDMI-CEC)**.
- 2 Press the **▲** or **▼** button to select **Recording Immediately** and press the **ENTER**  button. Recording begins.
 - **When there is more than one recording device.**
When multiple recording devices are connected, the recording devices are listed. Press the **▲** or **▼** button to select a recording device and press the **ENTER**  button. Recording begins.
 - **When the recording device is not displayed.**
Select **Device List** and press the Red button to search devices
- 3 Press the **EXIT** button to exit.
 - You can record the source streams by selecting **Record:** (device_name).
 - Pressing the  button will record whatever you are currently watching. If you are watching video from another device, the video from the device is recorded.
 - Before recording, check whether the antenna jack is properly connected to the recording device. To properly connect an antenna to a recording device, refer to the recording device's users manual.

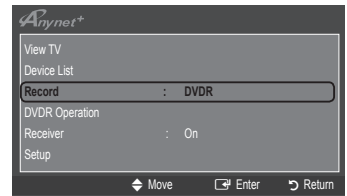

Listening through a Receiver (Home Theatre)

You can listen to sound through a receiver instead of the TV speaker.

- 1 Press the **TOOLS** button. Press the **ENTER**  button to select **Anynet+ (HDMI-CEC)**.
- 2 Press the **▲** or **▼** button to select **Receiver**. Press the **◀** or **▶** button to select **On** or **Off**.
- 3 Press the **EXIT** button to exit.
 - If your receiver supports audio only, it may not appear in the device list.
 - The receiver will work when you have properly connected the optical in jack of the receiver to the **DIGITAL AUDIO OUT (OPTICAL)** jack of the TV.
 - When the receiver (home theatre) is set to On, you can hear sound output from the TV's Optical jack. When the TV is displaying a DTV(air) signal, the TV will send out 5.1 channel sound to the Home theatre receiver. When the source is a digital component such as a DVD and is connected to the TV via HDMI, only 2 channel sound will be heard from the Home Theatre receiver.
 - If there is a power interruption to the TV when the **Receiver** is set to **On** (by disconnecting the power cord or a power failure), the **Speaker Select** may be set to **External Speaker** when you turn the TV on again. (Refer to page 25)

Troubleshooting for Anynet+

Problem	Possible Solution
Anynet+ does not work.	<ul style="list-style-type: none"> ● Check if the device is an Anynet+ device. The Anynet+ system supports Anynet+ devices only. ● Connect only one receiver (home theatre). ● Check if the Anynet+ device power cord is properly connected. ● Check the Anynet+ device's Video/Audio/HDMI 1.3 cable connections. ● Check whether Anynet+ (HDMI-CEC) is set to On in the Anynet+ setup menu. ● Check whether the TV remote control is in TV mode. ● Check whether it is Anynet+ exclusive remote control. ● Anynet+ doesn't work in certain situations. (Searching channels, Operating Plug & Play, etc.) ● When connecting or removing the HDMI 1.3 cable, please make sure to search devices again or turn your TV off and on again. ● Check if the Anynet+ Function of Anynet+ device is set on.
I want to start Anynet+.	<ul style="list-style-type: none"> ● Check if the Anynet+ device is properly connected to the TV and check if the Anynet+ (HDMI-CEC) is set to On in the Anynet+ Setup menu. ● Press the TV button on the TV remote control to switch to TV. Then press the TOOLS button to show the Anynet+ menu and select a menu you want.
I want to exit Anynet+.	<ul style="list-style-type: none"> ● Select View TV in the Anynet+ menu. ● Press the SOURCE button on the TV remote control and select a device other than Anynet+ devices. ● Press P ∇/\wedge to change the TV mode. (Note that the channel button operates only when a tuner-embedded Anynet+ device is not connected.)
The message 'Connecting to Anynet+ device...' appears on the screen.	<ul style="list-style-type: none"> ● You cannot use the remote control when you are configuring Anynet+ or switching to a view mode. ● Use the remote control when the Anynet+ setting or switching to view mode is complete.
The Anynet+ device does not play.	<ul style="list-style-type: none"> ● You cannot use the play function when Plug & Play is in progress.
The connected device is not displayed.	<ul style="list-style-type: none"> ● Check whether or not the device supports Anynet+ functions. ● Check whether or not the HDMI 1.3 cable is properly connected. ● Check whether Anynet+ (HDMI-CEC) is set to On in the Anynet+ setup menu. ● Search Anynet+ devices again. ● You can connect an Anynet+ device using the HDMI 1.3 cable only. Some HDMI cables may not support Anynet+ functions. ● If it is terminated by an abnormal situation such as disconnecting the HDMI cable or power cord or a power failure, please repeat the device scan.
The TV programme cannot be recorded.	<ul style="list-style-type: none"> ● Check whether the antenna jack on the recording device is properly connected.
The TV sound is not output through the receiver.	<ul style="list-style-type: none"> ● Connect the optical cable between TV and the receiver.

Teletext Feature

Most television stations provide written information services via Teletext. The index page of the Teletext service gives you information on how to use the service. In addition, you can select various options to suit your requirements by using the remote control buttons.

■ For Teletext information to be displayed correctly, channel reception must be stable. Otherwise, information may be missing or some pages may not be displayed.

- 1 (mode)
Press to select the Teletext mode (LIST/FLOF). If you press it in the LIST mode, it switches into the List save mode. In the List save mode, you can save Teletext page into list using the (store) button.
- 2 (store)
Used to store the Teletext pages.
- 3 (size)
Press to display the double-size letters in the upper half of the screen. For lower half of the screen, press it again. To display normal screen, press it once again.
- 4 (reveal)
Used to display the hidden text (answers to quiz games, for example). To display normal screen, press it again.
- 5 **Colour buttons (red/green/yellow/blue)**
If the FASTEXT system is used by a broadcasting company, the different topics covered on a Teletext page are colour-coded and can be selected by pressing the coloured buttons. Press one of them corresponding to the required. The page is displayed with other coloured information that can be selected in the same way. To display the previous or next page, press the corresponding coloured button.
- 6 (Teletext on/mix)
Press to activate Teletext mode after selecting the channel providing the Teletext service. Press it twice to overlap the Teletext with the current broadcasting screen.
- 7 (exit)
Exit from the Teletext display.
- 8 (sub-page)
Used to display the available sub-page.
- 9 (page up)
Used to display the next Teletext page.
- 10 (page down)
Used to display the previous Teletext page.
- 11 (index)
Used to display the index (contents) page at any time while you are viewing Teletext.
- 12 (hold)
Used to hold the display on a given page if the selected page is linked with several secondary pages which follow on automatically. To resume, press it again.
- 13 (cancel)
Used to display the broadcast when searching for a page.

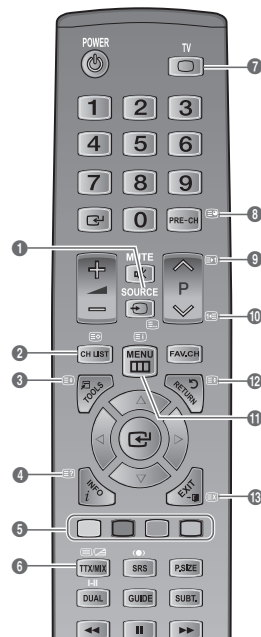

■ You can change Teletext pages by pressing the numeric buttons on the remote control.

The Teletext pages are organized according to six categories:

Part	Contents
A	Selected page number.
B	Broadcasting channel identity.
C	Current page number or search indications.
D	Date and time.
E	Text.
F	Status information. FASTEXT information.

- Teletext information is often divided between several pages displayed in sequence, which can be accessed by:
 - Entering the page number
 - Selecting a title in a list
 - Selecting a coloured heading (FASTEXT system)
- Teletext level supported by the TV is version 2.5 which is capable of displaying additional graphics or text.
- Depending upon the transmission, blank side panels can occur when displaying Teletext.
- In these cases, additional graphics or text is not transmitted.
- Older TV's which do not support version 2.5 are not capable of displaying any additional graphics or text, regardless of the Teletext transmission.
- Teletext 16:9, picture is 16:9

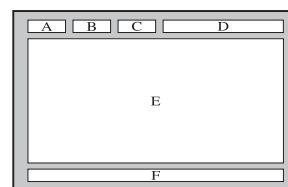

■ Press the TV button to exit from the Teletext display.

Using Your TV as a Computer (PC) Display

Setting Up Your PC Software (Based on Windows XP)

The Windows display-settings for a typical computer are shown below. The actual screens on your PC will probably be different, depending upon your particular version of Windows and your particular video card. However, even if your actual screens look different, the same basic set-up information will apply in almost all cases. (If not, contact your computer manufacturer or Samsung Dealer.)

- 1 First, click on 'Control Panel' on the Windows start menu.
- 2 When the control panel window appears, click on 'Appearance and Themes' and a display dialog-box will appear.
- 3 When the control panel window appears, click on 'Display' and a display dialogbox will appear.
- 4 Navigate to the 'Settings' tab on the display dialog-box.
 - The correct size setting (resolution) - Optimum: 1920 X 1080 pixels.
 - If a vertical-frequency option exists on your display settings dialog box, the correct value is '60' or '60 Hz'. Otherwise, just click 'OK' and exit the dialog box.

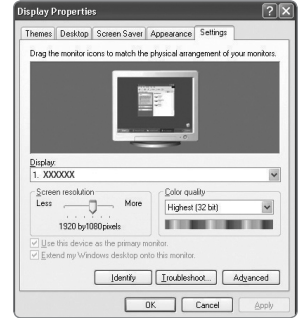

Display Modes

If the signal from the system equals the standard signal mode, the screen is adjusted automatically. If the signal from the system doesn't equal the standard signal mode, adjust the mode by referring to your videocard user guide; otherwise there may be no video. For the display modes listed on the next page, the screen image has been optimized during manufacturing.

D-Sub and HDMI/DVI Input

Mode	Resolution	Horizontal Frequency (KHz)	Vertical Frequency (Hz)	Pixel Clock Frequency (MHz)	Sync Polarity (H / V)
IBM	640 x 350	31.469	70.086	25.175	+/-
	720 x 400	31.469	70.087	28.322	-/-
MAC	640 x 480	35.000	66.667	30.240	-/-
	832 x 624	49.726	74.551	57.284	-/-
	1152 x 870	68.681	75.062	100.000	-/-
VESA CVT	720 x 576	35.910	59.950	32.750	-/+
	1152 x 864	53.783	59.959	81.750	-/+
	1280 x 720	44.772	59.855	74.500	-/+
	1280 x 720	56.456	74.777	95.750	-/+
	1280 x 960	75.231	74.857	130.000	-/+
VESA DMT	640 x 480	31.469	59.940	25.175	-/-
	640 x 480	37.861	72.809	31.500	-/-
	640 x 480	37.500	75.000	31.500	-/-
	800 x 600	37.879	60.317	40.000	+/+
	800 x 600	48.077	72.188	50.000	+/+
	800 x 600	46.875	75.000	49.500	+/+
	1024 x 768	48.363	60.004	65.000	-/-
	1024 x 768	56.476	70.069	75.000	-/-
	1024 x 768	60.023	75.029	78.750	+/+
	1152 x 864	67.500	75.000	108.000	+/+
	1280 x 1024	63.981	60.020	108.000	+/+
	1280 x 1024	79.976	75.025	135.000	+/+
	1280 x 800	49.702	59.810	83.500	-/+
	1280 x 800	62.795	74.934	106.500	-/+
	1280 x 960	60.000	60.000	108.000	+/+
	1360 x 768	47.712	60.015	85.500	+/+
	1440 x 900	55.935	59.887	106.500	-/+
1440 x 900	70.635	74.984	136.750	-/+	
1680 x 1050	65.290	59.954	146.250	-/+	
VESA GTF	1280 x 720	52.500	70.000	89.040	-/+
	1280 x 1024	74.620	70.000	128.943	-/-
VESA DMT / DTV CEA	1920 x 1080p	67.500	60.000	148.500	+/+

- When using an HDMI / DVI cable connection, you must use the **HDMI IN 1(DVI)** jack.
- The interlace mode is not supported.
- The set might operate abnormally if a non-standard video format is selected.
- Separate and Composite modes are supported. SOG is not supported.
- Too long or low quality VGA cable can cause picture noise at high resolution modes (1920x1080 or 1600x1200).

Troubleshooting: Before Contacting Service Personnel

No sound or picture	<ul style="list-style-type: none"> • Check that the mains lead has been connected to a wall socket. • Check that you have pressed the button on your set. • Check the picture contrast and brightness settings. • Check the volume.
Normal picture but no sound	<ul style="list-style-type: none"> • Check the volume. • Check whether the MUTE button has been pressed on the remote control. • Check the Speaker Select settings.
Screen is black and power indicator light blinks steadily	<ul style="list-style-type: none"> • On your computer check; Power, Signal Cable. • The TV is using its power management system. • Move the computer's mouse or press any key on the keyboard.
No picture or black and white picture	<ul style="list-style-type: none"> • Adjust the colour settings. • Check that the broadcast system selected is correct.
Sound and picture interference	<ul style="list-style-type: none"> • Try to identify the electrical appliance that is affecting the set and move it further away. • Plug your set into a different mains socket.
Blurred or snowy picture, distorted sound	<ul style="list-style-type: none"> • Check the direction, location and connections of your aerial. • This interference is often due to the use of an indoor aerial.
Remote control malfunctions	<ul style="list-style-type: none"> • Replace the remote control batteries. • Clean the upper edge of the remote control (transmission window). • Check the battery terminals.
'Check signal cable.' message is displayed	<ul style="list-style-type: none"> • Check that the signal cable is firmly connected to the PC or video sources. • Check that the PC or video sources are turned on.
On PC mode, 'Not Supported Mode.' message is displayed	<ul style="list-style-type: none"> • Check the maximum resolution and the frequency of the video adaptor. • Compare these values with the data in the Display Modes.
The damaged picture appears in the corner of the screen	<ul style="list-style-type: none"> • If Screen Fit is selected in some external devices, the damaged picture may appear in the corner of the screen. This symptom is caused by external devices, not TV.
The 'Resets all settings to the default values.' message appears.	<ul style="list-style-type: none"> • This appears when you press and hold the EXIT button for a while. The product settings are reset to the factory defaults.
You may see small particles if you look closely at the edge of the bezel surrounding the TV screen.	<ul style="list-style-type: none"> • This is part of the product's design and is not a defect.

- This TFT LCD panel uses a panel consisting of sub pixels (6 220 800) which require sophisticated technology to produce. However, there may be few bright or dark pixels on the screen. These pixels will have no impact on the performance of the product.



Specifications

Model Name	LE32B530, LE32B541	LE37B530	LE40B530, LE40B541	LE46B530
Screen Size (Diagonal)	32 inches	37 inches	40 inches	46 inches
Power Consumption Standby	<1W	<1W	<1W	<1W
PC Resolution (Optimum)	1920 x 1080 @ 60 Hz	1920 x 1080 @ 60 Hz	1920 x 1080 @ 60 Hz	1920 x 1080 @ 60 Hz
Sound (Output)	10W x 2	10W x 2	10W x 2	10W x 2
Dimensions (WxDxH) Body With stand	801 X 77 X 518 mm 801 X 220 X 562 mm	918 X 77 X 597 mm 918 X 300 X 650 mm	998 X 78 X 621 mm 998 X 260 X 686 mm	1127 X 78 X 712 mm 1127 X 260 X 766 mm
Weight With Stand	12 kg	15 kg	18 kg	24 kg
Environmental Considerations Operating Temperature Operating Humidity Storage Temperature Storage Humidity	10°C to 40°C (50°F to 104°F) 10% to 80%, non-condensing -20°C to 45°C (-4°F to 113°F) 5% to 95%, non-condensing			
Stand Swivel Left / Right	-20° ~ 20°			

- Design and specifications are subject to change without prior notice.
- This device is a Class B digital apparatus.
- For the power supply and Power Consumption, refer to the label attached to the product.

Warning! Important Safety Instructions

Please read the appropriate section that corresponds to the marking on your Samsung product before attempting to install the product.

CAUTION	 This symbol indicates that high voltage is present inside. It is dangerous to make any kind of contact with any internal part of this product.
RISK OF ELECTRIC SHOCK DO NOT OPEN	
CAUTION: TO REDUCE THE RISK OF ELECTRIC SHOCK, DO NOT REMOVE COVER (OR BACK). THERE ARE NO USER SERVICEABLE PARTS INSIDE. REFER ALL SERVICING TO QUALIFIED PERSONNEL.	 This symbol alerts you that important literature concerning operation and maintenance has been included with this product.

- The slots and openings in the cabinet and in the back or bottom are provided for necessary ventilation. To ensure reliable operation of this apparatus, and to protect it from overheating, these slots and openings must never be blocked or covered.
 - Do not cover the slots and openings with a cloth or other materials.
 - Do not block the slots and openings by placing this apparatus on a bed, sofa, rug or other similar surface.
 - Do not place this apparatus in a confined space, such as a bookcase, or built-in cabinet, unless proper ventilation is provided. Give your product 10 cm (4 inch) clearance from the wall.
- Do not place this apparatus near or over a radiator or heat resistor, or where it is exposed to direct sunlight.
- Do not place heat generating items such as candles, ashtrays, incense, flammable gas or explosive materials near the product.
- Do not place a water containing vessel on this apparatus, as this can result in a risk of fire or electric shock.
- Do not expose this apparatus to rain or place it near water (near a bathtub, washbowl, kitchen sink, or laundry tub, in a wet basement, or near a swimming pool etc.). If this apparatus accidentally gets wet, unplug it and contact an authorized dealer immediately. Make sure to pull out the power cord from the outlet before cleaning.
- This apparatus use batteries. In your community there might be regulations that require you to dispose of these batteries properly under environmental considerations. Please contact your local authorities for disposal or recycling information.
- Do not overload wall outlets, extension cords or adaptors beyond their capacity, since this can result in fire or electric shock.
- Power-supply cords should be routed so that they are not likely to be walked on or pinched by items placed upon or against them, paying particular attention to cords at plug end, adaptors and the point where they exit from the appliance.
- To protect this apparatus from a lightning storm, or when it is left unattended and unused for long periods of time, unplug it from the wall outlet and disconnect the antenna or cable system. This will prevent damage to the set due to lightning and power line surges.
- Before connecting the AC power cord to the DC adaptor outlet, make sure the voltage designation of the DC adaptor corresponds to the local electrical supply.
- Never insert anything metallic into the open parts of this apparatus. Doing so may create a danger of electric shock.
- To avoid electric shock, never touch the inside of this apparatus. Only a qualified technician should open this apparatus.
- Make sure to plug the power cord in until it is firmly inserted. When removing the power cord, make sure to hold the power plug when pulling the plug from the outlet. Do not touch the power cord with wet hands.
- If this apparatus does not operate normally - in particular, if there are any unusual sounds or smells coming from it unplug it immediately and contact an authorized dealer or service centre.
- Be sure to pull the power plug out of the outlet if the TV is to remain unused or if you are to leave the house for an extended period of time (especially when children, elderly or disabled people will be left alone in the house).
Accumulated dust can cause an electric shock, an electric leakage or a fire by causing the power cord to generate sparks and heat or the insulation to deteriorate.
- Be sure to contact an authorized service centre, when installing your set in a location with heavy dust, high or low temperatures, high humidity, chemical substances and where it operates for 24 hours such as the airport, the train station etc. Failure to do so may cause serious damage to your set.
- Use only a properly grounded plug and receptacle.
An improper ground may cause electric shock or equipment damage. (Class I Equipment only.)
- To disconnect the apparatus from the mains, the plug must be pulled out from the mains socket, therefore the mains plug shall be readily operable.
- Do not allow children to hang onto the product.
- Store the accessories (battery, etc.) in a location safely out of the reach of children.
- Do not install the product in an unstable location such as a shaky shelf, a slanted floor or a location exposed to vibration.
- Do not drop or impart any shock to the product. If the product is damaged, disconnect the power cord and contact a service centre.



**WARNING - TO PREVENT THE SPREAD OF FIRE,
KEEP CANDLES OR OTHER OPEN FLAMES
AWAY FROM THIS PRODUCT AT ALL TIMES.**

Wiring the Mains Power Supply Plug (UK Only)

IMPORTANT NOTICE

The mains lead on this equipment is supplied with a moulded plug incorporating a fuse. The value of the fuse is indicated on the pin face of the plug and, if it requires replacing, a fuse approved to BSI1362 of the same rating must be used. Never use the plug with the fuse cover omitted if the cover is detachable. If a replacement fuse cover is required, it must be of the same colour as the pin face of the plug. Replacement covers are available from your dealer.

If the fitted plug is not suitable for the power points in your house or the cable is not long enough to reach a power point, you should obtain a suitably approved extension lead or consult your dealer for assistance. However, if there is no alternative but to cut off the plug, remove the fuse and then safely dispose of the plug.

Do NOT connect the plug to a mains socket as there is a risk of shock hazard from the bared flexible cord.

IMPORTANT

The wires in the mains lead are coloured in accordance with the following code:

BLUE - NEUTRAL BROWN - LIVE

As these colours may not correspond to the coloured markings identifying the terminals in your plug, proceed as follows :

The wire coloured BLUE must be connected to the terminal marked with the letter N or coloured BLUE or BLACK. The wire coloured BROWN must be connected to the terminal marked with the letter L or coloured BROWN or RED.

WARNING:

DO NOT CONNECT EITHER WIRE TO THE EARTH TERMINAL, WHICH IS MARKED WITH THE LETTER E OR BY THE EARTH SYMBOL , OR COLOURED GREEN OR GREEN AND YELLOW.

Warranty Card



UNITED KINGDOM

This Samsung product is warranted for a period of twelve (12) months from the original date of purchase, against defective materials and workmanship. In the event that warranty service is required, you should return the product to the retailer from whom it was purchased. However, Samsung Authorised Dealers and Authorised Service Centres in other EC Countries will comply with the warranty on the terms issued to purchasers in the country concerned. In case of difficulty, details of our Authorised Service Centres are available from:

Samsung Electronics U.K. Ltd.
Customer Care Centre
PO Box 17243
Edinburgh, EH11 4YB
United Kingdom
Tel: 0845 SAMSUNG (7267864) (UK & Northern Ireland)
Tel: 0818 717 100 (EIRE Only)
Fax: +44 0845 650 8080
Web : www.samsung.com

WARRANTY CONDITIONS

1. The warranty is only valid if, when warranty service is required, the warranty card is fully and properly completed and is presented with the original invoice or sales slip or confirmation, and the serial number on the product has not been defaced.
2. Samsung's obligations are limited to the repair or, at its discretion, replacement of the product or the defective part.
3. Warranty repairs must be carried out by Authorised Samsung Dealers or Authorised Service Centres. No re-imbusement will be made for repairs carried out by non Samsung Dealers and, any such repair work and damage to the products caused by such repair work will not be covered by this warranty.
4. This product is not considered to be defective in materials nor workmanship by reason that it requires adaptation in order to conform to national or local technical or safety standards in force in any Country other than the one for which the product was originally designed and manufactured.



Correct Disposal of This Product (Waste Electrical & Electronic Equipment)

(Applicable in the European Union and other European countries with separate collection systems) This marking on the product, accessories or literature indicates that the product and its electronic accessories (e.g. charger, headset, USB cable) should not be disposed of with other household waste at the end of their working life. To prevent possible harm to the environment or human health from uncontrolled waste disposal, please separate these items from other types of waste and recycle them responsibly to promote the sustainable reuse of material resources. Household users should contact either the retailer where they purchased this product, or their local government office, for details of where and how they can take these items for environmentally safe recycling. Business users should contact their supplier and check the terms and conditions of the purchase contract. This product and its electronic accessories should not be mixed with other commercial wastes for disposal.

[English]



Les bons gestes de mise au rebut de ce produit (Déchets d'équipements électriques et électroniques)

(Applicable dans les pays de l'Union Européenne et dans d'autres pays européens pratiquant le tri sélectif)

Ce symbole sur le produit, ses accessoires ou sa documentation indique que ni le produit, ni ses accessoires électroniques usagés (chargeur, casque audio, câble USB, etc.) ne peuvent être jetés avec les autres déchets ménagers. La mise au rebut incontrôlée des déchets présentant des risques environnementaux et de santé publique, veuillez séparer vos produits et accessoires usagés des autres déchets. Vous favoriserez ainsi le recyclage de la matière qui les compose dans le cadre d'un développement durable. Les particuliers sont invités à contacter le magasin leur ayant vendu le produit ou à se renseigner auprès des autorités locales pour connaître les procédures et les points de collecte de ces produits en vue de leur recyclage. Les entreprises et professionnels sont invités à contacter leurs fournisseurs et à consulter les conditions de leur contrat de vente. Ce produit et ses accessoires ne peuvent être jetés avec les autres déchets professionnels et commerciaux.

[Français]



Korrekte Entsorgung von Altgeräten (Elektroschrott)

(In den Ländern der Europäischen Union und anderen europäischen Ländern mit einem separaten Sammelsystem)

Die Kennzeichnung auf dem Produkt, Zubehörteilen bzw. auf der dazugehörigen Dokumentation gibt an, dass das Produkt und Zubehörteile (z. B. Ladegerät, Kopfhörer, USB-Kabel) nach ihrer Lebensdauer nicht zusammen mit dem normalen Haushaltsmüll entsorgt werden dürfen. Entsorgen Sie dieses Gerät und Zubehörteile bitte getrennt von anderen Abfällen, um der Umwelt bzw. der menschlichen Gesundheit nicht durch unkontrollierte Müllbeseitigung zu schaden. Helfen Sie mit, das Altgerät und Zubehörteile fachgerecht zu entsorgen, um die nachhaltige Wiederverwertung von stofflichen Ressourcen zu fördern. Private Nutzer wenden sich an den Händler, bei dem das Produkt gekauft wurde, oder kontaktieren die zuständigen Behörden, um in Erfahrung zu bringen, wo Sie das Altgerät bzw. Zubehörteile für eine umweltfreundliche Entsorgung abgeben können. Gewerbliche Nutzer wenden sich an ihren Lieferanten und gehen nach den Bedingungen des Verkaufsvertrags vor. Dieses Produkt und elektronische Zubehörteile dürfen nicht zusammen mit anderem Gewerbemüll entsorgt werden.

[Deutsch]



Correcte verwijdering van dit product (elektrische & elektronische afvalapparatuur)

Dit merkteken op het product, de accessoires of het informatiemateriaal duidt erop dat het product en zijn elektronische accessoires (bv. lader, headset, USB-kabel) niet met ander huishoudelijk afval verwijderd mogen worden aan het einde van hun gebruiksduur. Om mogelijke schade aan het milieu of de menselijke gezondheid door ongecontroleerde afvalverwijdering te voorkomen, moet u deze artikelen van andere soorten afval scheiden en op een verantwoorde manier recyclen, zodat het duurzame hergebruik van materiaalbronnen wordt bevorderd. Huishoudelijke gebruikers moeten contact opnemen met de winkel waar ze dit product hebben gekocht of met de gemeente waar ze wonen om te vernemen waar en hoe ze deze artikelen milieuvriendelijk kunnen laten recyclen. Zakelijke gebruikers moeten contact opnemen met hun leverancier en de algemene voorwaarden van de koopovereenkomst nalezen. Dit product en zijn elektronische accessoires mogen niet met ander bedrijfsafval voor verwijdering worden gemengd.

[Nederlands]



Corretto smaltimento del prodotto (rifiuti elettrici ed elettronici)

(Applicabile nell'Unione Europea e in altri paesi europei con sistema di raccolta differenziata)

Il marchio riportato sul prodotto, sugli accessori o sulla documentazione indica che il prodotto e i relativi accessori elettronici (quali caricabatterie, cuffia e cavo USB) non devono essere smaltiti con altri rifiuti domestici al termine del ciclo di vita. Per evitare eventuali danni all'ambiente o alla salute causati dall'inopportuno smaltimento dei rifiuti, si invita l'utente a separare il prodotto e i suddetti accessori da altri tipi di rifiuti e a riciclarli in maniera responsabile per favorire il riutilizzo sostenibile delle risorse materiali. Gli utenti domestici sono invitati a contattare il rivenditore presso il quale è stato acquistato il prodotto o l'ufficio locale preposto per tutte le informazioni relative alla raccolta differenziata e al riciclaggio per questo tipo di materiali. Gli utenti aziendali sono invitati a contattare il proprio fornitore e verificare i termini e le condizioni del contratto di acquisto. Questo prodotto e i relativi accessori elettronici non devono essere smaltiti unitamente ad altri rifiuti commerciali.

[Italiano]



Eliminación correcta de este producto (Residuos de aparatos eléctricos y electrónicos)

(Aplicable en la Unión Europea y en países europeos con sistemas de recogida selectiva de residuos)

La presencia de este símbolo en el producto, accesorios o material informativo que lo acompañan, indica que al finalizar su vida útil ni el producto ni sus accesorios electrónicos (como el cargador, cascos, cable USB) deberán eliminarse junto con otros residuos domésticos. Para evitar los posibles daños al medio ambiente o a la salud humana que representa la eliminación incontrolada de residuos, separe estos productos de otros tipos de residuos y recícelos correctamente. De esta forma se promueve la reutilización sostenible de recursos materiales. Los usuarios particulares pueden contactar con el establecimiento donde adquirieron el producto o con las autoridades locales pertinentes para informarse sobre cómo y dónde pueden llevarlo para que sea sometido a un reciclaje ecológico y seguro. Los usuarios comerciales pueden contactar con su proveedor y consultar las condiciones del contrato de compra. Este producto y sus accesorios electrónicos no deben eliminarse junto a otros residuos comerciales.

[Español]



Eliminação Correcta Deste Produto (Resíduos de Equipamentos Elétricos e Eletrônicos)

Esta marca apresentada no produto, nos acessórios ou na literatura – indica que o produto e os seus acessórios eletrónicos (por exemplo, o carregador, o auricular, o cabo USB) não deverão ser eliminados juntamente com os resíduos domésticos no final do seu período de vida útil. Para impedir danos ao ambiente ou à saúde humana causados pela eliminação incontrolada de resíduos, deverá separar estes equipamentos de outros tipos de resíduos e reciclá-los de forma responsável, para promover uma reutilização sustentável dos recursos materiais. Os utilizadores domésticos deverão contactar o estabelecimento onde adquiriram este produto ou as entidades oficiais locais para obterem informações sobre onde e de que forma podem entregar estes equipamentos para permitir efectuar uma reciclagem segura em termos ambientais. Os utilizadores profissionais deverão contactar o seu fornecedor e consultar os termos e condições do contrato de compra. Este produto e os seus acessórios eletrónicos não deverão ser misturados com outros resíduos comerciais para eliminação.

[Português]



Korrekt avfallshandtering av produkten (elektriska och elektroniska produkter)

Denna markering på produkten, tillbehören och i manualen anger att produkten och de elektroniska tillbehören (t.ex. laddare, headset, USB-kabel) inte bör sorteras tillsammans med annat hushållsavfall när de kasseras. Till förebyggande av skada på miljö och hälsa bör dessa föremål hanteras separat för ändamålsenlig återvinning av beståndsdelarna. Hushållsanvändare bör kontakta den återförsäljare som sålt produkten eller sin kommun för vidare information om var och hur produkten och tillbehören kan återvinnas på ett miljösäkert sätt. Företagsanvändare bör kontakta leverantören samt verifiera angivna villkor i köpekontraktet. Produkten och de elektroniska tillbehören bör inte hanteras tillsammans med annat kommersiellt avfall.

[Svenska]



Korrekt affaldsbortskaffelse af dette produkt (elektrisk & elektronisk udstyr)

Mærket på dette produkt, på tilbehør eller i den medfølgende dokumentation betyder, at produktet og elektronisk tilbehør hertil (f.eks. oplader, hovedsæt, USB-ledning) ikke må bortskaffes sammen med almindeligt husholdningsaffald efter endt levetid. For at undgå skadelige miljø- eller sundhedspåvirkninger på grund af ukontrolleret affaldsbortskaffelse skal ovennævnte bortskaffes særskilt fra andet affald og indleveres behørigt til fremme for bæredygtig materialegenvinding. Forbrugere bedes kontakte forhandleren, hvor de har købt produktet, eller kommunen for oplysning om, hvor og hvordan de kan indlevere ovennævnte med henblik på miljøforsvarlig genvinding. Virksomheder bedes kontakte leverandøren og læse betingelserne og vilkårene i købekontrakten. Dette produkt og elektronisk tilbehør hertil bør ikke bortskaffes sammen med andet erhvervsaffald.

[Dansk]



Korrekt avhending av dette produktet (Avfall fra elektrisk og elektronisk utstyr)

Denne merkingen som vises på produktet, dets tilbehør eller dokumentasjon, indikerer at produktet eller det elektroniske tilbehøret (for eksempel lader, headset, USB-kabel) ei saa høvittåå kotilousjåtteen mukana niiden käyttöön päätyttyä. Virheellisestä jätteenkäsittelystä ympäristölle ja terveydelle aiheutuvien haittojen välttämiseksi tuote ja lisävarusteet on erotettava muusta jätteestä ja kierrätettävä kestävästi kehityksen muukaista uusiokäyttöä varten. Kotikäyttäjät saavat lisätietoja tuotteen ja lisävarusteiden turvallisesta kierrätyksestä ottamalla yhteyttä tuotteita myyneeseen jälleenmyyjään tai paikalliseen ympäristöviranomaiseen. Yrityskäyttäjien tulee ottaa yhteyttä tavarantuntijaan ja selvittää hankintasopimuksen ehdot. Tuotetta tai sen lisävarusteita ei saa høvittåå muun kaupallisen jätteen seassa.

[Norsk]



Tuotteen turvallinen hävittäminen (elektronikka ja sähkölaitteet)

Oheinen merkintä tuotteessa, lisävarusteissa tai käyttöohjeessa merkitsee, että tuotetta tai lisävarusteina toimitettavia sähkölaitteita (esim. laturia, kuulokkeita tai USB kaapelia) ei saa høvittåå kotilousjåtteen mukana niiden käyttöön päätyttyä. Virheellisistä jätteenkäsittelystä ympäristölle ja terveydelle aiheutuvien haittojen välttämiseksi tuote ja lisävarusteet on erotettava muusta jätteestä ja kierrätettävä kestävästi kehityksen muukaista uusiokäyttöä varten. Kotikäyttäjät saavat lisätietoja tuotteen ja lisävarusteiden turvallisesta kierrätyksestä ottamalla yhteyttä tuotteita myyneeseen jälleenmyyjään tai paikalliseen ympäristöviranomaiseen. Yrityskäyttäjien tulee ottaa yhteyttä tavarantuntijaan ja selvittää hankintasopimuksen ehdot. Tuotetta tai sen lisävarusteita ei saa høvittåå muun kaupallisen jätteen seassa.

[Suomi]



A termék hulladékba helyezésenek módszere(WEEE – Elektromos és elektronikus berendezések hulladékai)

Ez a jelzés a terméken, tartozékain vagy dokumentációján arra utal, hogy hasznos élettartama végén a terméket és elektronikus tartozékait (pl. töltőegység, fejhallgató, USB kábel) nem szabad a háztartási hulladékkal együtt kidobni. A szabálytalan hulladékba helyezés által okozott környezeti- és egészségkárosodás megelőzése érdekében ezeket a tárgyakat különítse el a többi hulladéktól, és felelősségteljesen gondoskodjon az újrahasznosításukról az anyagi erőforrások fenntartható újrafelhasználásának elősegítése érdekében. A háztartási felhasználók a termék forgalmazójától vagy a helyi önkormányzati szervektől kérjenek tanácsot arra vonatkozóan, hová és hogyan vihetik el az elhasznált termékeket a környezetvédelmi szempontból biztonságos újrahasznosítás céljából. Az üzleti felhasználók lépjenek kapcsolatba beszállítójukkal, és vizsgálják meg az adásvételi szerződés feltételeit. Ezt a terméket és tartozékait nem szabad az egyéb közületi hulladékkal együtt kezelni.

[Magyar]



Pravidlowe usuwanie produktu (zużyty sprzęt elektryczny i elektroniczny)

To oznaczenie umieszczone na produkcie, akcesoriach lub dokumentacji oznacza, że po zakończeniu eksploatacji nie należy tego produktu ani jego akcesoriów (np. ładowarki, zestawu słuchawkowego, przewodu USB) wyrzucać wraz ze zwykłymi odpadami gospodarstwa domowego. Aby uniknąć szkodliwego wpływu na środowisko naturalne i zdrowie ludzi wskutek niekontrolowanego usuwania odpadów, prosimy o oddzielenie tych przedmiotów od odpadów innego typu oraz o odpowiedzialny recykling i praktykowanie ponownego wykorzystania materiałów. W celu uzyskania informacji na temat miejsca i sposobu bezpiecznego dla środowiska recyklingu tych przedmiotów, użytkownicy w gospodarstwach domowych powinni skontaktować się z punktem sprzedaży detalicznej, w którym dokonali zakupu produktu, lub z organem władz lokalnych. Użytkownicy w firmach powinni skontaktować się ze swoim dostawcą i sprawdzić warunki umowy zakupu. Produktu ani jego akcesoriów nie należy usuwać razem z innymi odpadami komercyjnymi.

[Polski]



Σωστή Απόρριψη αυτού του Προϊόντος (Απόβλητα Ηλεκτρικού & Ηλεκτρονικού Εξοπλισμού)

(Ισχύει για την Ευρωπαϊκή Ένωση και για άλλες ευρωπαϊκές χώρες με χωριστά συστήματα συλλογής) Αυτό το σήμα που εμφανίζεται επάνω στο προϊόν, στα εξαρτήματά του ή στα εγχειρίδια που το συνοδεύουν, υποδεικνύει ότι το προϊόν και τα ηλεκτρονικά του εξαρτήματα (π.χ. φορτιστής, ακουστικά, καλώδιο USB) δεν θα πρέπει να ρίπνονται μαζί με τα υπόλοιπα οικιακά απορρίμματα μετά το τέλος του κύκλου ζωής τους. Προκειμένου να αποφευχθούν ενδεχόμενες βλαβερές συνέπειες στο περιβάλλον ή την υγεία εξαιτίας της ανεξέλεγκτης διάθεσης απορριμμάτων, σας παρακαλούμε να διαχωρίσετε αυτά τα προϊόντα από άλλους τύπους απορριμμάτων και να τα ανακυκλώσετε, ώστε να βοηθήσετε στην βιώσιμη επαναχρησιμοποίηση των υλικών πόρων. Οι οικιακοί χρήστες θα πρέπει να έλθουν σε επικοινωνία είτε με το κατάστημα απ' όπου αγόρασαν αυτό το προϊόν, είτε με τις κατά τόπους υπηρεσίες, προκειμένου να πληροφορηθούν τις λεπτομέρειες σχετικά με τον τόπο και τον τρόπο με τον οποίο μπορούν να δώσουν αυτά τα προϊόντα για ασφαλή προς το περιβάλλον ανακύκλωση. Οι επιχειρήσεις-χρήστες θα πρέπει να έλθουν σε επαφή με τον προμηθευτή τους και να ελέγξουν τους όρους και τις προϋποθέσεις του συμβολαίου αγοράς. Αυτό το προϊόν και τα ηλεκτρονικά του εξαρτήματα δεν θα πρέπει να αναμειγνύονται με άλλα συνθησιμένα απορρίμματα προς διάθεση.

[Ελληνικά]

Правилно третиране на изделието след края на експлоатационния му живот

(Отпадъци, представляващи електрическо и електронно оборудване)(Важи за държавите на Европейския съюз и други европейски държави със системи за разделно сметосъбиране)



Този знак, поставен върху изделието, негови принадлежности или печатни материали, означава, че продуктът и принадлежностите (например зарядно устройство, слушалки, USB кабел) не бива да се изхвърлят заедно с другите битови отпадъци, когато изтече експлоатационният му живот. Отделяйте тези устройства от другите видове отпадъци и ги предавайте за рециклиране. Спазвайки това правило не излагате на опасност здравето на други хора и предпазвате околната среда от замърсяване, предизвикано от неконтролно изхвърляне на отпадъци. Освен това, подобно отговорно поведение създава възможност за повторно (екологично съобразно) използване на материалните ресурси. Домашните потребители трябва да се свържат с търговеца на дребно, от когото са закупили изделието, или със съответната местна държавна агенция, за да получат подробни инструкции къде и кога могат да занесат тези устройства за рециклиране, безопасно за околната среда. Корпоративните потребители следва да се свържат с доставчика си и да проверят условията на договора за покупка. Това изделие и неговите електронни принадлежности не бива да се смесват с другите отпадъци на търговското предприятие.

[Български]

Správná likvidace výrobku (Elektrický a elektronický odpad)

Toto označení na výrobku, jeho příslušenství nebo dokumentaci znamená, že výrobek a jeho elektronické příslušenství (například nabíječku, náhlavní sadu, USB kabel) je po skončení životnosti zakázáno likvidovat jako běžný komunální odpad. Možným negativním dopadům na životní prostředí nebo lidské zdraví způsobeným nekontrolovanou likvidací zabráníte oddělením zmíněných produktů od ostatních typů odpadu a jejich zodpovědnou recyklací za účelem udržitelného využívání druhotných surovin. Uživatelé z řad domácností by si měli od prodejce, u něhož produkt zakoupili, nebo u příslušného městského úřadu vyžádat informace, kde a jak mohou tyto výrobky odevzdat k bezpečné ekologické recyklaci. Podnikoví uživatelé by měli kontaktovat dodavatele a zkontrolovat všechny podmínky kupní smlouvy. Tento výrobek a jeho elektronické příslušenství nesmí být likvidován spolu s ostatním průmyslovým odpadem.

[Čeština]

Správná likvidácia tohoto výrobku (Elektrotechnický a elektronický odpad)

(Platné pre Európsku úniu a ostatné európske krajiny so systémom triedeného odpadu)



Toto označenie na výrobku, príslušenstve alebo v sprievodnej brožúre hovorí, že po skončení životnosti by produkt ani jeho elektronické príslušenstvo (napr. nabíjačka, náhlavná súprava, USB kábel) nemali byť likvidované s ostatným domovým odpadom. Prípadnému poškodeniu životného prostredia alebo ľudského zdravia môžete predísť tým, že budete tieto výrobky oddeľovať od ostatného odpadu a vrátite ich na recykláciu. Používatelia v domácnostiach by pre podrobnejšie informácie, ako ekologicky bezpečne naložiť s týmito výrobkami, mali kontaktovať buď predajcu, ktorý im ich predal, alebo príslušný úrad v mieste ich bydliska. Priemyselní používatelia by mali kontaktovať svojho dodávateľa a preveriť si podmienky kúpnej zmluvy. Tento výrobok a ani jeho elektronické príslušenstvo by nemali byť likvidované spolu s ostatným priemyselným odpadom.

[Slovensky]

Cum se elimină corect acest produs (Deșeurii de echipamente electrice și electronice)

(Aplicabil în țările Uniunii Europene și în alte țări cu sisteme de colectare selectivă)



Acest simbol de pe produs, accesorii și documentație indică faptul că produsul și accesoriile sale electronice (încărcător, căști, cablu USB) nu trebuie eliminate împreună cu alte deșeurii menajere la finalul duratei lor de utilizare. Dat fiind că eliminarea necontrolată a deșeurilor poate dăuna mediului înconjurător sau sănătății umane, vă rugăm să separați aceste articole de alte tipuri de deșeurii și să le reciclați în mod responsabil, promovând astfel reutilizarea durabilă a resurselor materiale. Utilizatorii casnici trebuie să-l contacteze pe distribuitorul care le-a vândut produsul sau să se intereseze la autoritățile locale unde și cum pot să ducă aceste articole pentru a fi reciclate în mod ecologic. Utilizatorii comerciali trebuie să-și contacteze furnizorul și să consulte termenii și condițiile din contractul de achiziție. Acest produs și accesoriile sale electronice nu trebuie eliminate împreună cu alte deșeurii comerciale.

[Română]

Izstrādājuma pareiza likvidēšana (Attiecās uz nolietotām elektriskām un elektroniskām ierīcēm)

(Spēkā Eiropas Savienībā un pārējās Eiropas valstīs, kas izmanto atkritumu dalītu savākšanu)



Šis uz izstrādājuma un tā piederumiem vai pievienotajā dokumentācijā izvietotais marķējums norāda, ka izstrādājumu un tā elektroniskos piederumus (piem., uzlādes ierīci, austiņas, USB kabeli) pēc ekspluatācijas laika beigām nedrīkst likvidēt kopā ar citiem sadzīves atkritumiem. Lai nepieļautu atkritumu nekontrolētas likvidēšanas radītu varbūtēju kaitējumu videi un cilvēku veselībai, lūdzam minētās ierīces nošķirt no citiem atkritumiem un disciplinēti nodot pienācīgai pārstrādei, tā sekmējot materiālo resursu atkārtotu izmantošanu. Lai uzzinātu, kur un kā minētās ierīces iespējams nodot ekoloģiski drošai pārstrādei, māsainniecībām jāsasazinās ar izstrādājuma pārdevēju vai savu pašvaldību. Iestādēm un uzņēmumiem jāsasazinās ar izstrādājuma piegādātāju un jāiepazīstas ar pirkuma līguma nosacījumiem. Izstrādājumu un tā elektroniskos piederumus nedrīkst nodot likvidēšanai kopā ar citiem iestāžu un uzņēmumu atkritumiem.

[Latviešu]

Tinkamas šio gaminio išmetimas (elektros ir elektroninės įrangos atliekos)

Šis ženklas, pateiktas ant gaminio, jo priedų ar dokumentacijosje, nurodo, kad gaminio ir jo elektroninių priedų (pvz., įkroviklio, ausinių, USB kabelio) negalima išmesti kartu su kitomis buitinėmis atliekomis gaminio naudojimo laikui pasibaigus. Kad būtų išvengta galimos nekontroliuojamo atliekų išmetimo žalos aplinkai arba žmonių sveikatai ir skatinamas aplinką tausojantis antrinių žaliavų panaudojimas, atskirkite šiuos elementus nuo kitų rūšių atliekų ir atiduokite perdirbti. Informacijos kur ir kaip pristatyti šiuos elementus saugiai perdirbti, privatiūs vartotojai turėtų kreiptis į parduotuvę, kurioje šį gaminį pirkto, arba į vietos valdžios institucijas. Verslo vartotojai turėtų kreiptis į savo tiekėjų ir peržiūrėti pirkimo sutarties sąlygas. Tvarkant atliekas, šio gaminio ir jo elektroninių priedų negalima maišyti su kitomis pramoninėmis atliekomis.

[Lietuvių]



Õige viis toote kasutuselt kõrvaldamiseks (elektriliste ja elektrooniliste seadmete jäätmed)

Selline tähistus tootel või selle tarvikutel või dokumentidel näitab, et toodet ega selle elektroonilisi tarvikuid (nt laadija, peakomplekt, USB-kaabel) ei tohi kasutusaja lõppemisel kõrvaldada koos muude olmejäätmetega. Selleks et vältida jäätmete kontrollimatu kõrvaldamisega seotud võimaliku kahju tekitamist keskkonnale või inimeste tervisele ning edendada materiaalsete vahendite säästvat taaskasutust, eraldage need esemed muudest jäätmetest ja suunake need vastutustundlikult taasinglusse. Kodukasutajad saavad teavet nende esemete keskkonnohutu ringlussevõtu kohta kas toote müüjalt või keskkonnaametist. Firmed peaksid võtma ühendust tarnijaga ning kontrollima ostulepingu tingimusi ja sätteid. Toodet ega selle elektroonilisi tarvikuid ei tohi panna muude hävitamiseks mõeldud kaubandusjäätmete hulka.

[Eesti]



Correct disposal of batteries in this product

(Applicable in the European Union and other European countries with separate battery return systems.)

This marking on the battery, manual or packaging indicates that the batteries in this product should not be disposed of with other household waste at the end of their working life. Where marked, the chemical symbols Hg, Cd or Pb indicate that the battery contains mercury, cadmium or lead above the reference levels in EC Directive 2006/66. If batteries are not properly disposed of, these substances can cause harm to human health or the environment. To protect natural resources and to promote material reuse, please separate batteries from other types of waste and recycle them through your local, free battery return system.

[English]



Elimination des batteries de ce produit

(Applicable aux pays de l'Union européenne et aux autres pays européens dans lesquels des systèmes de collecte sélective sont mis en place.)

Le symbole sur la batterie, le manuel ou l'emballage indique que les batteries de ce produit ne doivent pas être éliminées en fin de vie avec les autres déchets ménagers. L'indication éventuelle des symboles chimiques Hg, Cd ou Pb signifie que la batterie contient des quantités de mercure, de cadmium ou de plomb supérieures aux niveaux de référence stipulés dans la directive CE 2006/66. Si les batteries ne sont pas correctement éliminées, ces substances peuvent porter préjudice à la santé humaine ou à l'environnement. Afin de protéger les ressources naturelles et d'encourager la réutilisation du matériel, veillez à séparer les batteries des autres types de déchets et à les recycler via votre système local de collecte gratuite des batteries.

[Français]



Korrekte Entsorgung der Batterien dieses Produkts

(In den Ländern der Europäischen Union und anderen europäischen Ländern mit einem separaten Altbatterie-Rücknahmesystem)

Die Kennzeichnung auf der Batterie bzw. auf der dazugehörigen Dokumentation oder Verpackung gibt an, dass die Batterie zu diesem Produkt nach seiner Lebensdauer nicht zusammen mit dem normalen Haushaltsmüll entsorgt werden darf. Wenn die Batterie mit den chemischen Symbolen Hg, Cd oder Pb gekennzeichnet ist, liegt der Quecksilber-, Cadmium- oder Blei-Gehalt der Batterie über den in der EG-Richtlinie 2006/66 festgelegten Referenzwerten. Wenn Batterien nicht ordnungsgemäß entsorgt werden, können sie der menschlichen Gesundheit bzw. der Umwelt schaden. Bitte helfen Sie, die natürlichen Ressourcen zu schützen und die nachhaltige Wiederverwertung von stofflichen Ressourcen zu fördern, indem Sie die Batterien von anderen Abfällen getrennt über Ihr örtliches kostenloses Altbatterie-Rücknahmesystem entsorgen.

[Deutsch]



Correcte behandeling van een gebruikte accu uit dit product

(Van toepassing op de Europese Unie en andere Europese landen met afzonderlijke inzamelingsystemen voor accu's en batterijen.)

Dit merktken op de accu, handleiding of verpakking geeft aan dat de accu in dit product aan het einde van de levensduur niet samen met ander huishoudelijk afval mag worden weggegooid. De chemische symbolen Hg, Cd of Pb geven aan dat het kwik-, cadmium- of loodgehalte in de accu hoger is dan de referentieniveaus in de Richtlijn 2006/66/EC. Indien de gebruikte accu niet op de juiste wijze wordt behandeld, kunnen deze stoffen schadelijk zijn voor de gezondheid van mensen of het milieu. Ter bescherming van de natuurlijke hulpbronnen en ter bevordering van het hergebruik van materialen, verzoeken wij u afgedankte accu's en batterijen te scheiden van andere soorten afval en voor recycling aan te bieden bij het gratis inzamelingsstelsel voor accu's en batterijen in uw omgeving.

[Nederlands]



Corretto smaltimento delle batterie del prodotto

(Applicabile nei paesi dell'Unione Europea e in altri paesi europei con sistemi di conferimento differenziato delle batterie.)

Il marchio riportato sulla batteria o sulla sua documentazione o confezione indica che le batterie di questo prodotto non devono essere smaltite con altri rifiuti domestici al termine del ciclo di vita. Dove raffigurati, i simboli chimici Hg, Cd o Pb indicano che la batteria contiene mercurio, cadmio o piombo in quantità superiori ai livelli di riferimento della direttiva UE 2006/66. Se le batterie non vengono smaltite correttamente, queste sostanze possono causare danni alla salute umana o all'ambiente. Per proteggere le risorse naturali e favorire il riutilizzo dei materiali, separare le batterie dagli altri tipi di rifiuti e riciclarle utilizzando il sistema di conferimento gratuito previsto nella propria area di residenza.

[Italiano]



Eliminación correcta de las baterías de este producto

(Aplicable en la Unión Europea y en otros países europeos con sistemas de recogida selectiva de baterías.)

La presencia de esta marca en las baterías, el manual o el paquete del producto indica que cuando haya finalizado la vida útil de las baterías no deberán eliminarse junto con otros residuos domésticos. Los símbolos químicos Hg, Cd o Pb, si aparecen, indican que la batería contiene mercurio, cadmio o plomo en niveles superiores a los valores de referencia admitidos por la Directiva 2006/66 de la Unión Europea. Si las baterías no se desechan convenientemente, estas sustancias podrían provocar lesiones personales o dañar el medioambiente. Para proteger los recursos naturales y promover el reciclaje, separe las baterías de los demás residuos y reciclelas mediante el sistema de recogida gratuito de su localidad.

[Español]



Eliminação correcta das baterias existentes neste produto

(Aplicável na União Europeia e noutros países europeus com sistemas de recolha de baterias separados.)

Esta marca, apresentada na bateria, manual ou embalagem, indica que as baterias existentes neste produto não devem ser eliminadas juntamente com os resíduos domésticos indiferenciados no final do seu período de vida útil. Onde existentes, os símbolos químicos Hg, Cd ou Pb indicam que a bateria contém mercúrio, cádmio ou chumbo acima dos níveis de referência indicados na Directiva CE 2006/66. Se as baterias não forem correctamente eliminadas, estas substâncias poderão ser prejudiciais para a saúde humana ou para o meio ambiente. Para proteger os recursos naturais e promover a reutilização dos materiais, separe as baterias dos outros tipos de resíduos e recicle-as através do sistema gratuito de recolha local de baterias.

[Português]



Ustrezno odstranjevanje baterij v tem izdelku

(Uporabno v EU in ostalih evropskih državah s sistemi ločenega odstranjevanja baterij)

Ta oznaka na bateriji, v navodilih ali na embalaži pomeni, da baterij ob izteku njihove življenjske dobe v tem izdelku ne smete odstraniti skupaj z ostalimi gospodinjstskimi odpadki. Oznake za kemijske elemente Hg, Cd ali Pb pomenijo, da baterija vsebuje živo srebro, kadmij ali svinec v količinah, ki presegajo referenčne nivoje v direktivi EC 2006/66. Če te baterije niso ustrezno odstranjene, te snovi lahko škodujejo zdravju ljudi oziroma okolju. Za zaščito naravnih virov in za vzpodbujanje ponovne uporabe materialov prosimo, ločite te baterije od ostalih odpadkov in jih oddajte na predvidenih lokalnih zbirnih reciklažnih mestih.

[Slovenščina]



Korrekt avfallshantering av batterierna i denna produkt

(Gäller EU och andra europeiska länder med särskild batteriåtervinning.) Denna markering på batteriet, i manualen eller på förpackningen

anger att batterierna i denna produkt inte bör slängas tillsammans med annat hushållsavfall. De kemiska symbolerna Hg, Cd eller Pb visar i förekommande fall att batterierna innehåller kvicksilver, kadmium eller bly i mängder överstigande de gränsvärden som anges i EU-direktivet 2006/66. Om batterierna inte slängs på ett ansvarsfullt sätt kan dessa substanser utgöra en fara för hälsa eller miljö. Hjälptill att skydda naturresurser och bidra till materialåtervinning genom att sortera batterierna separat från annat avfall och lämna in dem på en återvinningsstation.

[Svenska]

KKorrekt bortscaffelse af batterierne i dette produkt



(Gælder i EU og andre europæiske lande med særlige retursystemer for batterier.)

Mærket på dette batteri, dokumentationen eller emballagen betyder, at batterierne i dette produkt efter endt levetid ikke må bortscaffes sammen med andet husholdningsaffald. Mærkning med de kemiske symboler Hg, Cd eller Pb betyder, at batteriet indeholder kviksølv, cadmium eller bly over grænseværdierne i EU-direktiv 2006/66. Hvis batterierne ikke bortscaffes korrekt, kan disse stoffer være skadelige for menneskers helbred eller miljøet. For at beskytte naturens ressourcer og fremme genbrug, skal batterier holdes adskilt fra andre typer affald og genanvendes via dit lokale, gratis batteriretursystem.

[Dansk]

Korrekt afhending av batterier i dette produkt



(Kommer til anvendelse i Den europeiske union og i andre europeiske land med separate systemer for retur av batterier.)

Denne merkingen på batteriet, håndboken eller emballasjen angir at batteriene i dette produktet ikke skal kastes sammen med annet husholdningsavfall ved slutten av sin levetid. Der det er merket, angir de kjemiske symbolene Hg, Cd eller Pb at batteriet inneholder kviksølv, cadmium eller bly over referansenivåene i EF-direktiv 2006/66. Hvis batteriene ikke avhendes på riktig måte, kan disse stoffene skade menneskers helse eller miljøet. For å beskytte naturressurser og for å fremme gjenbruk av materialer, ber vi deg adskille batterier fra andre typer avfall og resirkulere dem ved å levere dem på din lokale, gratis mottaksstasjon.

[Norsk]

Tuotteen paristojen oikea hävittäminen



(Koskee Euroopan Unionia ja muita Euroopan maita, joissa on erillinen paristojen palautusjärjestelmä.)

Pariston, käyttöoppaan tai pakkauksen tämä merkintä tarkoittaa, että tämän tuotteen sisältämiä paristoja ei saa hävittää muun kotitalousjätteen seassa, kun niiden käyttöikä on päättynyt. Kemiaallinen symboli Hg, Cd tai Pb ilmaisee, että paristo sisältää elohopeaa, kadmiumia tai lyijyä ylin EU:n direktiivien 2006/66 viiterajojen. Jos paristoja ei hävitetä oikein, nämä aineet voivat vahingoittaa ihmisten terveyttä tai ympäristöä. Suojaa luonnonvaroja ja edistä materiaalien uusiokäyttöä - erottele paristot muusta jätteestä ja toimita ne kierrätettäväksi paikalliseen maksuttomaan paristojen palautusjärjestelmään.

[Suomi]

A termékhez tartozó akkumulátorok megfelelő ártalmatlanítása



(Az Európai Unió területén és más, önálló akkumulátorleadó rendszerrel rendelkező európai országok területén alkalmazandó.)

Az akkumulátoron, a kézikönyvön vagy a csomagoláson szereplő jelzés arra utal, hogy hasznos élettartama végén a terméket nem szabad egyéb háztartási hulladékkal együtt kidobni. Ahol szerepel a jelzés, a Hg, Cd vagy Pb kémiai elemjelölések arra utalnak, hogy az akkumulátor az EK 2006/66. számú irányelvben rögzített referenciaszintet meghaladó mennyiségű higanyt, kadmiumot vagy ólmot tartalmaz. Az akkumulátorok nem megfelelő kezelése esetén ezek az anyagok veszélyt jelenthetnek az egészségre vagy a környezetre. A természeti erőforrások megóvása és az anyagok újrafelhasználásának ösztönzése érdekében kérjük, különítse el az akkumulátorokat a többi hulladéktól és vigye vissza a helyi, ingyenes akkumulátorleadó helyre.

[Magyar]

Spósob poprawnego usuwania baterii, w które wyposażony jest niniejszy produkt



(Dotyczy obszaru Unii Europejskiej oraz innych krajów europejskich posiadających oddzielne systemy zwrotu zużytych baterii.)

Niniejsze oznaczenie na baterii, instrukcji obsługi lub opakowaniu oznacza, że po upływie okresu użytkowania baterie, w które wyposażony był dany produkt, nie mogą zostać usunięte wraz z innymi odpadami pochodzącymi z gospodarstw domowych. Przy zastosowaniu takiego oznaczenia symbole chemiczne (Hg, Cd lub Pb) wskazują, że dana bateria zawiera rtęć, kadm lub ołów w ilości przewyższającej poziomy odniesienia opisane w dyrektywie WE 2006/66. Jeśli baterie nie zostaną poprawnie zutilizowane, substancje te mogą powodować zagrożenie dla zdrowia ludzkiego lub środowiska naturalnego. Aby chronić zasoby naturalne i promować ponowne wykorzystanie materiałów, należy oddzielać baterie od innego typu odpadów i poddawać je utylizacji poprzez lokalny, bezpłatny system zwrotu baterii.

[Polski]

Σωστή απόρριψη των μπαταριών αυτού του προϊόντος



(Ισχύει στην Ευρωπαϊκή Ένωση και άλλες ευρωπαϊκές χώρες με συστήματα ξεχωριστής ανακύκλωσης μπαταριών.)

Αυτή η επίσημη σήμανση πάνω στη μπαταρία, το εγχειρίδιο ή τη συσκευασία υποδεικνύει ότι οι μπαταρίες αυτού του προϊόντος δεν πρέπει να απορρίπτονται μαζί με άλλα οικιακά απορρίμματα στο τέλος του κύκλου ζωής τους. Όπου υπάρχουν, τα χημικά σύμβολα Hg, Cd ή Pb υποδεικνύουν ότι η μπαταρία περιέχει υδράργυρο, κάδμιο ή μόλυβδο πάνω από τα επίπεδα αναφοράς της Ευρωπαϊκής Οδηγίας 2006/66. Αν οι μπαταρίες δεν απορριφθούν σωστά, αυτές οι ουσίες ενδέχεται να προκαλέσουν βλαβερές συνέπειες στην ανθρώπινη υγεία ή το περιβάλλον. Παρακαλούμε διαχωρίζετε τις μπαταρίες από άλλους τύπους απορριμμάτων και ανακυκλώνετε τις μέσω του τοπικού σας, δωρεάν συστήματος ανακύκλωσης μπαταριών, για την προστασία των φυσικών πόρων και την προώθηση της επαναχρησιμοποίησης υλικών.

[Ελληνικά]

Правилно изхвърляне на батериите в този продукт



(Приложимо в Европейския съюз и други европейски държави със самостоятелни системи за връщане на батерии.)

Това обозначение върху батериията, ръководството или опаковката, показва, че батериите в този продукт не бива да се изхвърлят с другите битови отпадъци в края на техния полезен живот. Където са маркирани, химическите символи Hg, Cd или Pb показват, че батериията съдържа живак, кадмий или олово над контролните нива в Директива 2006/66 на ЕО. Ако батериите не се изхвърлят правилно, тези вещества могат да предизвикат увреждане на човешкото здраве или на околната среда. За да предпазите природните ресурси и за да съдействате за многократната употреба на материалните ресурси, моля отделяйте батериите от другите видове отпадъчни продукти и ги рециклирайте посредством Вашата локална система за безплатно връщане на батерии.

[Български]

Správná likvidace baterií v tomto výrobku

(Platí v Evropské unii a dalších evropských zemích s vlastními systémy zpětného odběru baterií.)



Tato značka na baterii, návodu nebo obalu znamená, že baterie v tomto výrobku nesmí být na konci své životnosti likvidovány společně s jiným domovním odpadem. Případně vyznačené symboly chemikálií Hg, Cd nebo Pb upozorňují na to, že baterie obsahuje rtuť, kadmium nebo olovo v množství překračujícím referenční úroveň stanovené směnicí ES 2006/66. Pokud baterie nejsou správně zlikvidovány, mohou tyto látky poškodit zdraví osob nebo životní prostředí. Pro ochranu přírodních zdrojů a pro podporu opakovaného využívání materiálů oddělte, prosím, baterie od ostatních typů odpadu a nechte je recyklovat prostřednictvím místního bezplatného systému zpětného odběru baterií.

[Čeština]

Správná likvidácia baterií v tomto výrobku

(Aplikovateľné v krajinách Európskej únie a v ostatných európskych krajinách, v ktorých existujú systémy separovaného zberu baterií.)



Toto označenie na batérii, príručke alebo balení hovorí, že batérie v tomto výrobku by sa po skončení ich životnosti nemali likvidovať spolu s ostatným domovým odpadom. V prípade takéhoto označenia chemické symboly Hg, Cd alebo Pb znamenajú, že batéria obsahuje ortuť, kadmium alebo olovo v množstve presahujúcom referenčné hodnoty smernice 2006/66/ES. Pri nevhodnej likvidácii batérií môžu tieto látky poškodiť zdravie alebo životné prostredie. Za účelom ochrany prírodných zdrojov a podpory opätovného použitia materiálu batérie likvidujte oddelene od iných typov odpadov a recyklujte ich prostredníctvom miestneho systému bezplatného zberu batérií.

[Slovensky]

Dispoziții privind eliminarea corectă a bateriilor acestui produs

(aplicabile în Uniunea Europeană și în alte țări europene cu sisteme separate de colectare a bateriilor)



Acest marcaj de pe baterie, de pe manualul de utilizare sau de pe ambalaj indică faptul că bateriile acestui produs nu trebuie eliminate împreună cu alte deșeurii menajere la sfârșitul ciclului lor de viață. Dacă sunt marcate, simbolurile chimice Hg, Cd sau Pb indică faptul că bateria conține mercur, cadmiu sau plumb peste nivelurile de referință prevăzute în Directiva CE 2006/66. În cazul în care bateriile nu sunt eliminate corespunzător, aceste substanțe pot fi dăunătoare pentru sănătatea omului sau pentru mediu. În vederea protejării resurselor naturale și a promovării refolosirii materialelor, vă rugăm să separați bateriile de celelalte tipuri de deșeurii și să le reciclați prin intermediul sistemului gratuit de returnare a bateriilor la nivel local.

[Română]

Ši izstrādājuma bateriju pareiza utilizācija

(Piemērojama Eiropas Savienībā un citās Eiropas valstīs ar atsevišķām bateriju nodošanas sistēmām.)



Šis marķējums uz baterijas, rokasgrāmatā vai uz iepakojuma norāda, ka šī izstrādājuma bateriju pēc tās kalpošanas laika beigām nedrīkst izmest ar citiem sadzīves atkritumiem. Ja uz baterijas ir atzīmēti ķīmiskie simboli, piem., Hg, Cd vai Pb, tie norāda, ka baterija satur dzīvsudrabu, kadmiju vai svīnu, kura saturs ir lielāks par EK Direktīvā 2006/66 minētajiem līmeņiem. Ja baterijas tiek nepareizi likvidētas, šīs vielas var radīt kaitējumu cilvēku veselībai vai videi. Lai aizsargātu dabas resursus un veicinātu materiālu atbilstošu izmantošanu, šķirojiet baterijas atsevišķi no citiem atkritumu veidiem un nododiet tās atbilstoši pārstrādei, izmantojot bateriju vietējo bezmaksas nodošanas sistēmu.

[Lietuvių]

Tinkamas šio produkto akumuliatorių tvarkymas

(Taikoma Europos Sąjungoje ir kitose Europos šalyse, kuriose galioja atskiro akumuliatorių gražinimo sistemos.)



Šis ženklas yra pateikiamas ant akumuliatoriaus, jo dokumentacijoje ar ant pakuotės nurodo, kad šio produkto akumuliatorių, pasibaigus jų tarnavimo laikui, negalima išmesti kartu su kitomis buitinėmis atliekomis. Cheminiai simboliai Hg, Cd arba Pb rodo, kad akumuliatoriuje yra gyvsidabrio, kadmio ar švino, kurio kiekis viršija normą, nurodytą ES direktyvoje 2006/66. Jei akumuliatoriai nebus tinkamai išmesti, šios medžiagos gali sukelti žalos žmonių sveikatai ar aplinkai. Tam, kad būtų apsaugoti gamtos išteklių ir skatinamas antrinių žaliavų panaudojimas, pašone atskirti akumuliatorių nuo kitų rūšių atliekų ir atiduoti perdurti vietinėje akumuliatorių gražinimo sistemoje.

[Lietuvių]

Õige viis toote akude kasutusest kõrvaldamiseks

(Rakendatav Euroopa Liidus ja teistes Euroopa riikides, kus on kasutusel spetsiaalsed akude kogumissüsteemid.)



Selline tähistus akul, dokumentidel või pakendil näitab, et toote akusid ei tohi kasutusaja lõppemisel kõrvaldada koos muude olmejäätmetega. Keemilised elemendid Hg, Cd, või Pb näitavad, et aku elavhõbeda, kaadmiumi või plii sisaldus on EÜ direktiivi 2006/66 sihttasemest suurem. Kui akusid ei kõrvaldata õigel viisil, võib nende sisu põhjustada tervise- või keskkonnakahjustusi. Selleks, et kaitsta loodusvarasid ja edendada materjalide taaskasutamist, eraldage akud muudest jäätmetest ja suunake need taaskasutusse kohaliku, tasuta teenusena pakutava akude tagastussüsteemi abil.

[Eesti]

Free Manuals Download Website

<http://myh66.com>

<http://usermanuals.us>

<http://www.somanuals.com>

<http://www.4manuals.cc>

<http://www.manual-lib.com>

<http://www.404manual.com>

<http://www.luxmanual.com>

<http://aubethermostatmanual.com>

Golf course search by state

<http://golfingnear.com>

Email search by domain

<http://emailbydomain.com>

Auto manuals search

<http://auto.somanuals.com>

TV manuals search

<http://tv.somanuals.com>