

Indoor Unit
NH080PHXEA
NH160PHXEA

DHW Tank
NH200WHXEA
NH300WHXEA
NH200WHXES
NH300WHXES

Air to Water Heat Pump -Hydro Unit user manual



imagine the possibilities

Thank you for purchasing this Samsung product.
To receive more complete service, please
register your product at

www.samsung.com/register

© S F I P D DB98-32035A(2)

SAMSUNG

Features of your Air to water heat pump

- **Quick Heating by TDM Technology**

Floor heating is well known as the optimal heating option for indoor thermal comfort. However, it takes 4-8 hours to heat up the room after it is turned on. Samsung EHS TDM technology quickens that process by blowing hot air along with floor heating to warm up the room.

- **Integrated Heating & Cooling System at a Lower Cost**

Time Division Multi (TDM), a smart alternating operation between air-to-water and air to air, enables one outdoor unit to operate for both functionalities resulting in lower product cost and space saving.

- **Running Costs-Reduction of Up to 33.3%**

Samsung EHS, known for its world class efficiency (11kW floor heating system with COP of 4.55), can reduce 33.3% of your running costs as compared to a gas boiler.

- **Price and Space Reduction of Up to 50%**

With an all-in-one outdoor unit capable of both air-to-water and air-to-air functions, Samsung EHS saves you in terms of the low initial purchase price & installation fee as well as the space needed for an extra outdoor unit.

- **High Performance at Low Temperature**

Samsung EHS is made up of an inverter compressor optimally operated according to the outdoor temperature, offering heating performance of 90% at -10°C and reliable frost protection at -20°C.



For easy future reference, write the model and serial number down. You will find your model number on the bottom right side of the air conditioner.

Model # _____
Serial # _____

Contents







SAFETY PRECAUTIONS	04	Safety precautions
04		
OVERVIEW	07	Control panel
07		
CHECKING THE FUNCTION OF BUTTONS AND ICONS	08	Space operation mode
	09	DHW operation mode
	10	Temperature adjustment
	11	Hot key
	12	Schedule
	13	Status indicator
	14	Optional function indicator
OPERATING BASIC FUNCTION	15	Available mode
	16	Space heating operation
	17	Space cooling operation
	18	Water law
	19	Domestic water heating operation
OPERATING HOT KEY FUNCTION	20	Urgent DHW mode
	21	Outing mode
OPERATING ADVANCED FUNCTION	22	Setting the time
	23	Setting the 7-day(weekly) schedule
	26	Setting the daily schedule
	29	Field setting mode
APPENDIX	43	Temperature table
	43	DIP switch setting
	44	Maintaining the unit
	45	Troubleshooting tips
	48	Product disposal
43		

Safety precautions

Before using your new air conditioner, please read this manual thoroughly to ensure that you know how to safely and efficiently operate the extensive features and functions of your new appliance.

Because the following operating instructions cover various models, the characteristics of your air conditioner may differ slightly from those described in this manual. If you have any questions, call your nearest contact center or find help and information online at www.samsung.com.

Important safety symbols and precautions:

 WARNING	Hazards or unsafe practices that may result in severe personal injury or death .		
 CAUTION	Hazards or unsafe practices that may result in minor personal injury or property damage .		
	Follow directions.		Unplug the power plug from the wall socket.
	Do NOT attempt.		Do NOT disassemble.
	Make sure the machine is grounded to prevent electric shock.		

FOR INSTALLATION

WARNING



Plug the power cord into a wall socket with the power specifications of the product or higher and use the socket for this appliance only. In addition, do not use an extension cord.

- Sharing a wall socket with other appliances using a power strip or extending the power cord may result in electric shock or fire.
- Do not use an electric transformer. It may result in electric shock or fire.
- If the voltage/frequency/rated current condition is different, it may cause fire.

The installation of this appliance must be performed by a qualified technician or service company.

- Failing to do so may result in electric shock, fire, explosion, problems with the product, or injury.

Install a switch and circuit breaker dedicated to the air conditioner.

- Failing to do so may result in electric shock or fire.

Fix the outdoor unit firmly so that the electric part of the outdoor unit is not exposed.

- Failing to do so may result in electric shock or fire.



Do not install this appliance near a heater, inflammable material. Do not install this appliance in a humid, oily or dusty location, in a location exposed to direct sunlight and water (rain drops). Do not install this appliance in a location where gas may leak.

- This may result in electric shock or fire.

Never install the outdoor unit in a location such as on a high external wall where it could fall.

- If the outdoor unit falls, it may result in injury, death or property damage.



This appliance must be properly grounded. Do not ground the appliance to a gas pipe, plastic water pipe, or telephone line.

- Failure to do so may result in electric shock, fire, an explosion, or other problems with the product.
- Never plug the power cord into a socket that is not grounded correctly and make sure that it is in accordance with local and national codes.

FOR INSTALLATION

CAUTION



This appliance should be positioned in such a way that it is accessible to the power plug.

- Failing to do so may result in electric shock or fire due to electric leakage.

Install your appliance on a level and hard floor that can support its weight.

- Failing to do so may result in abnormal vibrations, noise, or problems with the product.

Install the draining hose properly so that water is drained correctly.

- Failing to do so may result in water overflowing and property damage.

When installing the outdoor unit, make sure to connect the draining hose so that draining is performed correctly.

- The water generated during the heating operation by the outdoor unit may overflow and result in property damage. In particular, in winter, if a block of ice falls, it may result in injury, death or property damage.
- The air conditioner should be used only for the applications for which it has been designed: the indoor unit is not suitable to be installed in areas used for laundry.
- Our units must be installed in compliance with the spaces indicated in the installation manual to ensure either accessibility from both sides or ability to perform routine maintenance and repairs. The units' components must be accessible and that can be disassembled in conditions of complete safety either for people or things. For this reason, where it is not observed as indicated into the Installation Manual, the cost necessary to reach and repair the unit (in safety, as required by current regulations in force) with slings, trucks, scaffolding or any other means of elevation won't be considered in-warranty and charged to end user.

FOR POWER SUPPLY

WARNING



Remove all foreign substances such as dust or water from the power plug terminals and contact points using a dry cloth on a regular basis.

- Unplug the power plug and clean it with a dry cloth.
- Failing to do so may result in electric shock or fire.

Plug the power plug into the wall socket in the right direction so that the cord runs towards the floor.

- If you plug the power plug into the socket in the opposite direction, the electric wires within the cable may be damaged and this may result in electric shock or fire.

When the appliance or power plug or power cord is damaged, contact your nearest service center



Plug the power plug into the wall socket firmly. Do not use a damaged power plug, damaged power cord or loose wall socket.

- This may result in electric shock or fire.

Do not pull the power cord, when unplugging the power plug.

- Unplug the power plug by holding the plug.
- Failing to do so may result in electric shock or fire.

Do not pull or excessively bend the power cord. Do not twist or tie the power cord. Do not hook the power cord over a metal object, place a heavy object on the power cord, insert the power cord between objects, or push the power cord into the space behind the appliance.

- This may result in electric shock or fire.

FOR POWER SUPPLY

CAUTION



When not using the air conditioner for a long period of time or during a thunder/lightning storm, cut the power at the circuit breaker.

- Failing to do so may result in electric shock or fire.

FOR USING

WARNING



If the appliance is flooded, please contact your nearest service center.

- Failing to do so may result in electric shock or fire.

If the appliance generates a strange noise, a burning smell or smoke, unplug the power plug immediately and contact your nearest service center.

- Failing to do so may result in electric shock or fire.

In the event of a gas leak (such as propane gas, LP gas, etc.), ventilate immediately without touching the power plug. Do not touch the appliance or power cord.

- Do not use a ventilating fan.
- A spark may result in an explosion or fire.

To reinstall the air conditioner, please contact your nearest service center.

- Failing to do so may result in problems with the product, water leakage, electric shock, or fire.
- A delivery service for the product is not provided. If you reinstall the product in another location, additional construction expenses and an installation fee will be charged.
- Especially, when you wish to install the product in an unusual location such as in an industrial area or near the seaside where it is exposed to the salt in the air, please contact your nearest service center.



Do not touch the power plug or the circuit breaker with wet hands.

- This may result in electric shock.

Do not unplug the power plug or turn the air conditioner off with the circuit breaker while it is operating.

- Plugging the power plug into the wall outlet or turning the air conditioner on from the circuit breaker may cause a spark and result in electric shock or fire.

After unpacking the air conditioner, keep all packaging materials well out of the reach of children, as packaging materials can be dangerous to children.

- If a child places a bag over its head, it may result in suffocation.

Do not insert your fingers or foreign substances into the outlet when the air conditioner is operating.

- Take special care that children do not injure themselves by inserting their fingers into the product.

Do not touch the air flow blade with your hands or fingers during the heating operation.

- This may result in electric shock or burns.

Do not insert your fingers or foreign substances into the air inlet/outlet of the air conditioner.

- Take special care that children do not injure themselves by inserting their fingers into the product.

Do not strike or pull the air conditioner with excessive force.

- This may result in fire, injury, or problems with the product.

Safety information

FOR USING

WARNING



Do not place an object near the outdoor unit that allows children to climb onto the machine.

- This may result in children seriously injuring themselves.

Do not use this air conditioner for long periods of time in badly ventilated locations or near infirm people.

- Since this may be dangerous due to a lack of oxygen, Open a window at least once an hour.

If any foreign substance such as water has entered the appliance, cut the power by unplugging the power plug and turning the circuit breaker off and then contact your nearest service center.

- Failing to do so may result in electric shock or fire.



If any foreign substance such as water has entered the appliance, cut the power by unplugging the power plug and turning the circuit breaker off and then contact your nearest service center.

- Failing to do so may result in electric shock or fire.



Do not attempt to repair, disassemble, or modify the appliance yourself.

- Do not use any fuse (such as cooper, steel wire, etc.) other than the standard fuse.
- Failing to do so may result in electric shock, fire, problems with the product, or injury.

FOR USING

CAUTION



Do not place objects or devices under the indoor unit.

- Water dripping from the indoor unit may result in fire or property damage.

Check that the installation frame of the outdoor unit is not broken at least once a year.

- Failing to do so may result in injury, death or property damage.

Max current is measured according to IEC standard for safety and current is measured according to ISO standard for energy efficiency.



Do not stand on top of the appliance or place objects (such as laundry, lighted candles, lighted cigarettes, dishes, chemicals, metal objects, etc.) on the appliance.

- This may result in electric shock, fire, problems with the product, or injury.

Do not operate the appliance with wet hands.

- This may result in electric shock.

Do not spray volatile material such as insecticide onto the surface of the appliance.

- As well as being harmful to humans, it may also result in electric shock, fire or problems with the product.

Do not drink the water from the air conditioner.

- The water may be harmful to humans.

Do not apply a strong impact to the remote controller and do not disassemble the remote controller.

Do not touch the pipes connected with the product.

- This may result in burns or injury.

Do not use this air conditioner to preserve precision equipment, food, animals, plants or cosmetics, or for any other unusual purposes.

- This may result in property damage.

Avoid directly exposing humans, animals or plants from the air flow from the air conditioner for long periods of time.

- This may result in harm to humans, animals or plants.

This appliance is not intended for use by persons (including children) with reduced physical, sensory or mental capabilities, or lack of experience and knowledge, unless they have been given supervision or instruction concerning use of the appliance by a person responsible for their safety. Children should be supervised to ensure that they do not play with the appliance.

FOR CLEANING

WARNING



Do not clean the appliance by spraying water directly onto it. Do not use benzene, thinner or alcohol to clean the appliance.

- This may result in discoloration, deformation, damage, electric shock or fire.

Before cleaning or performing maintenance, unplug the air conditioner from the wall socket and wait until the fan stops.

- Failing to do so may result in electric shock or fire.

FOR CLEANING

CAUTION



Take care when cleaning the surface of the heat exchanger of the outdoor unit since it has sharp edges.

- To avoid cutting your fingers, wear thick cotton gloves when cleaning it.



Do not clean the inside of the air conditioner by yourself.

- For cleaning inside the appliance, contact your nearest service center.

- When cleaning the internal filter, refer to the descriptions in the 'Cleaning the air conditioner' section.

- Failure to do may result in damage, electric shock or fire.

Overview

CONTROL PANEL

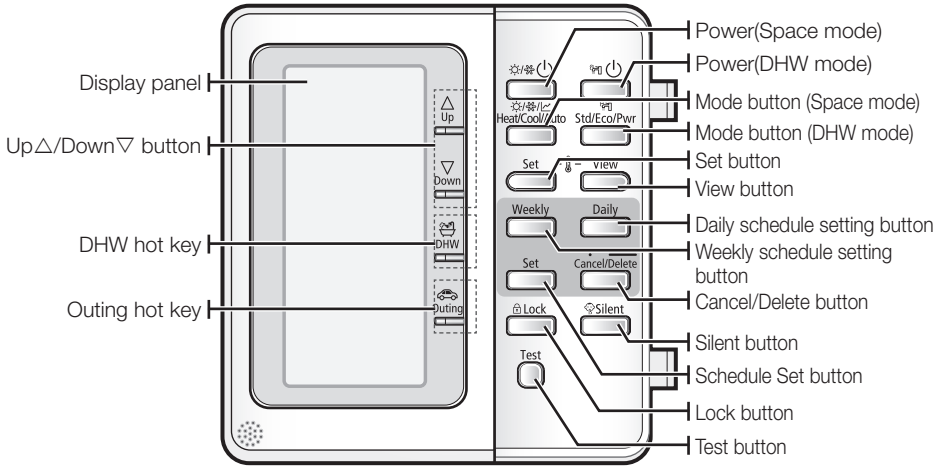

Checking the function of buttons and indicators

SPACE OPERATION MODE

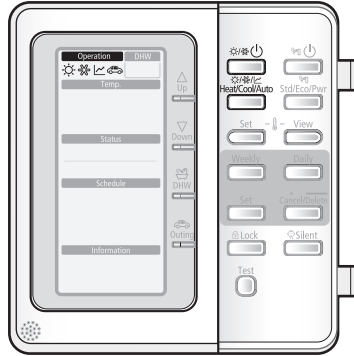







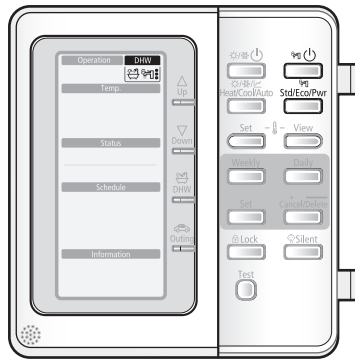

Mode	Button	Display	Function
Operation mode	Space heating & cooling Operation 		It can supply heating and cooling to the space when the Power(Space mode) button is on. Results: The heat pump will run in heating or cooling mode.
	Space mode 	Heating 	Using this wired remote controller, only A2W can be operating with heating mode. A2A should be operated using its own wireless remote controller. If there are heating demands from both A2A and A2W simultaneously, A2A is operating prior to A2W.
		Cooling 	Using this wired remote controller, only A2W can operating with cooling mode. A2A should be operated using its own wireless remote controller. If there are cooling demands from both A2A and A2W simultaneously, A2A is operating prior to A2W.
		Water law 	The supply water temperature to the heating space is operating according to outdoor temperature.

- When you push the **Power(Space mode)** button, it has no influence on the domestic water heating. Domestic water heating only switched on or off according to the **Power(DHW mode)** button.

DHW OPERATION MODE



Mode	Button	Display	Function
Operation mode	Water heating Operation 		It can supply warm water to the DHW tank when the Power(DHW mode) button is pressed. Results: Heat pump will be turned on with the domestic water heating mode.
	DHW mode Economic 		Economic DHW mode, which is heat pump only, saving energy consumption.
	Standard 		Standard DHW mode, which is operated by both heat pump and heater. However heater operating time is still restricted.
	Powerful 		Powerful DHW mode, which is operated by both heat pump and heater. In order to supply warm water more quickly, electric heater is operating immediately.

-  When you push the **Power(Space mode)** button, it has no influence on the domestic water heating. Domestic water heating only switched on or off according to the **Power(DHW mode)** button.

Checking the function of buttons and indicators

TEMPERATURE ADJUSTMENT



Mode	Button	Display	Function
Operation mode	Temperature Adjust Set - - View	Set View	To push up and down, modulate the water (Air) temperature. Supply water temperature to the load Domestic water temperature Room temperature Outdoor temperature Water law temperature Results: The Set or View will be displayed on the controller.
	Set Set	Set	This button is used to find the current setting point which you want to change. According to Dip switch setting and operating modes, Available setting points will be displayed by pressing buttons in order.
	View View	View	Find the temperature which you want to view. → → → → Results : Current temperature will be displayed in order.

HOT KEY

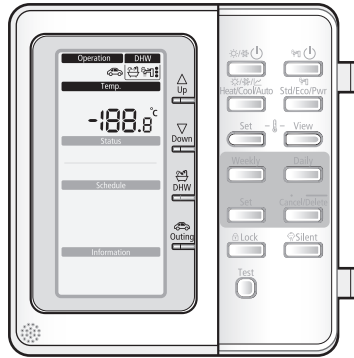

Mode	Button	Display	Function
Hot key	Up 	-18.8 °C	To adjust set point temperature press arrows up or down. Results: The temperature can be set ranges from 5°C to 55°C and be adjusted by 0.5°C.
	Down 		
	DHW 		When DHW mode is enabled, it is assured that the full capacity of the heat pump is used for domestic water heating only. Results: The heat pump is operating for the domestic water only.
	Outing 		Lowers each target temperature of operation modes with pre-defined values stored in the Field Setting Value sector of Wired Remote Controller. Keeps the house at lower temperature to save your running cost, you can use this button while having a vacation.

Checking the function of buttons and indicators

SCHEDULE

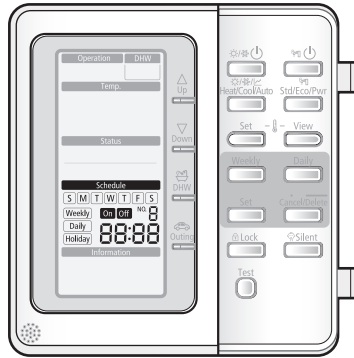

Mode	Button	Display	Function
Schedule	<div style="display: flex; flex-wrap: wrap; gap: 5px;"> <div style="border: 1px solid black; padding: 2px; margin: 2px;">Weekly</div> <div style="border: 1px solid black; padding: 2px; margin: 2px;">Daily</div> <div style="border: 1px solid black; padding: 2px; margin: 2px;">Set</div> <div style="border: 1px solid black; padding: 2px; margin: 2px;">Cancel/Delete</div> </div>	<div style="border: 1px solid black; padding: 2px; margin: 2px;">On Off</div> <div style="border: 1px solid black; padding: 2px; margin: 2px;">Weekly</div> <div style="border: 1px solid black; padding: 2px; margin: 2px;">Daily</div> <div style="border: 1px solid black; padding: 2px; margin: 2px;">Holiday</div>	The system operates according to a certain schedule which is pre-defined by users or installers.

STATUS INDICATOR

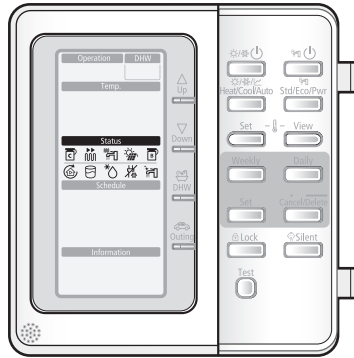

Mode	Status	Display	Function
Status	Compressor On		This icon indicates that the compressor in the outdoor unit is running.
	Back-up heater On		These icons indicate that the back-up heater in the hydro unit is operating on 1 step(2kW) or 2 step(6kW) .
	Booster heater On		This icon indicates that the booster heater in the DHW tank is active(3kW). The icon is not used when the DHW tank is not installed.
	Solar thermal panel On		It indicates when the solar panel is powered on. DHW mode is stopping while solar panel is on in order to save your energy cost.
	Back up boiler On		The Back up boiler shall start to work as soon as outdoor temperature reach to the targeted temperature. Users can adjust the temperature to allow the back up boiler work. The icon shall not be displayed without the Installation of the back up boiler.
	Water pump On		This icon indicates that the water pump in the hydro unit is On.
	Domestic water On		This icon indicates when the domestic water heating mode is operating.
	Defrost operation On		This icon indicates that the defrost mode is active.
	Anti freezing operation On		The system automatically maintains the water temperature above a freezing point to prevent from freezing-fracture of piping system.
	Sanitary operation On		This function disinfects the DHW tank by periodically heating the domestic water to a specific temperature.

Checking the function of buttons and indicators

OPTIONAL FUNCTION INDICATOR

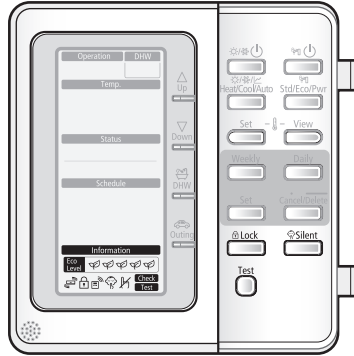

















Mode	Button	Display	Function
Optional function	A2A Operating		A2A has priority while both A2A and A2W are in demand. When the A2A sign is on, the heat pump is only working for A2A.
	Child Lock 		The remote controller buttons can be locked to prevent children from changing the settings or from pressing the buttons by accident.
	Thermostat connected		When the room thermostat is connected, the Water-Law operation is active and the water temperature is determined automatically depending upon the outdoor temperature. The more cold the outdoor temperature, the more warm water will be supplied. vice versa.
	Silent mode 		To maintain the outdoor unit to operate quietly, fan and compressor speed will be limited to a certain value of the speed at a normal operating.
	Not available		This icon is displayed whenever a non-installed option is addressed or a function is not available.
	Test 		Press this button for 5 sec to set Field setting values.
	Energy Indicator		It indicates 5 Eco-level of energy consumption according to heat resources (Solar thermal, Backup boiler and heat pump) and outdoor temperature.

Operating basic function

AVAILABLE MODE

Under the installation of both A2A(Air-To-Air type air conditioner) and A2W(Air-To-Water type hydro unit) at the same time, if our system operates only the heating mode of Air-to-Water Heat Pump, actual performance of our Air-to-Water Heat Pump may be reduced a little as compared with its rated performance. Because the part of the circulating refrigerant amount is bypassed into A2A indoor units during A2W's normal operation.

Heating mode and cooling mode can not operate at the same time.

Heating	Operation	DHW	Cooling	Operation	DHW
					
Water law	Operation	DHW	Heating + DHW	Operation	DHW
					
Cooling + DHW	Operation	DHW	Water law + DHW	Operation	DHW
					
DHW	Operation	DHW	Urgent DHW	Operation	DHW
					
Outing (heating)	Operation	DHW	Outing (heating + DHW)	Operation	DHW
					

Operating basic function

SPACE HEATING OPERATION

In this mode, heating will be activated as required by the water temperature set point.

- The set point can be set manually
- or set weather dependant

1. Press **Power(Space mode)** button to turn on the heat pump unit.

The heat pump will be turned on in the mode you select.

- Space water heating devices: Radiator or Fan coil unit (field supply)



In winter season, the heat pump sometimes goes into defrost mode to prevent from the freezing of the outdoor heat exchanger.



The heat pump has a built-in protection mechanism to prevent the unit from being damaged when it is started immediately after being plugged in or stopped, the heat pump will start up after 3 minutes.

2. Press the **Mode(Space mode)** button once to select the space heating mode.

The heat pump will run on heating mode.

3. Press **Up**▲ or **Down**▼ button to set the desired temperature.

The temperature can be set between 15°C to 55°C.



The temperature is adjusted by 0.5°C.

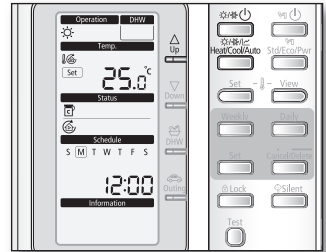

SPACE COOLING OPERATION

In this mode, cooling will be activated as required by the water temperature set point.

- The set point can be set manually
- or set weather dependant

1. Press **Power(Space mode)** button to turn on the heat pump unit.

The heat pump will be turned on in the mode you select.

- Space water cooling devices: Radiator or Fan coil unit (field supply)
- Heating and cooling mode can not be selected at the same time.
- Space cooling operation is not possible if the installation is a heating only installation.



The heat pump has a built-in protection mechanism to prevent the unit from being damaged when it is started immediately after being plugged in or stopped, the heat pump will start up after 3 minutes.

2. Press the **Mode(Space mode)** button twice to select the space cooling mode.

The heat pump will run on cooling mode.

3. Press **Up**▲ or **Down**▼ button to set the desired temperature.

The temperature can be set between 5°C to 25°C.



The temperature is adjusted by 0.5°C.

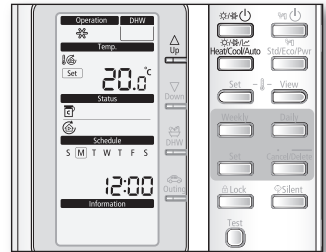

Operating basic function

WATER LAW

In this mode, the heat pump operates according to the parameters for the weather dependent.

- The set point can be set manually
- or set weather dependant

1. Press **Power(Space mode)** button to turn on the heat pump unit.

The heat pump will be turned on in the mode you select.

- Space air heating devices: Radiator or Fan coil unit (field supply)

2. Press the **Mode(Space mode)** button three times to select the mode.

The heat pump will run on heating mode according to the outdoor temperature.

-  When water low is active, the target supply water temperature will be determined automatically depending on the outdoor temperature: for heating mode, colder outdoor temperatures will result in warmer water.

3. Press **Up** Δ or **Down** ∇ button to set the desired temperature.

During water low, the user has the possibility to shift up or down the target water temperature by a maximum of 5°C.

-  The field setting temperature is adjusted by 0.5°C.

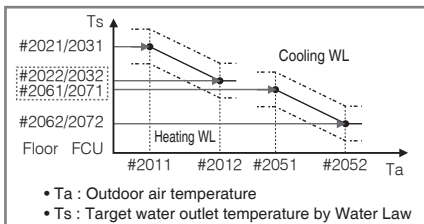
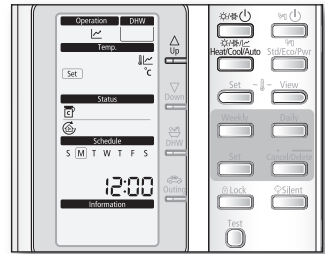

- All the Field Setting Values needed to re-design the water law for floor or FCU(radiator) can be changed by using Wired Remote Controller's Field Setting Mode.
- There are 2 types of water law for each mode, one for floor application, the other for FCU(radiator). Both of them can be selected by using Wired Remote Controller's Field Setting Mode.
- The target water temperatures exceeding the operation limit of heat pump(5~55°C) after reflecting user's arbitrary input(temperature shift) will be neglected, and be kept maximum or minimum respectively.

DOMESTIC WATER HEATING OPERATION

In this mode, domestic water heating will be activated as required by the water temperature set point.

- The set point can be set manually

1. Press **Power(DHW mode)** button to turn on DHW tank.

The priority between heating/cooling/water-law and DHW modes are depending upon the user's input of Field Setting Value of Wired Remote Controller.

The default priority is on the DHW mode.



- This mode can not be used when the DHW tank is not installed.

- The **Power(Space mode)** button and the **Power(DHW mode)** button can be selected at the same time.

- In order to provide domestic hot water throughout the day, it is advised to keep the domestic water heating operation on continuously.
- When the ☀️ icon is displayed, hot water is delivered to the DHW tank by the solar panel. The operation between solar panel and heat pump can be determined by using Wired Remote Controller's Field Setting Mode.

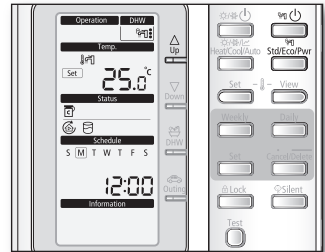

2. Press **Mode(DHW mode)** button until required operating mode is displayed.

The heat pump will run on selected domestic water heating mode.

- Economic domestic water heating 🌞.
- Standard domestic water heating 🌞: (🌞 may operate)
- Powerful domestic water heating 🌞: (🌞 operate immediately)

3. Press **Up**▲ or **Down**▼ button to set the desired temperature.

The temperature can be set between 30°C to 70°C.



- The temperature is adjusted by 0.5°C.

Operating hot key function

URGENT DHW MODE

If you want to enjoy a leisurely bath or need a lot of warm water urgently, select the DHW hot key. When this mode is enabled, it is assured that the full capacity of the heat pump is only delivered for domestic water heating.

1. Press **DHW** Hot key.

The full capacity of the heat pump is only delivered to the DHW tank.

The booster heater is forced to operate until the temperature of DHW tank reaches the set point.



- This hot function can not be used when the DHW tank is not installed.
- If the **Power(DHW mode)** button has not been turned on, this **DHW** key does not work.
- In this DHW function mode, both space heating and floor heating are not available. The  icon is blinking for 3 seconds.
- This hot function remains available when the solar operation.
- The temperature set point is determined by user's input during urgent DHW mode. However, you can adjust the desired temperature using **Up**▲ or **Down**▼ keys.

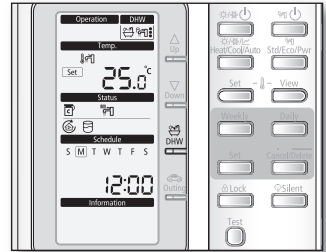

To cancel the DHW mode

1. Press **DHW** Hot key once again to exit.

The heat pump is turned on a normal operation.



By default field setting value option, this function will not be turned off automatically. If you want a hot key function for a certain amount of duration time, change the field setting value of remote controller.

OUTING MODE

If you want to take a vacation, you can use the Outing hot key. When this mode is enabled, it is assured that the heat pump maintains your house at a lower temperature to save energy cost.

1. Press **Outing** Hot key.

The heat pump delivers heat at a low temperature.

-  If the **Power(Space mode)** button has been not turned on, this key does not work.

To cancel the outing mode

1. Press **Outing** Hot key once again to exit.

The heat pump is turned on a normal operation.

-  It will return to a normal heating mode or DHW mode.

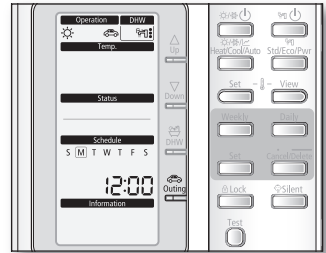

Operating advanced function

SETTING THE TIME

Your hydro unit contains a clock used to start and stop the unit automatically at a given time. You must set the time when you purchase the hydro unit or reset the main power.

1. Push the **Set** button for 3 seconds.
 - Mode : Normal operation.
 - When setting the time, you can only use **Up**△, **Down**▽, **Set**, **Cancel/Delete** button.
 - To cancel the setting, press the **Cancel/Delete** button.

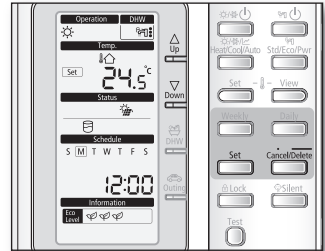

2. Set the day by pressing **Up**△ or **Down**▽ button.

The 'day' indicator will blink. Set the day and press **Set** button to save the setting.



3. Set the hour by pressing **Up**△ or **Down**▽ button.

The 'hour' indicator will blink. Set the hour and press **Set** button to save the setting.



4. Set the minute by pressing **Up**△ or **Down**▽ button.

The 'minute' indicator will blink. Set the minute and press **Set** button to save the setting.
After setting the minute, the operation returns to normal.



SETTING THE 7-DAY(WEEKLY) SCHEDULE

Set the schedules for ON/OFF timer to be repeated each week.
Maximum 7 schedules may be set for each day.

- ☞ • When using room thermostat, it is impossible to reserve
- If weekly schedule reserved 7 items is on same day, it is impossible to reserve.
In that case, When press the **Weekly** button, change the View mode of reservation.
- Setting the weekly schedule is for “Cool & Heat” Mode only.
- It is impossible to reserve several times for same day and same time.

1. Press the **Weekly** button.

The mode changes to the weekly schedule.

In this mode, you can only use **Up**△, **Down**▽, **Weekly**, **Set**, **Cancel/Delete** button.

To cancel the setting, press the **Cancel/Delete** button.

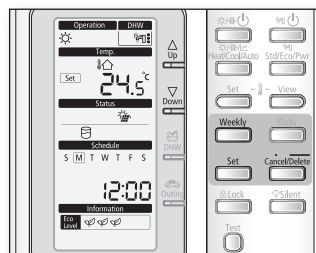

2. Set the day by pressing **Up**△ or **Down**▽ button.

The On/Off indicator will blink. Set the On/Off status and press **Set** button to save the setting.



3. Set the On/Off by pressing **Up**△ or **Down**▽ button.

The 'On/Off' indicator will blink. Set the On/Off status and press **Set** button to save the setting.



4. Set the operation mode by pressing **Up**△ or **Down**▽ button.

The 'operation indicator' will blink. Set the day and press **Set** button to save the setting.

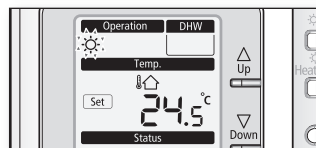

- ☞ • To set the “Off” reservation, move to the step 6.
- It is impossible to set the Auto(⌂) mode.

5. Set the temperature by pressing the **Up**△ or **Down**▽ button.

The 'temperature' will blink. Set the temperature and press **Set** button to save the setting.



☞ The setting temperature is decided according to Dip S/W #2 of remote controller.

- Dip S/W #2 On : Setting the temperature of indoor.
- Dip S/W #2 Off : Setting the temperature of water outlet.

Operating advanced function

SETTING THE 7-DAY(WEEKLY) SCHEDULE

6. Set the hour by pressing the **Up**▲ or **Down**▼ button.

The 'hour' indicator will blink. Set the hour and press **Set** button to save the setting.



7. Set the minute by pressing the **Up**▲ or **Down**▼ button.

The 'minute' indicator will blink. Set the minute and press **Set** button to save the setting.



8. Confirm the Schedule.

After step 7, all indicators are blinking except "Reservation No", "Weekly". Then press the **Set** button.

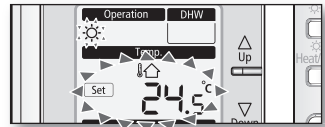

- On this step, you can only use **Set**, **Cancel/Delete** button.
- If there is a reservation on same day and time, it will not be confirmed and "Not Available" indicator will blink for 3 seconds. In this case, go back to the step 6.

Viewing the 7-day(Weekly) Schedule (On / Off) Display

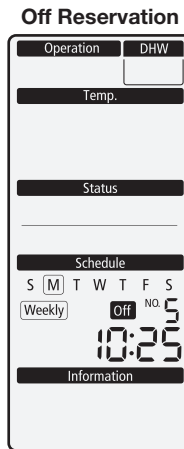

Deleting the 7-day(Weekly) schedule

1. Select the schedule from Reservation View Mode.
2. Push the **Cancel/Delete** button for 3 seconds.
3. The LCD pictures changes to the reservation mode after delete the schedule.

Operating the 7-day(Weekly) schedule

1. Operate automatically according to schedule.
2. If On schedule starts during the Urgent DHW mode, the Urgent DHW mode will change to DHW mode.
3. If Off schedule starts during the Heat/Cool/Auto mode, the operation will stop.



In the following conditions, the schedule function will not operate.

- Outing
- Tracking of communication
- Installation of room thermostat

Operating advanced function

SETTING THE DAILY SCHEDULE

Set the daily schedule to reserve On / Off timer of DHW(Eco/Std/Power) and Silent mode.
At most 15 schedules may be set for day.

- ✎ • If the field setting is for no use DHW and use other manufacturer tank, it is impossible to reserve "DHW" mode.
- If daily schedule reserved 15 schedules is on same day, it is impossible to reserve. In that case, when press the **Daily** button, change the View mode of reservation.
- It is impossible to reserve several times for the same time.

1. Press the **Daily** button.

The mode changes to the Daily schedule.

In this mode, you can only use **Up**▲, **Down**▼, **Daily**, **Set**, **Cancel/Delete** button.

To cancel the setting, press **Cancel** button.

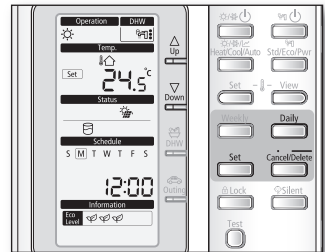

2. Set the On/Off by pressing **Up**▲, **Down**▼ button.

The 'On/Off' indicator will blink. Set the On/Off status and press **Set** button to save the setting.

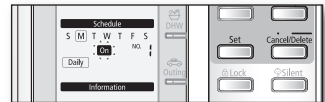

3. Set the operation mode by pressing **Up**▲ or **Down**▼ button.

The 'operation indicator' will blink. Set the operation mode and press **Set** button to save the setting.

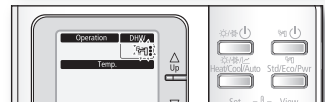

- ✎ • When using other company DHW Tank or setting no use DHW mode, the reservation mode is fixed to "Silent" mode.
- When setting use DHW mode, the mode is changed as followings with **Up**▲ or **Down**▼ button.
 - "On" Mode ; ❶ → ❷ → ❸(❹) → ❺ → ❶.
 - Pwr mode (❸) is selected in "Booster heater On"
 - "Off" Mode ; ❶ → ❷ → ❸:

- Set the hour by pressing the **Up**▲ or **Down**▼ button.

The 'hour' indicator will blink. Set the hour and press **Set** button to save the setting.

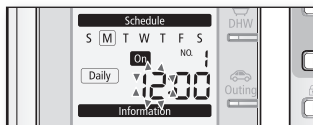

- Set the minute by pressing the **Up**▲ or **Down**▼ button.

The 'minute' indicator will blink. Set the minute and press **Set** button to save the setting.



- Confirm the Schedule.

After step 5, all indicators are blinking except "Reservation No", "Daily". Then press **Set** button.

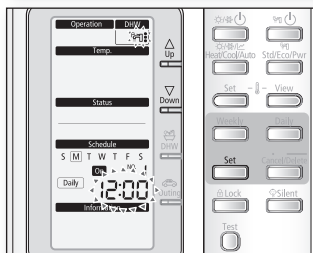

- On this step, you can only use **Set** or **Cancel/Delete** button.
- If there is a reservation on same day and time, it will not be confirmed and "Not Available" indicator will blink for 3 seconds. In this case, go back to the step 4.

Viewing the Daily Schedule (On / Off) Display

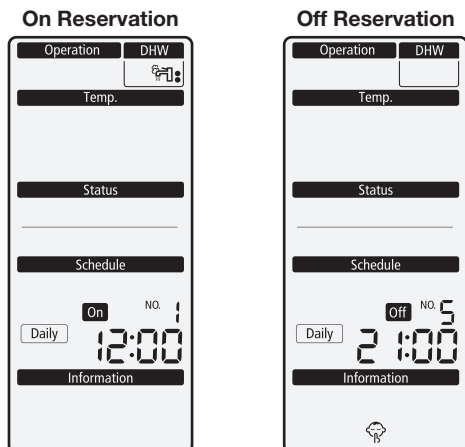

Operating advanced function

SETTING THE DAILY SCHEDULE

Deleting the daily schedule

1. Select the schedule from Reservation View Mode.
2. Push the **Cancel/Delete** button for 3 seconds.
3. The LCD pictures change to the reservation mode after deleting the schedule.

Operating the daily schedule

1. Operate automatically according to schedule.
2. If On schedule starts during the Urgent DHW mode, the Urgent DHW mode will be turned off.



In the following conditions, the schedule function will not operate.

- Outing
- Tracking of communication
- Installation of room thermostat
- If the field setting is set for without DHW or another manufacturers tank is used, its not possible to reserve DHW mode.
- If the field setting is set for not using the booster heater, its not possible to reserve Pwr DHW mode.

Setting the Field Setting Value of wired remote controller

Field setting mode is to adjust specific functions in accordance with customer's demands.

Field setting mode is easy-to-access and programmable by the wired remote controller of hydro unit.

Field setting values are consisted of 4 digits.

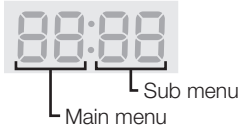

Adjusting filed setting values is available in the unit operation.

Default field setting value and range is on 32~34 pages.

1. Press the **Test** button for 5 seconds.

The mode changes to the field setting.

In this mode, you can only use **Up**▲, **Down**▼, **Set**, **Cancel/Delete** button.

To cancel the setting, press **Cancel/Delete** button.

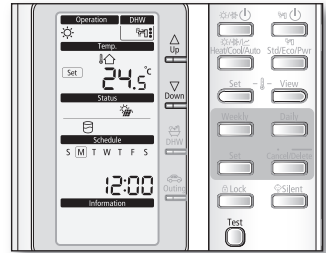

2. Set the Main Menu by pressing **Up**▲ or **Down**▼ button.

The "Number" will blink. Set the Main menu and press **Set** button to save the setting.

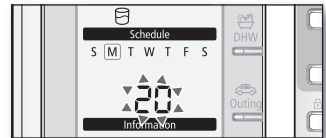

3. Set the Sub Menu by pressing **Up**▲ or **Down**▼ button.

The "Number" will blink. Set the Sub menu by pressing **Up**▲ or **Down**▼ button. Then press **Set** button to save the setting.

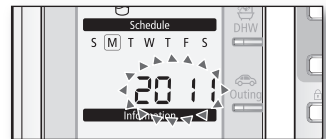

4. Set the Operation Range(Field Setting) by pressing **Up**▲ or **Down**▼ button.

The digits in "Temp" category will blink. Set the Field Setting Value by pressing **Up**▲ or **Down**▼ button. Then press **Set** button to save the settings. After 5 seconds, The LCD shall go back to initial display. If no input for setting value changes, the LCD shall go back to initial display after 30 seconds.

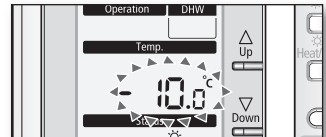

Operating advanced function

FIELD SETTING MODE

Field Setting Value(FSV) Table

- Code 10** : Upper and lower temperature limits of each operation mode of wired remote controller
Heating(Water Out, Room), Cooling(Water Out, Room), DHW(Tank)
- Code 20** : Water law design and external room thermostat
Heating(2 WL's for floor & FCU), Cooling(2 WL's for floor & FCU), WL & Thermostat types

Field Setting Value									
Main Menu & Code	Sub Menu Function	Description	Sub Code	Default	Min	Max	Step	Unit	
Remote Controller Setting Range Code 10**	Water Out Temp for Cooling	Max	**11	25	18	25	1	°C	
		Min	**12	16	5	18	1	°C	
	Room Temp for Cooling	Max	**21	30	24	30	1	°C	
		Min	**22	18	18	22	1	°C	
	Water Out Temp for Heating	Max	**31	55	37	55	1	°C	
		Min	**32	25	15	37	1	°C	
	Room Temp for heating	Max	**41	30	24	30	1	°C	
		Min	**42	16	16	22	1	°C	
	DHW Tank Temp	Max	**51	50	50	70	1	°C	
		Min	**52	40	30	40	1	°C	
	Water Law Code 20**	Outdoor Temp for Water Law (Heating)	Point ①	**11	-10	-20	5	1	°C
			Point ②	**12	15	10	20	1	°C
Water Out Temp for WL1 Heating (WL1-Floor)		Point ①	**21	40	40	55	1	°C	
		Point ②	**22	25	17	37	1	°C	
Water Out Temp for WL2 Heating (WL2-Fan Coil Unit)		Point ①	**31	50	40	55	1	°C	
		Point ②	**32	35	17	37	1	°C	
Heating Water Law for Auto Mode		WL Type	**41	1(WL1)	1	2(WL2)	-	-	
Outdoor Temp for Water Law (Cooling)		Point ①	**51	30	25	35	1	°C	
		Point ②	**52	40	35	45	1	°C	
Water Out Temp for WL1 Cooling (WL1-Floor)		Point ①	**61	25	18	25	1	°C	
		Point ②	**62	18	5	18	1	°C	
Water Out Temp for WL2 Cooling (WL2-Fan Coil Unit)		Point ①	**71	18	18	25	1	°C	
		Point ②	**72	5	5	18	1	°C	
Cooling Water Law for Auto Mode		WL Type	**81	1(WL1)	1	2(WL2)	-	-	
External Thermostat Application		#1(Floor)	**91	0(No)	0	1(Yes)	-	-	
		#2(FCU)	**92	0(No)	0	1(Yes)	-	-	

- Code 30** : User's options for domestic hot water(DHW) tank heating
 - 3011 : Application of DHW tank in user's system
 - 302* : Heat pump variables for tank temp. control and combination with booster heater
 - 303* : Booster heater variables for combination with heat pump
 - 304* : Periodical disinfection heating of water tank
 - 305* : Off timer for power DHW mode by hot key of wired remote controller
 - 3061 : Combination of external field solar panel for with heat pump for DHW heating

Field Setting Value								
Main Menu & Code	Sub Menu Function	Description	Sub Code	Default	Min	Max	Step	Unit
DHW Code 30**	Domestic Hot Water Tank	Application	**11	0(No)	0	1(Yes)	-	-
	Heat Pump	Max Temp	**21	50	45	55	1	°C
		Stop	**22	2	2	10	1	°C
		Start	**23	5	1	20	1	°C
		Min Operation	**24	5	0	20	1	min
		Max Operation	**25	30	5	95	5	min
	Booster Heater	Interval	**26	3	0	10	0.5	hour
		Application	**31	1(On)	0(OFF)	1	-	-
		Delay Time	**32	20	20	95	5	min
		Overshoot	**33	0	0	4	1	°C
	Disinfection	Compensation Temp	**34	10	0	20	1	°C
		Application	**41	1(On)	0(OFF)	1	-	-
		Interval	**42	Fri	Mon	Sun	1(All)	day
		Start Time	**43	23	0	23	1	o'clock
		Target Temp	**44	70	40	70	5	°C
	Power DHW by User Input	Duration	**45	10	5	60	5	min
		Timer OFF Function	**51	0(Off)	0	1(On)	-	-
	Solar Panel	Timer Duration	**52	60	30	300	10	min
		H/P Combination	**61	0	0	1(Yes)	-	-

Operating advanced function

FIELD SETTING MODE

Field Setting Value(FSV) Table

- Code 40** : User's options for heating devices including internal backup heater and external boiler
 - 401* : Space/DHW heating priority and control variables
 - 402* : Backup/Booster heater priority and control variables
 - 403* : Additional backup boiler operating variables
- Code 50** : User's options for extra functions
 - 501* : New target temperatures of each mode by "Outgoing" hot key of remote controller
 - 5021 : Temperature difference between before & after values in "Economic" DHW mode
 - 503* : Time-division multi(TDM) variables for combining operation b/w A2A and A2W

Field Setting Value								
Main Menu & Code	Sub Menu Function	Description	Sub Code	Default	Min	Max	Step	Unit
Heating Code 40**	Heat Pump	Heating/DHW Priority	**11	0(DHW)	0	1(Heating)	-	-
		Outdoor Temp for Priority	**12	0	-15	20	1	°C
		Heating Off	**13	25	14	35	1	°C
		Overshoot	**14	2	1	4	1	°C
	Backup Heater	Application	**21	1(On)	0(Off)	1	-	-
		BUH/BSH Priority	**22	0(Both)	0	2(BSH)	1	-
		For back-up use only	**23	1(On)	0(Off)	1	-	-
		Threshold Temp	**24	0	-15	35	1	°C
	Backup Boiler	Application	**31	0(No)	0	1(Yes)	-	-
		Boiler Priority	**32	0(Off)	0	1(On)	-	-
		Threshold Temp	**33	-15	-20	5	1	°C
	Others Code 50**	Outing	Water Out Temp for Cooling	**11	25	5	25	1
Room Temp for Cooling			**12	30	18	30	1	°C
Water Out Temp for Heating			**13	25	15	55	1	°C
Room Temp for Heating			**14	16	16	30	1	°C
Auto Cooling WL1 Temp			**15	25	5	25	1	°C
Auto Cooling WL2 Temp			**16	25	5	25	1	°C
Auto Heating WL1 Temp			**17	15	15	55	1	°C
Auto Heating WL2 Temp			**18	15	15	55	1	°C
Target Tank Temp		**19	30	30	70	1	°C	
DHW Saving Mode		Temp Difference	**21	5	0	40	1	°C
TDM Variable		A2A Max Operation Time	**31	30	5	60	5	min
	A2W Min Operation Time	**32	3	0	10	1	min	

Remote Controller Setting Range : Code 10**

Field Setting Value								
Main Menu & Code	Sub Menu Function	Description	Sub Code	Default	Min	Max	Step	Unit
Remote Controller Setting Range	Water Out Temp for Cooling	Max	**11	25	18	25	1	°C
		Min	**12	16	5	18	1	°C
	Room Temp for Cooling	Max	**21	30	24	30	1	°C
		Min	**22	18	18	22	1	°C
Code 10**	Water Out Temp for Heating	Max	**31	55	37	55	1	°C
		Min	**32	25	15	37	1	°C
	Room Temp for heating	Max	**41	30	24	30	1	°C
		Min	**42	16	16	22	1	°C
	DHW Tank Temp	Max	**51	50	50	70	1	°C
		Min	**52	40	30	40	1	°C

Space Cooling

- Target water outlet temperature : Upper limit(#1011, Default 25°C, Range : 18 ~ 25°C), Lower limit(#1012, Default 16°C, Range : 5 ~ 18°C)
- With this default FSV settings, user can change the target water outlet temperature within the range of 5 ~ 25°C for cooling
- Target room temperature : Upper limit(#1021, Default 30°C, Range : 24 ~ 30°C), Lower limit(#1022, Default 18°C, Range : 18 ~ 22°C)
- With this default FSV settings, user can change the target room temperature within the range of 18 ~ 30°C for cooling.



- The #1 DIP switch in the wired remote controller should be set to "OFF"(Default) for cooling operation of heat pump.
- The #2 DIP switch in the wired remote controller should be set to "OFF"(Default) to control the water outlet temperature.
- The #2 DIP switch in the wired remote controller should be set to "ON" to control the room temperature.
- The #3 DIP switch in the wired remote controller should be set to "OFF"(Default) to control the air sensor in remote controller.
- The #3 DIP switch in the wired remote controller should be set to "ON" to control the external air sensor.

Space Heating

- Target water outlet temperature : Upper limit(#1031, Default 55°C, Range : 37 ~ 55°C), Lower limit(#1032, Default 25°C, Range : 15 ~ 37°C)
- With this default FSV settings, user can change the target water outlet temperature within the range of 25 ~ 55°C for heating.
- Target room temperature : Upper limit(#1041, Default 30°C, Range : 24 ~ 30°C), Lower limit(#1042, Default 16°C, Range : 16 ~ 22°C)
- With this default FSV settings, user can change the target room temperature within the range of 16 ~ 30°C for heating.



- The #2 DIP switch in the wired remote controller should be set to "OFF"(Default) to control the water outlet temperature.
- The #2 DIP switch in the wired remote controller should be set to "ON" to control the room temperature.

DHW Heating

- Target DHW tank temperature : Upper limit(#1051, Default 50°C, Range : 50 ~ 80°C), Lower limit(#1052, Default 40°C, Range : 30 ~ 40°C)
- With this default FSV settings, user can change the target tank temperature within the range of 40 ~ 50°C for DHW heating.



- The FSV #3011 in the wired remote controller should be set to "1(Yes)" to use DHW function.

Operating advanced function

FIELD SETTING MODE

Water Law & Room Thermostat : Code 20**

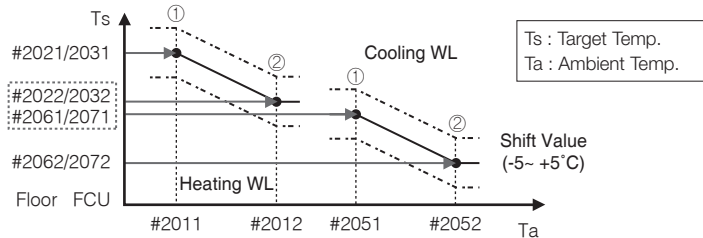

Field Setting Value								
Main Menu & Code	Sub Menu Function	Description	Sub Code	Default	Min	Max	Step	Unit
Water Law Code 20**	Outdoor Temp for Water Law (Heating)	Point ①	**11	-10	-20	5	1	°C
		Point ②	**12	15	10	20	1	°C
	Water Out Temp for WL1 Heating (WL1-Floor)	Point ①	**21	40	40	55	1	°C
		Point ②	**22	25	17	37	1	°C
	Water Out Temp for WL2 Heating (WL2-Fan Coil Unit)	Point ①	**31	50	40	55	1	°C
		Point ②	**32	35	17	37	1	°C
	Heating Water Law for Auto Mode	WL Type	**41	1(WL1)	1	2(WL2)	-	-
	Outdoor Temp for Water Law (Cooling)	Point ①	**51	30	25	35	1	°C
		Point ②	**52	40	35	45	1	°C
	Water Out Temp for WL1 Cooling (WL1-Floor)	Point ①	**61	25	18	25	1	°C
		Point ②	**62	18	5	18	1	°C
	Water Out Temp for WL2 Cooling (WL2-Fan Coil Unit)	Point ①	**71	18	18	25	1	°C
		Point ②	**72	5	5	18	1	°C
	Cooling Water Law for Auto Mode	WL Type	**81	1(WL1)	1	2(WL2)	-	-
	External Thermostat Application	#1(Floor)	**91	0(No)	0	1(Yes)	-	-
		#2(FCU)	**92	0(No)	0	1(Yes)	-	-

Water Law for Heating

- Outdoor air temperature range : Lower limit ①(#2011, Default -10°C, Range : -20 ~ 5°C), Upper limit ②(#2012, Default 15°C, Range : 10 ~ 20°C)
 - With this default settings, the water outlet temperature by heating water law can be changed within the outdoor temperature range of -10 ~ 15°C.
- Water out temperature range for floor/FCU applications respectively : Upper limit ①(#2021/2031, Default 40/50°C, Range : 40 ~ 55°C), Lower limit ②(#2022/2032, Default 25/35°C, Range : 17 ~ 37°C)
 - With this default settings, the water outlet temperature by heating water law can be changed within the range of 25/35 ~ 40/50°C.
- Type of water law for according to heating devices(floor/FCU) : #2041(Default "1"(WL1 for floor)), "2"(WL2 for FCU or radiator)



- The #2 DIP switch in the wired remote controller should be set to "OFF"(Default) to control the water outlet temperature.
- The operation mode of the wired remote controller should be set to "AUTO"(AUTO) to use the weather dependent water law scheme.

Water Law for Cooling

- Outdoor air temperature range : Lower limit ①(#2051, Default 30°C, Range : 25 ~ 35°C), Upper limit ②(#2052, Default 40°C, Range : 35 ~ 45°C)
 - With this default settings, the water outlet temperature by cooling water law can be changed within the outdoor temperature range of 30 ~ 40°C.
- Water out temperature range for floor/FCU applications respectively : Upper limit ①(#2061/2071, Default 25/18°C, Range : 18 ~ 25°C), Lower limit ②(#2062/2072, Default 18/5°C, Range : 5 ~ 18°C)
 - With this default settings, the water outlet temperature by cooling water law can be changed within the range of 18/5 ~ 25/18°C.
- Type of water law for according to cooling devices(floor/FCU) : #2081(Default "1"(WL1 for floor), "2"(WL2 for FCU or radiator)
 - The #1 DIP switch in the wired remote controller should be set to "OFF"(Default) for cooling operation of heat pump.
 - The #2 DIP switch in the wired remote controller should be set to "OFF"(Default) to control the water outlet temperature.
 - Only heating WL operation could be used through "Auto" mode of wired remote controller.



External Room Thermostat (Field Option)

- Terminal #1(#2091, Default "0" for no usage), #2(#2092, Default "0" for no usage)
 - To use wired remote controller for heating/cooling operation, both of the above settings should be set to "0" simultaneously. If not, thermostat controls system.
 - Types of water law used by room thermostat operation will follow the FSV settings defined in #2041(heating) and #2081(cooling) respectively.
 - During the thermostat operation, the user has the possibility to shift up or down the target water temperature within the range of -5 ~ +5°C.

Operating advanced function

FIELD SETTING MODE

DHW Heating : Code 30**

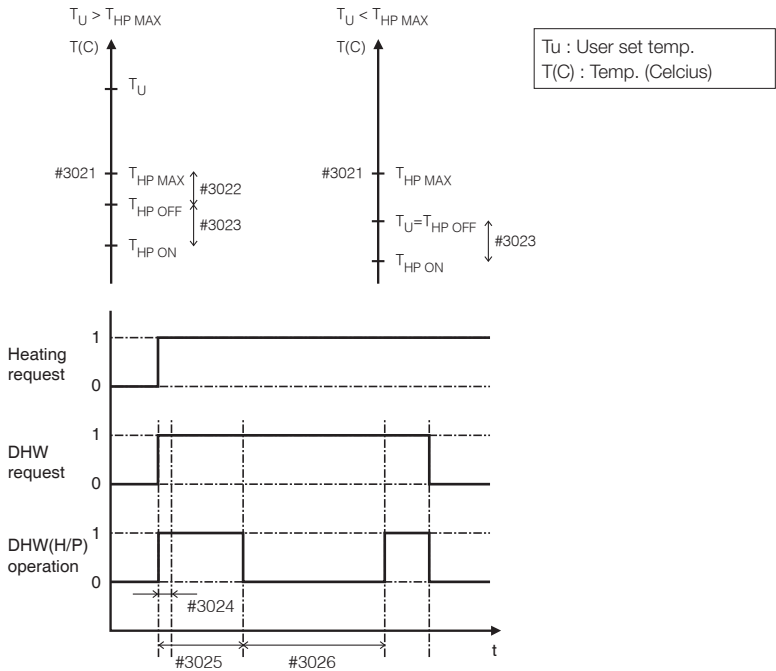

Field Setting Value								
Main Menu & Code	Sub Menu Function	Description	Sub Code	Default	Min	Max	Step	Unit
DHW Code 30**	Domestic Hot Water Tank	Application	**11	0(No)	0	1(Yes)	-	-
	Heat Pump	Max Temp	**21	50	45	55	1	°C
		Stop	**22	2	2	10	1	°C
		Start	**23	5	1	20	1	°C
		Min Operation	**24	5	0	20	1	min
		Max Operation	**25	30	5	95	5	min
		Interval	**26	3	0	10	0.5	hour
	Booster Heater	Application	**31	1(On)	0(Off)	1	-	-
		Delay Time	**32	20	20	95	5	min
		Overshoot	**33	0	0	4	1	°C
		Compensation Temp	**34	10	0	20	1	°C
	Disinfection	Application	**41	1(On)	0(Off)	1	-	-
		Interval	**42	Fri	Mon	Sun	1(All)	day
		Start Time	**43	23	0	23	1	o'clock
		Target Temp	**44	70	40	70	5	°C
		Duration	**45	10	5	60	5	min
	Power DHW by User Input	Timer OFF Function	**51	0(Off)	0	1	-	-
		Timer Duration	**52	60	30	300	10	min
	Solar Panel	H/P Combination	**61	0(No)	0(No)	1(Yes)	-	-

DHW Application

The FSV #3011 in the wired remote controller should be set to "1(Yes)" to use DHW function.

Heat Pump Variables for Controlling DHW Tank

- Maximum DHW tank temperature with R410A(refrigerant) heat pump operation :
FSV #3021, Default 50°C, Range : 45 ~ 55°C.
- Temperature difference determining the heat pump OFF temperature :
FSV #3022, Default 2°C, Range : 2 ~ 10°C.
- Temperature difference determining the heat pump ON temperature :
FSV #3023, Default 5°C, Range : 1 ~ 20°C.
- DHW heating mode timer : If there is simultaneous requests of space heating/cooling and DHW heating, this mode timer will toggle operation modes.
 - FSV #3024(minimum DHW operating time, Default 5 min., Range 0 ~ 20 min.),
#3025(maximum DHW time, Default 30 min., Range 5 ~ 95 min.), #3026(time interval between two consecutive DHW mode operations, Default 3 hour, Range 0 ~ 10 hour)



The FSV #4011 for DHW priority should be set to "0(DHW)"(Default) for the mode timer action as mentioned above.

If not, the space heating mode by heat pump has a priority over the DHW heating mode under the specified low outdoor temperature(#4012).

Operating advanced function

FIELD SETTING MODE

DHW Heating : Code 30**

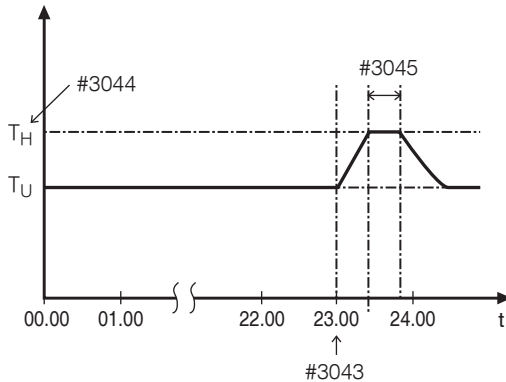
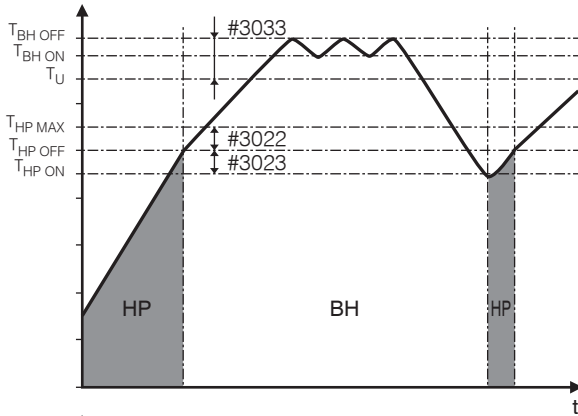
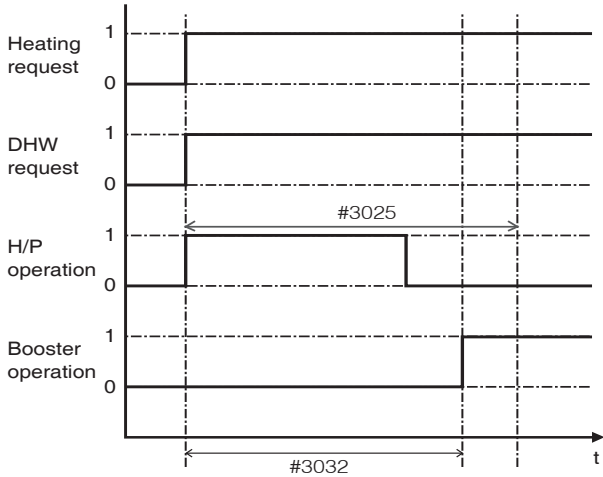

Booster Heater Variables for Controlling DHW Tank

- The FSV #3031 should be set to “1(On)”(Default) to use booster heater as an additional heat source for DHW tank.
- Booster heater startup delay timer : In case of DHW request, this timer will delay the operation of booster heater compared to heat pump.
 - FSV #3032(Default 20 min., Range 20 ~ 95 min.), In “Power” DHW mode, the delay timer will be neglected, and the booster starts immediately.
 - In “Economic” DHW mode, the DHW heating will be conducted only with heat pump.
 - #3032 should be smaller than the maximum H/P time(#3025). If the delay time is set too high, it might take very long time for DHW heating.
- Temperature difference determining the booster heater OFF temperature($T_{BH\ OFF} = T_u + \#3033$) : FSV #3033, Default 0°C, Range : 0 ~ 4°C.
 - Temperature difference determining the booster heater ON temperature($T_{BH\ ON} = T_{BH\ OFF} - 2$)
- DHW compensation temperature in case of space heating/cooling priority : FSV #3034 will be explained in next page.



The FSV #4022 for booster heater priority should be set to “0(both)”(Default) or “2”(booster) to use booster heater.

If not(backup heater priority), the booster heater can be operated in case of no backup heater demand.

Disinfection Function

- The FSV #3041 should be set to “1(On)”(Default) to use disinfection function.
 - Scheduling : Day(#3042, Default “Friday”), starting time(#3043, Default “23:00”), target tank temp. (#3044, Default “70°C”), duration(#3045, Default 10 min.)



Disinfection function can be performed only with Samsung’s DHW tank installation.

Urgent DHW by User’s Input (Hot Key of Wired Remote Controller)

- By default setting(#3061, Default “0(Off)”, Urgent DHW heating will not be turned off automatically before user’s additional key input. If you want to quit urgent DHW function after a certain amount of duration time(#3052, Default “60 min.”, Range 30 ~ 300 min.), change the FSV #3051 to “1(On)”.

Additional Solar Panel Installation for DHW with Heat Pump (Field Option)

- By default setting(#3051, Default “1(Yes)”, the DHW heating by solar panel has a priority over the heat pump operation in case of solar panel installation.

Operating advanced function

FIELD SETTING MODE

Space Heating : Code 40**

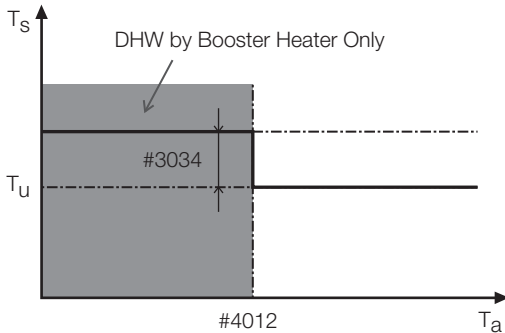

Field Setting Value								
Main Menu & Code	Sub Menu Function	Description	Sub Code	Default	Min	Max	Step	Unit
Heating Code 40**	Heat Pump	Heating/DHW Priority	**11	0(DHW)	0	1(Heating)	-	-
		Outdoor Temp for Priority	**12	0	-15	20	1	°C
		Heating Off	**13	25	14	35	1	°C
		Overshoot	**14	2	1	4	1	°C
	Backup Heater	Application	**21	1(On)	0(Off)	1	-	-
		BUH/BSH Priority	**22	0(Both)	0	2(BSH)	1	-
		For back-up use only	**23	1(On)	0(Off)	1	-	-
		Threshold Temp	**24	0	-15	35	1	°C
	Backup Boiler	Application	**31	0(No)	0	1(Yes)	-	-
		Boiler Priority	**32	0(Off)	0	1(On)	-	-
		Threshold Temp	**33	-15	-20	5	1	°C

Heat Pump Variables for Space Heating

- FSV #4011 for DHW priority is set to "0(DHW)"(Default) for the first time. In case of "1(Heating)", the space heating by heat pump has a priority over the DHW heating by heat pump under the low outdoor temperature condition(#4012).
- DHW compensation temperature in case of space heating priority:
At low outdoor temperature, the target temperature of DHW tank will be increased by the temperature difference defined in FSV #3034 to compensate the relatively cold water stored in DHW tank. In this case, the only heat source for DHW tank would be booster heater inside tank, so the lower part of water stored in tank could be cold due to "No operation of heat pump". The corrected (higher) set point will make sure that the total heat capacity of the water in the tank remains approximately unchanged, by compensating for the colder bottom water layer of the tank (because the heat exchanger coil is not operational) with a warmer top layer.
- Space heating off temperature(FSV #4013, Default "25°C", Range 14 ~ 35°C):
At high outdoor temperature above this value, the space heating will be turned off, to avoid overheating.
- Overshoot temperature(FSV #4014, Default "2°C", Range 1 ~ 4°C): N/A yet

Backup Heater Variables for Space Heating

- The FSV #4021 should be set to "1(On)"(Default) to use 2-stage electric backup heater in hydro unit as an additional heat source.
- To compensate the lowered heat pump heating performance under very cold weather conditions, the FSV #4023 should be set to "1(On)"(Default).
 - The threshold temperature to use backup heater for cold weather compensation: FSV #4024, Default "0°C", Range -15 ~ 35°C
 - Above the threshold temperature, the backup heater usage is restricted to save energy consumption.
- The FSV #4022 for backup heater priority should be set to "0(both)"(Default) or "1"(backup) to use backup heater. If not(booster heater priority), the backup heater can be operated in case of no booster heater demand.



To use both heaters together at the same time, please check the capacity of the power circuit breaker of your house before.

External Backup Boiler for Space Heating (Field Option)

- The FSV #4031 should be set to "1(Yes)" to use a backup boiler as an additional heat source. By default option("0(No)), no installation.
- Under the installation of backup boiler in your house, you can freely choose the boiler priority(FSV #4032, Default "0(Off)").
- To compensate the lowered heat pump heating performance under very cold weather conditions, the backup boiler will be operating instead of heat pump under the threshold temperature(FSV #4033, Default "-15°C", Range -20 ~ 5°C).

Operating advanced function

FIELD SETTING MODE

Others : Code 50**

		Field Setting Value						
Main Menu & Code	Sub Menu Function	Description	Sub Code	Default	Min	Max	Step	Unit
Others Code 50**	Outing	Water Out Temp for Cooling	**11	25	5	25	1	°C
		Room Temp for Cooling	**12	30	18	30	1	°C
		Water Out Temp for Heating	**13	25	15	55	1	°C
		Room Temp for Heating	**14	16	16	30	1	°C
		Auto Cooling WL1 Temp	**15	25	5	25	1	°C
		Auto Cooling WL2 Temp	**16	25	5	25	1	
		Auto Heating WL1 Temp	**17	15	15	55	1	°C
		Auto Heating WL2 Temp	**18	15	15	55	1	°C
		Target Tank Temp	**19	30	30	70	1	°C
	DHW Saving Mode	Temp Difference	**21	5	0	40	1	°C
TDM Variable	A2A Max Operation Time	**31	30	5	60	5	min	
	A2W Min Operation Time	**32	3	0	10	1	min	

Outing Mode (Hot Key of Wired Remote Controller)

- All the target temperatures(both water outlet and room) for space heating/cooling/ auto(water-law) modes and the target tank temperature for DHW heating mode will be changed to the values defined in the table above to save energy consumption during the vacancy of house.



With the lowered target temperatures(FSV #5011 ~ #5019), the system will be operated normally.

Economic DHW Heating

- Which is heat pump only, saving energy consumption. A target temperature of DHW shall be lowered as much as Users set with field setting values stored in wired remote controller.
 - New target DHW tank temperature will be the value subtracted the difference(#5021) from the present user's setting.

TDM(Time-Division Multi) Variables

- Under the installation of both A2A(Air-To-Air type air conditioner) and A2W(Air-To-Water type hydro unit) at the same time, our outdoor machine can supply its full capacity to the operating indoor machines(including A2A and A2W). If there are simultaneous operating demands from many A2A machines with A2W, the priority of controlling the outdoor machine(ex: compressor frequency) will be given to A2A, because of their fast response for use's comfort. Only the remaining capacity of outdoor machine will be given to A2W during A2A's normal operation. In this case, it might take very long time for A2W heating, so the outdoor machine will alternate the controlling priorities between A2A and A2W with time basis.
- A2A maximum operation time: FSV #5031(Default "30 min.", Range 5 ~ 60 min.), After this maximum time, the outdoor machine will operate only for A2W to speed up the A2W's heating/cooling performance, even though there are A2A's continuous operation demands.
- A2W minimum operation time: FSV #5032(Default "3 min.", Range 0 ~ 10 min.), in this minimum time, the outdoor machine will operate only for A2W, even though there are no more A2W's continuous operation demands.

Appendix

TEMPERATURE TABLE

Available operation range

Mode	Target temperature		Display		Setting range		Current display	Setting method	Control method
			Set	View	Default	Available			
Cooling	Leaving water		O	O	16~25°C	<ul style="list-style-type: none"> Min : 5~18°C Max : 18~25°C 	-50~94°C	Up/Down	Hydro or Indoor unit
	Room		O	O	18~30°C	<ul style="list-style-type: none"> Min : 18~22°C Max : 24~30°C 	-50~94°C	Up/Down	Indoor unit
Heating	Leaving water		O	O	25~55°C	<ul style="list-style-type: none"> Min : 15~37°C Max : 37~55°C 	-50~94°C	Up/Down	Hydro or Indoor unit
	Room		O	O	16~30°C	<ul style="list-style-type: none"> Min : 16~22°C Max : 24~30°C 	-50~94°C	Up/Down	Indoor unit
Water Law	Cooling	Outdoor	X	X	30~40°C	<ul style="list-style-type: none"> Min : 25~35°C Max : 35~45°C 	-50~94°C	Field Setting Mode SET/VIEW mode	Hydro unit or Thermostat (Th-1 : Floor, Th-2 : FCU)
		Leaving water (WL1-Floor)	X	X	25~18°C	<ul style="list-style-type: none"> Min : 18~25°C Max : 5~18°C 	-50~94°C		
		Leaving water (WL2-FCU)	X	X	18~5°C	<ul style="list-style-type: none"> Min : 18~25°C Max : 5~18°C 	-50~94°C		
	Heating	Outdoor	X	X	-10~15°C	<ul style="list-style-type: none"> Min : -20~5°C Max : 10~20°C 	-50~94°C		
		Leaving water (WL1-Floor)	X	X	40~25°C	<ul style="list-style-type: none"> Min : 40~55°C Max : 17~37°C 	-50~94°C		
		Leaving water (WL2-FCU)	X	X	50~35°C	<ul style="list-style-type: none"> Min : 40~55°C Max : 17~37°C 	-50~94°C		
	Temperature Shifting		O	X	-5~5°C	Default	-		
DHW	DHW tank		O	O	40~50°C	<ul style="list-style-type: none"> Min : 30~40°C Max : 50~65°C 	-50~94°C	Up/Down	Hydro unit
Outdoor temperature			X	O	-	-	-50~94°C	-	

DIP SWITCH SETTING

S/W	OFF (Default)	ON
S/W #1	Heating and Cooling	Heating only
S/W #2	Target temp : Water outlet Temp.	Target temp : Indoor air Temp.
S/W #3	Air sensor in remote controller	External air sensor
S/W #4	No Use	No Use
S/W #5	No Use	No Use
S/W #6	No Use	No Use
S/W #7	No Use	No Use
S/W #8	No Use	No Use

MAINTAINING THE UNIT

Maintenance activities

- In order to ensure optimal availability of the unit, a number of checks and inspections on the unit and the field wiring have to be carried out at regular intervals, preferably yearly. This maintenance should be carried out by SAMSUNG local technician. Besides keeping the remote controller clean by means of a soft damp cloth, no maintenance is required by the operator.



During longer periods of standstill, e.g. during summer with a heating only application, it is very important NOT TO SWITCH OFF THE POWER SUPPLY towards the unit.

Switching off the power supply stops the automatic repetitive movement of the motor in order to prevent it from getting jammed.

This product contains fluorinated greenhouse gases covered by the Kyoto Protocol.

Refrigerant type: R410A

GWP(1) value: 1975 (GWP = global warming potential)

- Periodical inspections for refrigerant leaks may be required depending on European or local legislation. Please contact your local dealer for more information.

TROUBLESHOOTING TIPS

If the unit has some problem to work properly, the LED on hydro unit will flash and some error codes will be displayed on the controller.

The following table described the explanation of error codes on the LCD display.

Thermistor

- Check its resistance. 10kohm @ 24°C(Hydro unit), 220kohm@24°C(DHW Tank, Solar)
- Check its location as shown at the diagram.
- Check its contact status with pipe.
- Final solution is to change parts.

Display	Explanation
E122	EVA Inlet thermistor SHORT or OPEN
E123	EVA Outlet thermistor SHORT or OPEN
E53	Wired remote controller thermistor SHORT or OPEN
E54	FRAM Read/Write Error(Wired remote controller data error)
E01	Water Inlet thermistor SHORT or OPEN
E02	Water Outlet thermistor SHORT or OPEN
E03	PHE thermistor SHORT or OPEN
E04	Water TANK thermistor SHORT or OPEN

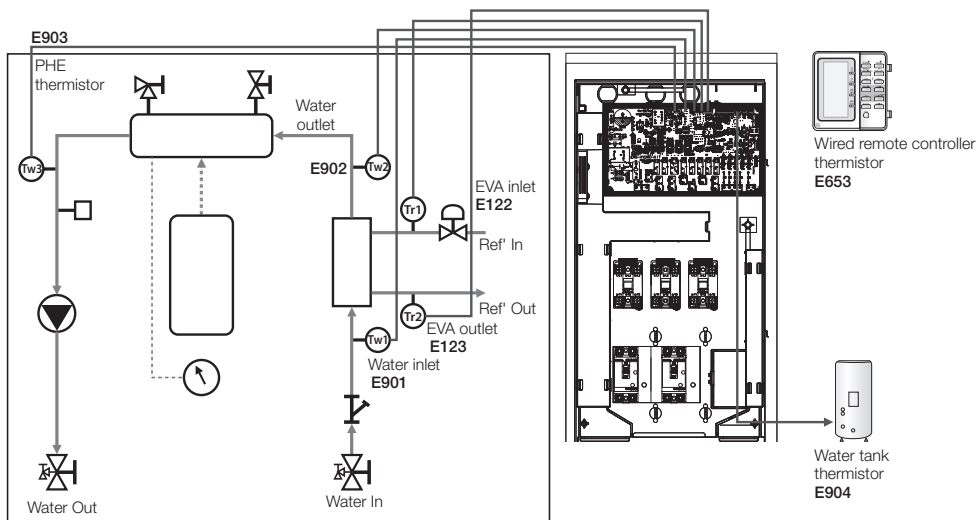

Appendix

TROUBLESHOOTING

Communication

Display	Explanation
<i>E01</i>	Abnormal communication B/W Wired remote controller & Hydro unit
<i>E04</i>	Communication tracking error B/W Wired remote controller & Hydro unit
<i>E54</i>	FRAM Read/Write Error(Wired remote controller data error)

E601, E604

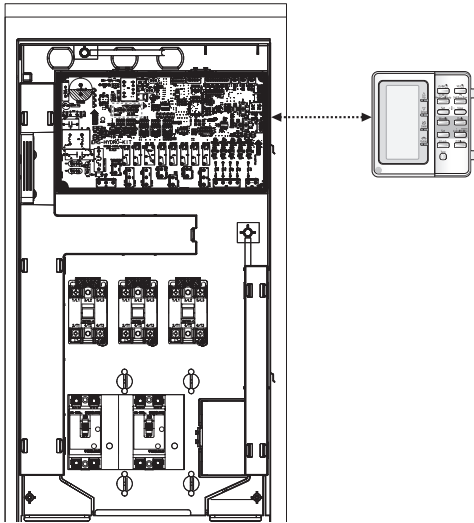

E654

- Wrong data transmit B/W micom & IC07(eeprom)

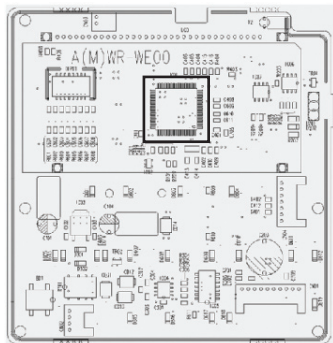

Water pump & Flow S/W

Display	Explanation
911	Flow S/W OFF error (In case of flow S/W OFF in 10s during water pump signal is ON)
912	Flow S/W OFF error (In case of flow S/W ON in 10s during water pump signal is OFF)

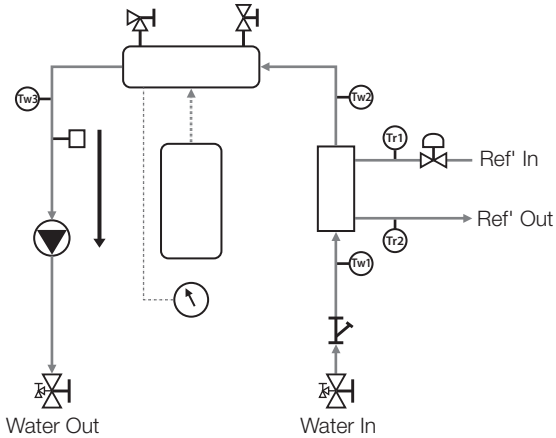

E911

- Water pump OFF (Flow S/W on)

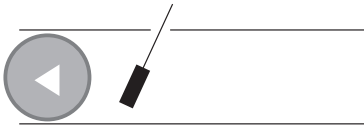

E912

- Water pump ON (Flow S/W off)

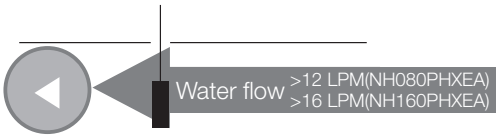

- Water pump ON (Flow S/W off) : NOT enough water flow

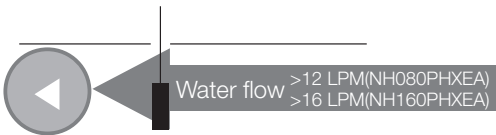

DISPOSAL REQUIREMENTS

- Dismantling of the unit, treatment of the refrigerant, of oil and of other parts must be done in accordance with relevant local and national legislation.
- Your product is indicated with this symbol. This means that electrical and electronic products shall not be mixed with unsorted household waste.
- Do not try to dismantle the system yourself: the dismantling of the system, treatment of the refrigerant, of oil and other parts must be done by a qualified installer in accordance with relevant local and national legislation.
- Units must be treated at a specialized treatment facility for re-use, recycling and recovery. By ensuring this product is disposed off correctly, you will help to prevent potential negative consequences for the environment and human health. Please contact the installer or local authority for more information.



Memo

Memo

Memo



Free Manuals Download Website

<http://myh66.com>

<http://usermanuals.us>

<http://www.somanuals.com>

<http://www.4manuals.cc>

<http://www.manual-lib.com>

<http://www.404manual.com>

<http://www.luxmanual.com>

<http://aubethermostatmanual.com>

Golf course search by state

<http://golfingnear.com>

Email search by domain

<http://emailbydomain.com>

Auto manuals search

<http://auto.somanuals.com>

TV manuals search

<http://tv.somanuals.com>