



HT-Z310
HT-TZ312

Digital Home Theater System user manual

imagine the possibilities

Thank you for purchasing this Samsung product.
To receive more complete service,
please register your product at
www.samsung.com/global/register



features

Playback of many disc types

The HT-Z310/HT-TZ312 allows you to play back various discs, including DVD-AUDIO, DVD-VIDEO, CD, MP3-CD, WMA-CD, DivX, CD-R/RW, and DVD±R/RW.

DVD-Audio compatible

Experience the super high-quality audio performance of DVD-Audio. The on-board 24-bit/192kHz DAC enables this player to deliver exceptional sound quality in terms of dynamic range, low-level resolution and high-frequency detail.

USB Host support

You can enjoy media files such as pictures, movies and music saved on an MP3 player, digital camera or USB memory stick by connecting the storage device to the USB port of the Home Theater.

Dolby Pro Logic II

Dolby Pro Logic II is a form of multi-channel audio signal decoding technology that improves upon existing Dolby Pro Logic.

DTS (Digital Theater Systems)

DTS is an audio compression format developed by Digital Theater Systems Inc. It delivers full-frequency 5.1 channel sound.

TV Screen Saver Function

If the main unit remains in Stop mode for 3 minutes, the Samsung logo appears on the TV screen.

The HT-Z310/HT-TZ312 will automatically switch to the Power Saving mode after 20 minutes in the Screen Saver mode.

Power Saving Function

The HT-Z310/HT-TZ312 will automatically shut off after 20 minutes in Stop mode.

Customized TV Screen Display

The HT-Z310/HT-TZ312 allows you to select your favorite image during JPEG or DVD playback and set it as your background wallpaper.

Anynet+ (HDMI-CEC) Function

Anynet+ is a function that can be used to operate the main unit using a Samsung TV remote control, by connecting the Home Theater to a SAMSUNG TV using an HDMI Cable. (This is only available with SAMSUNG TV's that support Anynet+.)

iPod support

You can enjoy music files by connecting your iPod to the home theater with the supplied iPod dock.

AV SYNC Function

Video may lag behind the audio if the unit is connected to a digital TV.

To compensate for this, you can adjust the audio delay time to sync up with the video.

WHAT'S INCLUDED

Check for the supplied accessories below.



Video Cable

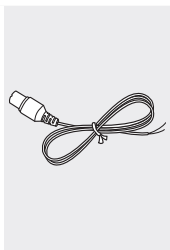

FM Antenna

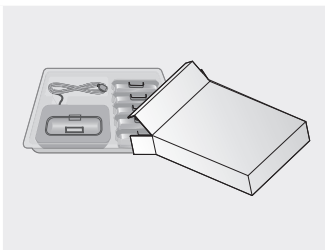

iPod Dock Package

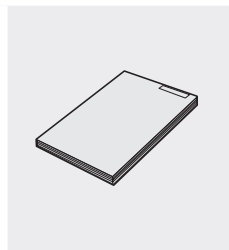

User's Manual

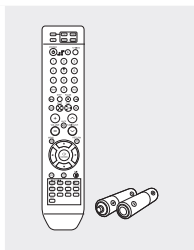

Remote Control / Batteries (AAA size)

safety information

SAFETY WARNINGS

TO REDUCE THE RISK OF ELECTRIC SHOCK, DO NOT REMOVE REAR COVER (or BACK). NO USER SERVICEABLE PARTS INSIDE. REFER SERVICING TO QUALIFIED SERVICE PERSONNEL.



This symbol indicates “dangerous voltage” inside the product that presents a risk of electric shock or personal injury.



This symbol indicates important instructions accompanying the product.

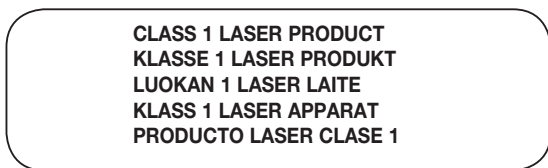

CLASS 1 LASER PRODUCT

This Compact Disc player is classified as a CLASS 1LASER product.

Use of controls, adjustments or performance of procedures other than those specified herein may result in hazardous radiation exposure.

CAUTION : INVISIBLE LASER RADIATION WHEN OPEN AND INTERLOCKS DEFEATED, AVOID EXPOSURE TO BEAM.

Note to CATV system installer

This reminder is provided to call the CATV system installer’s attention to Section 820~40 of the NEC which provides guidelines for proper grounding and, in particular, specifies that the cable ground shall be connected to the grounding system of the building, as close to the point of cable entry as practical.

WARNING

To reduce the risk of fire or electric shock, do not expose this appliance to rain or moisture.

CAUTION

Apparatus shall not be exposed to dripping or splashing and no objects filled with liquids, such as vases, shall be placed on the apparatus.

safety information

IMPORTANT SAFETY INSTRUCTIONS

Read these operating instructions carefully before using the unit. Follow all the safety instructions listed below. Keep these operating instructions handy for future reference.

- 1) Read these instructions.
- 2) Keep these Instructions.
- 3) Heed all warnings.
- 4) Follow all instructions.
- 5) Do not use this apparatus near water.
- 6) Clean only with dry cloth.
- 7) Do not block any ventilation openings. Install in accordance with the manufacturer's instructions.
- 8) Do not install near any heat sources such as radiators, heat registers, stoves, or other apparatus (including amplifiers) that produce heat.
- 9) Do not defeat the safety purpose of the polarized or grounding-type plug. A polarized plug has two blades with one wider than the other. A grounding type plug has two blades and a third grounding prong. The wide blade or the third prong are provided for your safety. If the provided plug does not fit into your outlet, consult an electrician for replacement of the obsolete outlet.
- 10) Protect the power cord from being walked on or pinched particularly at plugs, convenience receptacles, and the point where they exit from the apparatus.
- 11) Only use attachment/accessories specified by the manufacturer.
- 12) Use only with the cart, stand, tripod, bracket, or table specified by the manufacturer, or sold with the apparatus. When a cart is used, use caution when moving the cart/apparatus combination to avoid injury from tip-over.
- 13) Unplug this apparatus during lightning storms or when unused for long periods of time.
- 14) Refer all servicing to qualified service personnel. Servicing is required when the apparatus has been damaged in any way, such as power-supply cord or plug is damaged, liquid has been spilled or objects have fallen into the apparatus, the apparatus has been exposed to rain or moisture, does not operate normally, or has been dropped.



PRECAUTIONS

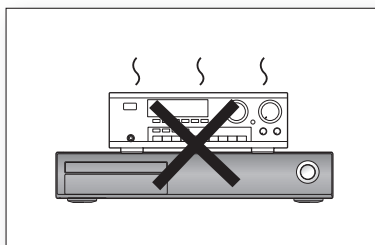
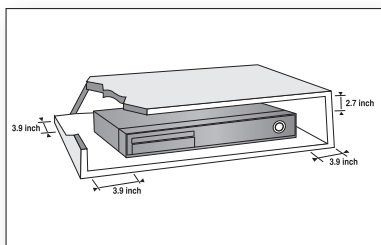

Ensure that the AC power supply in your house complies with the identification sticker located on the back of your player. Install your player horizontally, on a suitable base (furniture), with enough space around it for ventilation (3–4 inches). Make sure the ventilation slots are not covered. Do not stack anything on top of the player. Do not place the player on amplifiers or other equipment which may become hot. Before moving the player, ensure the disc tray is empty. This player is designed for continuous use. Switching off the DVD player to the stand-by mode does not disconnect the electrical supply. In order to disconnect the player completely from the power supply, remove the main plug from the wall outlet, especially when left unused for a long period of time.

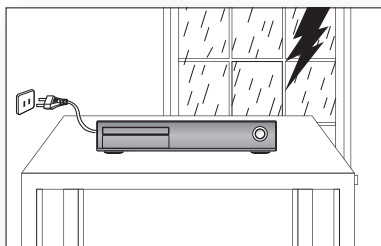

During thunderstorms, disconnect the AC main plug from the wall outlet. Voltage peaks due to lightning could damage the unit.

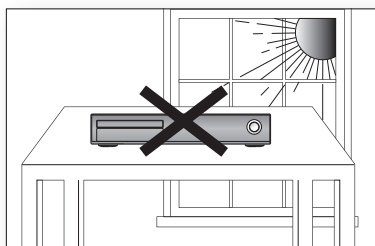

Do not expose the unit to direct sunlight or other heat sources. This could lead to overheating and malfunction of the unit.

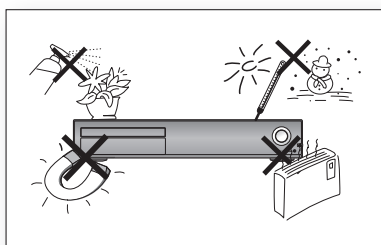

Protect the player from moisture (i.e. vases), and excess heat (e.g. fireplace) or equipment creating strong magnetic or electric fields (i.e. speakers...). Disconnect the power cable from the AC supply if the player malfunctions. Your player is not intended for industrial use. Use of this product is for personal use only.

Condensation may occur if your player or disc has been stored in cold temperatures. If transporting the player during the winter, wait approximately 2 hours until the unit has reached room temperature before using.

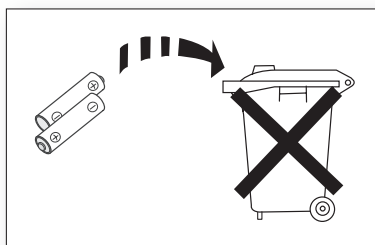

The batteries used with this product contain chemicals that are harmful to the environment. Do not dispose of batteries in the general household trash.

This product is covered by one or more of the following U.S. patents:

5,060,220	5,457,669	5,561,649	5,705,762	5,987,417	6,043,912	6,222,983	6,272,096	6,377,524	6,377,531	6,385,587
6,389,570	6,408,408	6,466,532	6,473,736	6,477,501	6,480,829	6,556,520	6,556,521	6,556,522	6,578,163	6,594,208
6,631,110	6,658,588	6,674,697	6,674,957	6,687,455	6,697,307	6,707,985	6,721,243	6,721,493	6,728,474	6,741,535
6,744,713	6,744,972	6,765,853	6,765,853	6,771,890	6,771,891	6,775,465	6,778,755	6,788,629	6,788,630	6,795,637
6,810,201	6,862,256	6,868,054	6,894,963	6,937,552						

This product is covered by the following U.S. patents:

US4,930,158 US4,930,160

contents

FEATURES	2	What's included
SAFETY INFORMATION	3	Safety Warnings
	4	Important Safety Instructions
	5	Precautions
GETTING STARTED	8	Before Reading the User's Manual
	9	Playable Discs
	9	Do not use the following types of disc!
	9	Copy Protection
	10	Disc Type and Characteristics
DESCRIPTION	11	Front Panel
	12	Display
	13	Rear Panel
REMOTE CONTROL	14	Tour of the Remote Control
	16	Setting the Remote Control
CONNECTIONS	18	Connecting the Speakers
	23	Connecting the Optional Wireless Receiving Amplifier
	25	Connecting the Video Out to your TV
	27	HDMI Function
	28	Connecting an iPod
	30	Connecting Audio from External Components
	32	Connecting the FM Antenna
BEFORE USING YOUR HOME THEATER	33	Before using your home theater
PLAYBACK	34	Disc Playback
	35	MP3/WMA-CD playback
	36	Jpeg File Playback
	37	Divx Playback
	39	Using The Playback Function
	48	Using the iPod
	49	Playing Media Files Using The Usb Host Feature

SYSTEM SETUP

51

- 51 Setting the Language
- 52 Setting TV Screen Type
- 53 Setting Parental Controls (Rating Level)
- 53 Setting the Password
- 54 Setting The Wallpaper
- 54 To Select one of the 3 Wallpaper Settings you've made
- 55 DVD Playback Mode
- 55 Setting the Speaker Mode
- 56 Setting the Delay Time
- 57 Setting the Test Tone
- 57 Setting the Audio
- 58 Setting the DRC (Dynamic Range Compression)
- 59 Setting the AV SYNC
- 59 Setting the HDMI Audio
- 60 Sound field (DSP)/EQ Function
- 60 Dolby Pro Logic II Mode
- 61 Dolby Pro Logic II Effect
- 61 P.BASS

RADIO

62

- 62 Listening To Radio
- 62 Presetting Stations

CONVENIENT FUNCTION

63

- 63 Sleep Timer Function
- 63 Adjusting Display Brightness
- 63 Mute Function

TROUBLESHOOTING

64

- 64 Troubleshooting

USB HOST FEATURE SUPPORTED PRODUCTS

66

- 66 Digital Camera
- 66 USB Flash Disc
- 66 MP3 Player

APPENDIX

67







- 67 Cautions on Handling and Storing Discs
- 68 Specifications
- 69 Warranty

getting started

BEFORE READING THE USER'S MANUAL

Make sure to check the following terms before reading the user manual.

Icons that will be used in manual

Icon	Term	Definition
	DVD	This involves a function available with DVD or DVD-R/DVD-RW discs that have been recorded and finalized in Video Mode.
	CD	This involves a function available with a data CD (CD-R or CD-RW).
	MP3	This involves a function available with CD-R/-RW discs.
	JPEG	This involves a function available with CD-R/-RW discs.
	DivX	This involves a function available with MPEG4 discs. (DVD±R/RW, CD-R or CD-RW)
	Caution	This involves a case where a function does not operate or settings may be cancelled.
	Note	This involves tips or instructions on the page that help each function operate.



- In this manual, the instructions marked with "DVD ()" are applicable to DVD-VIDEO, DVD-AUDIO and DVD-R/-RW discs that have been recorded in Video Mode and then finalized. Where a particular DVD type is mentioned, it is indicated separately.
- If a DVD-R/-RW disc has not been recorded properly in DVD Video format, it will not be playable.

About the use of this user's manual

- 1) Be sure to be familiar with Safety Instructions before using this product. (See pages 3~5)
- 2) If a problem occurs, check the Troubleshooting. (See pages 64~65)

Copyright

©2008 Samsung Electronics Co.,Ltd.

All rights reserved; No part or whole of this user's manual may be reproduced or copied without the prior written permission of Samsung Electronics Co.,Ltd.



DVD (Digital Versatile Disc) offers fantastic audio and video, thanks to Dolby Digital surround sound and MPEG-2 video compression technology. Now you can enjoy these realistic effects in the home, as if you were in a movie theater or concert hall.



DVD players and the discs are coded by region. These regional codes must match in order for the disc to play. If the codes do not match, the disc will not play.

The Region Number for this player is given on the rear panel of the player.

(Your DVD player will only play DVDs that are labeled with identical region codes.)

PLAYABLE DISCS

Disc Type	Mark (Logo)	Recorded Signals	Disc Size	Max. Playing Time
DVD-AUDIO DVD-VIDEO		AUDIO + VIDEO	5 inches	Approx. 240 min. (single-sided)
				Approx. 480 min. (double-sided)
			3 1/2 inches	Approx. 80 min. (single-sided)
				Approx. 160 min. (double-sided)
AUDIO-CD		AUDIO	5 inches	74 min.
			3 1/2 inches	20 min.
DivX		AUDIO + VIDEO	5 inches	—
			3 1/2 inches	—

DO NOT USE THE FOLLOWING TYPES OF DISC!

- LD, CD-G, CD-I, CD-ROM, DVD-ROM and DVD-RAM discs cannot be played on this player. If such discs are played, a <WRONG DISC FORMAT> message appears on the TV screen.
- DVD discs purchased abroad may not play on this player. If such discs are played, a <CAN'T PLAY THIS DISC PLEASE, CHECK REGION CODE> message appears on the TV screen.

COPY PROTECTION

- Many DVD discs are encoded with copy protection. Because of this, you should only connect your DVD player directly to your TV, not to a VCR. Connecting to a VCR results in a distorted picture from copy-protected DVD discs.
- This product incorporates copyright protection technology that is protected by methods claims of certain U.S. patents and other intellectual property rights owned by Macrovision Corporation and other rights owners. Use of this copyright protection technology must be authorized by Macrovision Corporation, and is intended for home and other limited viewing uses only unless otherwise authorized by Macrovision Corporation. Reverse engineering or disassembly is prohibited.

getting started

DISC TYPE AND CHARACTERISTICS

This product does not support Secure (DRM) Media files.

❖ CD-R Discs

- Some CD-R discs may not be playable depending on the disc recording device (CD-Recorder or PC) and the condition of the disc.
- Use a 650MB/74 minute CD-R disc.
Do not use CD-R discs over 700MB/80 minutes as they may not be played back.
- Some CD-RW (Rewritable) media, may not be playable.
- Only CD-Rs that are properly "closed" can be fully played. If the session is closed but the disc is left open, you may not be able to fully play the disc.

❖ CD-R MP3 Discs

- Only CD-R discs with MP3 files in ISO 9660 or Joliet format can be played.
- MP3 file names should be 8 characters or less in length and contain no blank spaces or special characters (. / = +).
- Use discs recorded with a compression/decompression data rate greater than 128Kbps.
- Only files with the "mp3" and extensions can be played.
- Only a consecutively written multisession disc can be played. If there is a blank segment in the Multisession disc, the disc can be played only up to the blank segment.
- If the disc is not closed, it will take longer to begin playback and not all of the recorded files may be played.
- For files encoded in Variable Bit Rate (VBR) format, i.e. files encoded in both low bit rate and high bit rate (e.g., 32Kbps ~ 320Kbps), the sound may skip during playback.
- A maximum of 500 tracks can be played per CD.
- A maximum of 300 folders can be played per CD.

❖ CD-R JPEG Discs

- Only files with the "jpg" extensions can be played.
- If the disc is not closed, it will take longer to start playing and not all of the recorded files may be played.
- Only CD-R discs with JPEG files in ISO 9660 or Joliet format can be played.
- JPEG file names should be 8 characters or less in length and contain no blank spaces or special characters (. / = +).
- Only a consecutively written multisession disc can be played. If there is a blank segment in the multisession disc, the disc can be played only up to the blank segment.
- A maximum of 9,999 images can be stored on a single CD.
- When playing a Kodak/Fuji Picture CD, only the JPEG files in the picture folder can be played.
- Picture discs other than Kodak/Fuji Picture CDs may take longer to start playing or may not play at all.

❖ DVD±R/RW, CD-R/RW DivX Discs

- Since this product only provides encoding formats authorized by DivX Networks, Inc., a DivX file created by the user might not play.
- Software updates for incompatible formats are not supported.
(Example : QPEL, GMC, resolution higher than 800 x 600 pixels, etc.)
- Sections with a high frame rate might not be played while playing a DivX file.
- For more information about the formats authorized by DivX Networks, Inc., please visit "www.divxnetworks.net".

description

FRONT PANEL

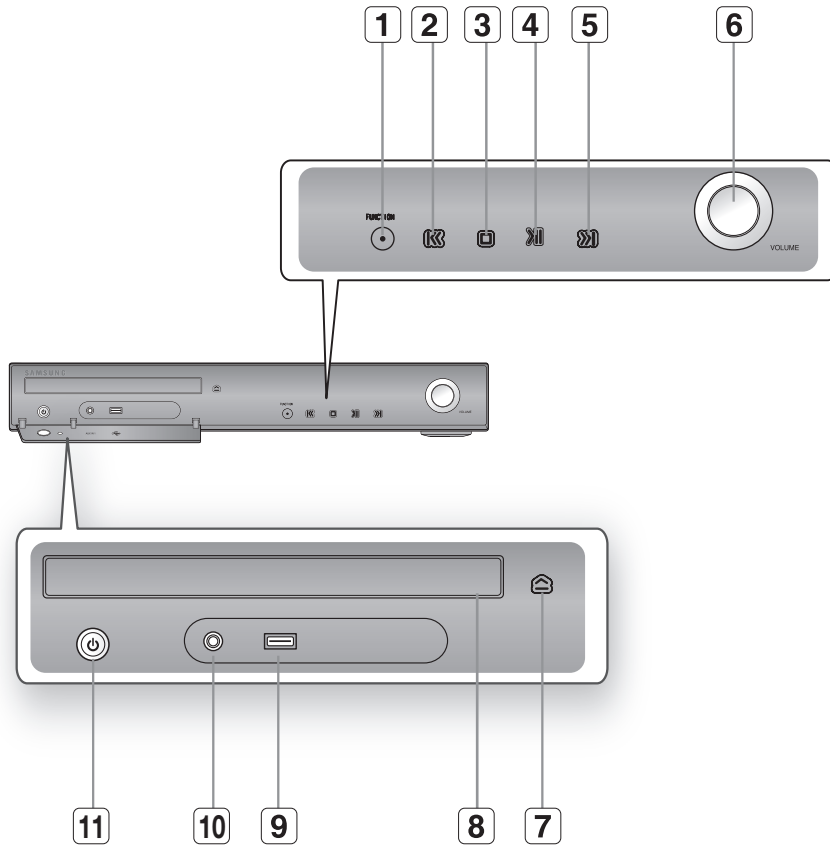

1 FUNCTION BUTTON	5 TUNING UP & SKIP (») BUTTON	9 USB CONNECTOR
2 TUNING DOWN & SKIP («) BUTTON	6 VOLUME CONTROL	10 AUX IN 1 CONNECTOR
3 STOP (■) BUTTON	7 OPEN/CLOSE BUTTON	11 POWER (⏻) BUTTON
4 PLAY/PAUSE (⏮) BUTTON	8 DISC TRAY	

description

DISPLAY

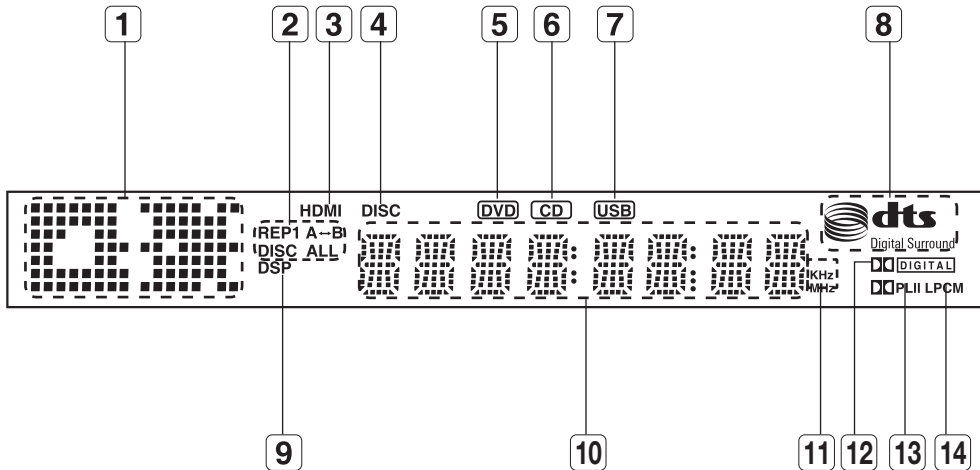

REAR PANEL

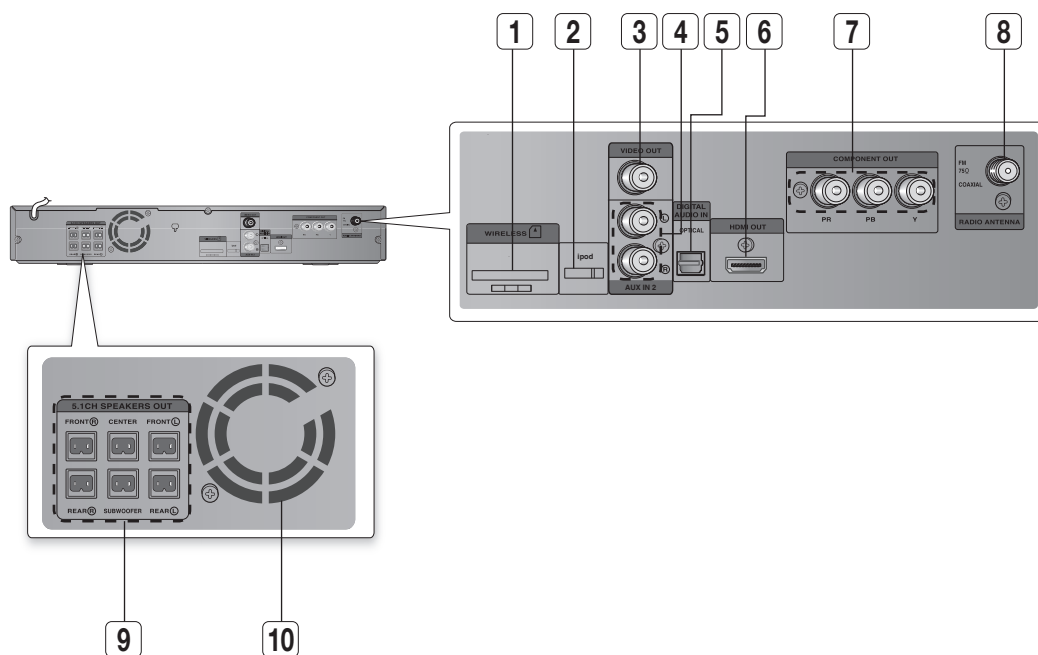



1	TX CARD CONNECTION (WIRELESS)	The TX card enables communication between the main unit and the optional wireless receiver amplifier.
2	iPod JACK	Connect the iPod dock connector here.
3	VIDEO OUTPUT JACK	Connect the TV's Video Input jack (VIDEO IN) to the VIDEO OUT jack.
4	AUX IN 2 JACKS	Connect to the 2CH analog output of an external device (such as a VCR)
5	External Digital Optical Input Jack	Use this to connect external equipment capable of digital output.
6	HDMI OUT JACK	Use the HDMI cable, connect this HDMI output terminal to the HDMI input terminal on your TV for the best quality picture.
7	COMPONENT VIDEO OUTPUT JACKS	Connect a TV with Component video inputs to these jacks.
8	FM 75Ω COAXIAL JACK	Connect the FM antenna.
9	SPEAKER OUTPUT CONNECTORS	Connect the front, center, rear speakers and subwoofer.
10	COOLING FAN	The fan always revolves when the power is on. Ensure a minimum of 4 inches of clear space on all sides of the fan when installing the product.

remote control

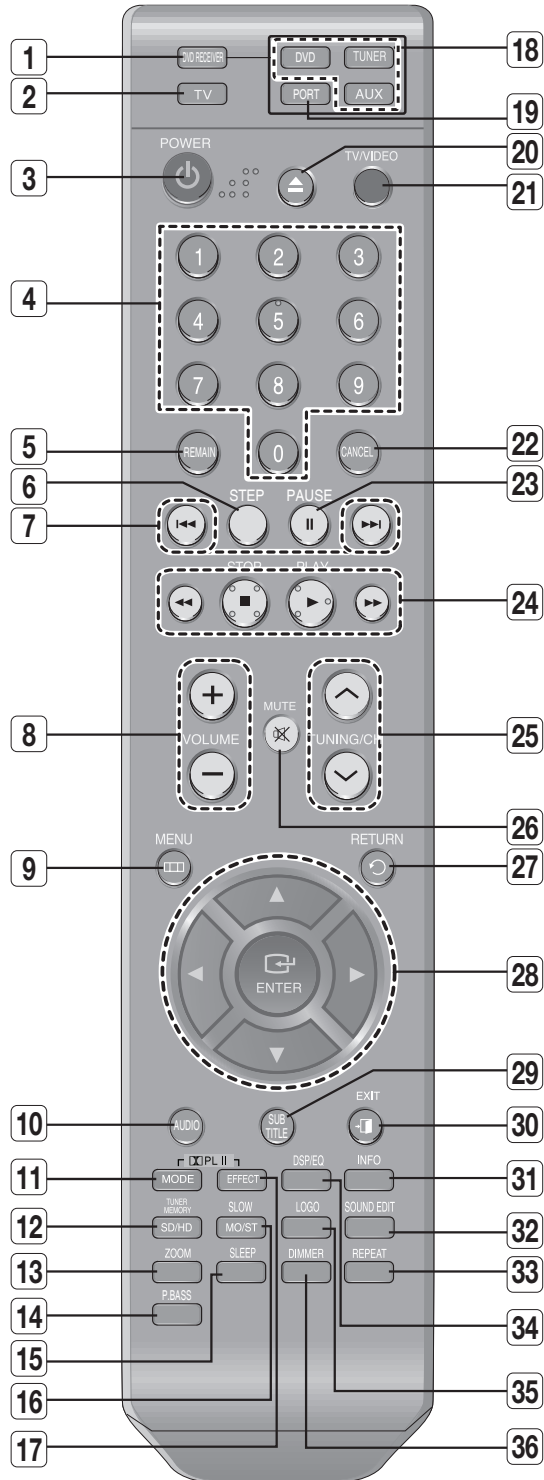
TOUR OF THE REMOTE CONTROL



1	DVD RECEIVER button	19	PORT button
2	TV button	20	⏪ OPEN/CLOSE button
3	POWER button	21	TV/VIDEO button
4	Number (0~9) buttons	22	CANCEL button
5	REMAIN button	23	PAUSE button
6	STEP button	24	▶ PLAY button ■ STOP button ◀▶ SEARCH buttons
7	Tuning Preset/CD Skip buttons	25	TUNING/CH button
8	VOLUME button	26	MUTE button
9	MENU button	27	RETURN button
10	AUDIO button	28	Cursor/ENTER button
11	⏏ PL II MODE button	29	SUBTITLE button
12	TUNER MEMORY, SD(Standard Definition)/HD(High Definition) button	30	EXIT button
13	ZOOM button	31	INFO button
14	P.BASS button	32	SOUND EDIT button
15	SLEEP button	33	REPEAT button
16	SLOW, MO/ST button	34	DSP/EQ button
17	⏏ PL II EFFECT button	35	LOGO button
18	 DVD button  TUNER button  AUX button	36	DIMMER button

Insert Remote Batteries

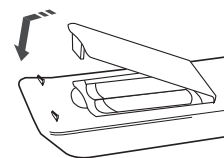
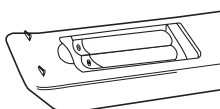
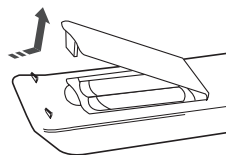

1. Remove the battery cover in the direction of the arrow.

2. Insert two 1.5V AAA batteries, paying attention to the correct polarities (+ and -).

3. Replace the battery cover.



Follow these precautions to avoid leaking or cracking cells:

- Place batteries in the remote control so they match the polarity : (+) to (+) and (-) to (-).
- Use the correct type of batteries. Batteries that look similar may differ in voltage.
- Always replace both batteries at the same time.
- Do not expose the batteries to heat or a flame.

TV Brand Code List

No.	Brand	Code	No.	Brand	Code
1	Admiral (M.Wards)	56, 57, 58	44	MTC	18
2	A Mark	01, 15	45	NEC	18, 19, 20, 40, 59, 60
3	Anam	01, 02, 03, 04, 05, 06, 07, 08, 09, 10, 11,	46	Nikei	03
		12, 13, 14	47	Onking	03
4	AOC	01, 18, 40, 48	48	Onwa	03
5	Bell & Howell (M.Wards)	57, 58, 81	49	Panasonic	06, 07, 08, 09, 54, 66, 67, 73, 74
6	Brocsonic	59, 60	50	Penney	18
7	Candle	18	51	Philco	03, 15, 17, 18, 48, 54, 59, 62, 69, 90
8	Cetronic	03	52	Philips	15, 17, 18, 40, 48, 54, 62, 72
9	Citizen	03, 18, 25	53	Pioneer	63, 66, 80, 91
10	Cinema	97	54	Portland	15, 18, 59
11	Classic	03	55	Proton	40
12	Concerto	18	56	Quasar	06, 66, 67
13	Contec	46	57	Radio Shack	17, 48, 56, 60, 61, 75
14	Coronado	15	58	RCA/Proscan	18, 59, 67, 76, 77, 78, 92, 93, 94
15	Craig	03, 05, 61, 82, 83, 84	59	Realistic	03, 19
16	Croslex	62	60	Sampo	40
17	Crown	03	61	Samsung	00, 15, 16, 17, 40, 43, 46, 47, 48, 49,
18	Curtis Mates	59, 61, 63			59, 60, 98
19	CXC	03	62	Sanyo	19, 61, 65
20	Daewoo	02, 03, 04, 15, 16, 17, 18, 19, 20, 21, 22, 23, 24,	63	Scott	03, 40, 60, 61
		25, 26, 27, 28, 29, 30, 32, 34, 35, 36, 48, 59, 90	64	Sears	15, 18, 19
21	Daytron	40	65	Sharp	15, 57, 64
22	Dynasty	03	66	Signature 2000 (M.Wards)	57, 58
23	Emerson	03, 15, 40, 46, 59, 61, 64, 82, 83, 84, 85	67	Sony	50, 51, 52, 53, 55
24	Fisher	19, 65	68	Soundesign	03, 40
25	Funai	03	69	Spectricon	01
26	Futuretech	03	70	SSS	18
27	General Electric (GE)	06, 40, 56, 59, 66, 67, 68	71	Sylvania	18, 40, 48, 54, 59, 60, 62
28	Hall Mark	40	72	Symphonic	61, 95, 96
29	Hitachi	15, 18, 50, 59, 69	73	Tatung	06
30	Inkel	45	74	Techwood	18
31	JC Penny	56, 59, 67, 86	75	Teknika	03, 15, 18, 25
32	JVC	70	76	TMK	18, 40
33	KTV	59, 61, 87, 88	77	Toshiba	19, 57, 63, 71
34	KEC	03, 15, 40	78	Vidtech	18
35	KMC	15	79	Videch	59, 60, 69
36	LG (Goldstar)	01, 15, 16, 17, 37, 38, 39, 40, 41, 42, 43, 44	80	Wards	15, 17, 18, 40, 48, 54, 60, 64
37	Luxman	18	81	Yamaha	18
38	LXI (Sears)	19, 54, 56, 59, 60, 62, 63, 65, 71	82	York	40
39	Magnavox	15, 17, 18, 48, 54, 59, 60, 62, 72, 89	83	Yupiteru	03
40	Marantz	40, 54	84	Zenith	58, 79
41	Matsui	54	85	Zonda	01
42	MGA	18, 40	86	Dongyang	03, 54
43	Mitsubishi/MGA	18, 40, 59, 60, 75			

connections

This section involves various methods of connecting the Digital Home Theater to other external components. Before moving or installing the product, be sure to turn off the power and disconnect the power cord.

CONNECTING THE SPEAKERS

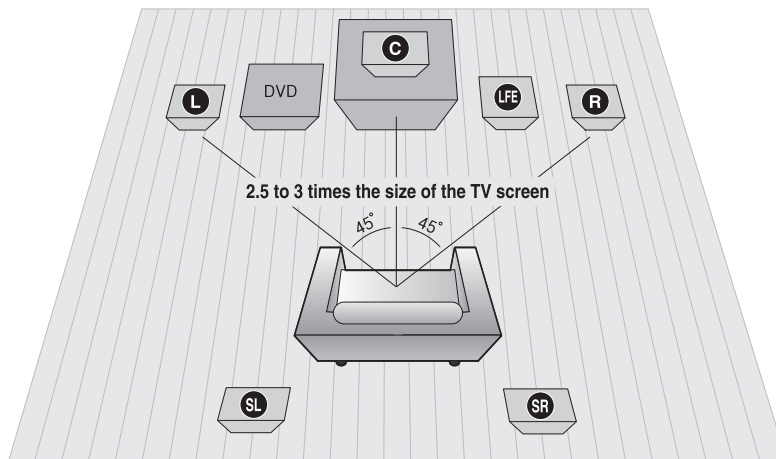

Position of the DVD Player

Place it on a stand or cabinet shelf, or under the TV stand.

Selecting the Listening Position

The listening position should be located about 2.5 to 3 times the distance of the TV's screen size away from the TV.

Example : For 32" TVs 2~2.4m (6~8feet)

For 55" TVs 3.5~4m (11~13feet)

Front Speakers **L** **R**

Place these speakers in front of your listening position, facing inwards (about 45°) toward you.

Place the speakers so that their tweeters will be at the same height as your ear.

Align the front face of the front speakers with the front face of the center speaker or place them slightly in front of the center speakers.

Center Speaker **C**

It is best to install it at the same height as the front speakers. You can also install it directly over or under the TV.

Rear Speakers **SL** **SR**

Place these speakers behind your listening position. If there isn't enough room, place these speakers so they face each other. Place them about 60 to 90cm (2 to 3feet) above your ear, facing slightly downward.

* Unlike the front and center speakers, the rear speakers are used to handle mainly sound effects and sound will not come from them all the time.

Subwoofer **LFE**

The position of the subwoofer is not so critical. Place it anywhere you like.

Speaker Components

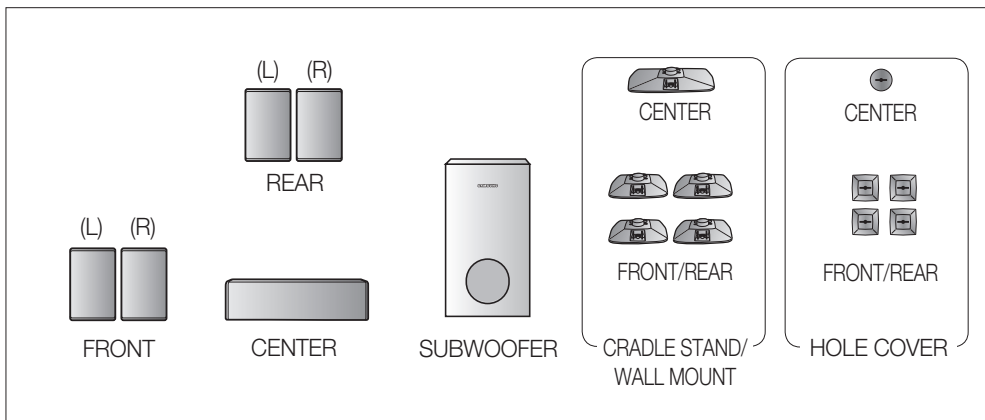

Installing the Cradle Stand

1. Insert the stand so that it fits into the hole as described in the figure.

<Front/Rear>

<Center>

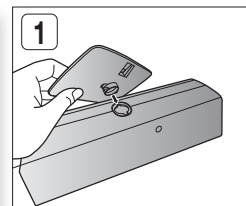
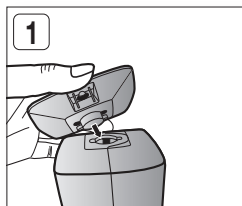

2. Turn the stand clockwise to lock it. (Turning it counter-clockwise will loosen from the hole.)

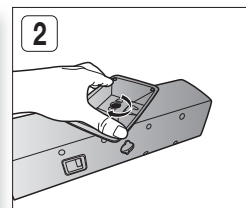
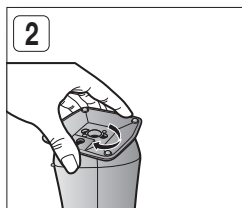

3. This is the completion of the stand installation.

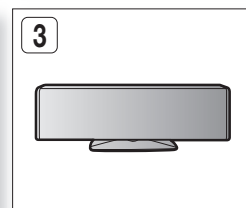
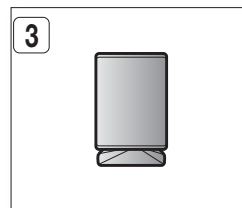

connections

CONNECTING THE SPEAKERS (CON'T)

Installing the Wall Mount

1. Insert the wall mount so that it fits into the rear hole of the speaker as in the figure.

<Front/Rear>

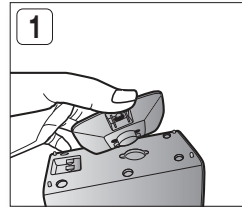

<Center>

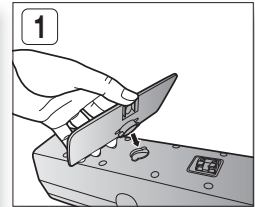

2. Turn the wall mount counter clockwise to fix it. (This is the reverse direction to the cradle stand.)

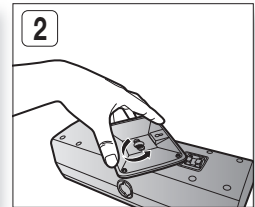
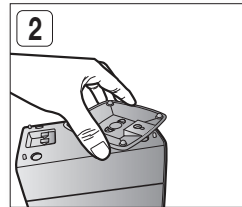

3. Put the hole cover on the hole of the speaker.

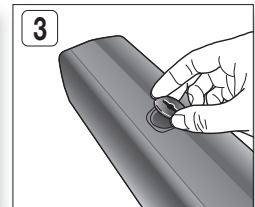

4. Use a coin turn the hole cover clockwise to fix it. (Turning it count-clockwise will loosen from the hole.)

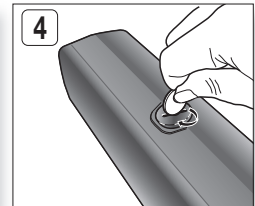
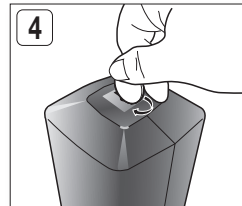

5. Use the wall mount hole (bracket) to install the speaker on the wall.

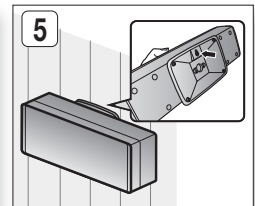
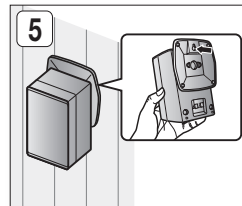

- To avoid accident fall and consequent damage to the customer and speaker, make sure the speaker is hung safely.

Speaker Components

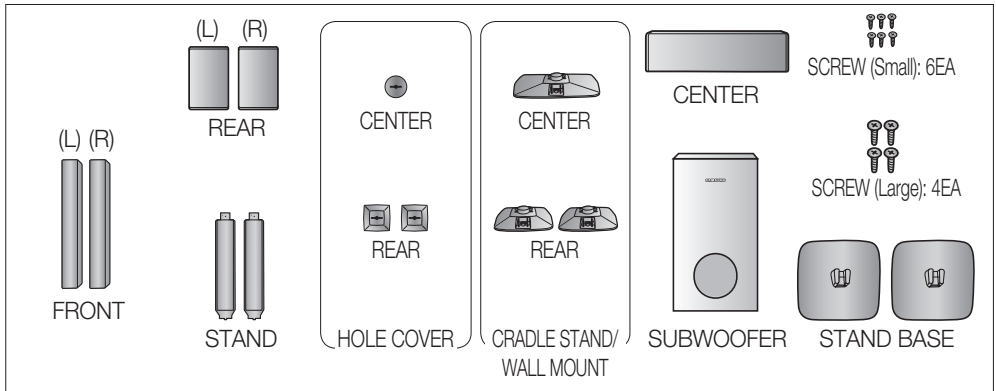

How to Install the Speaker on the Stand

1. Turn the **STAND** upside-down and connect it to the **STAND BASE**.
2. Insert three small **SCREWS** into three holes marked with arrows using a screwdriver as shown in the illustration.
3. Insert a large **SCREW** into the hole on the rear of the Speaker **STAND**.
4. Connect the assembled stand to the **SPEAKER**.
5. Insert another large **SCREW** into the hole on the rear of the speaker using a screwdriver as shown in the illustration.
6. This is the successfully assembled speaker. Make sure that the speaker is installed on a flat and stable area. Otherwise it may be easily knocked over.

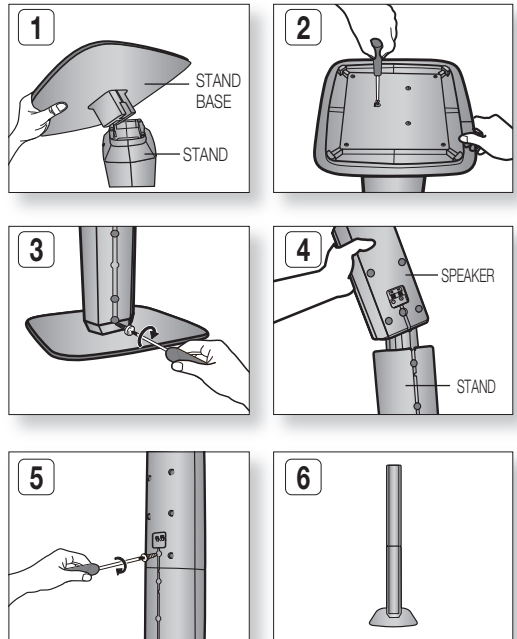

How to Install the Speaker on the Stand Base

1. Connect the **SPEAKER** with the **STAND BASE**.
2. Insert the **SCREW** into the hole on the rear of the speaker using a screwdriver as shown in the illustration.
3. This is the **SPEAKER** successfully assembled with the Stand Base.

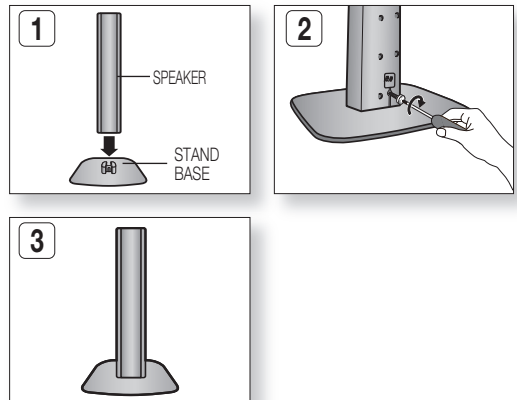

connections

CONNECTING THE SPEAKERS (CON'T)

Connecting the Front, Rear, Center and Subwoofer Speakers

1. Press down the terminal tab on the back of the speaker.
2. Insert the black wire into the black terminal (-) and the red wire into the red (+) terminal, and then release the tab.
3. Connect the connecting plugs to the back of the Home Theater.
 - Make sure the colors of the speaker terminals match the colors of the connecting plugs.

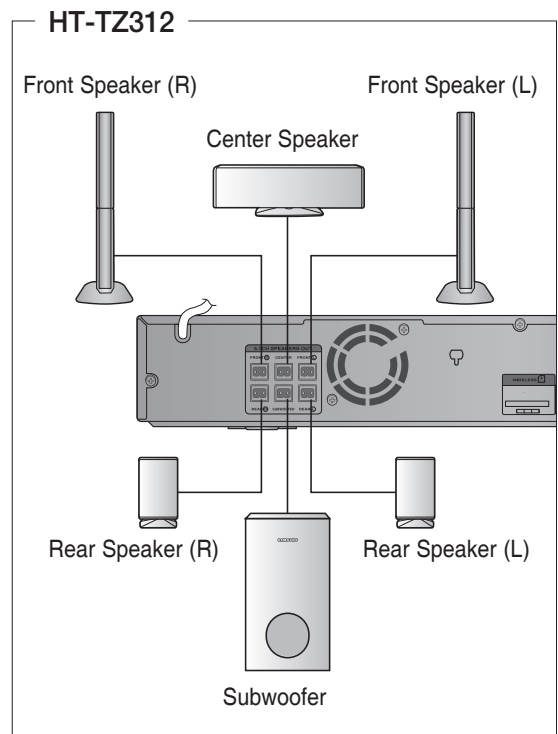
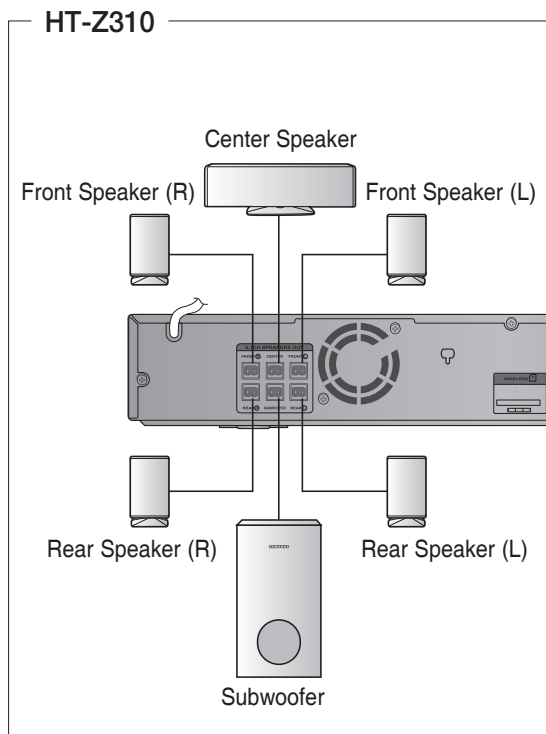
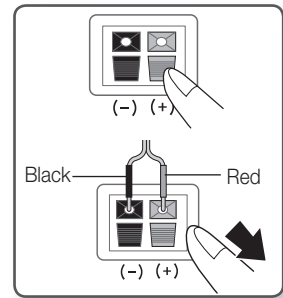

connections

CONNECTING THE OPTIONAL WIRELESS RECEIVING AMPLIFIER (CON'T)

When you have Purchased the Wireless Receiving Module (SWA-4000)

4. Plug the power cord of the wireless receiving module in the wall outlet and switch the power switch **ON**.

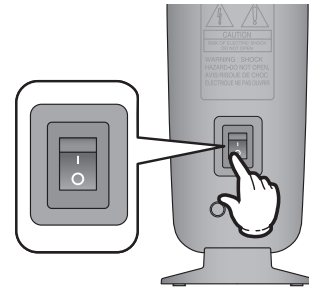

-
- Place the wireless receiver module at the rear of the listening position. If the wireless receiver module is too close to the main unit, some sound interruption may be heard due to interference.
 - If you use a device such as a microwave oven, wireless LAN Card, Bluetooth equipment, or any other device that uses the same frequency (5.8GHz) near the system, some sound interruption may be heard due to interference.
 - The transmission distance from the main unit to the wireless receiving module is about 33 feet (10m), but may vary depending on your operating environment. If a steel-concrete wall or metallic wall is between the main unit and the wireless receiver module, the system may not operate at all, because the radio wave cannot penetrate metal.
 - This product(HT-Z310/HT-TZ312) is also compatible with the wireless receiver module SWA-3000.
 - If the main unit doesn't make wireless connection, the system needs ID Setting between main unit and wireless receiver module. With the main unit turned off, press remote control's number button "0"→"1"→"3"→"5" and unit turned on. With the wireless receiver module turned on, press "ID SET" button on the back of the unit for 5 seconds.

-
- Do not insert any other card except the TX card dedicated to the product. If a different TX card is used, the product may be damaged or the card may not be removed easily.
 - Do not insert the TX card upside down or in the reverse direction.
 - Insert the TX card when the DVD Player is turned off. Inserting the card when it is turned on may cause a problem.
 - If the TX Card is inserted and wireless receiving module setting is complete, sound is not output from the Rear Speaker connectors on the main unit.
 - The wireless receiving antenna is built into the wireless receiver module. Keep the unit away from water and moisture.
 - For optimal listening performance, make sure that the area around the wireless receiver module location is clear of any obstructions.
 - **If no sound is heard from the wireless rear speakers, switch the mode to DVD 5.1 channel or Dolby ProLogic II .**
 - In 2-CH mode, no sound will be heard from the wireless rear speakers.

connections

CONNECTING THE OPTIONAL WIRELESS RECEIVING AMPLIFIER (CON'T)

When you have Purchased the Wireless Receiving Module (SWA-4000)

4. Plug the power cord of the wireless receiving module in the wall outlet and switch the power switch **ON**.

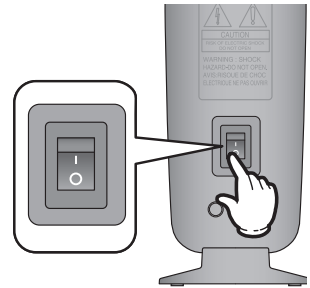

- Place the wireless receiver module at the rear of the listening position. If the wireless receiver module is too close to the main unit, some sound interruption may be heard due to interference.
- If you use a device such as a microwave oven, wireless LAN Card, Bluetooth equipment, or any other device that uses the same frequency (5.8GHz) near the system, some sound interruption may be heard due to interference.
- The transmission distance from the main unit to the wireless receiving module is about 33 feet (10m), but may vary depending on your operating environment. If a steel-concrete wall or metallic wall is between the main unit and the wireless receiver module, the system may not operate at all, because the radio wave cannot penetrate metal.
- This product(HTZ310/HT-TZ-312) is also compatible with the wireless receiver module SWA-3000.
- If the main unit doesn't make wireless connection, the system needs ID Setting between main unit and wireless receiver module. With the main unit turned off, press remote control's number button "0"→"1"→"3"→"5" and unit turned on. With the wireless receiver module turned on, press "ID SET" button on the back of the unit for 5 seconds.

- Do not insert any other card except the TX card dedicated to the product. If a different TX card is used, the product may be damaged or the card may not be removed easily.
- Do not insert the TX card upside down or in the reverse direction.
- Insert the TX card when the DVD Player is turned off. Inserting the card when it is turned on may cause a problem.
- If the TX Card is inserted and wireless receiving module setting is complete, sound is not output from the Rear Speaker connectors on the main unit.
- The wireless receiving antenna is built into the wireless receiver module. Keep the unit away from water and moisture.
- For optimal listening performance, make sure that the area around the wireless receiver module location is clear of any obstructions.
- **If no sound is heard from the wireless rear speakers, switch the mode to DVD 5.1 channel or Dolby ProLogic II .**
- In 2-CH mode, no sound will be heard from the wireless rear speakers.

CONNECTING THE VIDEO OUT TO YOUR TV

Choose one of the three methods for connecting to a TV.

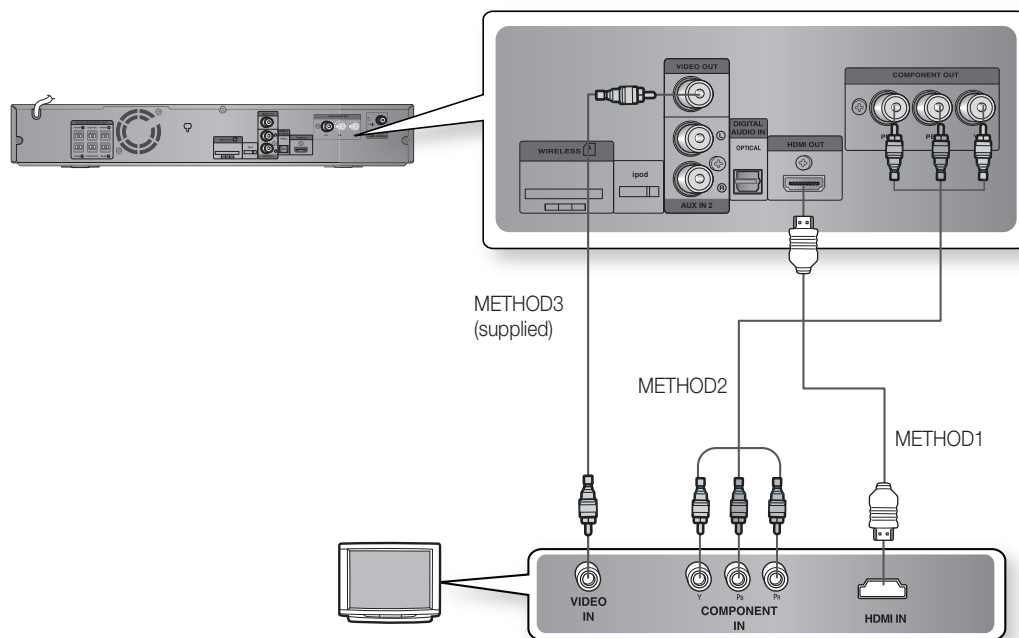

METHOD 1 : HDMI

Connect the HDMI cable from the HDMI OUT jack on the back of the DVD Home Theater to the HDMI IN jack on your TV.

METHOD 2 : Component Video

If your television is equipped with Component Video inputs, connect a component video cable(not supplied) from the Component Video Output (Pr, Pb and Y) Connectors on the back of the main unit to the Component Video Input Connectors on your TV.

METHOD 3 : Composite Video

Connect the supplied video cable from the VIDEO OUT jack on the back of the main unit to the VIDEO IN jack on your TV.



- Resolutions available for the HDMI output are 480p, 720p,1080i/1080p.
- This product operates in Interlace scan mode (480i) for Component Output.
- After making the video connection, set the Video input source on your TV to match the corresponding Video output (HDMI, Component or Composite) on your Home theater. See your TV owner's manual for more information on how to select the TV's Video Input source.
- If you use an HDMI cable to connect a Samsung TV to the main unit, you can operate the Home Theater using the TV's remote control. (This is only available with SAMSUNG TVs that support Anynet+(HDMI-CEC).)
- Please check the **Anynet+** logo (If your TV has an **Anynet+** logo, then it supports Anynet+ function.)

CONNECTING THE VIDEO OUT TO YOUR TV (CON'T)

HDMI Auto Detection Function

The player's video output will automatically change to HDMI mode when connecting an HDMI cable while power is on. For possible HDMI resolutions, see page 27.

- **HDMI (High Definition Multimedia Interface)**

HDMI is an interface that enables the digital transmission of video and audio data with just a single connector.

Using HDMI, the DVD Home Theater transmits a digital video and audio signal and displays a vivid picture on a TV having an HDMI input jack.

- **HDMI connection description**

HDMI connector - Supports video and digital audio data.

- HDMI outputs only a pure digital signal to the TV.

- If your TV does not support HDCP (High-bandwidth Digital Content Protection), random noise appears on the screen.

- **Why does Samsung use HDMI?**

Analog TVs require an analog video/audio signal. However, when playing a DVD, the data transmitted to a TV is digital. Therefore either a digital-to-analog converter (in the DVD Home Theater) or an analog-to-digital converter (in the TV) is required. During this conversion, the picture quality is degraded due to noise and signal loss. HDMI technology is superior because it requires no D/A conversion and is a pure digital signal from the player to your TV.

- **What is the HDCP?**

HDCP (High-band width Digital Content Protection) is a system for protecting DVD content outputted via HDMI from being copied. It provides a secure digital link between a video source (PC, DVD, etc) and a display device (TV, projector, etc). Content is encrypted at the source device to prevent unauthorized copies from being made.

- **What is Anynet+?**

Anynet+ is a convenient function that offers linked operation of this unit through Samsung TVs with the Anynet+ feature.

- If your Samsung TV has an  logo, then it supports the Anynet+ function.

- If you turn on the player and insert a disc, the player will start playing the disc, and the TV will turn on automatically and switch to HDMI mode.

- If you turn on the player and press the Play button with a disc already inserted, the TV will immediately turn on and switch to HDMI mode.

HDMI FUNCTION

Resolution Selection

This function allows the user to select the screen resolution for HDMI output.

In Stop mode, press and hold the **SD/HD** (Standard Definition/High Definition) button on the remote control.

- Resolutions available for the HDMI output are 480p, 720p, 1080i/1080p.
- SD(Standard Definition) resolution is 480p and HD (High Definition) resolution is 720p, 1080i/1080p.

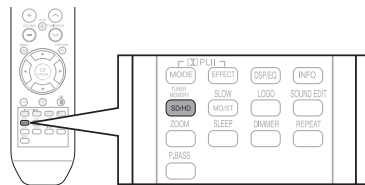

- If the TV does not support the configured resolution, you will not be able to see the picture properly.
- When an HDMI cable is connected, composite and component video signals are not output.
- See your TV owner's manual for more information on how to select the TV's Video Input source.

Why use HDMI (High Definition Multimedia Interface)?

This device transmits a DVD video signal digitally without the process of converting to analog. You will get sharper digital pictures when using an HDMI connection.

Using Anynet+(HDMI-CEC)

Anynet+ is a function that enables you to control other Samsung Devices with your Samsung TV's remote control, Anynet + can be used by connecting this Home Theater to a SAMSUNG TV using an HDMI Cable. This is only available with SAMSUNG TVs that support Anynet+.

1. Connect the main unit of the Home Theater to a Samsung TV with an HDMI cable. (See page 25)
2. Set the Anynet+ function on your TV. (See the TV instruction manual for more information.)
 - You can operate the Home Theater by using the TV remote control. (Available TV buttons : ◀, ■, ▶, ▶▶, ▲, ▼ and ◀▶ buttons, ① ~ ⑨ button)

With Anynet+

You can operate this unit, power on your TV, or watch a movie by pressing the Play button on your Samsung TV's remote control.



If you select the TV

Set the Anynet+(HDMI-CEC) to On by pressing the Anynet+ button on your TV remote control.

- **Receiver : On** : You can listen to audio through the Home Theater.
- **Receiver : Off** : You can listen to audio through the TV.

If you select the THEATER

Select **THEATER to connect** and set the option of each item below.

- **View TV** : If anynet+(HDMI CEC) is set to on and you select View TV, the home theater will automatically switch to digital in mode.
- **Theater Menu** : you can access and control the Home theater menu.
- **Theater Operation** : The Home Theater disc playback information will be displayed. You can control the Disc operation of the Home Theater such as title, chapter and subtitle change.
- **Receiver : On** : You can listen to audio through the Home Theater.
- **Receiver : Off** : You can listen to audio through the TV.



- In case that you chose 'View TV', if you want to listen to TV sound through Digital In, you have to connect the optical cable between the TV and the Home Theater.

connections

CONNECTING AN iPod

You can listen to the audio from an iPod through the main unit. For iPod operation with this Home Theater, see pages 29 and 48.

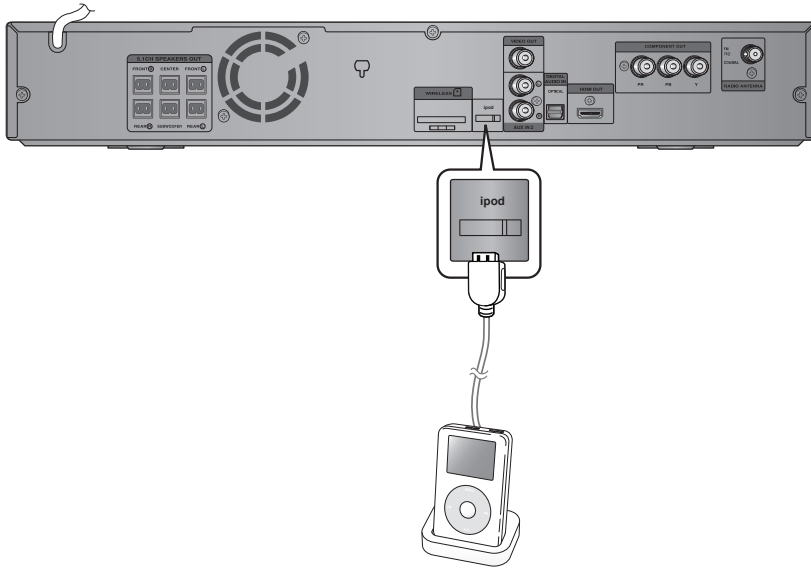







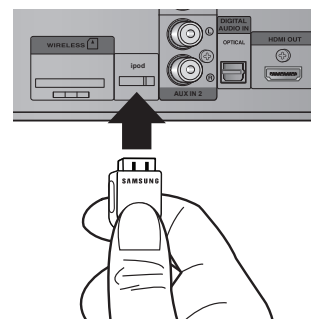

1. Connect the iPod dock connector to the iPod jack on the DVD home theater.
2. Press the **PORT** button on the remote control to select **iPod** input.
 - You can also use the **FUNCTION** button on the main unit.
The mode switches as follows :
DVD/CD → D.IN → AUX 1 → AUX 2 → USB → OSD IPOD → FM.











- As the cable ports are close together, be sure to remove the wireless adaptor before disconnecting the ipod docking cable.
- Depending on the type of iPod. You may need to insert one of the dock slots into the dock before you station your iPod (see next page).
- Adjust the volume to a moderate level before you connect your iPod and DVD home theater.
- When the unit is powered on and you connect an iPod, the unit will charge your iPod's battery.
- Make sure to connect the dock connector so that the label "**SAMSUNG**" faces upward.

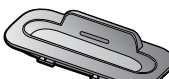

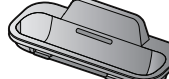
iPod models compatible with the dock

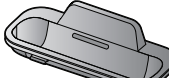
 mini (4GB, 6GB)	 20GB	 40GB
 20GB, 30GB (color display)	 40GB, 60GB (color display)	 nano (1GB, 2GB, 4GB)
 nano (aluminum) (2GB, 4GB, 8GB)	 30GB (video)	 60GB, 80GB (video)

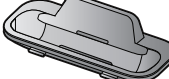
The following 5 models must be used with the applicable dock insert as well as the dock before they can be connected to the system.

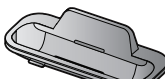
 iPhone (4GB, 8GB)	→		AH81-04244A	 classic (80GB)	→		AH81-04241A
 classic (160GB)	→		AH81-04242A	 nano (video) (4GB, 8GB)	→		AH81-04243A
 touch (8GB, 16GB)	→		AH81-04245A				

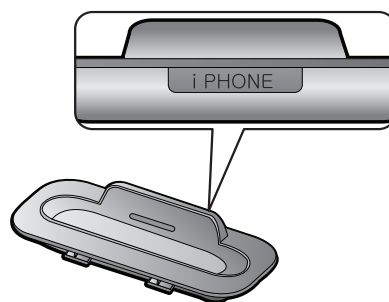
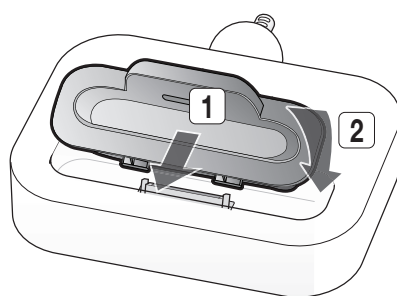

- The provided dock insert includes 5 different types. Check the dock insert for the iPod model name on its rear side before use. (The dock insert for Classic 160 GB has the model name on the bottom.)

connections

CONNECTING AUDIO FROM EXTERNAL COMPONENTS

AUX1 : Connecting an External Component/MP3 player

Components such as an MP3 Player.

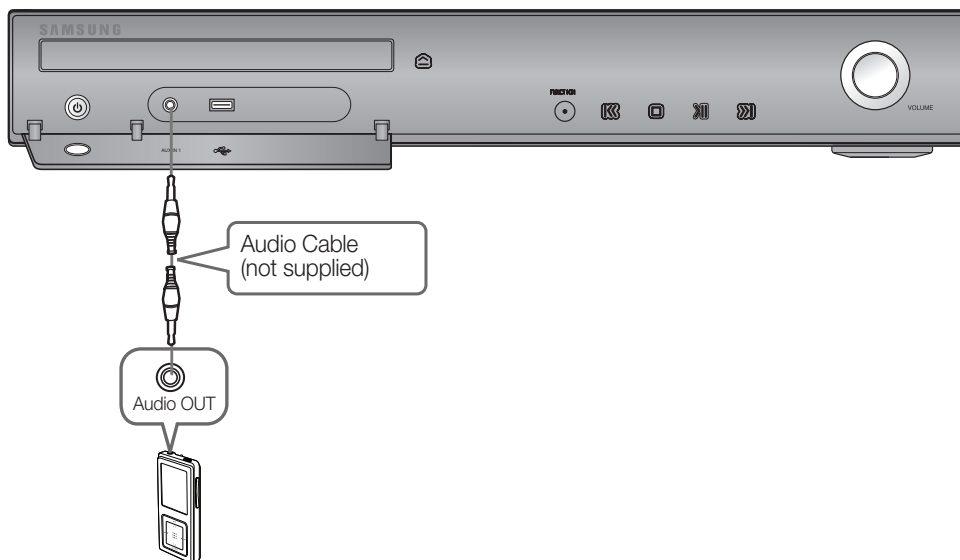

1. Connect AUX IN 1 (Audio) on the Home Theater to the Audio Out of the external component/MP3 player.
2. Press the **AUX** button on the remote control to select **AUX1** input.
 - You can also use the **FUNCTION** button on the main unit.
The mode switches as follows :
DVD/CD → D.IN → AUX 1 → AUX 2 → USB → OSD iPOD → FM.

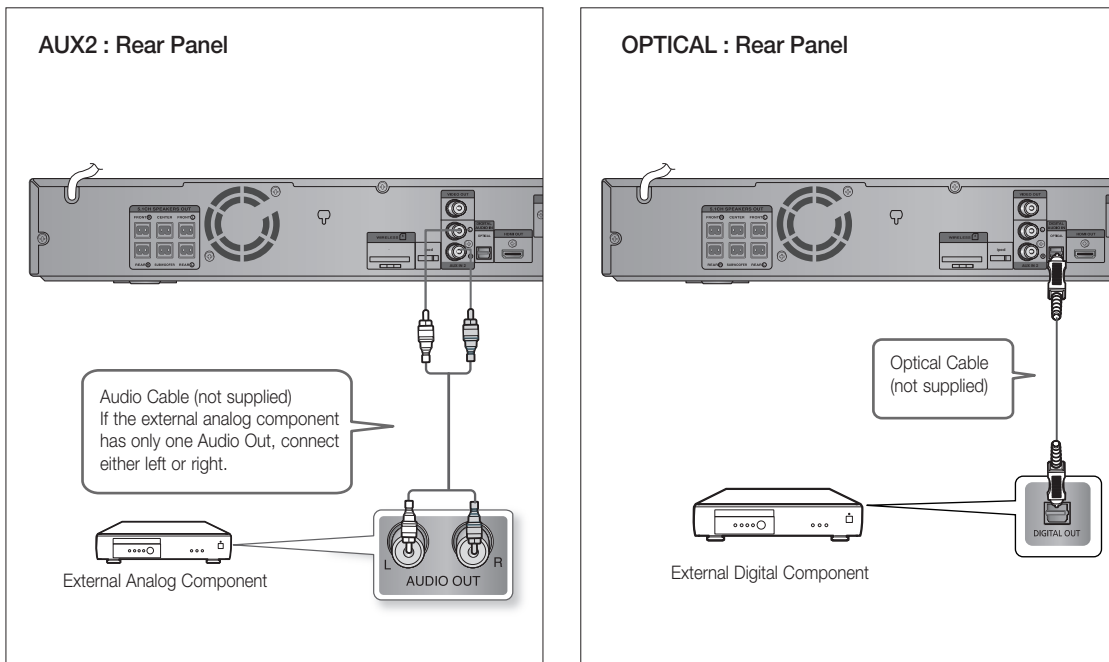

AUX2 : Connecting an External Analog Component

Analogue signal components such as a VCR.

1. Connect AUX IN 2 (Audio) on the Home Theater to the Audio Out of the external analog component.
 - Be sure to match connector colors.
2. Press the **AUX** button on the remote control to select **AUX 2** input.
 - You can also use the **FUNCTION** button on the main unit.
The mode switches as follows :
DVD/CD → D.IN → AUX 1 → AUX 2 → USB → OSD iPOD → FM.



- You can connect the Video Output jack of your VCR to the TV, and connect the Audio Output jacks of the VCR to this product.

OPTICAL : Connecting an External Digital Component

Digital signal components such as a Cable Box/Satellite receiver (Set-Top Box).

1. Connect the Digital Input (OPTICAL) on the Home Theater to the Digital Output of the external digital component.
2. Press the **AUX** button on the remote control to select **DIGITAL IN**.
 - You can also use the **FUNCTION** button on the main unit.
The mode switches as follows :
DVD/CD → D.IN → AUX 1 → AUX 2 → USB → OSD iPOD → FM.

connections

CONNECTING THE FM ANTENNA

1. Connect the FM antenna supplied to the FM 75Ω COAXIAL Jack.
2. Slowly move the antenna wire around until you find a location where reception is good, then fasten it to a wall or other rigid surface.

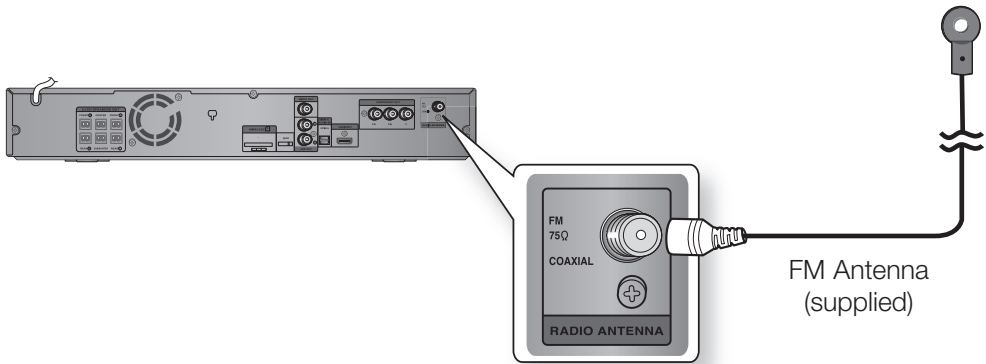

- This unit does not receive AM broadcasts.

Cooling Fan

The cooling fan supplies cool air to the unit to prevent overheating. Please observe the following cautions for your safety.

- Make sure the unit is well-ventilated. If the unit has poor ventilation, the temperature inside the unit may rise and may damage it.
- Do not obstruct the cooling fan or ventilation holes. (If the cooling fan or ventilation holes are covered with a newspaper or cloth, heat may build up inside the unit and fire may result.)

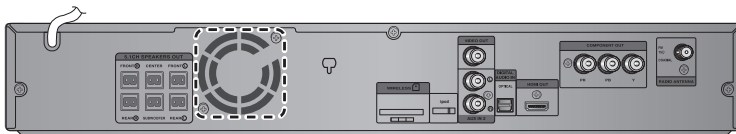

before using your home theater

The DVD Home Theater's remote can be used to control Samsung TVs.

1. Plug the main unit's power cord into the AC power supply.



2. Press the **DVD RECEIVER** button to operate the DVD Home Theater.
3. Press the **FUNCTION** button on the main unit or **DVD** button on the remote to enable DVD/CD playback.
4. Press the **TV** button to set the remote to TV mode.
5. Press the **POWER** button to turn on your Samsung TV with this remote.
6. Press the **TV/VIDEO** button to select VIDEO mode on your TV.

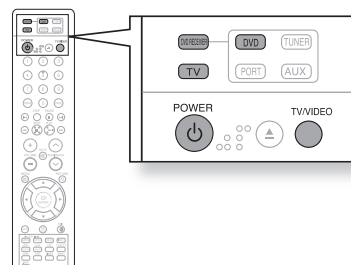

DISC PLAYBACK



1. Press the **OPEN/CLOSE** (⏏) button to open the disc tray.
2. Load a disc.
 - Place a disc gently into the tray with the disc's label facing up.
3. Close the compartment by pressing the **OPEN/CLOSE** (⏏) button again.
 - Playback starts automatically.

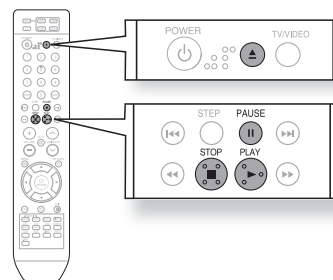

To stop playback, press the **STOP** (⏏) button during playback.

- If pressed once, **PRESS PLAY** is displayed and the stop position will be stored in memory. If the **PLAY** (⏏) button or **ENTER** button is pressed, playback resumes from the stop position. (This function works only with DVDs.)
- If pressed twice, **STOP** is displayed, and if the **PLAY** (⏏) button is pressed, playback starts from the beginning.

To temporarily pause playback, press the **PAUSE** (⏏) button during playback.

- To resume playback, press the **PLAY** (⏏) button.



- Depending on the content of the disc, the initial screen may appear different.
- Pirated discs will not run in this player because it violates the CSS (Content Scrambling System : a copy protection system) recommendations.

MP3/WMA-CD PLAYBACK

Data CDs (CD-R, CD-RW) encoded in MP3/WMA format can be played.



- Place the MP3/WMA disc on the disc tray.
 - The MP3/WMA menu screen will appear and playback will start.
 - The appearance of the menu depends on the MP3/WMA disc.
 - WMA-DRM files cannot be played.
- In Stop mode, use the Cursor **▲, ▼, ◀, ▶** button to select the album, and then press the **ENTER** button.
 - Use the Cursor **▲, ▼** button to select the track.
- To change the album, use the Cursor **▲, ▼, ◀, ▶** button to select another album in Stop mode, and then press the **ENTER** button.
- Press the **STOP** (■) button to stop playback.

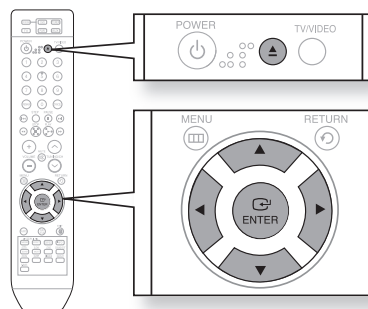

- Depending on the recording mode, some MP3/WMA-CDs may not play.
- Table of contents of a MP3-CD varies depending on the MP3/WMA track format recorded on the disc.

To play a file icon in the screen,

- Press the Cursor **▲, ▼, ◀, ▶** button when it is in Stop mode and select a desired icon from the top part of the menu.

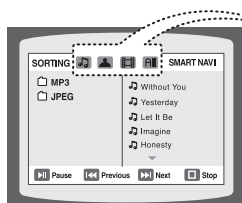

- Music File Icon** : To play music files only, select the icon.
- Image File Icon** : To view image files only, select the icon.
- Movie File Icon** : To view movie files only, select the icon.
- All File Icon** : To view all files select the icon.

playback

JPEG FILE PLAYBACK

Images captured with a digital camera or camcorder, or JPEG files on a PC can be stored on a CD and then played back with this Home Theater.

Slide Mode



Place the JPEG disc on the disc tray.

- Playback starts automatically. Each image is displayed for 5 seconds and then the next image is displayed.

Press the **⏪, ⏩** button to skip to the next slide.

- Each time the button is pressed, the slide moves backward or forward.

Rotate/Flip Function



Press the Cursor **▲, ▼, ◀, ▶** button during playback.

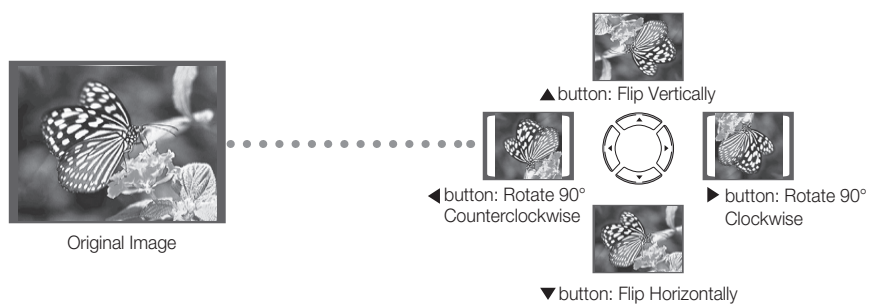
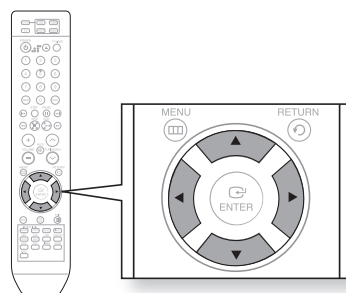

- The maximum resolutions supported by this product are 5120 x 3480 (or 19.0 MPixel) for standard JPEG files and 2048 x 1536 (or 3.0 MPixel) for progressive image files.
- If a JPEG file is played when the HDMI output resolution is 720p/1080i/1080p, the mode is automatically converted to 480p mode.

DIVX PLAYBACK

The functions on this page apply to DivX disc playback.

Skip Forward/Back



During playback, press the **◀▶** button.

- Goes to the next file whenever you press the **▶▶** button, if there are over 2 files in the disc.
- Goes to the previous file whenever you press the **◀◀** button, if there are over 2 files in the disc.

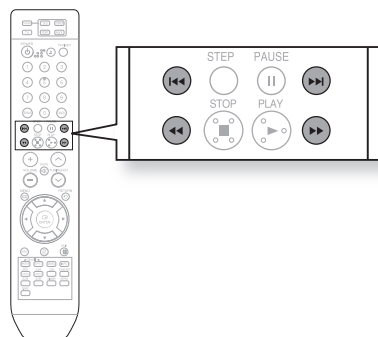

Fast Playback



During playback, press the **◀▶** button.

To play back the disc at a faster speed, press the **◀◀** or **▶▶** button during playback.

- Each time you press either button, the playback speed will change as follows:
2x → 4x → 8x → 32x → Normal.

5 Minute Skip function



During playback, press the Cursor **◀▶** button.

- Playback skips 5 minutes forward whenever you press the Cursor **▶** button.
- Playback skips 5 minutes back whenever you press the Cursor **◀** button.

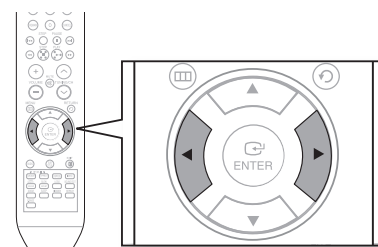

Audio Display



Press the **AUDIO** button.

- If there are multiple audio languages on a disc, you can toggle between them.
- Each time you press the button, your selection will toggle between **AUDIO (1/N, 2/N ...)** and .

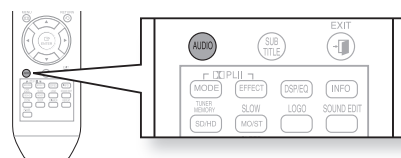

▪ is displayed when there is one supported language in the disc.

Subtitle Display



Press the **SUBTITLE** button.

- Each time you press the button, your selection will toggle between **SUBTITLE (1/N, 2/N ...)** and **SUBTITLE OFF**.
- If the disc has only one subtitle file, it will be played automatically.
- See number 2 (Caption Function) on the next page for more details concerning Subtitle usage with DivX discs.

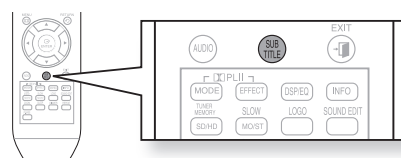

USING THE PLAYBACK FUNCTION

Displaying Disc Information



You can view disc playback information on the TV screen.

Press the **INFO** button.



- Depending on the disc, the disc information display may appear different.
- Depending on the disc, you can also select DTS, DOLBY DIGITAL, or PRO LOGIC.

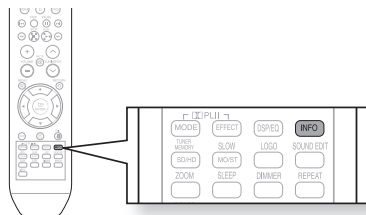

appears on the TV screen!

If this symbol appears on the TV screen when pressing a button, that operation is not possible with the disc currently being played.



Checking the Remaining Time



Press the **REMAIN** button.

- For checking the total and remaining time of a title or chapter being played.

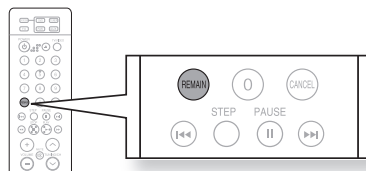

Each time the Remain button is pressed



TITLE ELAPSED → TITLE REMAIN → CHAPTER ELAPSED → CHAPTER REMAIN



GROUP ELAPSED → GROUP REMAIN → TRACK ELAPSED → TRACK REMAIN



TRACK ELAPSED → TRACK REMAIN → TOTAL ELAPSED → TOTAL REMAIN



TRACK REMAIN → TRACK ELAPSED

playback

USING THE PLAYBACK FUNCTION

Fast Playback



Press the **◀▶** button.

- Each time the button is pressed during playback, the playback speed changes as follows:

◀▶ ◀◀ 2X → ◀◀ 4X → ◀◀ 8X → ◀◀ 32X → ▶▶ PLAY

▶▶ ▶▶ 2X → ▶▶ 4X → ▶▶ 8X → ▶▶ 32X → ▶▶ PLAY

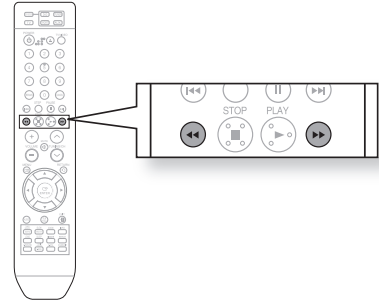

- During fast playback of a CD or MP3-CD, sound is heard only at 2x speed, and not at 4x, 8x, and 32x speeds.

Slow Playback



Press the **SLOW** button.

- Each time the button is pressed during playback, the playback speed changes as follows:

▶▶ 1/2 → ▶▶ 1/4 → ▶▶ 1/8 → ◀◀ 1/2 → ◀◀ 1/4 → ◀◀ 1/8 → ▶▶ PLAY

▶▶ 1/2 → ▶▶ 1/4 → ▶▶ 1/8 → ▶▶ PLAY

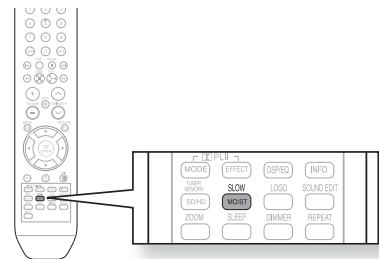

- No sound is heard during slow playback.
- Reverse slow playback does not work with CD.

Skipping Scenes/Songs



Press the **◀◀▶▶** button.

- Each time the button is pressed during playback, the previous or next chapter, track or directory (file) will be played.
- You cannot skip chapters consecutively.

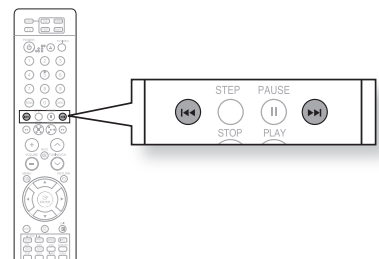

Repeat Playback



Repeat playback allows you to repeatedly play a chapter, title, track (song), or directory (MP3 file).

Press the **REPEAT** button.

- Each time the button is pressed during playback, the repeat playback mode changes as follows:

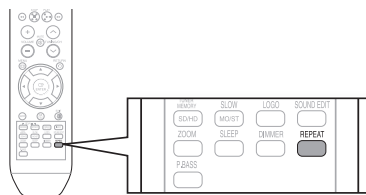

REPEAT : CHAPTER → REPEAT : TITLE → REPEAT : OFF



REPEAT : TRACK → REPEAT : GROUP → REPEAT : OFF



REPEAT : TRACK → REPEAT : DISC → REPEAT : OFF



**REPEAT : RANDOM → REPEAT : TRACK → REPEAT : DIR → REPEAT : DISC
→ REPEAT : OFF**

Repeat Playback Options

CHAPTER : Repeatedly plays the selected chapter.

TITLE : Repeatedly plays the selected title.

GROUP : Repeatedly plays the selected group.

RANDOM : Plays tracks in random order. (A track that has already been played may be played again.)

TRACK : Repeatedly plays the selected track.

DIR : Repeatedly plays all tracks in the selected folder.

DISC : Repeatedly plays the entire disc.

OFF : Cancels Repeat Playback.

To Select a Repeat Playback Mode in the Disc Information Screen



- Press the **INFO** button twice.
- Press the Cursor **▶** button to move to REPEAT PLAYBACK (⏮) display.
- Press the Cursor **▼** button to select the desired Repeat Playback mode.
 - To select another album and track, repeat Steps 2 and 3 above.
- Press the **ENTER** button.

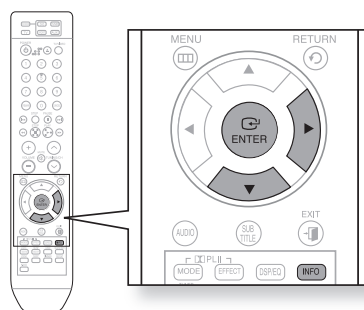

OFF → A- → CHAP → TITLE → OFF



OFF → A- → TRACK → DISC → OFF



- For DivX, MP3 and JPEG discs, you cannot select Repeat Play from the information display screen.

playback

USING THE PLAYBACK FUNCTION

A-B Repeat Playback



You can repeatedly play back a designated section of a DVD.

1. Press the **INFO** button twice.
2. Press the Cursor **▶** button to move to REPEAT PLAYBACK (↻) display.
3. Press the Cursor **▲, ▼** button to select **A-** and then press the **ENTER** button.
 - When the **ENTER** button is pressed, the selected position will be stored in memory.
4. Press the **ENTER** button at the end of the desired segment.
 - The specified segment will be played repeatedly.

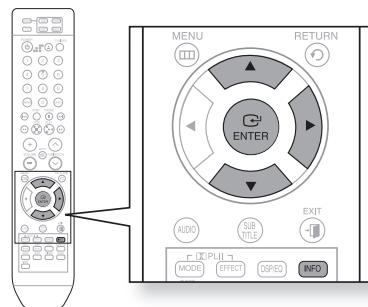

DVD ◀ EN 1/3 OFF/ 02 ↻ A - B
A TO B REPEAT ON

➤ To return to normal playback, press the Cursor **▲, ▼** button to select **OFF**.



- The A-B Repeat function does not operate with DivX, MP3 or JPEG discs.

Step Function



Press the **STEP** button.

- The picture moves forward one frame each time the button is pressed during playback.

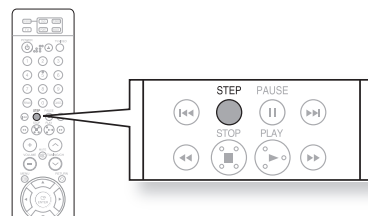





- No sound is heard during step motion playback.



Angle Function

This function allows you to view the same scene in different angles.

1. Press the **INFO** button.
2. Press the Cursor **▶** button to move to **ANGLE** () display.
3. Press the Cursor **▲**, **▼** button or numeric buttons to select the desired angle.
 - Each time the button is pressed, the angle changes as follows:

 1/3 →  2/3 →  3/3 →  1/3

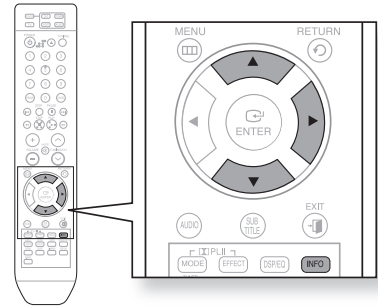

- The Angle function works only with discs on which multiple angles have been recorded.

Zoom (Screen Enlarge) Function



This function allows you to enlarge a particular area of the displayed image.

1. Press the **ZOOM** button.
2. Press the Cursor **▲**, **▼**, **◀**, **▶** button to move to the area you want to enlarge.
3. Press the **ENTER** button.
 - Each time the button is pressed, the zoom level changes as follows:

ZOOM X 1.5 → **ZOOM X 2** → **ZOOM X 3**
→ **ZOOM OFF**

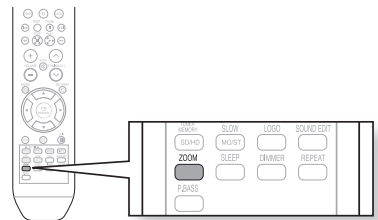

USING THE PLAYBACK FUNCTION

Bonus Group



Some DVD-Audio discs have an extra 'bonus' group that requires a 4-digit key number to access. See the disc packaging for details and the key number.

When you play a DVD-Audio disc that has a bonus group, the key number input screen appears automatically.

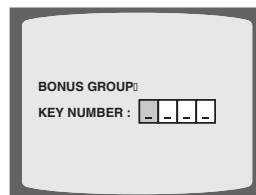

- If you eject the disc, switch the power off, or unplug the player, you will need to re-enter the key number.

Navigating Pages



During playback, press the ∇ , \blacktriangle button on the remote control.

- You can select the desired image from a DVD-Audio disc containing still images.
- With some discs, you may not be able to select images.

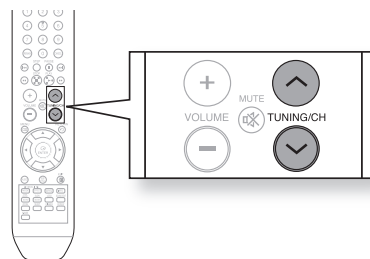

Audio Language Selection Function



1. Press the **INFO** button twice.
2. Press the Cursor **▲, ▼** button or numeric buttons to select the desired audio language.
 - Depending on the number of languages on a DVD disc, a different audio language (ENGLISH, SPANISH, FRENCH, etc.) is selected each time the button is pressed.

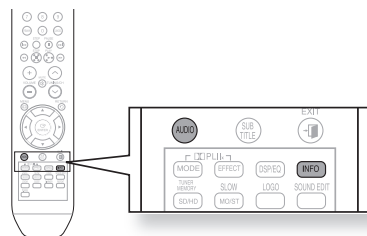

EN 1/3 → SP 2/3 → FR 3/3 → EN 1/3

Subtitle Language Selection Function



1. Press the **INFO** button twice.
2. Press the Cursor **▶** button to move to **SUBTITLE** (📄) display.
3. Press the Cursor **▼** button or numeric buttons to select the desired subtitle.

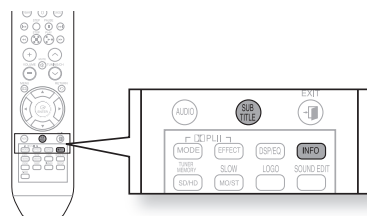

EN 01/03 → SP 02/03 → FR 03/03 → OFF/03 →

EN 01/03



- To operate this function, you can also press the **AUDIO** or **SUBTITLE** buttons on the remote control.
- Depending on the disc, the Subtitle and Audio Language functions may not be available.

Moving Directly to a Scene/Song



1. Press the **INFO** button.
2. Press the Cursor **▲, ▼** button or numeric buttons to select the desired title/track (📄) and then press the **ENTER** button.
3. Press the Cursor **◀, ▶** button to move to the Chapter (🌀) display.
4. Press the Cursor **▲, ▼** button or numeric buttons to select the desired chapter and then press the **ENTER** button.
5. Press the Cursor **◀, ▶** button to move to time (🕒) display.
6. Press the numeric buttons to select the desired time and then press the **ENTER** button.

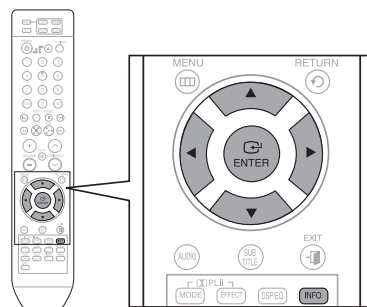

playback

USING THE PLAYBACK FUNCTION

Moving Directly to a Scene/Song



Press the **numeric** buttons.

- The selected file will be played.
- When playing an MP3 or JPEG disc, you cannot use the Cursor **▲, ▼** button to move to a folder.
To move a folder, press the **STOP** (■) and then press the Cursor **▲, ▼** button.

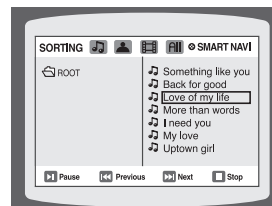

- You can press the **◀◀, ▶▶** button on the remote control to move directly to the desired title, chapter, or track.
- Depending on the disc, you may not be able to move to the selected title or time.

Using the Disc Menu



You can use the menus for the audio language, subtitle language, profile, etc.

DVD menu contents differ from disc to disc.

1. In Stop mode, press the **MENU** button.
2. Press the Cursor **▲, ▼** button or numeric buttons to move to **Disc Menu** and then press the **ENTER** button.
 - When you select Disc Menu and it is not supported by the disc, the "**This menu is not supported**" message appears on the screen.
3. Press the Cursor **▲, ▼, ◀, ▶** button to select the desired item.
4. Press the **ENTER** button.

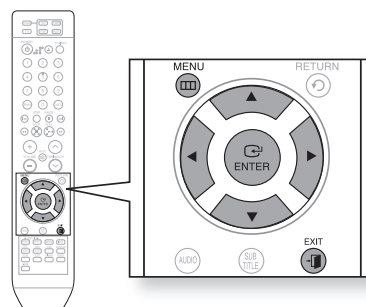

➤ Press the **EXIT** button to exit the setup screen.



- The disc menu display may be different depending on the disc.

Using the Title Menu

For DVDs containing multiple titles, you can view the title of each movie. Depending on the disc, the availability of this feature may vary.

1. In Stop mode, press the **MENU** button.
2. Press the Cursor **▲**, **▼** button to move to **Title Menu**.
3. Press the **ENTER** button.
 - The title menu appears.

➤ Press the **EXIT** button to exit the setup screen.

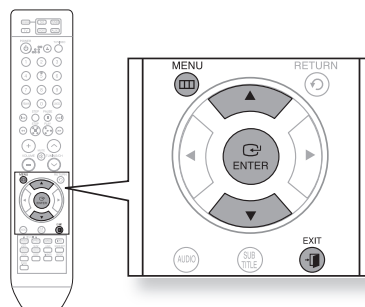

- The Title menu display may be different depending on the disc.

playback

USING THE iPod

You can enjoy playback of your iPod using the supplied remote control.

1. Place the iPod in the Dock.
 - Your iPod is automatically turned on.
2. Connect the dock connector for iPod to the iPod jack on the DVD home theater.
3. Press the **PORT** button on the remote control to select iPod mode.
 - Each time the button is pressed, your selection will toggle between iPod mode and USB mode.
4. Use **▲, ▼, ◀, ▶** and **ENTER** button on the remote control to display the list of menu.
5. You can use the remote control or main unit to control simple playback functions such as **PLAY, PAUSE, STOP, NEXT/PREV,** and **FF/REW,** and **REPEAT.**

➤ Press the **RETURN** button to return to the previous menu.



Listening by Category

1. Press the **▲, ▼** buttons on the remote control to **select music** and press the **ENTER** button.
 - The **Music** categories appear.
2. Press the **▲, ▼** buttons desired category and press the **ENTER** button.
 - The music files appear.
3. Press the **▲, ▼** buttons to select the file to play and press the **ENTER** button.
 - The music will start with a new screen which shows the song title, time, artist, and progress bar.



- Not all iPods are compatible with this unit.
- This product may not work properly, depending on the software version of iPod. Please download and install the latest software version.
- This product does not support playing photos and movies from your iPod.

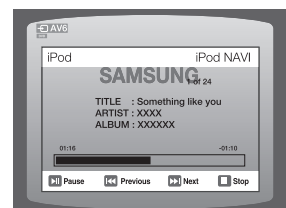
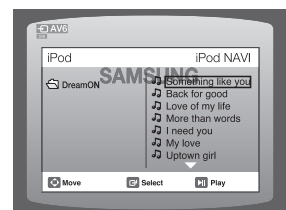
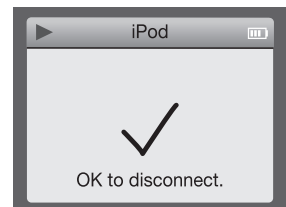

Music categories

File information including the artist name, album name, music title and genre will be displayed according to the ID3 Tag information on the appropriate music file.

Now Playing : Plays a recently played file or moves to the playback screen of the current file.

Artists : To play by artist.

Songs : To play in numeric or alphabetical order

Playlists : To play by Playlist.

Albums : To play by album.

Genres : To play by genre.

Composer : To play by composer.



What is an ID3 Tag?

This is what is attached to an MP3 to carry information relevant to the file such as the title, artist, album, year, genre and a comment field.

PLAYING MEDIA FILES USING THE USB HOST FEATURE

You can enjoy media files such as pictures, movies and music saved on an MP3 player (except iPod), USB memory stick or digital camera in high quality video with 5.1 channel Home Theater sound by connecting the storage device to the USB port of the Home Theater.

1. Connect the USB device to the USB port on the front of the unit.
2. Press the **FUNCTION** button on the DVD Player or the **PORT** button on the remote control to select the USB mode.
 - **USB** appears on the display screen and then disappears.
 - The **USB MENU** screen appears on the TV screen and the saved file is played.
3. To stop playback, press the **STOP** (■) button.

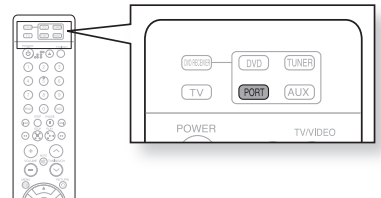
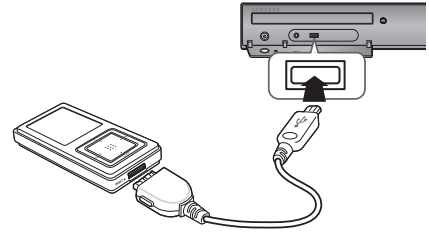

Safe PORT Removal

To prevent damage to the memory stored in the USB device, perform safe removal before disconnecting the USB cable.

- Press the **STOP** (■) button twice in a row. The display will show **REMOVE USB**.
- Remove the USB cable.

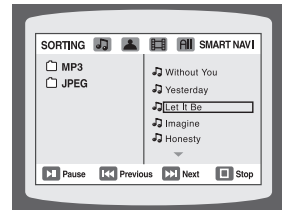

- To listen to your music files with 5.1 channel home theater sound, you must set the Dolby Pro Logic II mode to Matrix. (See page 60)
- In USB mode, you are not enabled to change the resolution or use the **SETUP** menu if there is no USB device connected to the USB port.

Skip Forward/Back

During playback, press the **SKIP FORWARD/BACK** button.

- When there is more than one file and you press the **SKIP FORWARD** button, the next file is selected.
- When there is more than one file and you press the **SKIP BACK** button, the previous file is selected.

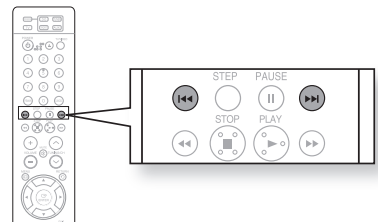

playback

Fast playback

During playback, press the ◀▶ button.

- Each time you press either button, the playback speed will change as follows:

2x → 4x → 8x → 32x → Normal.

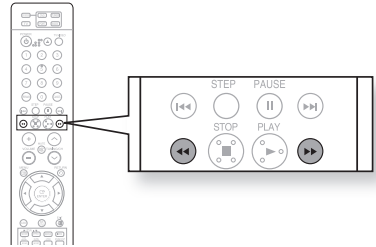

Compatible Devices

1. USB devices that support USB Mass Storage v1.0. (USB devices that operate as a removable disc in Windows (2000 or later) without additional driver installation.)
2. MP3 Player: HDD and flash type MP3 players.
3. Digital camera: Cameras that support USB Mass Storage v1.0.
 - Cameras that operate as a removable disc in Windows (2000 or later) without additional driver installation.
4. USB HDD and USB Flash Drive: Devices that support USB2.0 or USB1.1.
 - You may experience a difference in playback quality when you connect a USB1.1 device.
 - For a USB HDD, make sure to connect an auxiliary power cord to the USB HDD for proper operation.
5. USB card Reader: One slot USB card reader and Multi slot USB card reader.
 - Depending on the manufacturer, the USB card reader may not be supported.
 - If you install multiple memory devices into a multi card reader, you may experience problems.
6. If you use a USB extension cable, the USB device might not be recognized.

Supported Formats

Format	File name	File extension	Bit rate	Version	Pixel	Sampling Frequency
Still Picture	JPG	JPG .JPEG	-	-	640x480	-
Music	MP3	.MP3	80~384kbps	-	-	44.1kHz
	WMA	.WMA	56~128kbps	V8	-	44.1kHz
Movie	WMV	.WMV	4Mbps	V1,V2,V3,V7	720x480	44.1KHz~48KHz
	DivX	.AVI,.ASF	4Mbps	DivX3.11~ DivX5.1, XviD	720x480	44.1KHz~48KHz

- CBI (Control/Bulk/Interrupt) is not supported.
- Digital Cameras that use PTP protocol or require additional program installation when connected to a PC are not supported.
- A device using NTFS file system is not supported. (The system supports only the FAT file system and will not play a movie in larger than 1 GB in USB mode.)
- Some MP3 players, when connected to this product, may not operate depending on the sector size of their file system.
- The USB host function is not supported if a product that transfers media files by its manufacturer-specific program is connected.
- Does not operate with Janus enabled MTP (Media Transfer Protocol) devices.
- **The USB host function of this product does not support all USB devices. For information on supported devices, see page 66.**

system setup

For your convenience, you can set this DVD Home Theater's features for the best use in your home environment.

SETTING THE LANGUAGE

OSD(On-Screen Display) language is set to English by default.

1. In Stop mode, press the **MENU** button.
2. Press the Cursor **▼** button to move to **Setup** and then press the **ENTER** button.
3. Select **Language** and then press the **ENTER** button.
4. Press the Cursor **▲,▼** button to select **OSD Language** and then press the **ENTER** button.
5. Press the Cursor **▲,▼** button to select the desired language and then press the **ENTER** button.
 - Once the setup is complete, the OSD will be English if English has been selected as language.

- Press the **RETURN** button to return to the previous level.
- Press the **EXIT** button to exit the setup screen.

- **OSD LANGUAGE** : Selecting the OSD Language
- **AUDIO** : Selecting the Audio Language (recorded on the disc)
- **SUBTITLE** : Selecting the Subtitle Language (recorded on the disc)
- **DISC MENU** : Selecting the Disc Menu Language (recorded on the disc)
- ※ If the language you selected is not recorded on the disc, menu language will not change even if you set it to your desired language.

- **OTHERS** : To select another language, select OTHERS and enter the language code of your country.
AUDIO, SUBTITLE and DISC MENU languages can be selected.

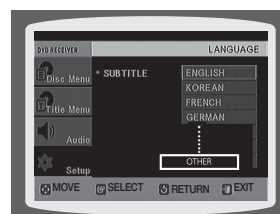
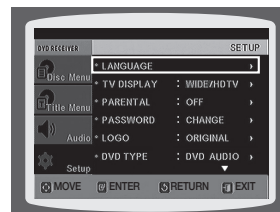

system setup

SETTING TV SCREEN TYPE

Depending on your TV type (Widescreen or conventional 4:3), you can select the TV's aspect ratio.

1. In Stop mode, press the **MENU** button.
 2. Press the Cursor **▼** button to move to **Setup** and then press the **ENTER** button.
 3. Press the Cursor **▼** button to move to **TV DISPLAY** and then press the **ENTER** button.
 4. Press the Cursor **▲,▼** button to select the desired item and then press the **ENTER** button.
 - Once the setup is complete, you will be taken to the previous screen.
- Press the **RETURN** button to return to the previous level.
➤ Press the **EXIT** button to exit the setup screen.

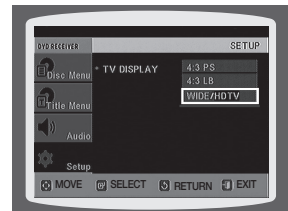
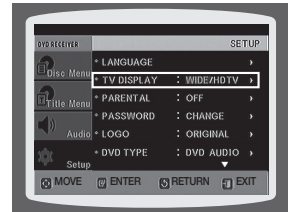

Adjusting the TV Aspect Ratio (Screen Size)

The horizontal to vertical screen size ratio of conventional TVs is 4:3, while that of widescreen and high definition TVs is 16:9. This ratio is called the aspect ratio. When playing DVDs recorded in different screen sizes, you should adjust the aspect ratio to fit your TV or monitor.

For a standard TV, select either **4:3PS** or **4:3LB** option according to personal preference. Select **WIDE/HDTV** if you have a widescreen TV.

4:3PS (4:3 Pan&Scan)

Select this to play a 16:9 picture in the pan & scan mode on a conventional TV.

- You can see the central portion of the screen only (with the sides of the 16:9 picture cut off).



4:3LB (4:3 Letterbox)

Select this to play a 16:9 picture in the letter box mode on a conventional TV.

- Black bars will appear at the top and bottom of the screen.



WIDE/HDTV

Select this to view a 16:9 picture in the full-screen mode on your widescreen TV.

- You can enjoy the widescreen aspect.



- If a DVD is in the 4:3 ratio, you cannot view it in widescreen.
- Since DVD discs are recorded in various image formats, they will look different depending on the software, the type of TV, and the TV aspect ratio setting.
- When using HDMI, the screen is automatically converted to Wide mode.

SETTING PARENTAL CONTROLS (RATING LEVEL)

Use this to restrict playback of adult or violent DVDs you do not want children to view.

1. In Stop mode, press the **MENU** button.
2. Press the Cursor **▼** button to move to **Setup** and then press the **ENTER** button.
3. Press the Cursor **▼** button to move to **PARENTAL** and then press the **ENTER** button.
4. Press the Cursor **▲, ▼** button to select the desired rating level and then press the **ENTER** button.
 - If you have selected Level 6, you cannot view DVDs with Level 7 or higher.
 - The higher the level, the closer the content is to violent or adult material.
5. Enter the password and then press the **ENTER** button.
 - The password is set to "7890" by default.
 - Once the setup is complete, you will be taken to the previous screen.

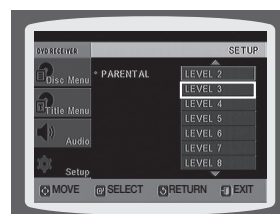
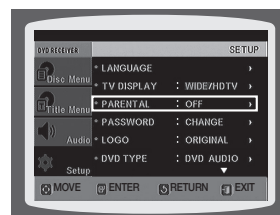

- Press the **RETURN** button to return to the previous level.
- Press the **EXIT** button to exit the setup screen.



- This function works only if a DVD disc contains the rating level information.

SETTING THE PASSWORD

You can set the password for the Parental (rating level) setting.

1. In Stop mode, press the **MENU** button.
2. Press the Cursor **▼** button to move to **Setup** and then press the **ENTER** button.
3. Press the Cursor **▼** button to move to **PASSWORD** and then press the **ENTER** button.
4. Press the **ENTER** button.
5. Enter the password and then press the **ENTER** button.
 - Enter the old password, a new password, and confirm new password.
 - The setting is complete.

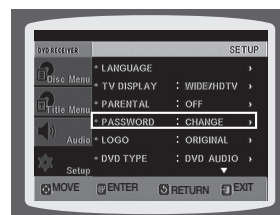

- The password is set to "7890" by default.

If you have forgotten the rating level password, do the following

- While the player is in No Disc mode, hold the DVD Players **STOP** (⏏) button for longer than 5 seconds. **INITIAL** appears on the display and all settings will return to the default values.
- Press the **POWER** button.

Using the RESET function will erase all stored settings.
Do not use this unless necessary.

system setup

SETTING THE WALLPAPER



While watching a DVD or JPEG CD, you can set the image you like as background wallpaper.

1. During playback, press the **PAUSE** button when an image you like appears.
2. Press the **LOGO** button.
 - **COPY LOGO DATA** will be displayed on the TV screen.
3. The power will turn off and then back on.
 - The selected wallpaper will be displayed.
 - You can select up to 3 wallpaper settings.

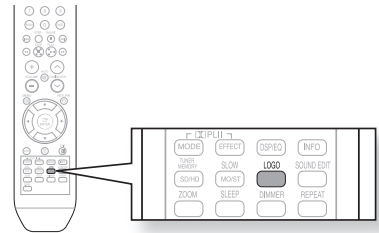

-  This function will not work when the HDMI output is 720p, 1080i or 1080p.

TO SELECT ONE OF THE 3 WALLPAPER SETTINGS YOU'VE MADE

1. In Stop mode, press the **MENU** button.
 2. Press the Cursor **▼** button to move to **Setup** and then press the **ENTER** button.
 3. Press the Cursor **▼** button to move to **LOGO** and then press the **ENTER** button.
 4. Press the Cursor **▲, ▼** button to select the desired **USER**, and then press the **ENTER** button.
 - This selects one of the 3 wallpaper screens.
 5. Press the **EXIT** button to exit the setup screen.
- **ORIGINAL** : Select this to set the Samsung Logo image as your wallpaper.
 - **USER** : Select this to set the desired image as your wallpaper.

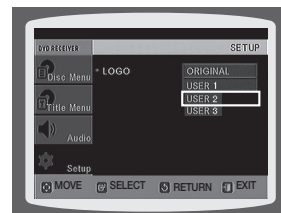

- Press the **RETURN** button to return to the previous level.
- Press the **EXIT** button to exit the setup screen.

DVD PLAYBACK MODE

Some DVD-Audio discs contain DVD-Video as well as DVD-Audio.

To play back the DVD-Video portion of the DVD-Audio disc, set the unit to DVD-Video mode.

1. Press the **MENU** button while the disc tray is open.
2. Press the Cursor **▼** button to move to **Setup** and then press the **ENTER** button.
3. Press the Cursor **▼** button to move to **DVD TYPE** and then press the **ENTER** button.
4. Press the Cursor **▲, ▼** button to move to **DVD VIDEO** and then press the **ENTER** button.
 - Set steps 1 ~ 4 again if you want to switch to DVD AUDIO Play mode.

- **DVD VIDEO** : Set to play the DVD video contents contained on a DVD audio disc.
- **DVD AUDIO** : Set to play the default DVD audio.

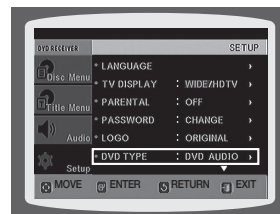

- 
 - DVD Play mode is set to DVD Audio as factory default setting.
 - Powering off the main unit will automatically switch to the DVD Audio mode.

DviX (R) Registration

Please use the Registration code to register this player with the DivX (R) video on demand format.

To learn more, go to www.divx.com/vod.

SETTING THE SPEAKER MODE

Signal outputs and frequency responses from the speakers will automatically be adjusted according to your speaker configuration and whether certain speakers are used or not.

1. In Stop mode, press the **MENU** button.
2. Press the Cursor **▼** button to move to **Audio** and then press the **ENTER** button.
3. In the **SPEAKER SETUP**, press the **ENTER** button again.
4. Press the Cursor **▲, ▼, ◀, ▶** button to move to the desired speaker and then press the **ENTER** button.
 - For C, SL, and SR, each time the button is pressed, the mode switches alternately as follows : SMALL → NONE.
 - For L and R, the mode is set to SMALL.

- **SMALL** : Select this when using the speakers.
- **NONE** : Select this when no speaker is connected.

- Press the **RETURN** button to return to the previous level.
- Press the **EXIT** button to exit the setup screen.

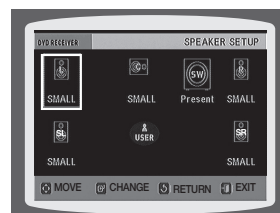
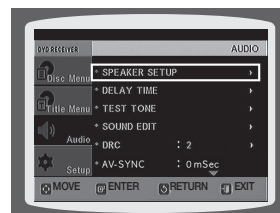

- 
 - Depending on PRO LOGIC and STEREO settings, the speaker mode may vary (see page 60).

system setup

SETTING THE DELAY TIME

If the speakers cannot be placed at equal distances from the listening position, you can adjust the delay time of the audio signals from the center and rear speakers.

1. In Stop mode, press the **MENU** button.
 2. Press the Cursor **▼** button to move to **Audio** and then press the **ENTER** button.
 3. Press the Cursor **▼** button to move to **DELAY TIME** and then press the **ENTER** button.
 4. Press the Cursor **▲, ▼, ◀, ▶** button to move to the desired speaker and then press the **ENTER** button.
 5. Press the Cursor **◀, ▶** to set the Delay time.
 - You can set the delay time for C between 00 and 05mSEC and for SL and SR between 00 and 15mSEC.
- Press the **RETURN** button to return to the previous level.
- Press the **EXIT** button to exit the setup screen.

Setting up the Speaker Delay Time

When 5.1CH Surround Sound is played, you can enjoy the best sound if the distance between you and each speaker is the same.

Since the sounds arrive at the listening position at different times depending on the placement of speakers, you can adjust this difference by adding a delay effect to the sound of the Center and Rear Speakers.

Setting CENTER SPEAKER

If the distance of Dc is equal to or longer than the distance of Df in the figure, set the mode as 0ms. Otherwise, change the setting according to the table.

Distance between Df and Dc	0.00 inch	1 feet, 1.39 inches	2 feet, 2.77 inches	3 feet, 5.73 inches	4 feet, 7.12 inches	5 feet, 9.29 inches
Delay Time	0 ms	1 ms	2 ms	3 ms	4 ms	5 ms

Setting REAR SPEAKER

If the distance of Dc is equal to or longer than the distance of Df in the figure, set the mode as 0ms.

Otherwise, change the setting according to the table.

Distance between Df and Dc	0.00 inch	3 feet, 5.73 inches	6 feet, 11.7 inches	10 feet, 4.80 inches	13 feet, 10.54 inches	17 feet, 4.27 inches
Delay Time	0 ms	3 ms	6 ms	9 ms	12 ms	15 ms

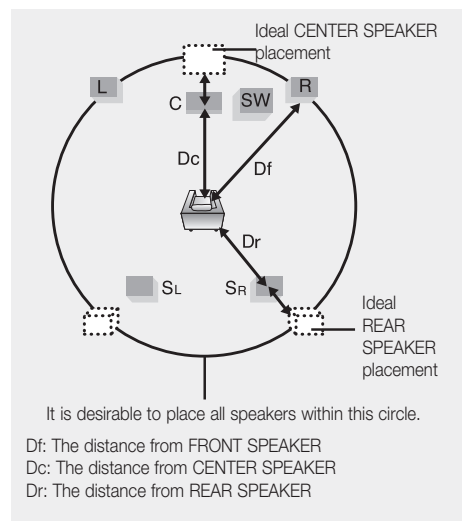

- With **PL II** (Dolby Pro Logic II), the delay time may be different for each mode.
- With AC-3 and DTS, the delay time can be set between 00 and 15mSEC.
- The Center channel is only adjustable on 5.1 channel discs.

SETTING THE TEST TONE

Use the Test Tone feature to check the speaker connections.

1. In Stop mode, press the **MENU** button.
 2. Press the Cursor **▼** button to move to **Audio** and then press the **ENTER** button.
 3. Press the Cursor **▼** button to move to **TEST TONE** and then press the **ENTER** button.
 - The test tone will be sent to **L → C → R → SR → SL → SW** in order.
If the **ENTER** button is pressed again at this time, the test tone will stop.
- Press the **RETURN** button to return to the previous level.
- Press the **EXIT** button to exit the setup screen.

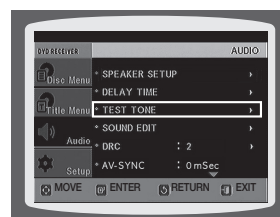

SETTING THE AUDIO

You can adjust the balance and level for each speaker.

1. In Stop mode, press the **MENU** button.
2. Press the Cursor **▼** button to move to **Audio** and then press the **ENTER** button.
3. Press the Cursor **▼** button to move to **SOUND EDIT** and then press the **ENTER** button.
4. Press the Cursor **▲, ▼** button to select and adjust the desired item. Press the Cursor **◀, ▶** button to adjust the settings.

- Press the **RETURN** button to return to the previous level.
- Press the **EXIT** button to exit the setup screen.

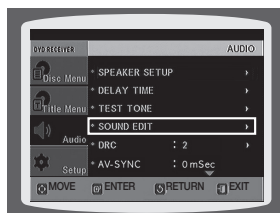

system setup

SETTING THE AUDIO

Manually Adjusting the Speaker Volume and Balance with the SOUND EDIT Button.

Press the **SOUND EDIT** button and then press the Cursor **◀,▶** button.

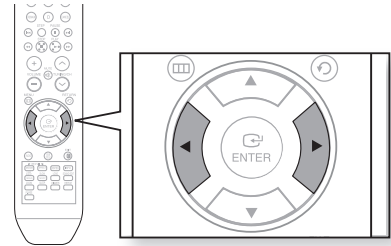

Adjusting Front/Rear Speaker Balance

- You can select between 00, -06, and OFF.
- The volume decreases as you move closer to -6.

Adjusting Center/Rear/Subwoofer Speaker Level

- The volume level can be adjusted in steps from +6dB to -6dB.
- The sound gets louder as you move closer to +6dB and quieter as you get closer to -6dB.

SETTING THE DRC (DYNAMIC RANGE COMPRESSION)

This feature balances the range between the loudest and quietest sounds. You can use this function to enjoy Dolby Digital sound when watching movies at low volume at night.

1. In Stop mode, press the **MENU** button.
 2. Press the Cursor **▼** button to move to **Audio** and then press the **ENTER** button.
 3. Press the Cursor **▼** button to move to **DRC** and then press the **ENTER** button.
 4. Press the Cursor **▲,▼** to adjust the **DRC**.
 - When the Cursor **▲** button is pressed, the effect is greater, and when the Cursor **▼** button is pressed, the effect is smaller.
- Press the **RETURN** button to return to the previous level.
- Press the **EXIT** button to exit the setup screen.

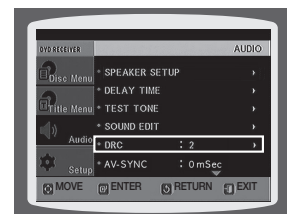

SETTING THE AV SYNC

Video may look slower than the audio if it is connected to a digital TV. If this occurs, adjust the audio delay time to match the video.

1. In Stop mode, press the **MENU** button.
 2. Press the Cursor **▼** button to move to **Audio** and then press the **ENTER** button.
 3. Press the Cursor **▼** button to move to **AV-SYNC** and then press the **ENTER** button.
 4. Press the Cursor **▲, ▼** button to select the AV-SYNC Delay Time and then press the **ENTER** button.
 - You can set the audio delay time between 0 ms and 300 ms. Set it to the optimal status.
- Press the **RETURN** button to return to the previous level.
- Press the **EXIT** button to exit the setup screen.

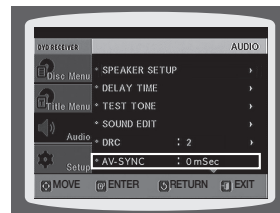

SETTING THE HDMI AUDIO

The audio signals transmitted over the HDMI Cable can be toggled ON/OFF.

1. In Stop mode, press the **MENU** button.
 2. Press the Cursor **▼** button to move to **Audio** and then press the **ENTER** button.
 3. Press the Cursor **▼** button to move to **HDMI AUDIO** and then press the **ENTER** button.
 4. Press the Cursor **▲, ▼** button to select **ON** or **OFF** and then press the **ENTER** button.
- **ON** : Both video and audio signals are transmitted over the HDMI connection cable, and audio is output through your TV speakers only.
 - **OFF** : Video is transmitted over the HDMI connection cable only, and audio is output through the home theater speakers only.
- Press the **RETURN** button to return to the previous level.
- Press the **EXIT** button to exit the setup screen.



- The default setting of this function is HDMI AUDIO OFF.
- HDMI AUDIO is automatically down-mixed to 2ch for TV speakers.

system setup

SOUND FIELD (DSP)/EQ FUNCTION

DSP(Digital Signal Processor) : DSP modes have been designed to simulate different acoustic environments.
EQ : You can select ROCK, POP, or CLASSIC to optimize the sound for the genre of music you are playing

Press the DSP/EQ button.

- **DSP** appears on the display panel.

Each time the button is pressed, the selection changes as follows:

POPS → JAZZ → ROCK → STUDIO → CLUB → HALL → MOVIE → CHURCH → PASS

- **POPS, JAZZ, ROCK** : Depending on the genre of music, you can select POP, JAZZ, and ROCK.
- **STUDIO** : Provides a sense of presence as if in a studio.
- **CLUB** : Simulates the sound of a dance club with a throbbing bass beat.
- **HALL** : Provides a clear vocal as if listening in a concert hall.
- **MOVIE** : Provides the feeling of a movie theater.
- **CHURCH** : Gives the feel of being in a grand church.
- **PASS** : Select this for normal listening.

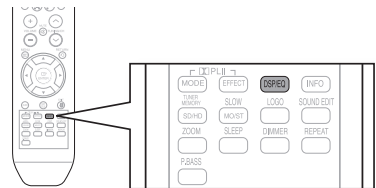

- The DSP/EQ function is only available in STEREO mode. Press the **PL II mode** button to show STEREO on the display.
- This feature works with CDs, MP3-CDs, 2 channel DVD-Audio, DivX and Dolby Digital discs.
- When playing a DVD disc encoded with two or more channels, multi-channel mode will be selected automatically and DSP/EQ function does not work.

DOLBY PRO LOGIC II MODE

You can select the desired Dolby Pro Logic II audio mode.

Press the **PL II MODE** button.

- Each time the button is pressed, the mode changes as follows.

**MUSIC → CINEMA → PRO LOGIC → MATRIX →
STEREO → MUSIC**

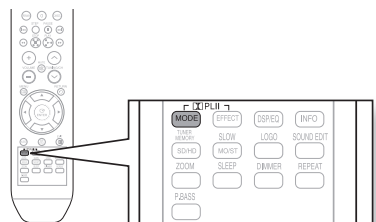

PRO LOGIC II

- **MUSIC** : When listening to music, you can experience sound effects as if you are listening to the actual performance.
- **CINEMA** : Adds realism to the movie soundtrack.
- **PRO LOGIC** : You will experience a realistic multi-channel effect, as if using five speakers, while using just the front left and right speakers.
- **MATRIX** : You will hear 5.1 channel surround sound.
- **STEREO** : Select this to listen to sound from the front left and right speakers and the subwoofer only.



- When selecting Pro Logic II mode, connect your external device to the AUDIO INPUT jacks (L and R) on the player. If you connect to only one of the inputs (L or R), you cannot listen to surround sound.

DOLBY PRO LOGIC II EFFECT

This function works only in Dolby Pro Logic MUSIC mode.

1. Press the **PL II MODE** button to select **MUSIC** mode.
2. Press the **PL II EFFECT** button.
 - Each time the button is pressed, the mode changes as follows.
3. Press the **◀▶** buttons to select the desired effect setting.
 - PANORAMA : You can select either 0 or 1.
 - C- WIDTH : You can select between 0 and 7.
 - DIMENS : You can select between 0 and 6.

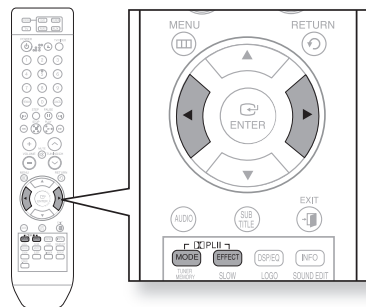

P.BASS

P.BASS function boosts the bass for a more powerful sound.

1. Press the **P.BASS** button to select **P.BASS** mode.
2. Press the P.Bass button again to turn off the P.Bass mode.

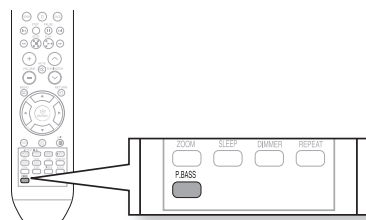

- The P.BASS function is only available with 2 channel LPCM sources such as mp3, Divx, cd and wma. Press P.BASS button and "POWER BASS ON" will be displayed on the screen.
- The P.bass does not work with DSP/EQ or DOLBY PRO LOGIC II modes. If you press P.BASS in the DSP/EQ mode, the DSP/EQ mode is automatically shut off and the P. BASS function comes on.

LISTENING TO RADIO

Remote Control

1. Press the **TUNER** button to select the FM band.
2. Tune in to the desired station.
 - **Automatic Tuning 1** : When the **◀▶** button is pressed, a preset broadcast station is selected.
 - **Automatic Tuning 2** : Press and hold the **▲, ▼** button to automatically search for active broadcasting stations.
 - **Manual Tuning** : Briefly press the **▲, ▼** button to increase or decrease the frequency incrementally.

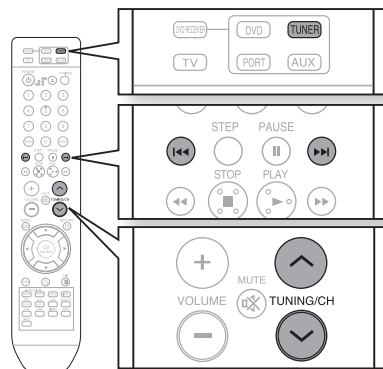

Main Unit

1. Press the **FUNCTION** button to select the FM band.
2. Select a broadcast station.
 - **Automatic Tuning 1** : Press the **STOP** (◻) button to select **PRESET** and then press the **◀▶** button to select the preset station.
 - **Automatic Tuning 2** : Press the **STOP** (◻) button to select **MANUAL** and then press and hold the **◀▶** button to automatically search the band.
 - **Manual Tuning** : Press the **STOP** (◻) button to select **MANUAL** and then briefly press the **◀▶** button to tune in to a lower or higher frequency.

Press the **MO/ST** button to listen in Mono/Stereo.

- Each time the button is pressed, the sound switches between **STEREO** and **MONO**.
- In a poor reception area, select **MONO** for a clear, interference-free broadcast.

PRESETTING STATIONS

Example : Presetting FM 89.10 in the memory

1. Press the **TUNER** button to select the FM band.
2. Press the **▲, ▼** button to select **89.10**.
3. Press the **TUNER MEMORY** button.
4. Press the **◀▶** button to select preset number.
 - You can select between 1 and 15 presets.
5. Press the **TUNER MEMORY** button again.
6. To preset another station, repeat steps 2 to 5.
 - To tune in to a preset station, press the **◀▶** button on the remote control to select a channel.

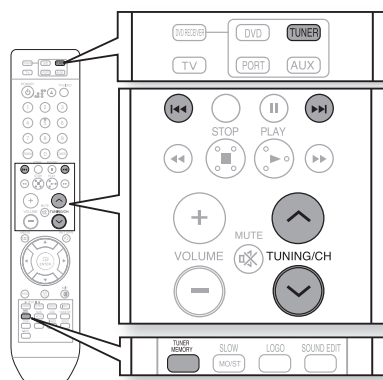

convenient function

SLEEP TIMER FUNCTION

You can set the time that the Home Theater will shut itself off.

Press the **SLEEP** button.

- **SLEEP** will be displayed. Each time the button is pressed, the preset time changes as follows :
10 → 20 → 30 → 60 → 90 → 120 → 150 → OFF.

To confirm the sleep timer setting, press the **SLEEP** button.

- The remaining time before the Home Theater will shut itself off is displayed.
- Pressing the button again changes the sleep time from what you have set earlier.

To cancel the sleep timer, press the **SLEEP** button until **OFF** appears on the display.

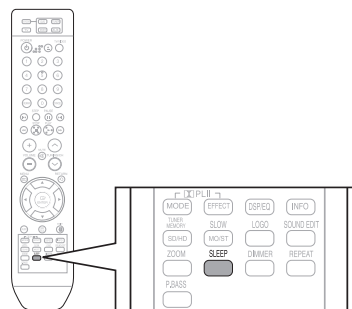

ADJUSTING DISPLAY BRIGHTNESS

You can adjust the brightness of the display on the main unit so it won't interfere with your movie viewing.

Press the **DIMMER** button.

- Each time the button is pressed, the brightness of front display will be adjusted.

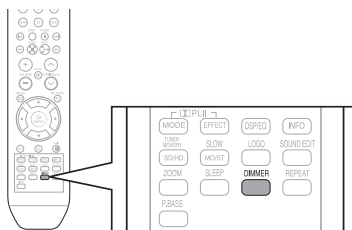

MUTE FUNCTION

This is useful when answering a doorbell or telephone call.

Press the **MUTE** button.

- **MUTE** appears in the display.
- To restore the sound, press the **MUTE** button again.

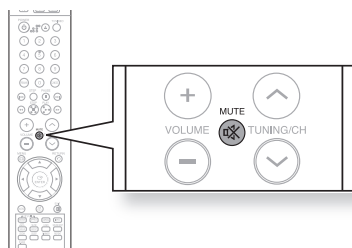

troubleshooting

Refer to the chart below when this unit does not function properly. If the problem you are experiencing is not listed below or if the instruction below does not help, turn off the unit, disconnect the power cord, and contact the nearest authorized dealer or Samsung Electronics Service Center.

SYMPTOM	Check/Remedy
Disc tray does not open.	<ul style="list-style-type: none"> • Is the power cord plugged securely into the outlet? • Turn off the power and then turn it back on.
'Please connect your ipod' appears on the screen.	<ul style="list-style-type: none"> • Remove the iPod from the docking cradle and reinsert again. • If the battery level of your iPod is totally drained, you have to charge it again before use.
Playback does not start immediately when the Play/Pause button is pressed.	<ul style="list-style-type: none"> • Are you using a deformed disc or a disc with scratches on the surface? • Wipe the disc clean.
Sound is not produced.	<ul style="list-style-type: none"> • No sound is heard during fast playback, slow playback, and step motion playback. • Are the speakers connected properly? Is the speaker setup correctly customized? • Is the disc severely damaged?
Sound can be heard only from a few speakers and not all six.	<ul style="list-style-type: none"> • When listening to a CD or radio, sound is output to the front speakers (L/R) only. Select "PRO LOGIC II" by pressing  PL II (Dolby Pro Logic II) on the remote control to use all six speakers. • Make sure that the DVD disc is 5.1-CH compatible. • If you set C, SL, and SR to NONE in the speaker mode in the audio setup of the setup screen, no sound is heard from the center speaker and the front left and right speakers. Set C, SL, and SR to SMALL.
Dolby Digital 5.1 CH Surround Sound is not produced.	<ul style="list-style-type: none"> • Is there "Dolby Digital 5.1 CH" mark on the disc? Dolby Digital 5.1 CH Surround Sound is produced only if the disc is recorded with 5.1 channel sound. • Is the audio language correctly set to DOLBY DIGITAL 5.1-CH in the information display?
The remote control does not work.	<ul style="list-style-type: none"> • Is the remote control being operated within its operation range of angle and distance? • Are the batteries exhausted? • Have you selected the mode(TV/DVD) functions of the remote control (TV or DVD) correctly?

SYMPTOM	Check/Remedy
<ul style="list-style-type: none"> • Disc is rotating but no picture is produced. • Picture quality is poor and picture is shaking. 	<ul style="list-style-type: none"> • Is the TV power on? • Are the video cables connected properly? • Is the disc dirty or damaged? • A poorly manufactured disc may not be playable.
<p>Audio language and subtitles do not work.</p>	<ul style="list-style-type: none"> • Audio language and subtitles will not work if the disc does not contain them.
<p>Menu screen does not appear even when the menu function is selected.</p>	<ul style="list-style-type: none"> • Are you using a disc that does not contain menus?
<p>Aspect ratio cannot be changed.</p>	<ul style="list-style-type: none"> • You can play 16:9 DVDs in 16:9 WIDE mode, 4:3 LETTER BOX mode, or 4:3 PAN SCAN mode, but 4:3 DVDs can be seen in 4:3 ratio only. Refer to the DVD disc jacket and then select the appropriate function.
<ul style="list-style-type: none"> • The main unit is not working. (Example: The power goes out or strange noise is heard.) • The DVD player is not working normally. 	<ul style="list-style-type: none"> • Turn off the power and hold the STOP (■) button on the main unit for longer than 5 seconds (reset function). <p>Using the RESET function will erase all stored settings. Do not use this unless necessary.</p>
<p>The password for rating level has been forgotten.</p>	<ul style="list-style-type: none"> • While “NO DISC” message appears on the display of main unit, hold the main unit's STOP (■) button for longer than 5 seconds. “INITIAL” appears on the display and all settings will return to the default values. • Press the POWER button. <p>Using the RESET function will erase all stored settings. Do not use this unless necessary.</p>
<p>Can't receive radio broadcast.</p>	<ul style="list-style-type: none"> • Is the antenna connected properly? • If the antenna's input signal is weak, install an external FM antenna in an area with good reception.

USB host feature supported products

DIGITAL CAMERA

Product	Company	Type	Product	Company	Type
Finepix-A340	Fuji	Digital Camera	U300	Olympus	Digital Camera
Finepix-F810	Fuji	Digital Camera	X-350	Olympus	Digital Camera
Finepix-F610	Fuji	Digital Camera	C-760	Olympus	Digital Camera
Finepix-f450	Fuji	Digital Camera	C-5060	Olympus	Digital Camera
Finepix S7000	Fuji	Digital Camera	X1	Olympus	Digital Camera
Finepix A310	Fuji	Digital Camera	U-mini	Olympus	Digital Camera
KD-310Z	Konica	Digital Camera	Lumix-FZ20	Panasonic	Digital Camera
Finecam SL300R	Kyocera	Digital Camera	DMC-FX7GD	Panasonic	Digital Camera
Finecam SL400R	Kyocera	Digital Camera	Lumix LC33	Panasonic	Digital Camera
Finecam S5R	Kyocera	Digital Camera	LUMIX DMC-F1	Panasonic	Digital Camera
Finecam Xt	Kyocera	Digital Camera	Optio-S40	Pentax	Digital Camera
Dimage-Z1	Minolta	Digital Camera	Optio-S50	Pentax	Digital Camera
Dimage Z1	Minolta	Digital Camera	Optio 33LF	Pentax	Digital Camera
Dimage X21	Minolta	Digital Camera	Optio MX	Pentax	Digital Camera
Coolpix4200	Nikon	Digital Camera	Digimax-420	Samsung	Digital Camera
Coolpix4300	Nikon	Digital Camera	Digimax-400	Samsung	Digital Camera
Coolpix 2200	Nikon	Digital Camera	Sora PDR-T30	Toshiba	Digital Camera
Coolpix 3500	Nikon	Digital Camera	Coolpix 5900	Nikon	Digital Camera
Coolpix 3700	Nikon	Digital Camera	Coolpix S1	Nikon	Digital Camera
Coolpix 4100	Nikon	Digital Camera	Coolpix 7600	Nikon	Digital Camera
Coolpix 5200	Nikon	Digital Camera	DMC-FX7	Panasonic	Digital Camera
Stylus 410 digital	Olympus	Digital Camera	Dimage Xt	Minolta	Digital Camera
300-digital	Olympus	Digital Camera	AZ-1	Olympus	Digital Camera
300-digital	Olympus	Digital Camera			

USB FLASH DISC

Product	Company	Type	Product	Company	Type
Cruzer Micro	Sandisk	USB 2.0 USB Flash Drive 128M	XTICK	LG	USB 2.0 128M
Cruzer Mini	Sandisk	USB 2.0 128M	Micro Mini	lomega	USB 2.0 128M
Cruzer Mini	Sandisk	USB 2.0 256M	iFlash	Imation	USB 2.0 64M
SONY Micro Vault	Sony	USB 2.0 64MB	LG	XTICK(M)	USB 2.0 64M
FLEX DRIVE	Serotech	USB 2.0 32MB	RiDATA	EZDrive	USB 2.0 64M
AnyDrive	A.L tech	USB 2.0 128MB			

MP3 PLAYER

Product	Company	Type	Product	Company	Type
Creative MuVo NX128M	Creative	128 MB MP3 Player	YP-K3	Samsung	MP3 Player
Iriver H320	Iriver	20G HDD MP3 Player	YP-U3	Samsung	MP3 Player
YH-920	Samsung	20G HDD MP3 Player	YP-Z5F	Samsung	MP3 Player
YP-T7	Samsung	MP3 Player	iAUDIO U2	Cowon	MP3 Player
YP-MT6	Samsung	MP3 Player	iAUDIO G3	Cowon	MP3 Player
YP-T6	Samsung	MP3 Player	iAudio M3	Cowon	HDD MP3 Player
YP-T9	Samsung	MP3 Player	SI-M500L	Sharp	256MB MP3 Player
YP-ST5	Samsung	MP3 Player	H10	Iriver	MP3 Player
YP-T5	Samsung	MP3 Player	YP-T10	Samsung	MP3 Player
YP-K5	Samsung	MP3 Player	YP-P2	Samsung	MP3 Player

appendix



CAUTIONS ON HANDLING AND STORING DISCS

Small scratches on the disc may reduce sound and picture quality or cause skipping.
Be especially careful not to scratch discs when handling them.

Handling discs

Do not touch the playback side of the disc.
Hold the disc by the edges so that fingerprints will not get on the surface.
Do not stick paper or tape on the disc.

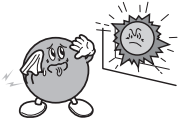
Disc Storage

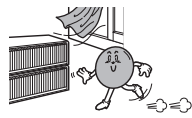
Do not keep in direct sunlight	Keep in a cool ventilated area	Keep in a clean Protection jacket. Store vertically.
		



- Do not allow the discs to become contaminated with dirt.
- Do not load cracked or scratched discs.

Handling and Storing Discs

When you get fingerprints or dirt on the disc, clean it with a mild detergent diluted in water and wipe with a soft cloth.

- When cleaning, wipe gently from the inside to the outside of the disc



- Condensation may form if warm air comes into contact with cold parts inside the player. When condensation forms inside the player, the player may not operate correctly. If this occurs, remove the disc and let the player stand for 1 or 2 hours with the power on.

appendix

SPECIFICATIONS

General	Power Requirements	AC 120V, 60Hz
	Power Consumption	80 W
	Weight	7.9 lbs
	Dimensions	16.9 (W) x 2.6 (H) x 13.6 (D) inches
	Operating Temperature Range	+41°F to +95°F
	Operating Humidity Range	10 % to 75 %
Disc	DVD (Digital Versatile Disc)	Reading Speed : 3.49 ~ 4.06 m/sec. Approx. Play Time (Single Sided, Single Layer Disc) : 135 min.
	CD : 5 inches (COMPACT DISC)	Reading Speed : 4.8 ~ 5.6 m/sec. Maximum Play Time : 74 min.
	CD : 3 1/2 inches (COMPACT DISC)	Reading Speed : 4.8 ~ 5.6 m/sec. Maximum Play Time : 20 min.
Video Output	Composite Video	480i 1 channel : 1.0 Vp-p (75 Ω load)
	Component Video	480i Y : 1.0 Vp-p (75 load) Pr : 0.70 Vp-p (75 Ω load) Pb : 0.70 Vp-p (75 Ω load)
Video/Audio	HDMI	1080p, 1080i, 720p, 480p
Amplifier	Front speaker output	166W x 2(3Ω)
	Center speaker output	166W (3Ω)
	Rear speaker output	166W x 2(3Ω)
	Subwoofer speaker output	170W(3Ω)
	Frequency range	20Hz~20KHz
	S/N Ratio	70dB
	Channel separation	60dB
	Input sensitivity	(AUX)400mV

HT-Z310

Speaker	Speaker system	5.1 ch speaker system	
		Front/Rear/Center	Subwoofer
	Impedance	3 Ω	3 Ω
	Frequency range	140Hz~20KHz	45Hz~160Hz
	Output sound pressure level	86dB/W/M	86dB/W/M
	Rated input	166W	170W
	Maximum input	332W	340W
	Dimensions (W x H x D)	Front/Rear : 3.5 x 5.39 x 3.6 inches Center : 11.8 x 4.0 x 3.6 inches Subwoofer : 7.1 x 12.6 x 15.0 inches	
	Weights	Front : 1.3 lbs, Rear : 1.1 lbs, Center : 2.0 lbs Subwoofer : 10.0 lbs	

HT-TZ312

Speaker	Speaker system	5.1 ch speaker system		
		Front/Rear	Center	Subwoofer
	Impedance	3 Ω	3 Ω	3 Ω
	Frequency range	160Hz~20KHz	160Hz~20KHz	45Hz~170Hz
	Output sound pressure level	86dB/W/M	86dB/W/M	88dB/W/M
	Rated input	166W	166W	170W
	Maximum input	332W	332W	340W
	Dimensions (W x H x D)	Front : 3.5 x 40.1 x 3.6 inches (Stand : 11.0 x 11.0) Rear : 3.5 x 5.4 x 3.6 inches Center : 11.8 x 4.0 x 3.6 inches Subwoofer : 7.1 x 12.6 x 15.0 inches		
	Weights	Front : 6.6 lbs, Center : 1.9 lbs Rear : 1.0 lbs, Subwoofer : 10.0 lbs		

*: Nominal specification

- Samsung Electronics Co., Ltd reserves the right to change the specifications without notice.
- Weight and dimensions are approximate.



SAMSUNG

LIMITED WARRANTY TO ORIGINAL PURCHASER

Samsung Electronics Canada Inc.(SECA), warrants that this product is free from defective material and workmanship.

SECA further warrants that if this product fails to operate properly within the specified warranty period and the failure is due to improper workmanship or defective materials, SECA will repair or replace the product at its option.

All warranty repairs must be performed by a SECA Authorized Service Center. (The name and address of the location nearest you can be obtained by calling toll free: 1- 800- SAMSUNG)

LABOR

One year (Carry- in)

PARTS

One year

On carry-in models, transportation to and from the service center is the customer's responsibility.

The original dated sales receipt must be retained by the customer and is the only acceptable proof of purchase. It must be presented to the authorized service center at the time service is requested.

EXCLUSIONS (WHAT IS NOT COVERED)

This warranty does not cover damage due to accident, fire, flood and/ or other acts of God; misuse, incorrect line voltage, improper installation, improper or unauthorized repairs, commercial use or damage that occurs in shipping. Exterior and interior finish, lamps, glass are not covered under this warranty. Customer adjustments which are explained in the instruction manual are not covered under the terms of this warranty. This warranty will automatically be voided for any unit found with a missing or altered serial number. This warranty is valid only on products purchased and used in Canada.

**HEADQUARTERS
SAMSUNG ELECTRONICS CANADA INC.,
CUSTOMER SERVICE
55 STANDISH COURT MISSISSAUGA, ONTARIO L5R 4B2 CANADA
FABRIQUE EN CORÉE
1-800-SAMSUNG (1-800-7267864)
WWW.SAMSUNG.COM/CA**

Contact SAMSUNG WORLD WIDE

If you have any questions or comments relating to Samsung products, please contact the SAMSUNG customer care center.

Region	Country	Customer Care Center ☎	Web Site
North America	CANADA	1-800-SAMSUNG(726-7864)	www.samsung.com/ca
	MEXICO	01-800-SAMSUNG(726-7864)	www.samsung.com
	U.S.A	1-800-SAMSUNG(726-7864)	www.samsung.com
Latin America	ARGENTINE	0800-333-3733	www.samsung.com/ar
	BRAZIL	0800-124-421 , 4004-0000	www.samsung.com
	CHILE	800-SAMSUNG(726-7864)	www.samsung.com/cl
	NICARAGUA	00-1800-5077267	
	HONDURAS	800-7919267	
	COSTA RICA	0-800-507-7267	www.samsung.com/latin
	ECUADOR	1-800-10-7267	www.samsung.com/latin
	EL SALVADOR	800-6225	www.samsung.com/latin
	GUATEMALA	1-800-299-0013	www.samsung.com/latin
	JAMAICA	1-800-234-7267	www.samsung.com/latin
	PANAMA	800-7267	www.samsung.com/latin
	PUERTO RICO	1-800-682-3180	www.samsung.com/latin
	REP. DOMINICA	1-800-751-2676	www.samsung.com/latin
	TRINIDAD & TOBAGO	1-800-SAMSUNG(726-7864)	www.samsung.com/latin
	VENEZUELA	0-800-100-5303	www.samsung.com/latin
COLOMBIA	01-8000112112	www.samsung.com.co	
Europe	BELGIUM	0032 (0)2 201 24 18	www.samsung.com/be
	CZECH REPUBLIC	844 000 844 Distributor pro Českou republiku: Samsung Zrt., česká organizační složka Vyskočilova 4, 14000 Praha 4	www.samsung.com/cz
	DENMARK	70 70 19 70	www.samsung.com/dk
	FINLAND	030-6227 515	www.samsung.com/fi
	FRANCE	3260 SAMSUNG (€ 0,15/Min), 08 25 08 65 65 (€ 0,15/Min)	www.samsung.com
	GERMANY	01805 - SAMSUNG(726-7864) (€ 0,14/Min)	www.samsung.com
	HUNGARY	06-80-SAMSUNG(726-7864)	www.samsung.com
	ITALIA	800-SAMSUNG(726-7864)	www.samsung.com
	LUXEMBURG	0035 (0)2 261 03 710	www.samsung.com/be
	NETHERLANDS	0900-SAMSUNG(726-7864) (€ 0,10/Min)	www.samsung.com/nl
	NORWAY	815-56 480	www.samsung.com/no
	POLAND	0 801 801 881 , 022-607-93-33	www.samsung.com/pl
	PORTUGAL	80820-SAMSUNG(726-7864)	www.samsung.com/pt
	SLOVAKIA	0800-SAMSUNG(726-7864)	www.samsung.com/sk
	SPAIN	902 10 11 30	www.samsung.com
	SWEDEN	0771-400 200	www.samsung.com/se
	U.K	0845 SAMSUNG (7267864)	www.samsung.com
	EIRE	0818 717 100	www.samsung.com/ie
	AUSTRIA	0800-SAMSUNG(726-7864)	www.samsung.com/at
	SWITZERLAND	0800-SAMSUNG(726-7864)	www.samsung.com/ch
CIS	RUSSIA	8-800-555-55-55	www.samsung.com
	KAZAHSTAN	8-10-800-500-55-500	www.samsung.kz
	UZBEKISTAN	8-10-800-500-55-500	www.samsung.uz
	KYRGYZSTAN	00-800-500-55-500	
	TADJIKISTAN	8-10-800-500-55-500	
	UKRAINE	8-800-502-0000	www.samsung.com
	LITHUANIA	8-800-77777	www.samsung.lt
	LATVIA	800-7267	www.samsung.com/lv
ESTONIA	800-7267	www.samsung.ee	
Asia Pacific	AUSTRALIA	1300 362 603	www.samsung.com
	NEW ZEALAND	0800SAMSUNG(726-7864)	www.samsung.com/nz
	CHINA	800-810-5858 , 010-6475 1880	www.samsung.com
	HONG KONG	3698-4698	www.samsung.com/hk
	INDIA	3030 8282 , 1800 110011	www.samsung.com
	INDONESIA	0800-112-8888	www.samsung.com
	JAPAN	0120-327-527	www.samsung.com/jp
	MALAYSIA	1800-88-9999	www.samsung.com/my
	PHILIPPINES	1800-10-SAMSUNG(726-7864)	www.samsung.com/ph
	SINGAPORE	1800-SAMSUNG(726-7864)	www.samsung.com
	THAILAND	1800-29-3232 , 02-689-3232	www.samsung.com
	TAIWAN	0800-329-999	www.samsung.com/tw
VIETNAM	1 800 588 889	www.samsung.com	
Middle East & Africa	TURKEY	444 77 11	www.samsung.com
	SOUTH AFRICA	0860-SAMSUNG(726-7864)	www.samsung.com
	U.A.E	800-SAMSUNG (726-7864), 8000-4726	www.samsung.com

Free Manuals Download Website

<http://myh66.com>

<http://usermanuals.us>

<http://www.somanuals.com>

<http://www.4manuals.cc>

<http://www.manual-lib.com>

<http://www.404manual.com>

<http://www.luxmanual.com>

<http://aubethermostatmanual.com>

Golf course search by state

<http://golfingnear.com>

Email search by domain

<http://emailbydomain.com>

Auto manuals search

<http://auto.somanuals.com>

TV manuals search

<http://tv.somanuals.com>