



DIGITAL HOME THEATER SYSTEM

HT-DB390

SAMSUNG ELECTRONICS CANADA, INC.

HEADQUARTERS

7037 Financial Drive, Mississauga, Ontario, Canada L5N 6R3
TEL: 1-905-542-3535
www.samsung.ca

SERVICE DIVISION

7037 Financial Drive, Mississauga, Ontario, Canada L5N 6R3
1-800-SAMSUNG (1-800-726-7864)



ELECTRONICS

Instruction Manual

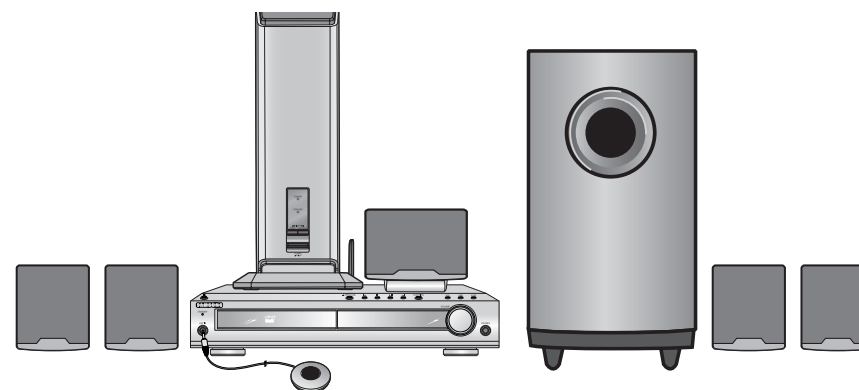

AH68-01445S



Safety Warnings

Precautions

**CLASS 1 LASER PRODUCT
 KLASSE 1 LASER PRODUKT
 LUOKAN 1 LASER LAITE
 KLAS 1 LASER APPARAT
 PRODUCTO LASER CLASE 1**

Note to CATV system installer :
 This reminder is provided to call the CATV system installer's attention to Section 820~40 of the NEC which provides guidelines for proper grounding and, in particular, specifies that the cable ground shall be connected to the grounding system of the building, as close to the point of cable entry as practical



CAUTION:
 TO REDUCE THE RISK OF ELECTRIC SHOCK, DO NOT REMOVE REAR COVER. NO USER SERVICEABLE PARTS INSIDE. REFER SERVICING TO QUALIFIED SERVICE PERSONNEL.

CLASS 1 LASER PRODUCT

This Compact Disc player is classified as a CLASS 1 LASER product.

Use of controls, adjustments or performance of procedures other than those specified herein may result in hazardous radiation exposure.

CAUTION-INVISIBLE LASER RADIATION WHEN OPEN AND INTERLOCKS DEFEATED, AVOID EXPOSURE TO BEAM.



This symbol indicates that dangerous voltage which can cause electric shock is present inside this unit.



This symbol alerts you to important operating and maintenance instructions accompanying the unit.

WARNING: To reduce the risk of fire or electric shock, do not expose this appliance to rain or moisture.

CAUTION: TO PREVENT ELECTRIC SHOCK, MATCH WIDE BLADE OF PLUG TO WIDE SLOT, FULLY INSERT.

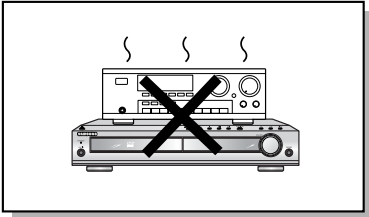
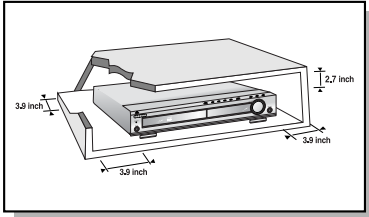

Ensure that the AC power supply in your house complies with the identification sticker located on the back of your player. Install your player horizontally, on a suitable base (furniture), with enough space around it for ventilation (3~4-inches). Make sure the ventilation slots are not covered. Do not stack anything on top of the player. Do not place the player on amplifiers or other equipment which may become hot. Before moving the player, ensure the disc tray is empty. This player is designed for continuous use. Switching off the DVD player to the stand-by mode does not disconnect the electrical supply. In order to disconnect the player completely from the power supply, remove the main plug from the wall outlet, especially when left unused for a long period of time.

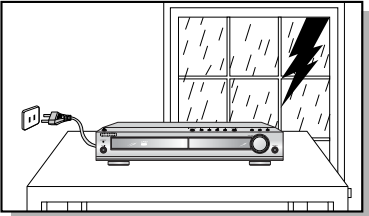

During thunderstorms, disconnect AC main plug from the wall outlet. Voltage peaks due to lightning could damage the unit.

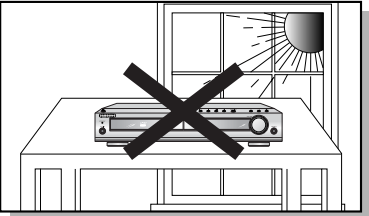

Do not expose the unit to direct sunlight or other heat sources. This could lead to overheating and malfunction of the unit.

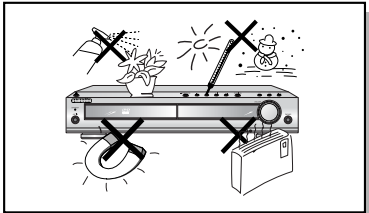

Protect the player from moisture(i.e. vases), and excess heat(e.g. fireplace) or equipment creating strong magnetic or electric fields (i.e. speakers...). Disconnect the power cable from the AC supply if the player malfunctions. Your player is not intended for industrial use. Use of this product is for personal use only. Condensation may occur if your player or disc have been stored in cold temperatures. If transporting the player during the winter, wait approximately 2 hours until the unit has reached room temperature before using.

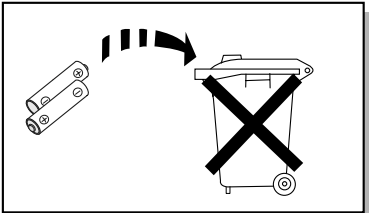

The battery used with this product contain chemicals that are harmful to the environment. Do not dispose of batteries in the general household trash.



Features

● Multi-Disc Playback & AM/FM Tuner

The HT-DB390 combines the convenience of multi-disc playback capability, including DVD, VCD, CD, MP3-CD, CD-R/RW, and DVD-R/RW, with a sophisticated AM/FM tuner, all in a single player.

● Built-in 5.1-Channel Amplifier

The HT-DB390 comes with a built-in 5.1-channel amplifier, allowing you to enjoy dynamic sound.

● Super Digital Sound Master

Equipped with a new digital audio technology (Auto Sound Calibration, Magic Sound Field, and Magic Headphone) developed in cooperation with DiMagic Co., Ltd. in Japan, you'll enjoy a more lively and sensitive sound.



● Wireless Rear Speakers and Amp

The HT-DB390 has a rear surround wireless amp that removes the need for long speaker cables between the main unit and rear speakers.

● Sound Logo

When power is turned on, a sound logo is output from the speakers to notify the user that the unit is optimized for disc playback.

● TV Screen Saver Function

The HT-DB390 automatically brightens and darkens the brightness of the TV screen after 3 minutes in the stop mode.

The HT-DB390 automatically switches itself into the power saving mode after 20 minutes in the screen saver mode.

● Power Saving Function

The HT-DB390 automatically shuts itself off after 20 minutes in the stop mode.

● P.SCAN(Progressive Scan) Function

Unlike regular Interlace Scan, in which two fields of picture information alternate to create the entire picture (odd scan lines, then even scan lines), Progressive Scan uses one field of information (all lines displayed in one pass) to create a clear and detailed picture without visible scan lines.

● Customized TV Screen Display

The HT-DB390 allows you to select your favorite image during JPEG, DVD playback and set it as your background wallpaper.

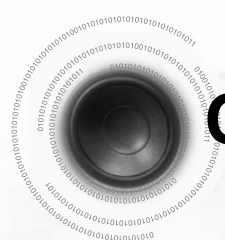

Contents

● PREPARATION

Safety Warnings.....	1
Precautions.....	2
Features.....	3
Notes on Discs.....	5
Description.....	7

● CONNECTIONS

Connecting the Speakers.....	11
Connecting the Video Out to TV.....	15
P.SCAN(Progressive Scan) Function.....	16
Connecting External Components.....	17
Connecting the Antennas.....	19
Before Using Your DVD Player.....	21

● OPERATION

Disc Playback.....	23
MP3-CD Playback.....	24
JPEG Disc Playback.....	25
Displaying Disc Information.....	26
Fast/Slow Playback.....	27
Skipping Scenes/Songs.....	28
Repeat Playback.....	29
A-B Repeat Playback.....	30
Angle Function.....	31
Zoom Function.....	32
Selecting Audio/Subtitle Language.....	33
Moving Directly to a Scene/Song.....	34
Using Disc Menu.....	35
Using the Title Menu.....	36

● SETUP

Setting the Language.....	37
Setting TV Screen type.....	39
Setting Parental Controls (Rating Level).....	41
Setting the Password.....	43
Setting the Wallpaper.....	45
Setting the Speaker Mode.....	47
Setting the Test Tone.....	48
Setting the Delay Time.....	49
Setting the Audio Quality.....	51
Setting the DRC (Dynamic Range Compression).....	53
Auto Sound Calibration Setup.....	55
Live Surround Mode.....	57
Dolby Pro Logic II Mode.....	59
Dolby Pro Logic II Effect.....	60

● RADIO OPERATION

Listening to Radio.....	61
Presetting Stations.....	62

● MISCELLANEOUS

Convenient Functions.....	63
Operating a TV with the Remote Control.....	65
Before Calling for Service.....	67
Cautions on Handling and Storing Discs.....	69
Specifications.....	70
Notes on Terminology.....	71
Warranty.....	72



Notes on Discs



DVD (Digital Versatile Disc) offers fantastic audio and video, thanks to Dolby Digital surround sound and MPEG-2 video compression technology. Now you can enjoy these realistic effects in the home, as if you were in a movie theater or concert hall.



DVD players and the discs are coded by region. These regional codes must match in order for the disc to play. If the codes do not match, the disc will not play.

The Region Number for this player is given on the rear panel of the player. (Your DVD player will only play DVDs that are labeled with identical region codes.)



Playable Discs

Disc Type	Mark (Logo)	Recorded Signals	Disc Size	Max. Playing Time
DVD		Audio + Video	5"	Approx. 240 min. (single-sided) Approx. 480 min. (double-sided)
			3 1/2"	Approx. 80 min. (single-sided) Approx. 160 min. (double-sided)
VIDEO-CD		Audio + Video	5"	74 min.
			3 1/2"	20 min.
AUDIO-CD		Audio	5"	74 min.
			3 1/2"	20 min.



Do not use the following types of disc!

- LD, CD-G, CD-I, CD-ROM and DVD-ROM cannot be played on this player. If such discs are played, a "WRONG DISC FORMAT" message appears on the TV screen.
- DVD discs purchased abroad may not play on this player. If such discs are played, a "WRONG REGION CODE" message appears on the TV screen.

Copy Protection

- Many DVD discs are encoded with copy protection. Because of this, you should only connect your DVD player directly to your TV, not to a VCR. Connecting to a VCR results in a distorted picture from copy-protected DVD discs.
- This product incorporates copyright protection technology that is protected by methods claims of certain U.S. patents and other intellectual property rights owned by Macrovision Corporation and other rights owners. Use of this copyright protection technology must be authorized by Macrovision Corporation, and is intended for home and other limited viewing uses only unless otherwise authorized by Macrovision Corporation. Reverse engineering or disassembly is prohibited.

Disc Recording Format

CD-R Discs

- Depending on the disc recording device (CD-Recorder or PC) and the condition of the disc, some CD-R discs may not be playable.
- Use a 650MB/74 minute CD-R. Avoid CD-R media, as they may not be playable.
- If possible, do not use CD-RW (Rewritable) media, as they may not be playable.
- Only CD-Rs that are properly "closed" can be fully played. If the session is closed but the disc is left open, you may not be able to fully play the disc.

CD-R MP3 Discs

- Only CD-R discs with MP3 files in ISO 9660 or Joliet format can be played.
- MP3 file names should be 8 characters or less in length and contain no blank spaces or special characters (. / = +).
- Use discs recorded with a compression/decompression data rate greater than 128Kbps.
- Only files with the ".mp3" and ".MP3" extensions can be played.
- Only a consecutively written Multisession disc can be played. If there is a blank segment in the Multisession disc, the disc can be played only up to the blank segment.
- If the disc is not closed, it will take longer to begin playback and not all of the recorded files may be played.
- For files encoded in Variable Bit Rate (VBR) format, i.e. files encoded in both low bit rate and high bit rate (e.g., 32Kbps ~ 320Kbps), the sound may skip during playback.
- If more than 500 tracks are recorded on a single CD, a maximum of 500 tracks can be played.
- If more than 300 folders are recorded on a single CD, a maximum of 300 folders can be played.

CD-R JPEG Discs

- Only files with the ".jpeg" and ".JPEG" extensions can be played.
- If the disc is not closed, it will take longer to start playing and not all of the recorded files may be played.
- Only CD-R discs with JPEG files in ISO 9660 or Joliet format can be played.
- JPEG file names should be 8 characters or less in length and contain no blank spaces or special characters (. / = +).
- Only a consecutively written multisession disc can be played. If there is a blank segment in the multisession disc, the disc can be played only up to the blank segment.
- A maximum of 9,999 images can be stored on a single CD.
- When playing a Kodak/Fuji Picture CD, only the JPEG files in the picture folder can be played.
- Picture discs other than Kodak/Fuji Picture CDs may take longer to start playing or may not play at all.



Description

—Front Panel—

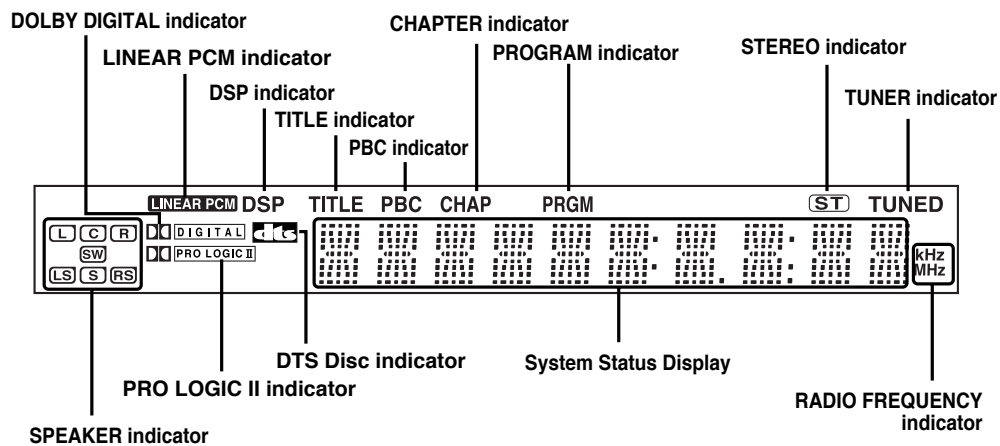
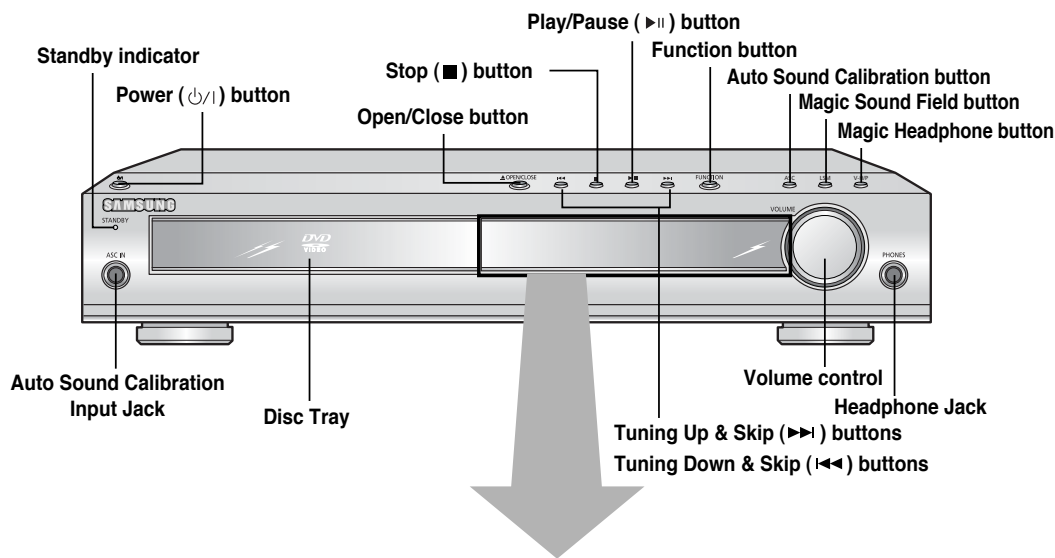

—Rear Panel—

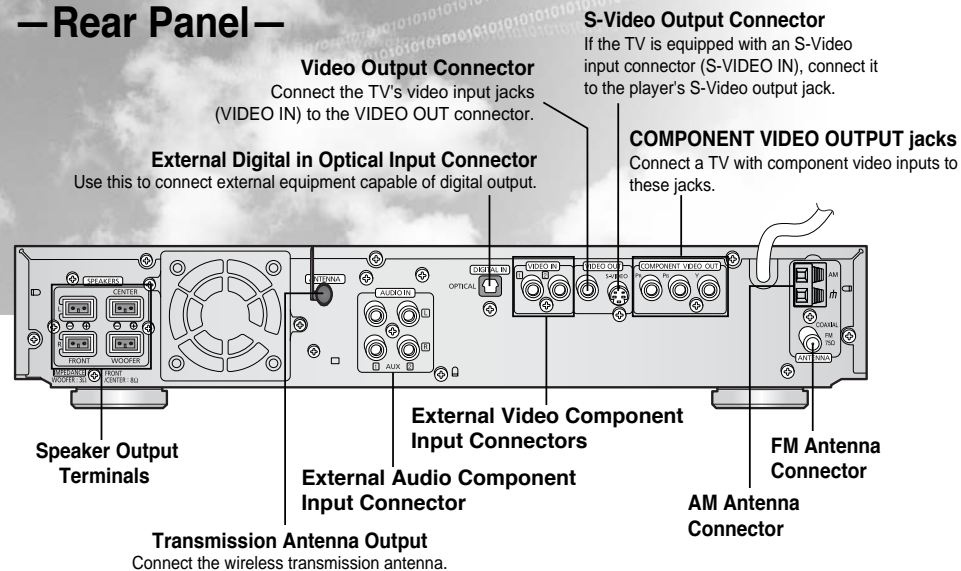

Accessories

* The wireless receiving antenna is built into the wireless rear amplifier.

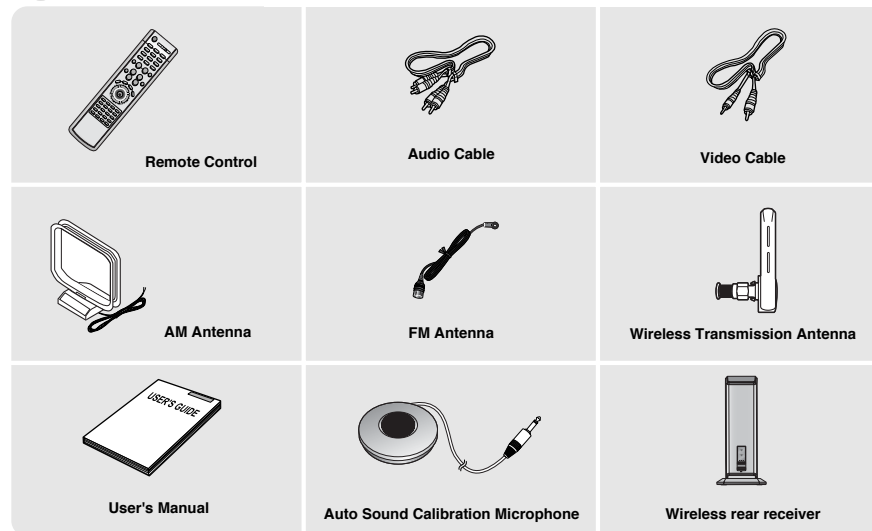



Description

—Remote Control—

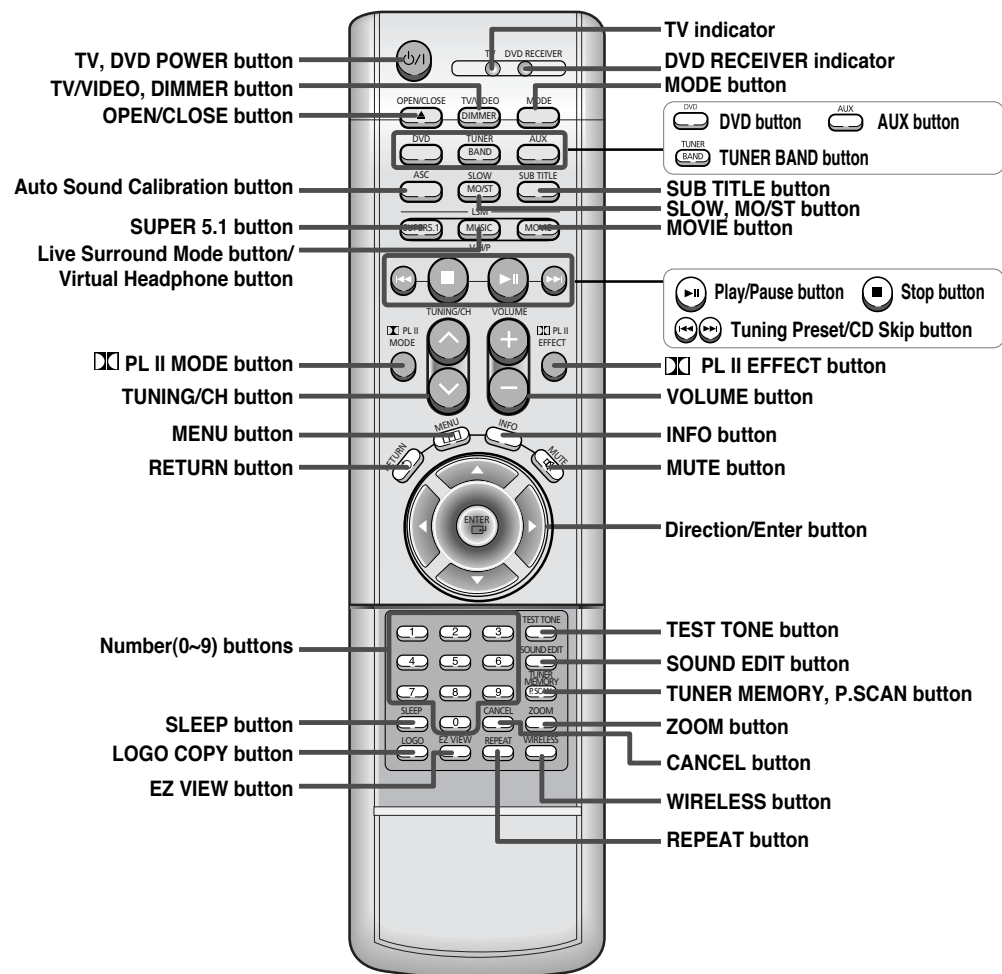

Insert Remote Batteries

- 1 Remove the battery cover on the back of the remote by pressing down and sliding the cover in the direction of the arrow.
- 2 Insert two 1.5V AAA batteries, paying attention to the correct polarities (+ and -).
- 3 Replace the battery cover.

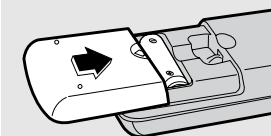
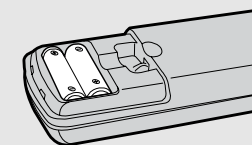
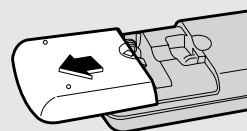

- Caution** Follow these precautions to avoid leaking or cracking cells:
- Place batteries in the remote control so they match the polarity:(+) to (+)and (-)to (-).
 - Use the correct type of batteries.Batteries that look similar may differ in voltage.
 - Always replace both batteries at the same time.
 - Do not expose batteries to heat or flame.

Range of Operation of the Remote Control

The remote control can be used up to approximately 23 feet/7 meters in a straight line. It can also be operated at a horizontal angle of up to 30° from the remote control sensor.

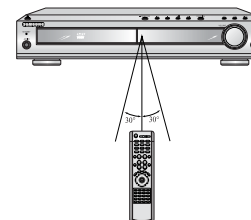

To open the remote control cover, push the top of the cover, then slide downward.

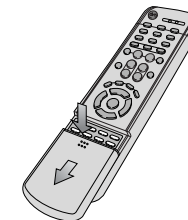



Connecting the Speakers

Before moving or installing the product, be sure to turn off the power and disconnect the power cord.

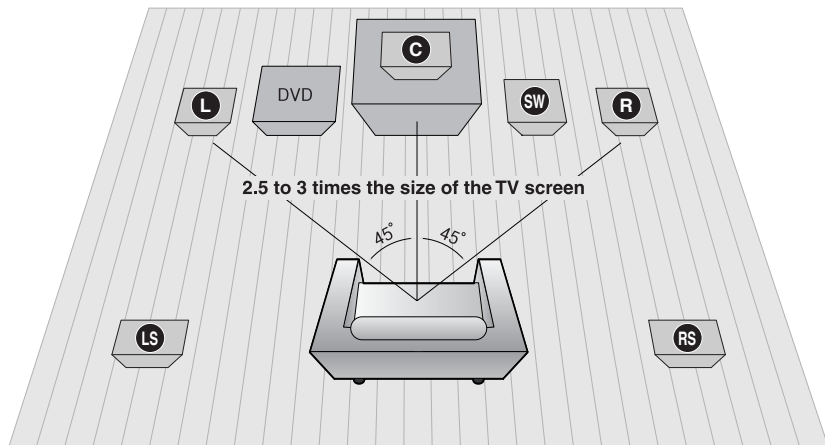

Position of the DVD Player

- Place it on a stand or cabinet shelf, or under the TV stand.

Front Speakers **L R**

- Place these speakers in front of your listening position, facing inwards (about 45°) toward you.
- Place the speakers so that their tweeters will be at the same height as your ear.
- Align the front face of the front speakers with the front face of the center speaker or place them slightly in front of the center speakers.

Center Speaker **C**

- It is best to install it at the same height as the front speakers.
- You can also install it directly over or under the TV.

Selecting the Listening Position

The listening position should be located about 2.5 to 3 times the distance of the TV's screen size away from the TV. Example: For 32" TVs 2-2.4m (6-8 feet)
For 55" TVs 3.5-4m (11-13 feet)

Rear Speakers **LS RS**

- Place these speakers behind your listening position.
- If there isn't enough room, place these speakers to face each other.
- Place them about 60 to 90cm (2 to 3 feet) above your ear, facing slightly downward.

* Unlike the front and center speakers, the rear speakers are used to handle mainly sound effects and sound will not come from them all the time.

Subwoofer **SW**

- The position of the subwoofer is not so critical. Place it anywhere you like.
- Usually, it is placed by a corner near the front speakers.

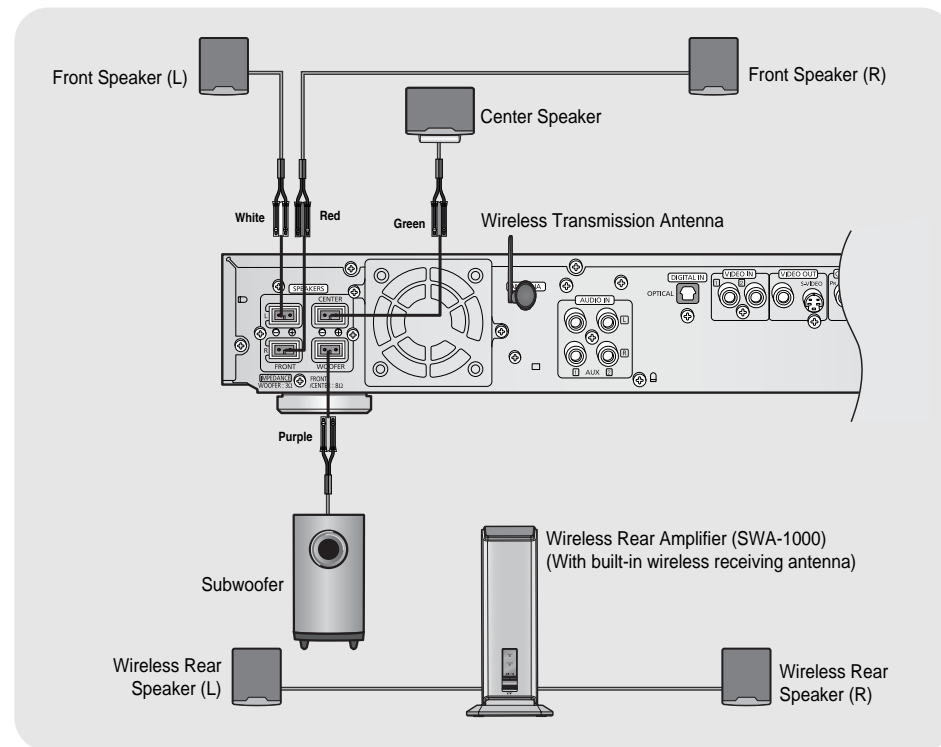

Back of the Speakers

- Press down the terminal tab on the back of the speaker.



- Insert the wire into the terminal and release the terminal tab.

- Insert the black wire into the black (-) terminal and the gray wire into the gray (+) terminal.
- Make sure the polarities (+ and -) are correct.

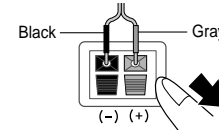

Back of the Main Unit

- Connect the connecting plugs to the back of the DVD player.

- Make sure the colors of the speaker terminals match the colors of the connecting plugs.

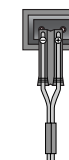

Connecting Wireless Rear Speakers

1 Connect your pair of wireless rear speakers, (L) and (R), to the wireless rear amplifier.

2 Insert the power plug into an outlet, and then press the **POWER** button on the front panel.

- The Power Standby indicator will light up.
- To turn off the wireless rear amplifier, press the **POWER** button in Standby mode.

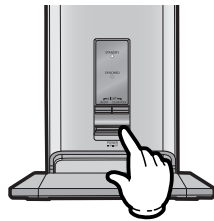
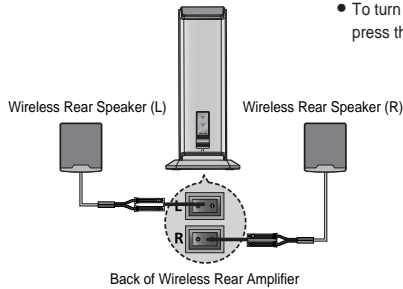

Caution

- Do not connect the wireless rear speakers to the speaker outputs on the back of the main unit. Malfunction may result.
- The wireless receiving antenna is built into the wireless rear amplifier. Keep the unit away from water and moisture.
- For optimal listening performance, make sure that the area around the proposed wireless rear amplifier location is clear of any obstructions.

When using the wireless transmission antenna

Stand the wireless transmission antenna to face upward for best communication status.

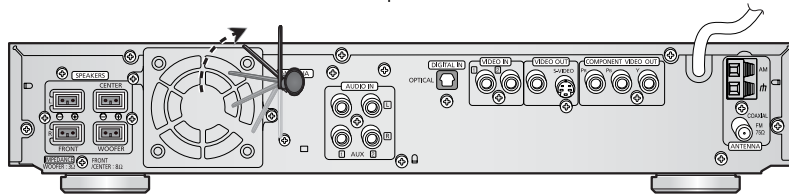

Caution

- Do not apply a strong shock to the wireless transmission antenna. Breakage may result.
- Do not touch the wireless transmission antenna during operation. Noise or interference to communications may result.

Note

- Place the wireless rear amplifier at the rear of the listening position. If the wireless rear amplifier is too close to the main unit, some sound interruption may be heard due to interference.
- If you use a device such as a microwave oven, wireless LAN Card, Bluetooth equipment, or any other device that uses the same frequency (2.4GHz) near the system, some sound interruption may be heard due to interference.
- The transmission distance of radio wave is about 33 feet but may vary depending on your operating environment. If a steel-concrete wall or metallic wall is between the main unit and the wireless rear amplifier, the system may not operate at all because the radio wave cannot penetrate metal.

Resetting Wireless Communication

Reset the system if a communication failure occurs, or if the synchronizing signal indicator does not light up and the "REAR CHK" message blinks on the main unit's display.

Reset the system while the main unit and the wireless rear amplifier (SWA-1000) are in Power Standby mode.

1 With the main unit turned off, press and hold the remote control's **WIRELESS** button for 4 seconds.

- Press the button until the volume control indicator lights up blue. (The indicator will turn off in 1 second.)

2 With the wireless rear amplifier turned on, use a ball point pen or a pair of tweezers to press the **RESET** button on the back of the unit 2 to 3 times.

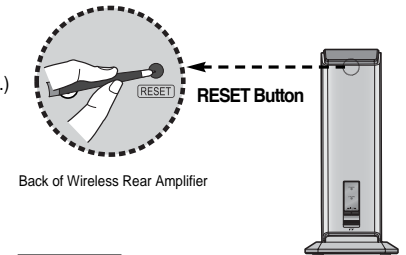

3 Turn on the main unit.

- The wireless rear amplifier's synchronizing signal indicator will light up.
- If Power Standby mode continues, repeat Steps 1 to 3 above.

Caution

- Sound will be heard from the wireless rear speakers in DVD 5.1-CH or Dolby Pro Logic II mode only.
- In 2-CH mode, no sound will be heard from the wireless rear speakers.

Turning On the Mood Light

You can turn the mood light on the wireless rear amplifier on or off, as well as change the light to one of 7 different colors according to your preference.

1 Press the **POWER** button on the wireless amplifier.

- The Power Standby indicator on the front panel will light up and the mood light will turn on.

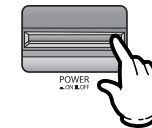

2 Press the **COLOR MODE** button.

- Each time the button is pressed, the color changes as follows: **Blue** → **Light Green** → **Red** → **Sky Blue** → **Yellow** → **Pink** → **White**.



Turning Off the Mood Light

- In **Power Standby mode**, press the **ON/OFF** button on the **Wireless amp**. The mood light will light up or turn off with the last color selected.

Turning off the Wireless Amp and Mood Light

- Press the **POWER** button on the **wireless amp**. The wireless rear amplifier and the mood light will turn off. When the wireless amp is powered on again, the mood light will be blue.

Connecting the Video Out to TV

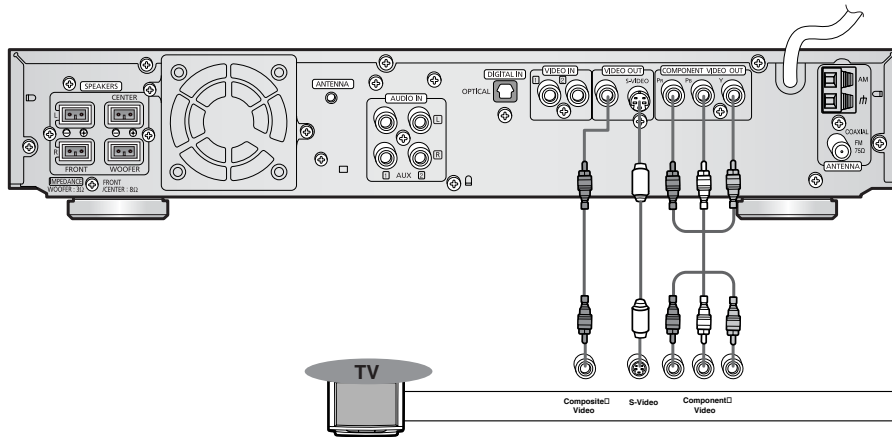

* Depending on your TV, Component Video input jacks may be marked as DVD Video input.

Composite Video (Good Quality)

Connect the supplied video cable from the VIDEO OUT jack on the back panel of the system to the VIDEO IN jack on your television.

S-Video (Better Quality)

If your television is equipped with an S-Video input, connect an S-Video cable (not supplied) from the S-VIDEO OUT jack on the back panel of the system to the S-VIDEO IN jack on your television.

Component Video (Best Quality)

If your television is equipped with Component Video inputs, connect a component video cable (not supplied) from the Pr, Pb and Y jacks on the back panel of the system to the corresponding jacks on your television.

Note • When the Progressive scan mode is selected, the VIDEO and S-VIDEO outputs do not feed any signal. See page 18 to select Progressive Scan.

P.SCAN(Progressive Scan) Function

Unlike regular Interlace Scan, in which two fields of picture information alternate to create the entire picture (odd scan lines, then even scan lines), Progressive Scan uses one field of information (all lines displayed in one pass) to create a clear and detailed picture without visible scan lines.

While the player is in the Stop mode, hold the P.SCAN button down for longer than 5 seconds.

- The selection switches back and forth between "P.SCAN" and "I.SCAN" each time the button is held down for a minimum of 5 seconds.

What is Progressive (or Non-Interlaced) Scanning?

Interlaced Scan (1 FRAME = 2 FIELDS)

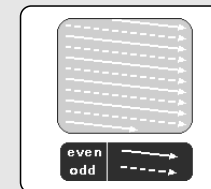

In interlaced-scan video, a frame consists of two interlaced fields (odd and even), where each field contains every other horizontal line in the frame. The odd field of alternating lines is displayed first, and then the even field is displayed to fill in the alternating gaps left by the odd field to form a single frame. One frame, displayed every 1/30th of a second, contains two interlaced fields, thus a total of 60 fields are displayed every 1/60th of a second. The interlaced scanning method is intended for capturing a still object.

Progressive Scan (FULL FRAME)

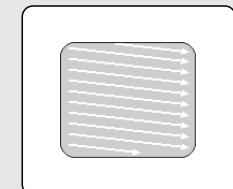

The progressive scanning method scans one full frame of video consecutively down the screen, line by line. An entire image is drawn at one time, as opposed to the interlaced scanning process by which a video image is drawn in a series of passes. The progressive scanning method is desirable for dealing with moving objects.

- Note**
- This function works only on TVs equipped with component video inputs (Y, Pr, Pb) that support Progressive Video. (It does not work on TVs with conventional component inputs, i.e., non-progressive scan TVs.)
 - Depending on the brand and model of your TV, this function may not work.

TV Broadcast System

- This device is designed to work with the NTSC video format.
- For normal playback, the video format a DVD disc is recorded in must coincide with your TV's video format.



Connecting External Components

Connecting an External Digital Component

Example: Digital signal components such as a Settop Box or CD Recorder.

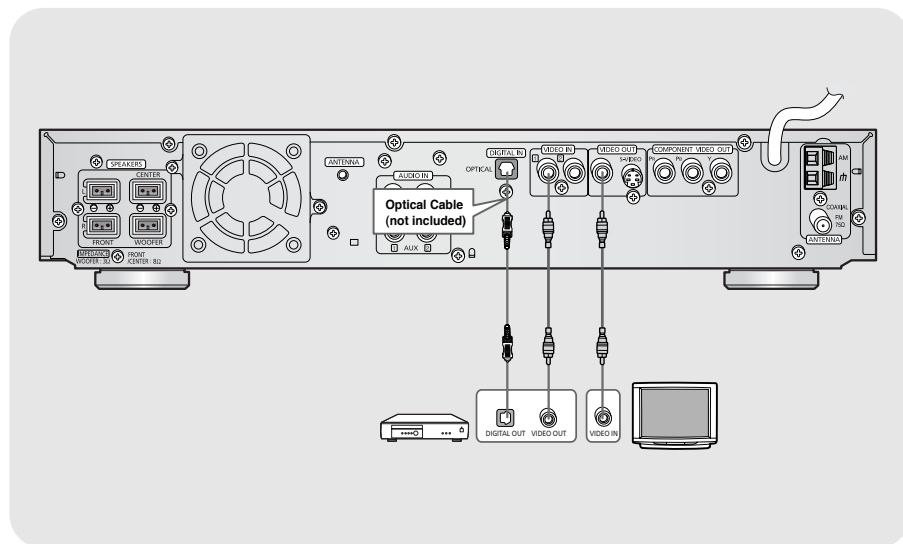

- 1 Connect Video Out on the DVD player to Video In on the TV.
- 2 Connect the Digital Input (OPTICAL) to the Digital Output on the external digital component.
- 3 Press **AUX** on the remote control to select 'DIGITAL IN'.
 - Each time the button is pressed, the selection changes as follows: DIGITAL IN → AUX 1 → AUX 2.
 - You can also use the **FUNCTION** button on the main unit. The mode switches as follows: DVD/CD → DIGITAL IN → AUX1 → AUX2 → FM → AM.

Connecting an External Analog Component

Example: Analog signal components such as a VCR or TV.

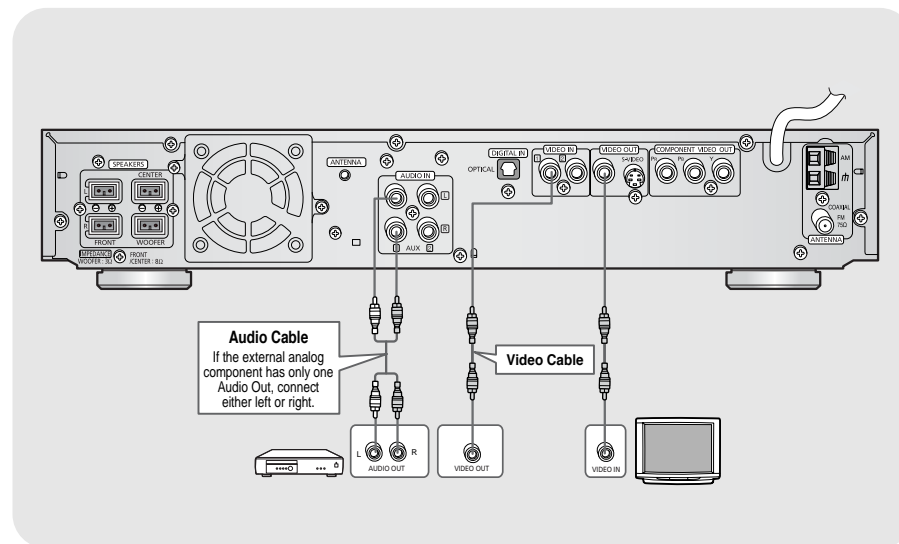

- 1 Connect Video Out on the DVD player to Video In on the TV.
- 2 Connect Video In on the DVD player to Video Out on the external analog component.
- 3 Connect Audio In on the DVD player to Audio Out on the external analog component.
 - Be sure to match connector colors.
- 4 Press **AUX** on the remote control to select AUX 1 or AUX 2.
 - Each time the button is pressed, the selection changes as follows: DIGITAL IN AUX 1 AUX 2.
 - You can also use the **FUNCTION** button on the main unit. The mode switches as follows: DVD/CD → DIGITAL IN → AUX1 → AUX2 → FM → AM.

Note

- If you have connected an external digital component and Video In (1, 2) at the same time, there will be video from AUX 1 even when you select DIGITAL IN.
- If you have connected Audio In (L, R) to 1, connect Video In to 1 as well, and if you have connected Audio In (L, R) to 2, connect Video In to 2 also.



Connecting the Antennas

FM antenna connection

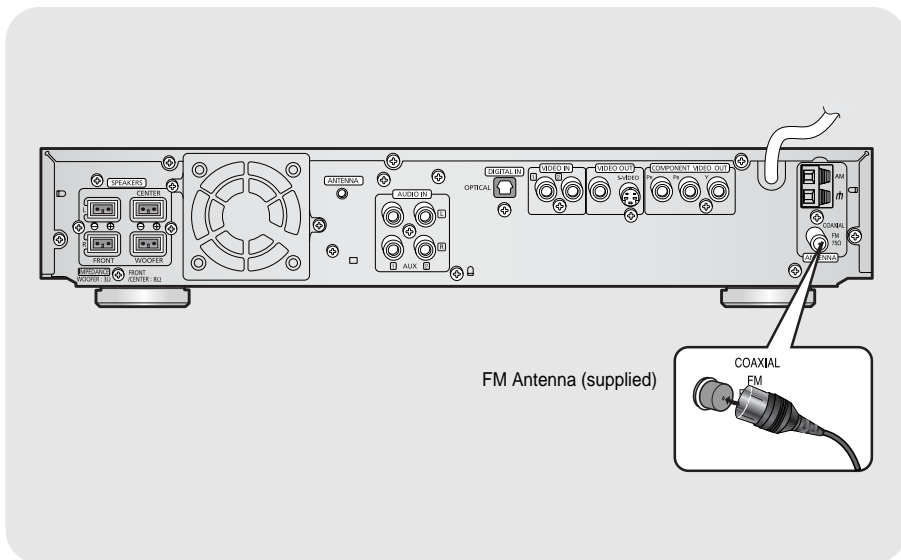

- 1 Connect the FM antenna supplied to the FM 75Ω COAXIAL terminal as a temporary measure.
- 2 Slowly move the antenna wire around until you find a location where reception is good, then fasten it to a wall or other rigid surface.

AM antenna connection

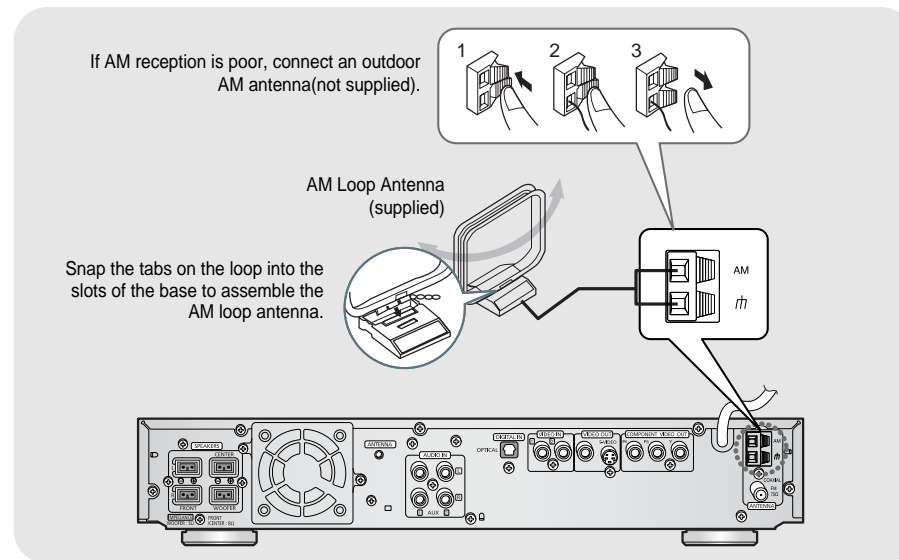

- 1 Connect the AM loop antenna supplied to the AM and *m* terminals.
- 2 If reception is poor, connect an outdoor single vinyl-covered wire to the AM terminal. (Keep the AM loop antenna connected).

Cooling Fan

The cooling fan dissipates the heat generated inside the unit so that the unit can be operated normally. The cooling fan is activated automatically to supply cool air to the unit.

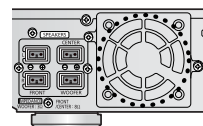

Please observe the following cautions for your safety.

- Make sure the unit is well-ventilated. If the unit has poor ventilation, the temperature inside the unit could rise and may damage it.
- Do not obstruct the cooling fan or ventilation holes. (If the cooling fan or ventilation holes are covered with a newspaper or cloth, heat may build up inside the unit and fire may result.)



Before Using Your DVD Player

Your DVD player is capable of playing DVD, VCD, CD, MP3 and JPEG discs. Depending on the disc you are using, these instructions may vary slightly. Read the instructions carefully before using.

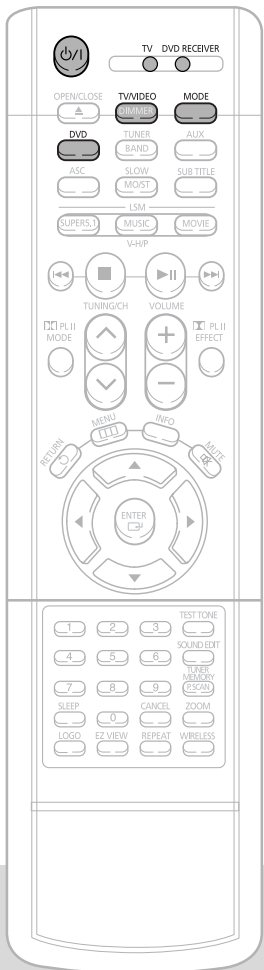

1 Plug the power cord into the AC power supply.

4 Press **TV/VIDEO** button to select VIDEO mode.



2 Press the **MODE** button so that the TV indicator on the remote control flashes.

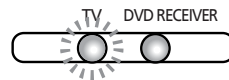

5 Press the **MODE** button so that the DVD RECEIVER indicator on the remote control flashes.

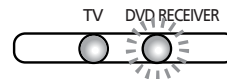

3 Press the **POWER** button to turn on the TV.



6 Press **DVD** button to select DVD/CD mode.

CONNECTIONS

To Operate the TV and DVD Player with a Single Remote Control

Press **MODE** button.

- Each time the button is pressed, the TV indicator (red) and the DVD Receiver indicator (green) will flash alternately.
- You can operate the TV while the TV indicator is flashing and the DVD player while the DVD indicator is flashing.
- Buttons Enabled for TV Operation: POWER, CHANNEL, VOLUME, TV/VIDEO, and Numeric (0-9) buttons.
- By default, the remote control is set to work with Samsung TVs. See page 65 for more information on the operation of the remote control.



Disc Playback



MP3-CD Playback

Data CDs (CD-R, CD-RW) encoded in MP3 format can be played.

1 Press **OPEN/CLOSE** button to open the disc tray.

2 Load a disc.
• Place a disc gently into the tray with the disc's label facing up.

3 Press **OPEN/CLOSE** button to close the disc tray.

DVD VCD CD

• Playback starts automatically.

Note

• Depending on the content of the disc, the initial screen may appear different.

To stop playback, press **STOP** during playback.

- If pressed once, "PRESS PLAY" is displayed and the stop position will be stored in memory. If **PLAY/PAUSE** (▶||) button or **ENTER** button is pressed, playback resumes from the stop position. (This function works only with DVDs.)
- If pressed twice, "STOP" is displayed, and if **PLAY/PAUSE** (▶||) button is pressed, playback starts from the beginning.

To temporarily pause playback, press **PLAY/PAUSE** during playback.

- To resume playback, press **PLAY/PAUSE** (▶||) button again.

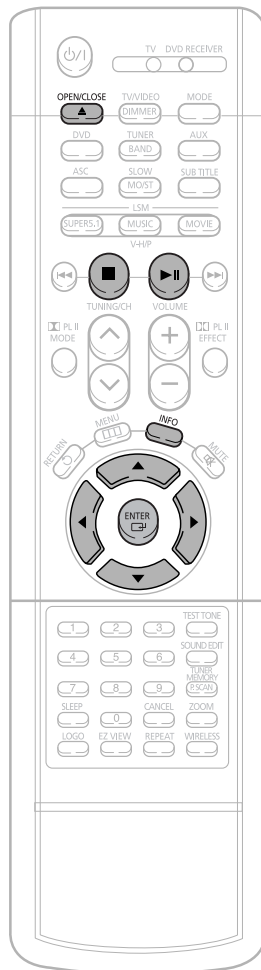

1 Press the **OPEN/CLOSE** button to open the disc tray, and then load the MP3 disc.

- The MP3 menu screen will appear and playback will start.
- Depending on the MP3 disc, the appearance of the menu may be different.



2 In Stop mode, use ◀ ▶ ▲ ▼ to select the album, and then press the **ENTER** button.

3 To change the album, use ◀ ▶ ▲ ▼ to select another album in Stop mode, and then press the **ENTER** button.

- To select another album and track, repeat Steps 2 and 3 above.

4 Press the **STOP** button to stop playback.

Note

- Depending on the recording mode, some MP3-CDs may not play.
- Table of contents of a MP3-CD varies depending on the MP3 track format recorded on the disc.



JPEG Disc Playback

Images captured with a digital camera or camcorder, or JPG files on a PC can be stored on a CD and then played back with this unit.



Displaying Disc Information

You can view disc playback information on the TV screen.

Press the **OPEN/CLOSE** button to open the disc tray, and then load the JPEG disc.

- Playback will start automatically and each image will show for 5 seconds before moving to the next image.

To rotate the image

During playback, press ▲▼◀▶.

- | | |
|-----------------------|-------------------------------|
| ▲ Rotate vertically | ◀ Rotate 90° counterclockwise |
| ▼ Rotate horizontally | ▶ Rotate 90° clockwise |

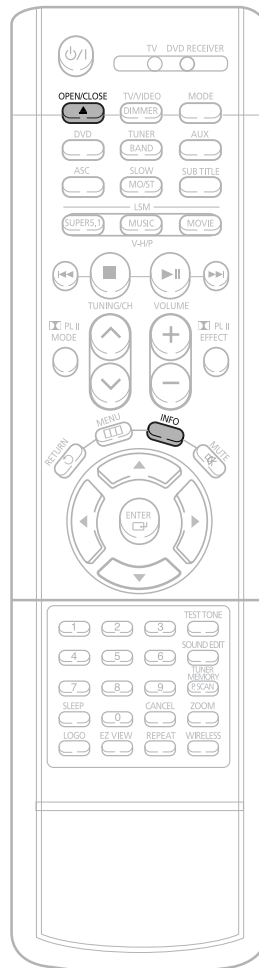
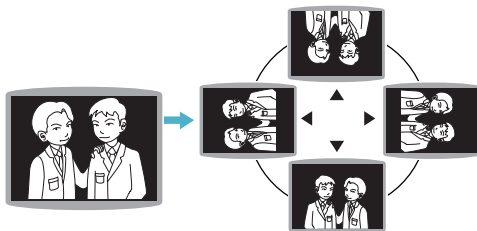

Press **INFO** button.

- Each time the button is pressed, the display changes as follows:

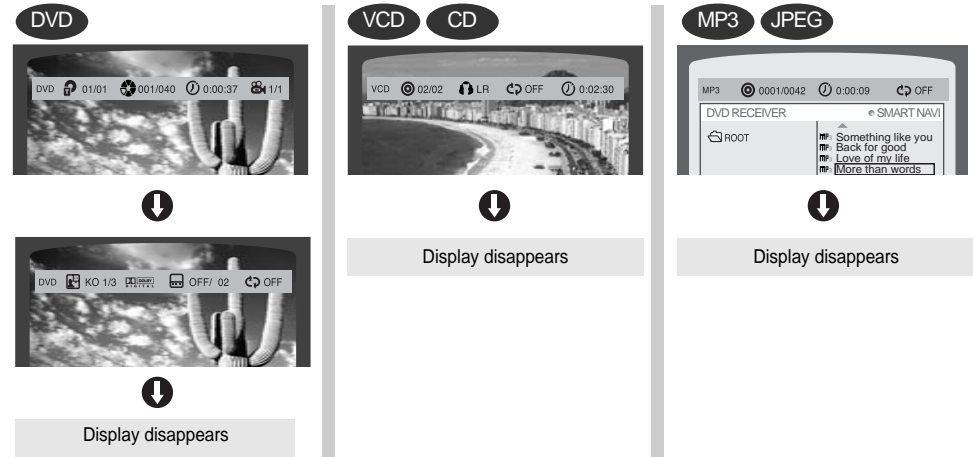

Note

- Depending on the disc, the disc information display may appear different.
- Depending on the disc, you can also select DTS, DOLBY DIGITAL, or PRO LOGIC.

- **What is a Title?**
A movie contained in a DVD disc.
- **What is a Chapter?**
Each title on a DVD disc is divided into several smaller sections called "chapters".
appears on the TV screen!
If this symbol appears on the TV screen while buttons are being operated, that operation is not possible with the disc currently being played.
- **What is a Track (File)?**
A section of video or a music file recorded on a VCD, CD, or MP3-CD.

Screen Display

DVD display	MP3 CD display	TRACK (FILE) display	AUDIO LANGUAGE display	DOLBY DIGITAL DOLBY DIGITAL display
VCD display	TITLE display	ELAPSED TIME display	SUBTITLE display	ANGLE display
CD display	CHAPTER display	REPEAT PLAYBACK display	LR STEREO (L/R) display	

OPERATION



Fast/Slow Playback

Fast Playback DVD VCD CD MP3

Press and hold **⏮** **⏭**.

- Each time the button is held down during playback, the playback speed changes as follows:

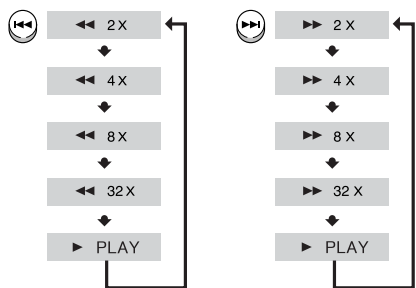

Slow Playback

Press **SLOW** button.

- Each time the button is pressed during playback, the playback speed changes as follows:

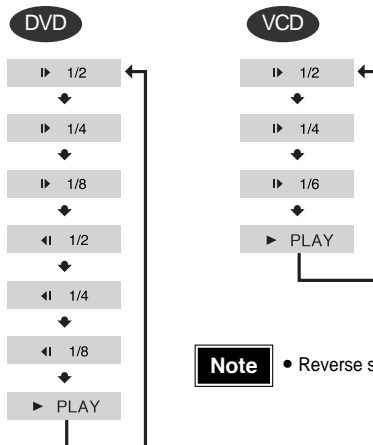

Note • Reverse slow playback does not work with VCDs.

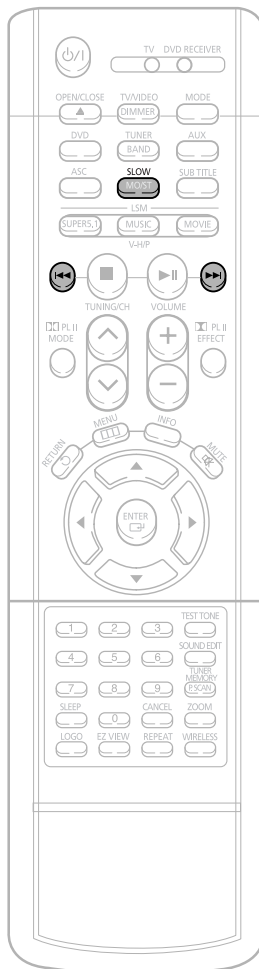

Skipping Scenes/Songs

DVD VCD MP3

Briefly press **⏮** **⏭**.

- Each time the button is pressed briefly during playback, the previous or next chapter, track, or directory (file) will be played.
- You cannot skip chapters consecutively.

DVD

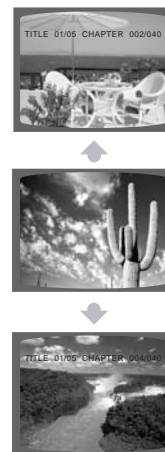

VCD

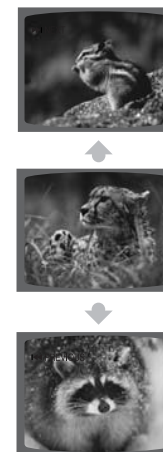

MP3

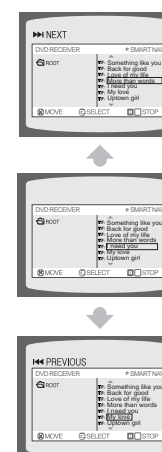

- When watching a VCD with a track longer than 15 minutes, each time **⏮** **⏭** is pressed, playback will skip back or forward 5 minutes.

Note

- During fast playback of a CD or MP3-CD, sound is heard only at 2x speed, and not at 4x, 8x, and 32x speeds.
- No sound is heard during slow playback and step motion playback.

OPERATION

Repeat Playback

Repeat playback allows you to repeatedly play a chapter, title, track (song), or directory (MP3 file).

DVD VCD CD MP3 JPEG

Press **REPEAT** button.

- Each time the button is pressed during playback, the repeat playback mode changes as follows:

DVD

REPEAT : CHAPTER

REPEAT : TITLE

REPEAT : OFF

VCD CD

REPEAT : TRACK

REPEAT : DISC

REPEAT : OFF

MP3 JPEG

REPEAT : RANDOM

REPEAT : TRACK

REPEAT : DIR

REPEAT : DISC

REPEAT : OFF

Repeat Playback Options

CHAPTER

Repeatedly plays the selected chapter.

TITLE

Repeatedly plays the selected title.

RANDOM

Plays tracks in random order.
(A track that has already been played may be played again.)

TRACK

Repeatedly plays the selected track.

DIR

Repeatedly plays all tracks in the selected folder.

DISC

Repeatedly plays the entire disc.

OFF

Cancels Repeat Playback.

To Select a Repeat Playback Mode in the Disc Information Screen

- 1 Press **INFO** button twice.
- 2 Press Cursor **▶** button to move to REPEAT PLAYBACK (↻) display.
- 3 Press Cursor **▼** button to select the desired Repeat Playback mode.
- 4 Press **ENTER** button.

* For MP3 and JPEG discs, you cannot select Repeat Play from the information display screen.

DVD

DVD EN 1/3 OFF/02 OFF
 ↻ A-
 ↻ CHAP
 ↻ TITL

VCD CD

VCD 02/02 L/R OFF/02
 ↻ A-
 ↻ TRACK
 ↻ DISC

Note

- Repeat playback operation is not possible with version 2.0 VCD discs if PBC is turned on. To use Repeat Playback on a VCD with PBC, you should set the PBC to OFF in the disc menu. (See page 35.)

A-B Repeat Playback

DVD VCD CD

- 1 Press **INFO** button twice.

- For a VCD or CD, press **INFO** button once.

DVD EN 1/3 OFF/02 OFF

- 2 Press Cursor **▶** button to move to REPEAT PLAYBACK (↻) display.

DVD EN 1/3 OFF/02 OFF

- 3 Press Cursor **▲**, **▼** buttons to select 'A-' and then press **ENTER** button at the beginning of the segment.

- When **ENTER** button is pressed, the selected position will be stored in memory.

DVD EN 1/3 OFF/02 OFF

DVD EN 1/3 OFF/02 OFF
 ↓
 REPEAT : A-B

- 4 Press **ENTER** button at the end of the segment.

- The specified segment will be played repeatedly.

DVD EN 1/3 OFF/02 OFF

REPEAT : A-B

- To return to normal playback, press Cursor **▲**, **▼** buttons to select **↻ OFF**.

Note

- The A-B Repeat function will not work on an MP3 or JPEG disc.

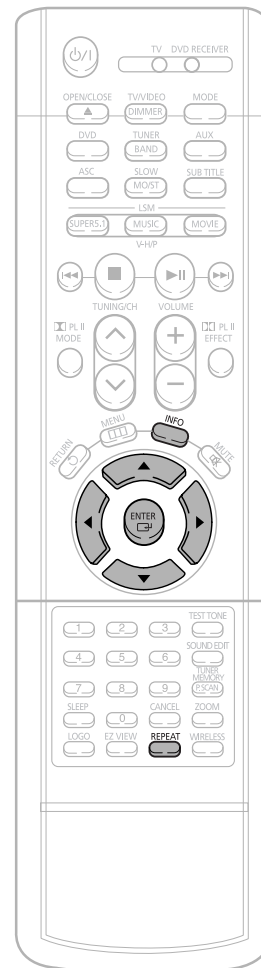

OPERATION



Angle Function

This function allows you to view the same scene in different angles.

DVD

1 Press **INFO** button.

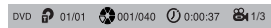

2 Press Cursor **▶** button to move to **ANGLE (&)** display.



3 Press Cursor **▲**, **▼** or numeric buttons to select the desired angle.

• Each time the button is pressed, the angle changes as follows:

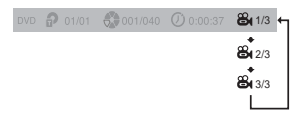

Note • The Angle function works only with discs on which multiple angles have been recorded.

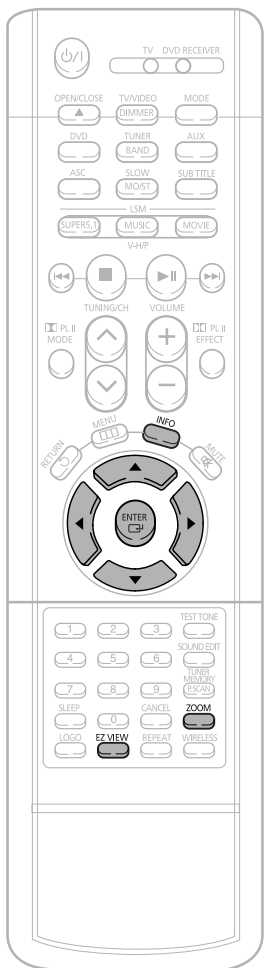

Zoom Function

This function allows you to enlarge a particular area of the displayed image.

Zoom (Screen Enlarge) Function

DVD VCD

1 Press **ZOOM** button.

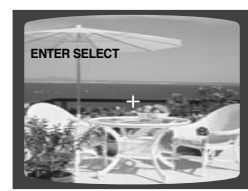

2 Press Cursor **▲**, **▼**, **◀**, **▶** buttons to move to the area you want to enlarge.



3 Press **ENTER** button.

• Each time the button is pressed, the zoom level changes as follows:

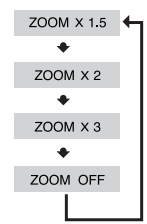

Aspect Ratio

DVD

Press **EZ VIEW** button.

- Each time the button is pressed, the zoom function will switch between On and Off.
- When a movie is played in Widescreen format, black bars at the top and bottom of the TV screen can be removed by pressing the **EZ VIEW** button.

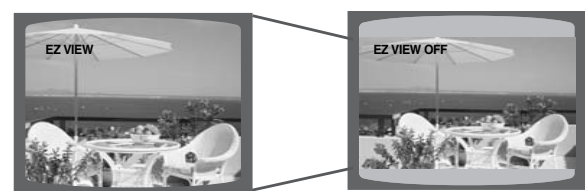

Note

- This function will not work if the DVD is recorded with multi-camera angle format.
- Black bars may not disappear because some DVD discs have a built-in horizontal to vertical ratio.

OPERATION

Selecting Audio/Subtitle Language

Audio Language Selection Function DVD

1 Press **INFO** button twice.

DVD EN 1/3 OFF/ 02

2 Press Cursor **▲**, **▼** buttons or numeric buttons to select the desired audio language.

- Depending on the number of languages on a DVD disc, a different audio language (ENGLISH, SPANISH, FRENCH, etc.) is selected each time the button is pressed.

DVD EN 1/3
SP 2/3
FR 3/3

Subtitle Language Selection Function DVD

1 Press **INFO** button twice.

DVD EN 1/3 OFF/ 02

2 Press Cursor **▶** button to move to **SUBTITLE** display.

DVD EN 1/3 OFF/ 02

3 Press Cursor **▼** button or numeric buttons to select the desired subtitle.

DVD EN 1/3 EN 01/ 03 OFF

SP 02/ 03
FR 03/ 03
OFF / 03

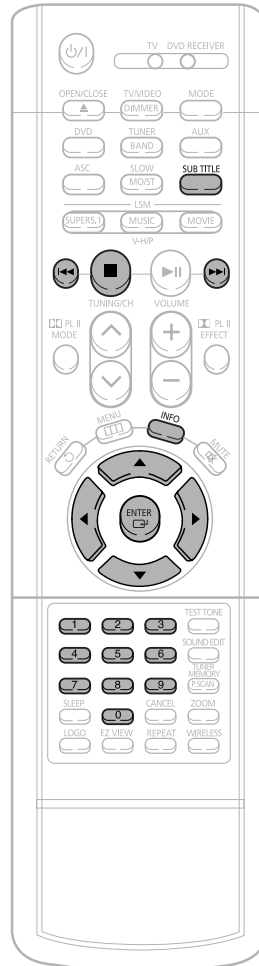

Note

- You can use the **SUBTITLE** button on the remote control to select a subtitle language.
- Depending on the disc, the Subtitle and Audio Language functions may not work.

Moving Directly to a Scene/Song

DVD VCD CD

1 Press **INFO** button.

DVD 01/05 001/040 0:00:37 1/1

Moving to a Title/Track

2 Press Cursor **▲**, **▼** buttons or numeric buttons to select the desired title/track and then press **ENTER** button.

DVD 03/05 001/002 0:00:01 1/1

Moving to a Chapter

3 Press Cursor **◀**, **▶** buttons to move to Chapter () display.

DVD 01/05 001/040 0:00:01 1/1

Moving to a Chapter

4 Press Cursor **▲**, **▼** buttons or numeric buttons to select the desired chapter and then press **ENTER** button.

DVD 01/05 025/040 0:00:01 1/1

Moving to a Specific Time

5 Press Cursor **◀**, **▶** buttons to move to time display.

DVD 01/05 025/040 1:17:30 1/1

Moving to a Specific Time

6 Press the numeric buttons to select the desired time and then press **ENTER** button.

DVD 01/05 028/040 1:30:00 1/1

MP3 JPEG

Press the numeric buttons.

- The selected file will be played.
- An MP3 or JPEG disc cannot be moved from the disc information screen.
- When playing an MP3 or JPEG disc, you cannot use **▲**, **▼** to move a folder. To move a folder, press **■** (Stop) and then press **▲**, **▼**.



Note

- You can press **◀▶▶▶** on the remote control to move directly to the desired title, chapter, or track.
- Depending on the disc, you may not be able to move to the selected title or time.



Using Disc Menu

You can use the menus for the audio language, subtitle language, profile, etc. DVD menu contents differ from disc to disc.



Using the Title Menu

For DVDs containing multiple titles, you can view the title of each movie. Depending on the disc, this function may either not work at all or may work differently.

DVD

1 In Stop mode, press **MENU** button.

- When playing a VCD (version 2.), this toggles between PBC ON and OFF.



2 Press Cursor **▲, ▼** buttons to move to 'DISC MENU' and then press **ENTER** button.

- When you select the disc menu that is not supported by the disc, the "This menu is not supported" message appears on the screen.



3 Press Cursor **▲, ▼, ◀, ▶** buttons to select the desired item.

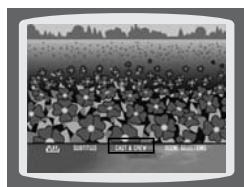

4 Press **ENTER** button.

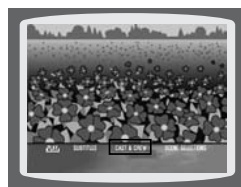

Note

PBC (Playback Control) Function

When playing a VCD (version 2.0), you can select and view various scenes according to the menu screen.

PBC ON: This VCD disc is version 2.0. The disc is played back according to the menu screen. Some functions may be disabled. When some functions are disabled, select "PBC OFF" to enable them.

PBC OFF: This VCD disc is version 1.1. The disc is played back in the same way as with a music CD.

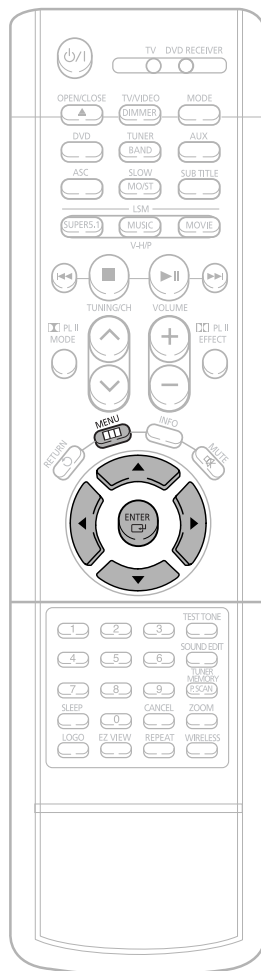

DVD

1 In Stop mode, press **MENU** button.



2 Press Cursor **▲, ▼** button to move to 'Title Menu'.



3 Press **ENTER** button.

- The title menu appears.

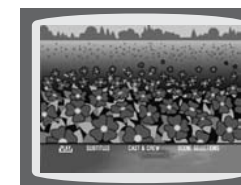

Press **MENU** button to exit the setup screen.

OPERATION

Setting the Language

OSD language is set to English by default.

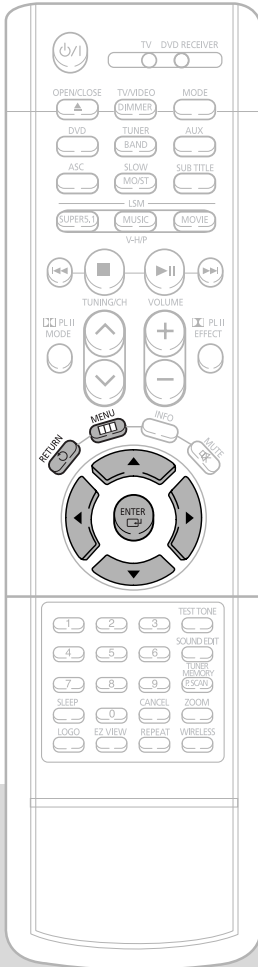

1 In Stop mode, press **MENU** button.



2 Press Cursor **▼** button to move to 'Setup' and then press **ENTER** button.



3 Press **ENTER** button.



4 Press Cursor **▲, ▼** button to select the desired item and then press **ENTER** button.



5 Press Cursor **▲, ▼** button to select the desired language and then press **ENTER** button.

- Once the setup is complete, if the language was set to English, OSD will be displayed in English.



Press **RETURN** button to return to the previous level.

Press **MENU** button to exit the setup screen.



Selecting the OSD Language



Selecting the Audio Language (recorded on the disc)



Selecting the Subtitle Language (recorded on the disc)



Selecting the Disc Menu Language (recorded on the disc)

* If the language you selected is not recorded on the disc, menu language will not change even if you set it to your desired language.

Setting TV Screen type

Depending on your TV type (Wide Screen TV or conventional 4:3 TV), you can select the TV's aspect ratio.

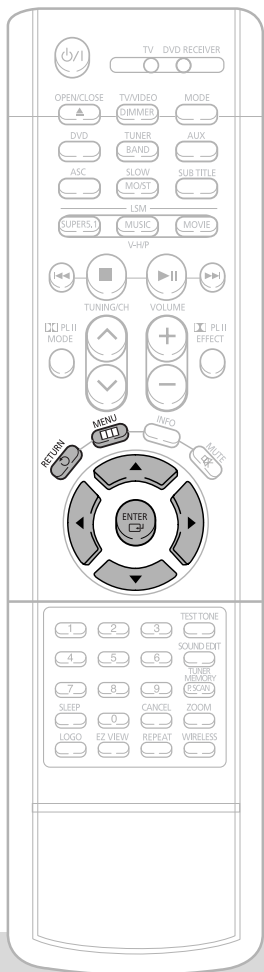

1 In Stop mode, press **MENU** button.



2 Press Cursor \blacktriangledown button to move to 'Setup' and then press **ENTER** button.



3 Press Cursor \blacktriangledown button to move to 'TV DISPLAY' and then press **ENTER** button.



4 Press Cursor \blacktriangle , \blacktriangledown button to select the desired item and then press **ENTER** button.

• Once the setup is complete, you will be taken to the previous screen.



Adjusting the TV Aspect Ratio (Screen Size)

The horizontal to vertical screen size ratio of conventional TVs is 4:3, while that of wide screen and high definition TVs is 16:9. This ratio is called the aspect ratio. When playing DVDs recorded in different screen sizes, you should adjust the aspect ratio to fit your TV or monitor.

★ For a standard TV, select either "4:3LB" or "4:3PS" option according to personal preference. Select "16:9" if you have a wide screen TV.

WIDE

: Select this to view a 16:9 picture in the full-screen mode on your wide screen TV.
• You can enjoy the wide screen aspect.



4:3LB (4:3 Letterbox)

: Select this to play a 16:9 picture in the letter box mode on a conventional TV.
• Black bars will appear at the top and bottom of the screen.



4:3PS (4:3 Pan&Scan)

: Select this to play a 16:9 picture in the pan & scan mode on a conventional TV.
• You can see the central portion of the screen only (with the sides of the 16:9 picture cut off).

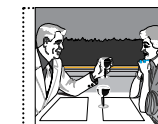

Note

- If a DVD is in the 4:3 ratio, you cannot view it in wide screen.
- Since DVD discs are recorded in various image formats, they will look different depending on the software, the type of TV, and the TV aspect ratio setting.

Press **RETURN** button to return to the previous level.

Press **MENU** button to exit the setup screen.



Setting Parental Controls (Rating Level)

Use this to restrict playback of adult or violent DVDs you do not want children to view.

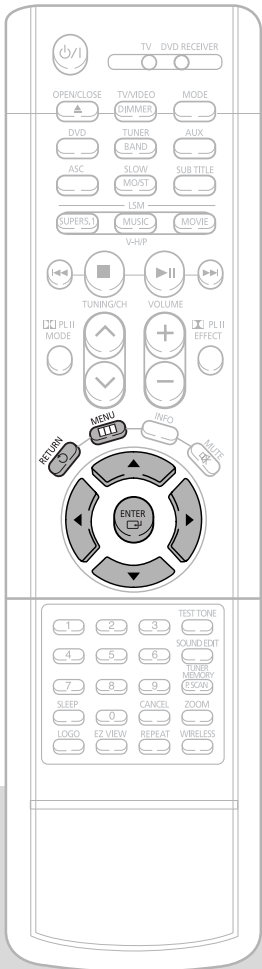

1 In Stop mode, press **MENU** button.



2 Press Cursor **▼** button to move to 'Setup' and then press **ENTER** button.



3 Press Cursor **▼** button to move to 'PARENTAL' and then press **ENTER** button.



4 Press Cursor **▲, ▼** button to select the desired rating level and then press **ENTER** button.



5 Enter the password and then press **ENTER** button.



- If you have selected Level 6, you cannot view DVDs with Level 7 or higher.
- The higher the level, the closer the content is to violent or adult material.

- The password is set to "7890" by default.
- Once the setup is complete, you will be taken to the previous screen.

Note • This function works only if a DVD disc contains the rating level information.

Press **RETURN** button to return to the previous level.

Press **MENU** button to exit the setup screen.

SETUP

Setting the Password

You can set the password for the Parental (rating level) setting.

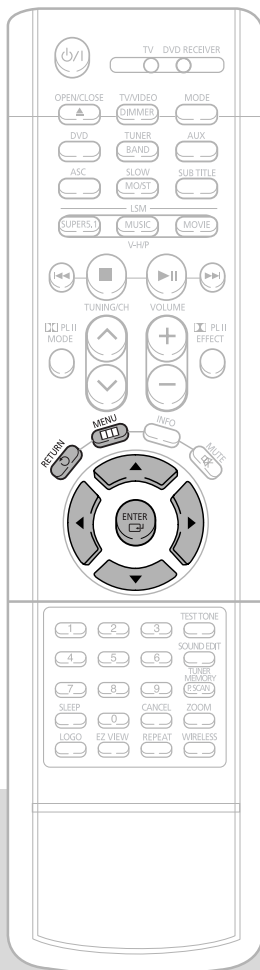

1 Press **MENU** button.



2 Press Cursor **▼** button to move to 'Setup' and then press **ENTER** button.



3 Press Cursor **▼** button to move to 'PASSWORD' and then press **ENTER** button.



4 Press **ENTER** button.



5 Enter the password and then press **ENTER** button.

- Enter the old password, a new password, and confirm new password.
- The setting is complete.



Note • The password is set to "7890" by default.

Press **RETURN** button to return to the previous level.

Press **MENU** button to exit the setup screen.



Setting the Wallpaper JPEG DVD VCD

While watching a DVD, VCD, or JPEG CD, you can set the image you like as a wallpaper.

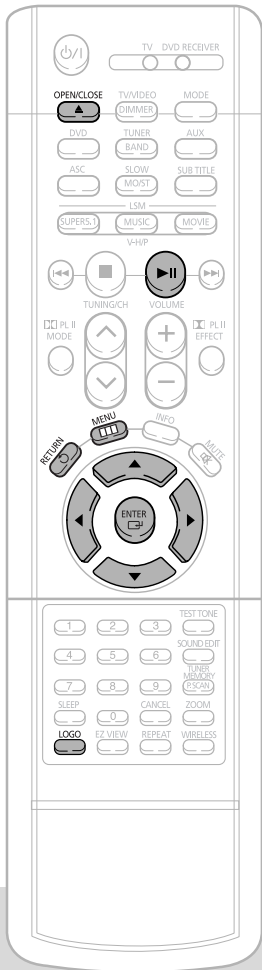

1 During playback, press **PLAY/PAUSE** button when an image you like appears.



2 Press **LOGO** button.

• "LOGO COPYING" will be displayed on the TV screen followed by "LOGO COPIED".



3 In Stop mode, press **MENU** button.



4 Press **Cursor** button to move to 'Setup' and then press **ENTER** button.



5 Press **Cursor** button to move to 'LOGO' and then press **ENTER** button.



6 Press **Cursor** button to move to 'USER' and then press **ENTER** button.



7 Press **MENU** button to exit the setup screen.

8 Press **OPEN/CLOSE** button to open and then close the disc tray.

Press **RETURN** button to return to the previous level.

Press **MENU** button to exit the setup screen.

SETUP



Select this to set the Samsung Logo image as your wallpaper.



Select this to set the desired image as your wallpaper.

To Change the Wallpaper JPEG DVD VCD

1 During playback, press **PLAY/PAUSE** button when you see an image you like.



2 Press **LOGO** button.

• "LOGO COPYING" will be displayed on the TV screen followed by "LOGO COPIED".



3 Press **OPEN/CLOSE** button to open and then close the disc tray.
• The wallpaper is changed.

Setting the Speaker Mode

Signal outputs and frequency responses from the speakers will automatically be adjusted according to your speaker configuration and whether certain speakers are used or not.

1 In Stop mode, press **MENU** button.



2 Press Cursor **▼** button to move to 'Audio' and then press **ENTER** button.



3 In the Speaker Setup, press the **ENTER** button again.



4 Press Cursor **▲, ▼, ◀, ▶** buttons to move to the desired speaker and then press **ENTER** button.

- For C, LS, and RS, each time the button is pressed, the mode switches alternately as follows: SMALL → NONE.
- For L and R, the mode is set to SMALL.



- SMALL**: Select this when using the speakers.
- NONE**: Select this when no speakers are installed.

Note

- Depending on PRO LOGIC and STEREO, the speaker mode may vary.

Setting the Test Tone

Use the Test Tone feature to check the speaker connections and to adjust the speaker levels.

1 In Stop mode, press **MENU** button.



2 Press Cursor **▼** button to move to 'Audio' and then press **ENTER** button.



3 Press Cursor **▼** button to move to 'TEST TONE' and then press **ENTER** button.

- The test tone will be sent to L → C → R → RS → LS → SW in that order. If the ENTER button is pressed again at this time, the test tone will stop.



Press **RETURN** button to return to the previous level.

Press **MENU** button to exit the setup screen.

SETUP

Alternate method: press the **TEST TONE** button on the remote.

- L: Front Speaker (L) C: Center Speaker SW: Subwoofer
- R: Front Speaker (R) LS: Rear Speaker (L) RS: Rear Speaker (R)

Press **TEST TONE** button.

- Test tone will be produced as follows: When playing a DVD or CD, this will work only in Stop mode.
- Use this function to check that each speaker is correctly connected and that there is no problem.

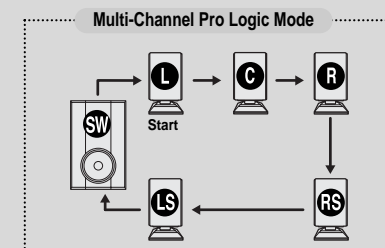

To end the test tone, press **TEST TONE** button again.

Setting the Delay Time

If the speakers cannot be placed at equal distances from the listening position, you can adjust the delay time of the audio signals from the center and rear speakers.

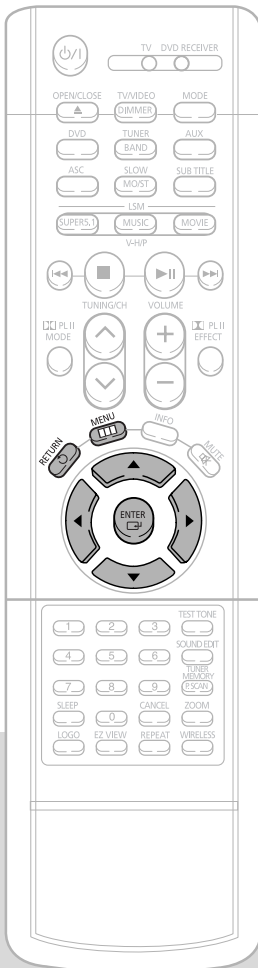

1 Press **MENU** button.



2 Press **Cursor** \blacktriangledown button to move to 'Audio' and then press **ENTER** button.



3 Press **Cursor** \blacktriangledown button to move to 'DELAY TIME' and then press **ENTER** button.



4 Press **Cursor** \blacktriangle , \blacktriangledown , \blacktriangleleft , \blacktriangleright buttons to move to the desired speaker and then press **ENTER** button.



5 Press **Cursor** \blacktriangleleft , \blacktriangleright to set the Delay time.

- You can set the delay time for C between 00 and 05mSEC and for LS and RS between 00 and 15mSEC.



Press **RETURN** button to return to the previous level.

Press **MENU** button to exit the setup screen.

Setting up the Speaker Delay Time

When 5.1CH Surround Sound is played, you can enjoy the best sound if the distance between you and each speaker is the same. Since the sounds arrive at the listening position at different times depending on the placement of speakers, you can adjust this difference by adding a delay effect to the sound of the Center Speaker and Surround Speakers.

Note

- With \square PL (Dolby Pro Logic II), the delay time may be different for each mode.
- With AC-3 and DTS, the delay time can be set between 00 and 15mSEC.

Setting CENTER SPEAKER

If the distance of Dc is equal to or longer than the distance of Df in the figure, set the mode as 0ms. Otherwise, change the setting according to the table.

Distance between Df and Dc	Delay Time
0 inch	0 ms
13.6 inches	1 ms
27.2 inches	2 ms
40.8 inches	3 ms
4.5 feet	4 ms
5.6 feet	5 ms

Setting REAR (SURROUND) SPEAKERS

If the distance of Df is equal to the distance of Ds in the figure, set the mode as 0ms. Otherwise, change the setting according to the table.

Distance between Df and Ds	Delay Time
0 inch	0 ms
40.8 inches	3 ms
6.7 feet	6 ms
10.0 feet	9 ms
13.4 feet	12 ms
16.7 feet	15 ms

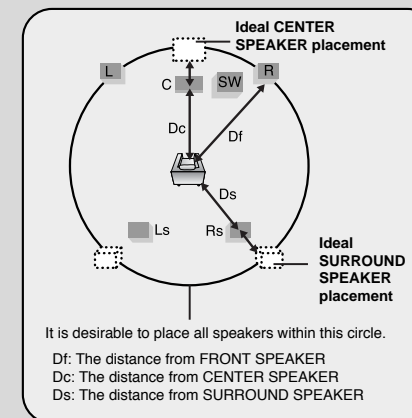

Setting the Audio Quality

You can adjust the balance and level for each speaker.

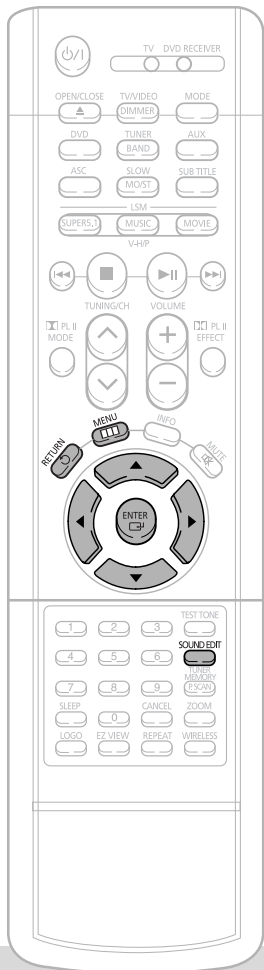

Method 1 When adjusting the audio quality using the setup screen

1 In Stop mode, press **MENU** button.



2 Press Cursor **▼** button to move to 'Audio' and then press **ENTER** button.



3 Press Cursor **▼** button to move to 'SOUND EDIT' and then press **ENTER** button.



4 Press Cursor **▲, ▼** buttons to select and adjust the desired item. Press the **◀, ▶** buttons to adjust the settings.



Method 2 When manually adjusting with the SOUND EDIT button

Adjusting Front Speaker Balance

1 Press **SOUND EDIT** button and then press Cursor **◀, ▶**.



Adjusting Rear Speaker Balance

2 Press **SOUND EDIT** button and then press Cursor **◀, ▶**.



Adjusting Center Speaker Level

3 Press **SOUND EDIT** button and then press Cursor **◀, ▶**.



Adjusting Rear Speaker Level

4 Press **SOUND EDIT** button and then press Cursor **◀, ▶**.



Adjusting Subwoofer Speaker Level

5 Press **SOUND EDIT** button and then press Cursor **◀, ▶**.



Press **RETURN** button to return to the previous level.

Press **MENU** button to exit the setup screen.

Note

- The adjustments will appear on the main unit, not on your TV screen.

Adjusting Front/Rear Speaker Balance

- You can select between 00 and -06 and OFF.
- The volume decreases as you move closer to -6.

Adjusting Center/Rear/Subwoofer Speaker Level

- The volume level can be adjusted in steps from +6dB to -6dB.
- The sound gets louder as you move closer to +6dB and quieter as you get closer to -6dB.



Setting the DRC (Dynamic Range Compression)

You can use this function to enjoy Dolby Digital sound when watching movies at low volume at night.

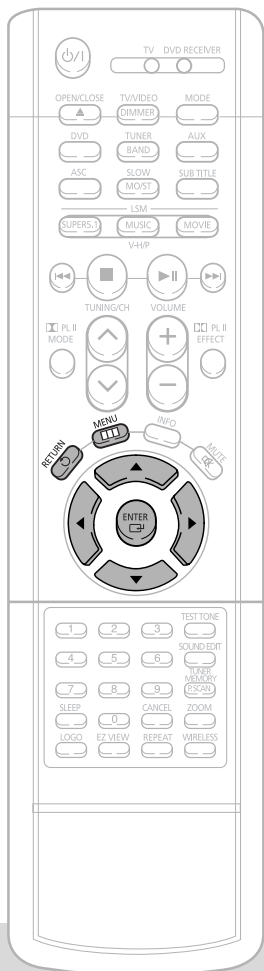

1 In Stop mode, press **MENU** button.

2 Press Cursor **▼** button to move to 'Audio' and then press **ENTER** button.

3 Press Cursor **▼** button to move to 'DRC' and then press **ENTER** button.

4 Press Cursor **▲, ▼** to adjust the 'DRC'.

- Pressing the Cursor **▲** button increases the compression, and pressing the Cursor **▼** reduces it.

- Press **RETURN** button to return to the previous level.
- Press **MENU** button to exit the setup screen.



Auto Sound Calibration Setup

* This function is available only for DVD/CD playback.

Auto Sound Calibration

By setting the auto sound calibration function just once when you relocate or install the unit, you can have the unit automatically recognize the distance between speakers, levels between channels, and frequency characteristics to create 5.1-channel sound field optimized for the listener's environment.

* The following images are for illustrative purposes only and may differ from the actual product.

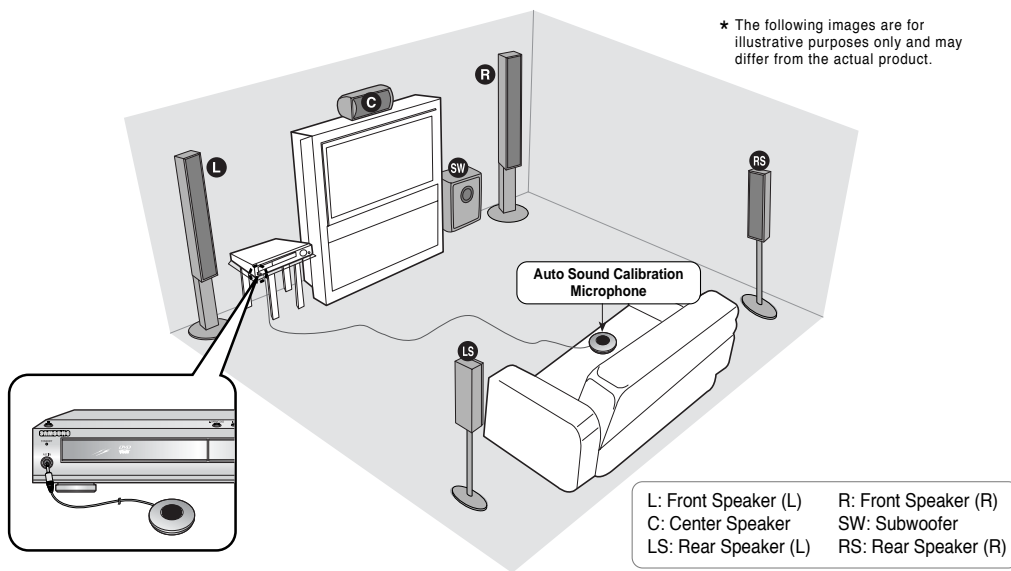

L: Front Speaker (L) R: Front Speaker (R)
C: Center Speaker SW: Subwoofer
LS: Rear Speaker (L) RS: Rear Speaker (R)

Note

- If you purchased the unit for the first time or initialized it, pressing the Auto Sound Calibration button without connecting the auto sound calibration microphone will display the message "PLEASE SET ASC FUNCTION FIRST" in the display.
- Because the volume level of the tone is fixed during the auto sound calibration setup, you cannot adjust the volume using the volume control buttons.
- If the auto sound microphone is disconnected during the auto sound calibration setup, the setup will be cancelled.

1 Plug the auto sound calibration microphone into the auto sound calibration input jack.

2 Place the auto sound calibration microphone at the listener's position.

3 Adjust the volume control on the main unit as follows:

- If the distance between the listener and the speaker is over 16.5 feet: Set the main unit's volume to over 25.
- If the distance between the listener and the speaker is 10 to 16.5 feet: Set the main unit's volume to 25.
- If the distance between the listener and the speaker is below 10 feet: Set the main unit's volume to 15.

4 Press ASC button.

- The tone will be output twice, in the given order (L → C → R → RS → LS → SW), and 5.1-channel sound field is optimized automatically.
- The auto sound calibration setup takes about 2 minutes to complete.



A tone is output.



A result for each speaker is displayed.

A bell sounds and the setup finishes.

5 When the message "REMOVE MIC" appears in the display, unplug the auto sound calibration microphone.

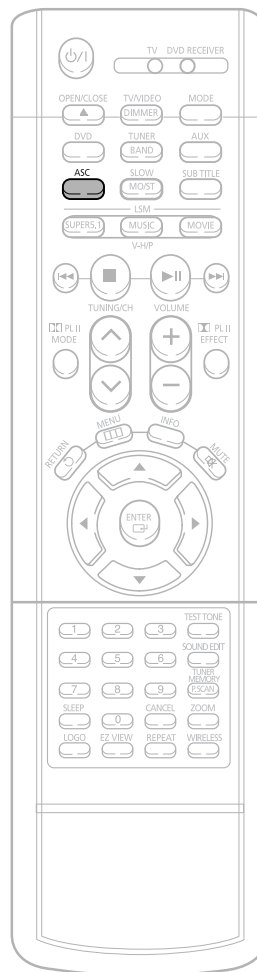

To Turn On or Off Sound Logo

When you turn on the power, the unit produces a sound logo after the disc reading to notify that the unit is optimized for playback.

- 1 Press and hold **ASC** button.
 - "S.LOGO ON" or "S.LOGO OFF" appears in the display.
- 2 Briefly press **ASC** button.
 - Each time the button is pressed, the selection alternates between S.LOGO ON and S.LOGO OFF.
 - If you select "S.LOGO ON", a sound logo will be output when the disc reading is finished after power-on. If you select "S.LOGO OFF", no sound logo will be output.

To Verify the Auto Sound Calibration

- 1 Press and hold **ASC** button twice.
 - "ASC CHECK" appears in the display.
- 2 Briefly press **ASC** button.
 - Distance and level values specified for each channel will appear in the display.

To cancel the auto sound calibration setup, press ASC button.

- The tone output stops, "CANCEL ASC" appears in the display followed by "REMOVE MIC", and the setup is cancelled.

To listen in the auto sound calibration mode, briefly press ASC button.

(If you set the auto sound calibration in the order from 1 to 4 above for the first time)

- The selection alternates between ASC ON and ASC OFF in the display.
- If you select "ASC ON", you will hear sound in the auto sound calibration mode.
- If you select "ASC OFF", you will hear sound in the mode set in the audio setting of the setup screen



Live Surround Mode

SUPER 5.1

You can reproduce a 2-channel sound source, such as CD, and radio broadcast, in 5.1-channel surround sound.

Press **SUPER5.1** button.

- Each time the button is pressed, the selection alternates between SUPER 5.1 and SUPER OFF.
- Select "SUPER 5.1" to play 2-channel sound in 5.1 channels.



MUSIC

If you press the **MUSIC** button when listening to a 2-channel sound source, it will be reproduced in 5.1-channel surround sound so that you can enjoy a dynamic sound with a sense of presence.

Press **MUSIC** button.

- Each time the button is pressed, the selection changes as follows:

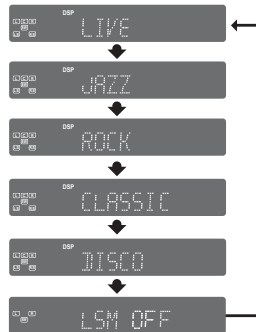

MOVIE

You can select from 3 different modes of sound field for movies.

Press **MOVIE** button.

- Each time the button is pressed, the selection changes as follows:

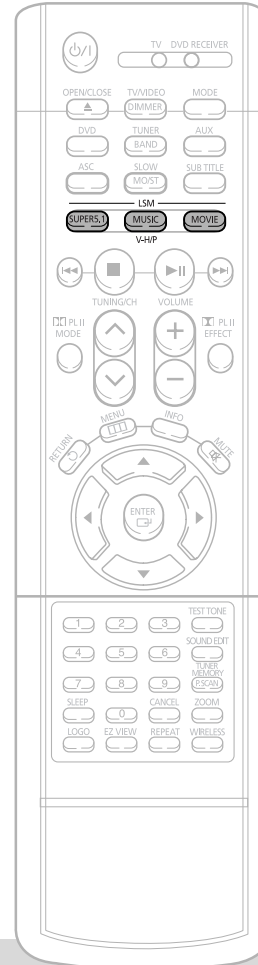

Magic Headphone Function

Use headphones (not supplied) for private listening pleasure. You can enjoy a dynamic sound effects similar to that of 5.1 channel surround sound using conventional stereo headphones.

1 Plug the headphones into the headphone jack.

- You can purchase headphones from most Electronics stores.

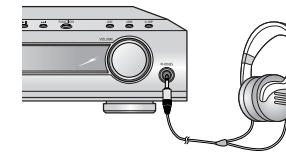

2 Press **V-H/P** button.

- Each time the button is pressed, the selection alternates between **VIRTUAL ON** and **VIRTUAL OFF**.



- Note**
- Do not listen at extremely high volume levels when using headphones. Extended, high-volume listening can lead to permanent hearing loss.

- Note**
- When you insert a DVD recorded in 2-channel or multi-channel format and press the SUPER 5.1 button, the message "THIS FUNCTION APPLIES ONLY 2CH SOURCE" appears in the display and it will not work.

- **VIRTUAL ON:** Select to enjoy a 5.1-channel surround sound that gives the feeling of being in a baseball park or concert hall.
- **VIRTUAL OFF:** Select to listen to a standard 2-channel stereo sound.

Dolby Pro Logic II Mode

You can select the desired Dolby Pro Logic II audio mode.

Press **PL II MODE** button.

- Each time the button is pressed, the mode changes as follows.

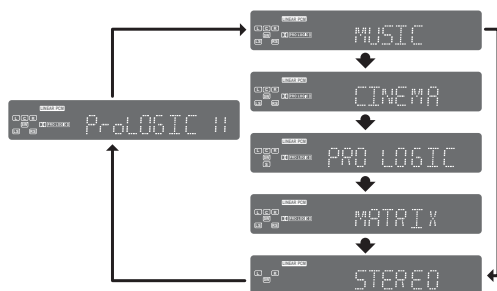

Note

- When selecting Pro Logic II mode, connect your external device to the AUDIO INPUT jacks (L and R) on the player. If you connect to only one of the inputs (L or R), you cannot listen to 5.1 channel surround sound.

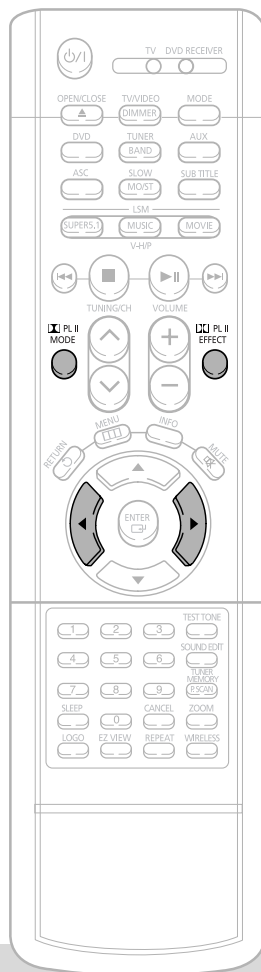

Dolby Pro Logic II Effect

This function works only in Dolby Pro Logic MUSIC mode.

1 Press **PL II MODE** button to select 'MUSIC' mode.



2 Press **PL II EFFECT** button and then press Cursor **◀, ▶** buttons to select the mode.

- You can select either 0 or 1.



3 Press **PL II EFFECT** button and then press Cursor **◀, ▶** buttons to select the mode.

- You can select between 0 and 7.



4 Press **PL II EFFECT** button and then press Cursor **◀, ▶** buttons to select the mode.

- You can select between 0 and 6.



Note

- When playing a DVD disc encoded with two or more channels, multi-channel mode will be selected automatically and **PL II** (Dolby Pro Logic II) button does not work.

PRO LOGIC II

- **MUSIC:** When listening to music, you can experience sound effects as if you are listening to the actual performance.
- **CINEMA:** Adds realism to the movie soundtrack.
- **PRO LOGIC:** You will experience a realistic multi-channel effect, as if using five speakers, while using just the front left and right speakers.
- **MATRIX:** You will hear 5.1 channel surround sound.
- **STEREO:** Select this to listen to sounds from the front left and right speakers and the subwoofer only.

- **PANORAMA:** This mode extends the front stereo image to include the surround speakers for an exciting "wraparound" effect with side wall imaging.
- **CENTER WIDTH:** Sound is output to the center speaker only. The front left and right speakers produce phantom sound.
- **DIMENSION:** Incrementally adjusts the sound field (DSP) from the front or rear.

Listening to Radio

You can listen to the chosen band (FM, AM broadcast stations) by using either the automatic or manual tuning operation.

Presetting Stations

You can store up to:

- ◆ 15 FM stations
- ◆ 15 AM stations

- FM Frequency Modulation
- AM Medium Wave

Remote Control Unit

1 Press TUNER/BAND button.

- The selection toggles back and forth between "FM → AM" each time the **TUNER(BAND)** button is pressed.

2 Tune in to the desired station.

- Automatic Tuning 1** When **◀▶▶▶** is pressed, a preset broadcast station is selected.
- Automatic Tuning 2** Press and hold **TUNING↑** to automatically search for active broadcasting stations.
- Manual Tuning** Briefly press **TUNING↑** to increase or decrease the frequency incrementally.

Main Unit

1 Press the Function button to select the desired band (FM, AM).

2 Select a broadcast station.

- Automatic Tuning 1** Press the **STOP** button to select **PRESET** and then press **◀▶▶▶** button to select the preset station.
- Automatic Tuning 2** Press the **STOP** button to select "MANUAL" and then press and hold **◀▶▶▶** button to automatically search the band.
- Manual Tuning** Press **STOP** to select **MANUAL** and then briefly press **◀▶▶▶** to tune in to a lower or higher frequency.

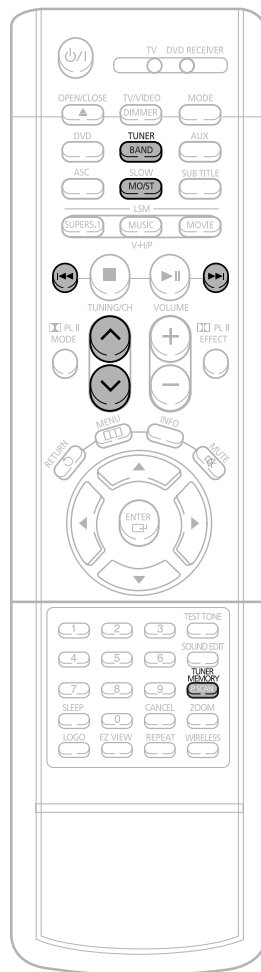

Example: Presetting FM 89.1 in the memory

1 Press the TUNER(BAND) button and select the FM band.

- Each time the button is pressed, the band switches between "FM → AM".



2 Press TUNING↑ to select "89.10".

- Refer to Step 2 on page 61 to automatically or manually tune in to a station.



3 Press the TUNER MEMORY button.

- "PRGM" flashes in the display.



4 Press ◀▶▶▶ to select preset number.

- You can select between 1 and 15.



5 Press the TUNER MEMORY button again.

- Press the **TUNER MEMORY** button before 'PRGM' disappears from the display.
- 'PRGM' disappears from the display and the station is stored in memory.



6 To preset another station, repeat steps 2 to 5.

Press **MO/ST** button to listen in Mono/Stereo.
(This applies only when listening to an FM station.)

- Each time the button is pressed, the sound switches between "STEREO" and "MONO".
- In a poor reception area, select MONO for a clear, interference-free broadcast.

To tune in to a preset station, press **◀▶▶▶** on the remote control to select a channel.



Convenient Functions

Sleep Timer Function

You can set the time that the DVD player will shut itself off.

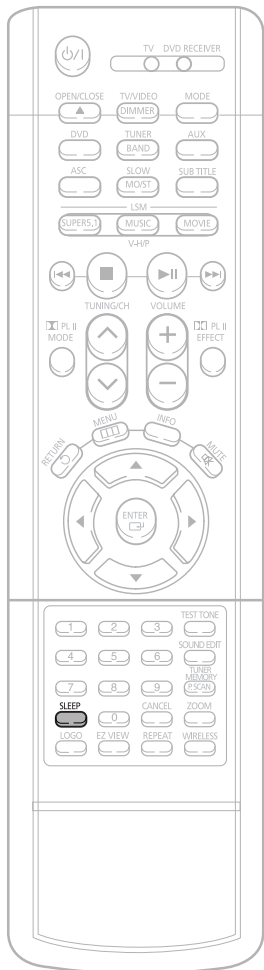

Press **SLEEP** button.

- "SLEEP" will be displayed. Each time the button is pressed the preset time changes as follows: 10 → 20 → 30 → 60 → 90 → 120 → 150 → OFF.



To confirm the sleep timer setting, press **SLEEP** button.

- The remaining time before the DVD player will shut itself off is displayed.
- Pressing the button again changes the sleep time from what you have set earlier.

To cancel the sleep timer, press **SLEEP** button until OFF appears on the display.

Adjusting Display Brightness

You can adjust the brightness of the display on the main unit so it won't interfere with your movie viewing.

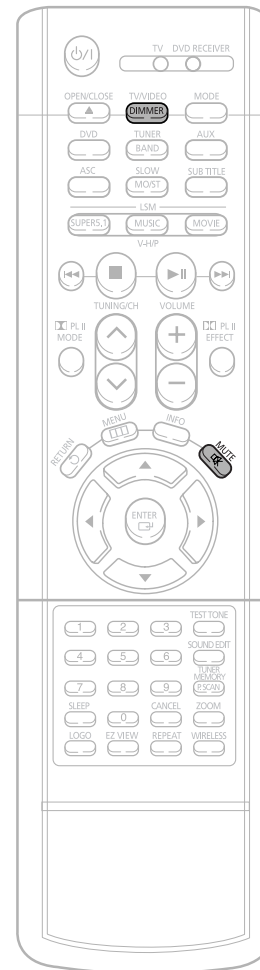

Press **DIMMER** button.

- Each time the button is pressed, the brightness changes as follows: 'SLIGHTLY DARK, DARK BRIGHT'.

Mute Function

This is useful when answering a doorbell or telephone call.

Press **MUTE** button.

- 'MUTE' flash in the display.
- To switch the sound back on (at the same volume as before), press **MUTE** again or the **VOLUME** buttons.

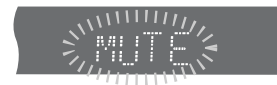



Operating a TV with the Remote Control

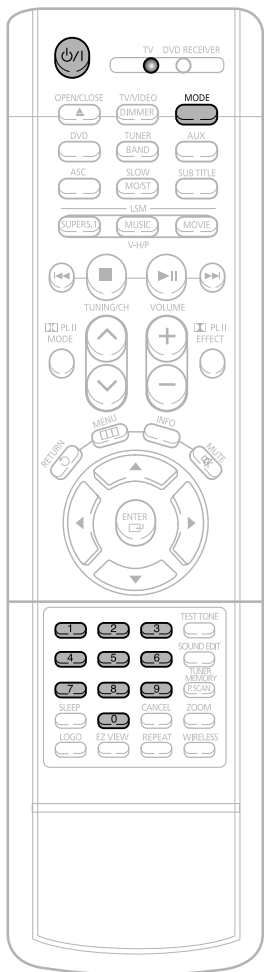

When operating a TV with the remote control

1 Press the **MODE** button to make the TV indicator on the remote control flash.



2 Press **POWER** button to turn on the TV.

3 Point the remote control toward the TV.

4 While holding down **POWER**, enter the code corresponding to your brand of TV.

- If the code matches the TV's code, the TV will be turned off.
- If there is more than one code listed for your TV in the table, enter one at a time to determine which code works.

Example: For a Samsung TV

While holding down **POWER**, use the number buttons to enter 00, 01, 02, 03, 04, and 05.

5 Point the remote control toward the TV and press **POWER**. If the TV turns off or on, the setting is complete.

- You can use the TV **POWER**, **VOLUME**, **CHANNEL**, and **Numeric** buttons (0~9).

Note

- The remote control may not work on some brands of TVs. Also some operations may not be possible depending on your brand of TV.
- If you do not set the remote control with the code for your brand of TV, the remote control will work on a Samsung TV by default.

TV Brand Code List



No.	Brand	Code	No.	Brand	Code
1	SAMSUNG	00(Initial Value), 01, 02, 03, 04, 05, 73	30	BRANDT	41
2	ANAM	06~11, 59	31	FERGUSON	41
3	DAEWOO	12~18, 20, 21	32	PIONEER	41, 48, 74
4	LG	05, 20, 21, 22, 53	33	TELEVA	41
5	HITACHI	23, 40, 41, 49	34	FINLUX	05, 42, 47
6	JVC	24, 55	35	FISHER	31
7	SHARP	27, 33, 34, 35, 54	36	AKAI	31
8	SONY	27, 36	37	YOKO	05
9	TOSHIBA	27, 37, 42, 43, 44, 46	38	PHONOLA	05, 45, 47
10	SANYO	27, 30, 31, 32	39	RADIOLA	05, 45
11	mitsubishi	05, 27, 28	40	SCHNEIDER	05
12	MATSUSHITA	09, 26	41	NEWSAN	58
13	TELEFUNKEN	41, 49, 51, 57	42	CONTINENTAL EDISON	49
14	RCA	29, 61	43	SALORA	48
15	PANASONIC	07, 09, 26, 48, 49, 50	44	SELECO	48
16	SABA	40, 41, 47, 48, 49	45	NOKIA	48
17	PHILIPS	05, 45, 47, 64, 65, 66, 67, 68, 69	46	REX	48
18	GRUNDIG	39, 42, 46, 70, 71, 72	47	MIVAR	46
19	ZENITH	38	48	IMPERIAL	46
20	MIVAL	52	49	CGE	46
21	NOBLEX	56	50	BANG & OLUFSEN	47
22	EMERSON	19	51	BRIONVEGA	47
23	MAGNAVOX	25	52	FORMENTI	47
24	LOEWE	05, 60	53	METZ	47
25	THOMSON	40, 41, 49, 62, 63	54	WEGA	47
26	NORDMENDE	40, 41, 49	55	RADIOMARELLI	47
27	LOEWE OPTA	36, 47, 05	56	SINGER	47
28	BLAUPUNKT	39	57	SINUDYNE	47
29	SIEMENS	39			



Before Calling for Service

Refer to the chart below when this unit does not function properly. If the problem you are experiencing is not listed below or if the instruction below does not help, turn off the unit, disconnect the power cord, and contact the nearest authorized dealer or Samsung Electronics Service Center.

Symptom	Check/Remedy
Disc tray does not open.	<ul style="list-style-type: none"> • Is the power cord plugged securely into the outlet? • Turn off the power and then turn it back on.
Playback does not start.	<ul style="list-style-type: none"> • Is the region code of the disc "1" or "ALL"? • DVD discs purchased from abroad may not be playable. • CD-ROMs and DVD-ROMs cannot be played on this DVD player. • Make sure that the rating level is correct.
Playback does not start immediately when the Play/Pause button is pressed.	<ul style="list-style-type: none"> • Are you using a deformed disc or a disc with scratches on the surface? • Wipe the disc clean.
Sound is not produced.	<ul style="list-style-type: none"> • No sound is heard during fast playback, slow playback, and step motion playback. • Are the speakers connected properly? Is the speaker setup correctly customized? • Is the disc severely damaged?
Sound can be heard only from a few speakers and not all six.	<ul style="list-style-type: none"> • When listening to a CD or radio, sound is output to the front speakers (L/R) only. Select "PRO LOGIC II" by pressing \squarePL II (Dolby Pro Logic II) on the remote control to use all six speakers. • Make sure that the DVD disc is 5.1-CH compatible. • If you set C, SL, and SR to NONE in the speaker mode in the audio setup of the setup screen, no sound is heard from the center speaker and the front left and right speakers. Set C, SL, and SR to SMALL.
Picture does not appear, sound is not produced, or the disc tray opens 2 to 5 seconds later.	<ul style="list-style-type: none"> • Was the DVD player suddenly moved from a cold place to a warm one? When condensation forms inside the player, remove the disc and let the player stand for 1 or 2 hours with the power on. (You can use the player again after condensation disappears.)
Dolby Digital 5.1 CH Surround Sound is not produced.	<ul style="list-style-type: none"> • Is there a "Dolby Digital 5.1 CH" mark on the disc? Dolby Digital 5.1 CH Surround Sound is produced only if the disc is recorded with 5.1 channel sound. • Is the audio language correctly set to DOLBY DIGITAL 5.1-CH in the information display?

Symptom	Check/Remedy
<ul style="list-style-type: none"> • Disc is rotating but no picture is produced. • Picture quality is poor and picture is shaking. 	<ul style="list-style-type: none"> • Is the TV power on? • Are the video cables connected properly? • Is the disc dirty or damaged? • A poorly manufactured disc may not be playable.
The remote control does not work.	<ul style="list-style-type: none"> • Is the remote control being operated within its operation range of angle and distance? • Are the batteries exhausted? • Have you selected the mode(TV/DVD) functions of the remote control (TV or DVD) correctly?
Audio language and subtitles do not work.	<ul style="list-style-type: none"> • Audio language and subtitles will not work for DVDs not containing them. And depending on the disc, they may work differently.
Menu screen does not appear even when the menu function is selected.	<ul style="list-style-type: none"> • Are you using a disc that does not contain menus?
Aspect ratio cannot be changed.	<ul style="list-style-type: none"> • You can play 16:9 DVDs in 16:9 WIDE mode, 4:3 LETTER BOX mode, or 4:3 PAN SCAN mode, but 4:3 DVDs can be seen in 4:3 ratio only. Refer to the DVD disc jacket and then select the appropriate function.
Can't receive radio broadcast.	<ul style="list-style-type: none"> • Is the antenna connected properly? • If the antenna's input signal is weak, install an external FM antenna in an area with good reception.
<ul style="list-style-type: none"> • The main unit is not working. (Example: The power goes out or strange noise is heard.) • The DVD player is not working normally. 	<ul style="list-style-type: none"> • Turn off the power and hold the  button on the main unit for longer than 5 seconds. <p>Using the RESET function will erase all stored settings. Do not use this unless necessary.</p>
The password for rating level has been forgotten.	<ul style="list-style-type: none"> • While the player is in the stop mode, hold the main unit's  button for longer than 5 seconds. "INITIALIZE" appears on the display and all settings will return to the default values. • Press the POWER button. <p>Using the RESET function will erase all stored settings. Do not use this unless necessary.</p>

Cautions on Handling and Storing Discs

Small scratches on the disc may reduce sound and picture quality or cause skipping. Be especially careful not to scratch discs when handling them.

● Handling discs

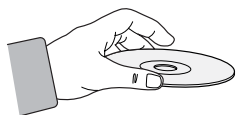

Do not touch the playback side of the disc.
Hold the disc by the edges so that fingerprints will not get on the surface.
Do not stick paper or tape on the disc.

● Disc Storage

<p>Do not keep in direct sunlight</p>	<p>Keep in a cool ventilated area</p>	<p>Keep in a clean Protection jacket. Store vertically.</p>
--	--	--

- Caution**
- Do not allow the discs to become contaminated with dirt.
 - Do not load cracked or scratched discs.

● Handling and Storing Discs



When you get fingerprints or dirt on the disc, clean it with a mild detergent diluted in water and wipe with a soft cloth.

- When cleaning, wipe gently from the inside to the outside of the disc.

Note



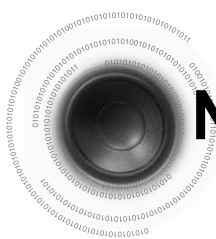

- Condensation may form if warm air comes into contact with cold parts inside the player. When condensation forms inside the player, the player may not operate correctly. If this occurs, remove the disc and let the player stand for 1 or 2 hours with the power on.

Specifications

GENERAL	Power Consumption	160W		
	Weight	15.9lbs		
	Dimensions (W x H x D)	14.2 x 2.6 x 14.5 inches		
	Operating Temperature Range	41°F ~ 95°F		
	Operating Humidity Range	10% ~ 75%		
WIRELESS REAR RECEIVER	Power Consumption	35W		
	Power output	60W x 2(8Ω)		
	Weight	3.3 lbs		
	Dimensions (W x H x D)	6.8 x 15.6 x 5.0 inches		
FM TUNER	Usable Sensitivity	10dB		
	S/N Ratio	60dB		
	Distortion	0.5%		
AM TUNER	Usable Sensitivity	54dB		
	S/N Ratio	40dB		
	Distortion	2%		
VIDEO INPUT	Component Video	Y:1.0Vp-p(75Ω load), Pr:0.70Vp-p(75Ω load) Pb:0.70Vp-p(75Ω load)		
	Composite Video	1.0Vp-p(75Ω load)		
VIDEO OUTPUT	Component Video	Y:1.0Vp-p(75Ω load) Pr:0.70Vp-p(75Ω load) Pb:0.70Vp-p(75Ω load)		
	S-VIDEO	Luminance Signal: 1.0Vp-p(75Ω load)		
		Color Signal: 0.286Vp-p(75Ω load)		
AMPLIFIER	Front speaker output	60W(8Ω)/CH		
	Center speaker output	60W(8Ω)		
	Rear speaker output	60W(8Ω)/CH		
	Subwoofer speaker output	100W(3Ω)		
	Frequency range	20Hz~20kHz		
	S/N Ratio	75dB		
	Channel separation	50dB		
Input sensitivity	(AUX)500mV			
SPEAKERS	Speaker system	5.1ch speaker system		
		Front/Center/Rear speaker	Subwoofer speaker	
	Impedance	8Ω x 5	3Ω	
	Frequency range	120Hz~20kHz	40Hz~250Hz	
	Output sound pressure level	84dB/W/M	86dB/W/M	
	Rated input	60W	100W	
	Maximum input	120W	200W	
	Dimensions (W x H x D)	Front/Rear	3.7 x 4.3 x 3.7 inches	9.6 x 15.9 x 13.1 inches
		Center	4.3 x 4.1 x 3.7 inches	
	Weight	Front/Rear	1.6 lbs	14.6 lbs
Center		1.7 lbs		



Notes on Terminology

ANGLE	Recorded onto some DVD discs are scenes which have been simultaneously shot from a number of different angles (the same scene is shot from the front, from the left, from the right, etc.). With such discs, the Angle button can be used to change the angle of view for specific scenes.
CHAPTER NUMBER	These numbers are recorded on DVD discs. A Title is subdivided into many sections, each of which is numbered, and specific parts of the video can be searched quickly using these numbers.
DVD	A high-density optical disc on which high-quality pictures and sound have been recorded by means of digital signals. Incorporating a new video compression technology (MPEG-2) and high-density recording technology, a DVD disc comprises two 0.6 mm thick discs bonded together.
PCM	An acronym for Pulse Code Modulation - another name for digital audio.
PBC (PLAYBACK CONTROL)	This is recorded on a video CD (version 2.0). Selected scenes or information can be chosen from the menu displayed on the TV monitor.
REGION NUMBER	Both the DVD player and DVD discs are encoded with a region number. If the region number on the DVD disc does not correspond to the region number of the DVD player, the player cannot play the disc.
SUBTITLES	Translated appearing at the bottom of the screen. A DVD disc can contain up to 32 subtitle languages.
TITLE NUMBER	These numbers are recorded on DVD discs. When a disc contains two or more movies, these movies are numbered as Title 1, Title 2, etc.
TRACK NUMBER	These numbers are assigned to the tracks which are recorded on video and audio CDs. They enable specific tracks to be located quickly.
VIDEO CD	Contains recordings of pictures and sound whose quality is roughly comparable to that of video tape. This player also supports video CDs with playback control (version 2.0).
	You can enjoy 5.1 (or 6) channels of high fidelity digital sound from various digital input sources such as DVD, CD etc. DTS provides a realistic, clear surround sound that has not previously been available from conventional surround sound.
	5.1 (or 6) Channel Digital Surround sound reproduced from DVDs and LDs recorded as a digital signals (with  disc marking). With better sound quality, dynamic range, and directionality than traditional Dolby surround technology, you can enjoy dynamic, realistic sound.
	A 4 channel analog sound reproduced from a program source such as a videotape or LD with the  mark. You can enjoy a more realistic, robust sound unavailable from regular stereo sources.

SAMSUNG

ELECTRONICS

Samsung Limited Warranty

Samsung Electronics Canada Inc. (SECA), warrants that this product is free from defective material and workmanship.

SECA further warrants that if this product fails to operate properly within the specified warranty period and the failure is due to improper workmanship or defective material SECA will repair or replace the product at its option.

All warranty repairs must be performed by a SECA authorized service centre. (The name and address of the location nearest you can be obtained by calling toll free **1-800-726-7864** or visiting our web site at **www.samsung.ca**)

Labour
one (1) year (carry-in)

Parts
one (1) year

On carry-in models, transportation to and from the service centre is the customer's responsibility.

The original dated sales receipt must be retained by the customer and is the only acceptable proof of purchase. It must be presented to the authorized service centre at the time service is requested.

Exclusions

This warranty does not cover damage due to accident, fire flood and/or other acts of God; misuse, incorrect line voltage, improper installation, improper or unauthorized repairs, commercial use, or damage that occurs in shipping. Exterior and interior finish, lamps and glass are not covered under this warranty. Customer adjustments which are explained in the instruction manual are not covered under the terms of this warranty. This warranty will automatically be voided for any unit found with a missing or altered serial number. This warranty is valid only on products purchased and used in Canada.

Free Manuals Download Website

<http://myh66.com>

<http://usermanuals.us>

<http://www.somanuals.com>

<http://www.4manuals.cc>

<http://www.manual-lib.com>

<http://www.404manual.com>

<http://www.luxmanual.com>

<http://aubethermostatmanual.com>

Golf course search by state

<http://golfingnear.com>

Email search by domain

<http://emailbydomain.com>

Auto manuals search

<http://auto.somanuals.com>

TV manuals search

<http://tv.somanuals.com>