

SAMSUNG

DIGITAL HOME THEATER SYSTEM

HT-DS400

HT-DS420

HT-DS403T

HT-DS420S

THIS APPLIANCE IS MANUFACTURED BY:

Instruction Manual

SAMSUNG

ELECTRONICS

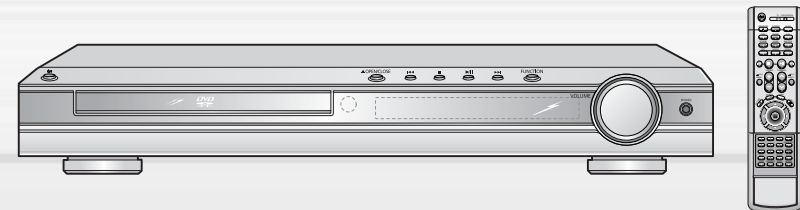

Safety Warnings

CLASS 1 LASER PRODUCT
KLASSE 1 LASER PRODUKT
LUOKAN 1 LASER LAITE
KLASS 1 LASER APPARAT
PRODUCTO LASER CLASE 1



CAUTION:
 TO REDUCE THE RISK OF ELECTRIC SHOCK, DO NOT REMOVE REAR COVER. NO USER SERVICEABLE PARTS INSIDE. REFER SERVICING TO QUALIFIED SERVICE PERSONNEL.

CLASS 1 LASER PRODUCT

This Compact Disc player is classified as a CLASS 1 LASER product.

(Saudi Arabian Standards Organisation)

THIS APPLIANCE IS FITTED WITH 220V SASO APPROVED PLUG. THE CUSTOMER IS ENTITLED TO A FREE SASO APPROVED 127 PLUG FROM THE LOCAL DEALER.

Use of controls, adjustments or performance of procedures other than those specified herein may result in hazardous radiation exposure.

CAUTION-INVISIBLE LASER RADIATION WHEN OPEN AND INTERLOCKS DEFEATED, AVOID EXPOSURE TO BEAM.



This symbol indicates that dangerous voltage which can cause electric shock is present inside this unit.



This symbol alerts you to important operating and maintenance instructions accompanying the unit.

WARNING: To reduce the risk of fire or electric shock, do not expose this appliance to rain or moisture.

CAUTION: TO PREVENT ELECTRIC SHOCK, MATCH WIDE BLADE OF PLUG TO WIDE SLOT, FULLY INSERT.

Precautions

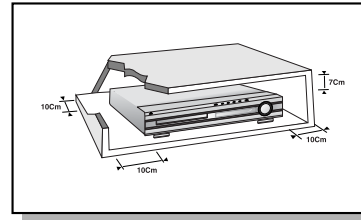

Ensure that the AC power supply in your house complies with the identification sticker located on the back of your player. Install your player horizontally, on a suitable base (furniture), with enough space around it for ventilation (3~4inches). Make sure the ventilation slots are not covered. Do not stack anything on top of the player. Do not place the player on amplifiers or other equipment which may become hot. Before moving the player, ensure the disc tray is empty. This player is designed for continuous use. Switching off the DVD player to the stand-by mode does not disconnect the electrical supply. In order to disconnect the player completely from the power supply, remove the main plug from the wall outlet, especially when left unused for a long period of time.

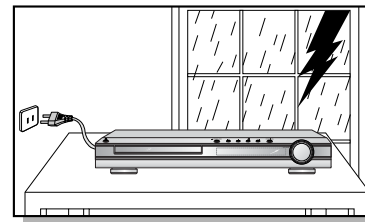
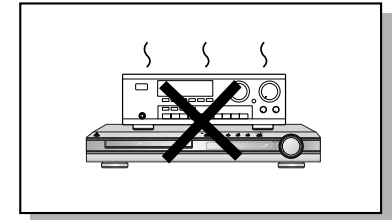

During thunderstorms, disconnect AC main plug from the wall outlet. Voltage peaks due to lightning could damage the unit.

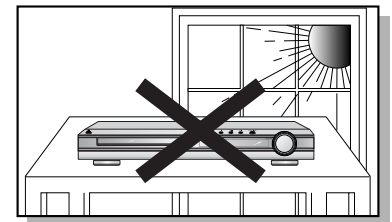

Do not expose the unit to direct sunlight or other heat sources. This could lead to overheating and malfunction of the unit.

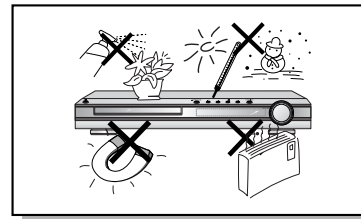

Protect the player from moisture (i.e. vases), and excess heat (e.g. fire-place) or equipment creating strong magnetic or electric fields (i.e. speakers...). Disconnect the power cable from the AC supply if the player malfunctions. Your player is not intended for industrial use. Use of this product is for personal use only. Condensation may occur if your player or disc have been stored in cold temperatures.

If transporting the player during the winter, wait approximately 2 hours until the unit has reached room temperature before using.

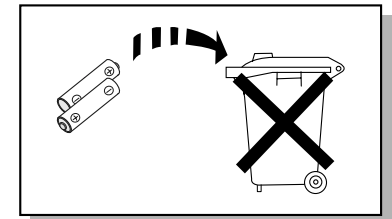

The battery used with this product contain chemicals that are harmful to the environment. Do not dispose of batteries in the general household trash.

Features

● Multi-Disc Playback & AM/FM Tuner

The HT-DS400/HT-DS420/HT-DS403T/HT-DS420S combines the convenience of multi-disc playback capability, including DVD-AUDIO, DVD-VIDEO, VCD, CD, MP3-CD, DivX, CD-R/RW, and DVD-R/RW, with a sophisticated AM/FM tuner, all in a single player.

● DVD-Audio compatible

Experience the super high-quality audio performance of DVD-Audio. The on-board 24-bit/192kHz DAC enables this player to deliver exceptional sound quality in terms of dynamic range, low-level resolution and high-frequency detail.

● Built-in 5.1-Channel Amplifier

The HT-DS400 / HT-DS420/ HT-DS403T/ HT-DS420S comes with a built-in 5.1-channel amplifier, allowing you to enjoy dynamic sound.

● Dolby Pro Logic II

Dolby Pro Logic II is a new form of multi-channel audio signal decoding technology that improves upon existing Dolby Pro Logic.

● DTS (Digital Theater Systems)

DTS is an audio compression format developed by Digital Theater Systems Inc. It delivers full-frequency 5.1 channel sound.

● TV Screen Saver Function

The HT-DS400 / HT-DS420 / HT-DS403T / HT-DS420S automatically brightens and darkens the brightness of the TV screen after 3 minutes in the stop mode. The HT-DS400 / HT-DS420 / HT-DS403T / HT-DS420S automatically switches itself into the power saving mode after 20 minutes in the screen saver mode.

● Power Saving Function

The HT-DS400 / HT-DS420 / HT-DS403T/ HT-DS420S automatically shuts itself off after 20 minutes in the stop mode.

● Customized TV Screen Display

The HT-DS400 / HT-DS420 / HT-DS403T/ HT-DS420S allows you to select your favorite image during JPEG, DVD, or VCD playback and set it as your background wallpaper.

Contents

● PREPARATION

Safety Warnings.....	1
Precautions.....	2
Features.....	3
Notes on Discs.....	5
Description.....	7

● CONNECTIONS

Connecting the Speakers.....	11
Connecting the Video Out to TV.....	13
P.SCAN(Progressive Scan) Function.....	14
Connecting External Components.....	15
Connecting the FM and AM Antennas.....	17
Before Using Your DVD Player.....	19

● OPERATION

Disc Playback.....	21
Checking the Remaining Time.....	23
MP3-CD Playback.....	24
JPEG File Playback.....	25
DivX Playback.....	27
Displaying Disc Information.....	29
Fast/Slow Playback.....	30
Skipping Scenes/Songs.....	31
Repeat Playback.....	32
A-B Repeat Playback.....	33
Angle Function.....	34
Zoom Function.....	35
Bonus Group / Navigating Pages.....	36
Selecting Audio/Subtitle Language.....	37
Moving Directly to a Scene/Song.....	38
Using Disc Menu.....	39
Using the Title Menu.....	40

● SETUP

Setting the Language.....	41
Setting TV Screen type.....	43
Setting Parental Controls (Rating Level).....	45
Setting the Password.....	47
Language Code List.....	48
Setting the Wallpaper.....	49
DVD Playback Mode.....	51
AV SYNC Steup.....	52
Setting the Speaker Mode.....	53
Setting the Test Tone.....	54
Setting the Delay Time.....	55
Setting the Audio Quality.....	57
Setting the DRC (Dynamic Range Compression).....	59
Sound Field (DSP)/EQ Function.....	60
Dolby Pro Logic II Mode.....	61
Dolby Pro Logic II Effect.....	62

● RADIO OPERATION

Listening to Radio.....	63
Presetting Stations.....	64

● MISCELLANEOUS

Convenient Functions.....	65
Operating a TV with the Remote Control.....	67
Before Calling for Service.....	69
Cautions on Handling and Storing Discs.....	71
Specifications.....	72
Notes on Terminology.....	74



Notes on Discs



DVD (Digital Versatile Disc) offers fantastic audio and video, thanks to Dolby Digital surround sound and MPEG-2 video compression technology. Now you can enjoy these realistic effects in the home, as if you were in a movie theater or concert hall.



DVD players and the discs are coded by region. These regional codes must match in order for the disc to play. If the codes do not match, the disc will not play. The Region Number for this player is given on the rear panel of the player. (Your DVD player will only play DVDs that are labeled with identical region codes.)

Playable Discs

Disc Type	Mark (Logo)	Recorded Signals	Disc Size	Max. Playing Time
DVD-AUDIO DVD-VIDEO		Audio + Video	12cm	Approx. 240 min. (single-sided) Approx. 480 min. (double-sided)
			8cm	Approx. 80 min. (single-sided) Approx. 160 min. (double-sided)
VIDEO-CD		Audio + Video	12cm	74 min.
			8cm	20 min.
AUDIO-CD		Audio	12cm	74 min.
			8cm	20 min.

Do not use the following types of disc!

- LD, CD-G, CD-I, CD-ROM and DVD-ROM cannot be played on this player. If such discs are played, a "WRONG DISC FORMAT" message appears on the TV screen.
- DVD discs purchased abroad may not play on this player. If such discs are played, a "WRONG REGION CODE" message appears on the TV screen.

Copy Protection

- Many DVD discs are encoded with copy protection. Because of this, you should only connect your DVD player directly to your TV, not to a VCR. Connecting to a VCR results in a distorted picture from copy-protected DVD discs.
- This product incorporates copyright protection technology that is protected by methods claims of certain U.S. patents and other intellectual property rights owned by Macrovision Corporation and other rights owners. Use of this copyright protection technology must be authorized by Macrovision Corporation, and is intended for home and other limited viewing uses only unless otherwise authorized by Macrovision Corporation. Reverse engineering or disassembly is prohibited.

Disc Recording Format

CD-R Discs

- Depending on the disc recording device (CD-Recorder or PC) and the condition of the disc, some CD-R discs may not be playable.
- Use a 650MB/74 minute CD-R. Avoid CD-R media, as they may not be playable.
- If possible, do not use CD-RW (Rewritable) media, as they may not be playable.
- Only the CD-Rs that are properly "closed" can be fully played. If the session is closed but the disc is left open, you may not be able to fully play the disc.

CD-R MP3 Discs

- Only CD-R discs with MP3 files in ISO 9660 or Joliet format can be played.
- MP3 file names should be 8 characters or less in length and contain no blank spaces or special characters (. / = +).
- Use discs recorded with a compression/decompression data rate greater than 128Kbps.
- Only files with the ".mp3" and ".MP3" extensions can be played.
- Only a consecutively written Multisession disc can be played. If there is a blank segment in the Multisession disc, the disc can be played only up to the blank segment.
- If the disc is not closed, it will take longer to begin playback and not all of the recorded files may be played.
- For files encoded in Variable Bit Rate (VBR) format, i.e. files encoded in both low bit rate and high bit rate (e.g., 32Kbps ~ 320Kbps), the sound may skip during playback.
- If more than 500 tracks are recorded on a single CD, a maximum of 500 tracks can be played.
- If more than 300 folders are recorded on a single CD, a maximum of 300 folders can be played.

CD-R JPEG Discs

- Only files with the ".jpeg" and ".JPEG" extensions can be played.
- If the disc is not closed, it will take longer to start playing and not all of the recorded files may be played.
- Only CD-R discs with JPEG files in ISO 9660 or Joliet format can be played.
- JPEG file names should be 8 characters or less in length and contain no blank spaces or special characters (. / = +).
- Only a consecutively written multisession disc can be played. If there is a blank segment in the multisession disc, the disc can be played only up to the blank segment.
- A maximum of 9,999 images can be stored on a single CD.
- When playing a Kodak/Fuji Picture CD, only the JPEG files in the picture folder can be played.
- Picture discs other than Kodak/Fuji Picture CDs may take longer to start playing or may not play at all.



Description

—Front Panel—

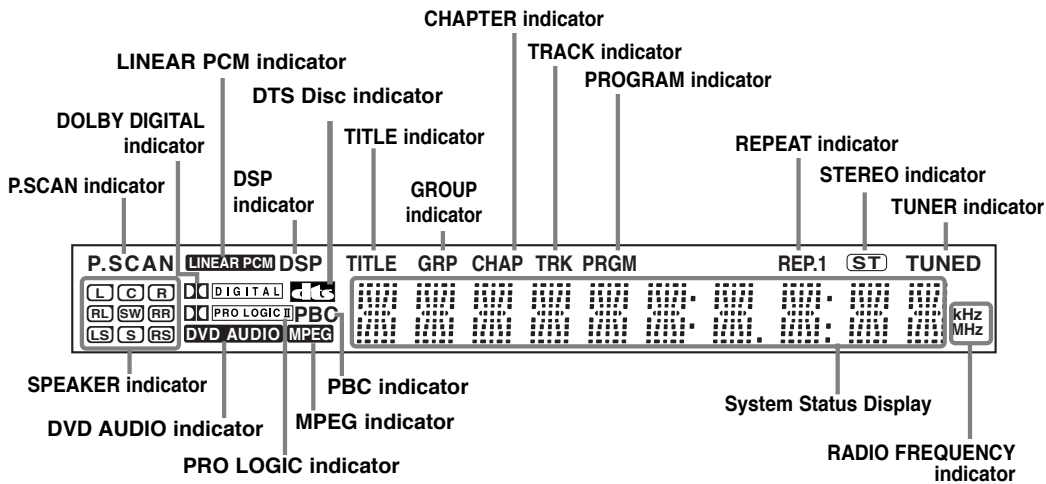
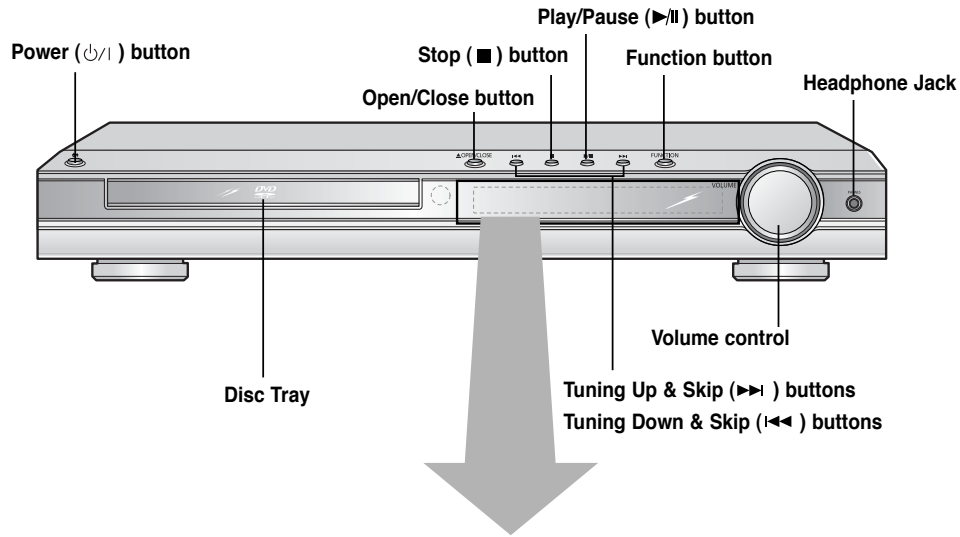

—Rear Panel—

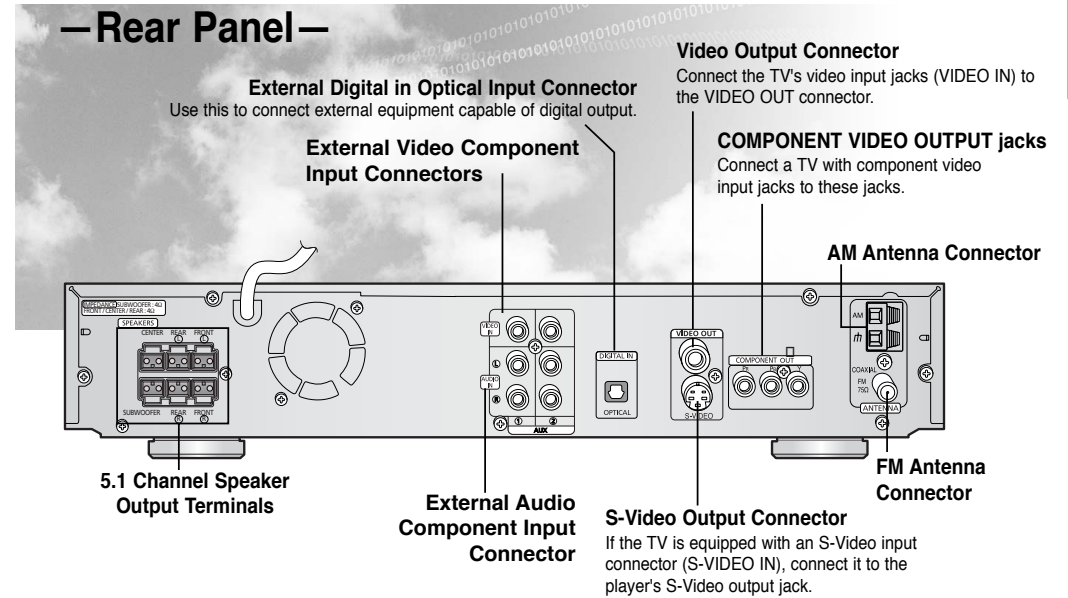

Accessories

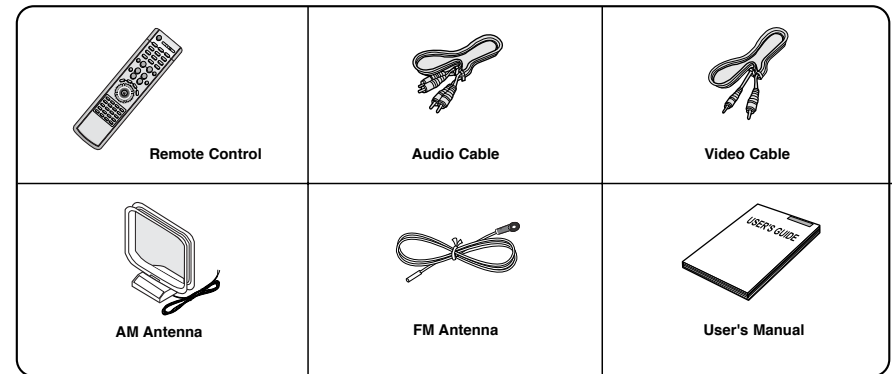

Description

—Remote Control—

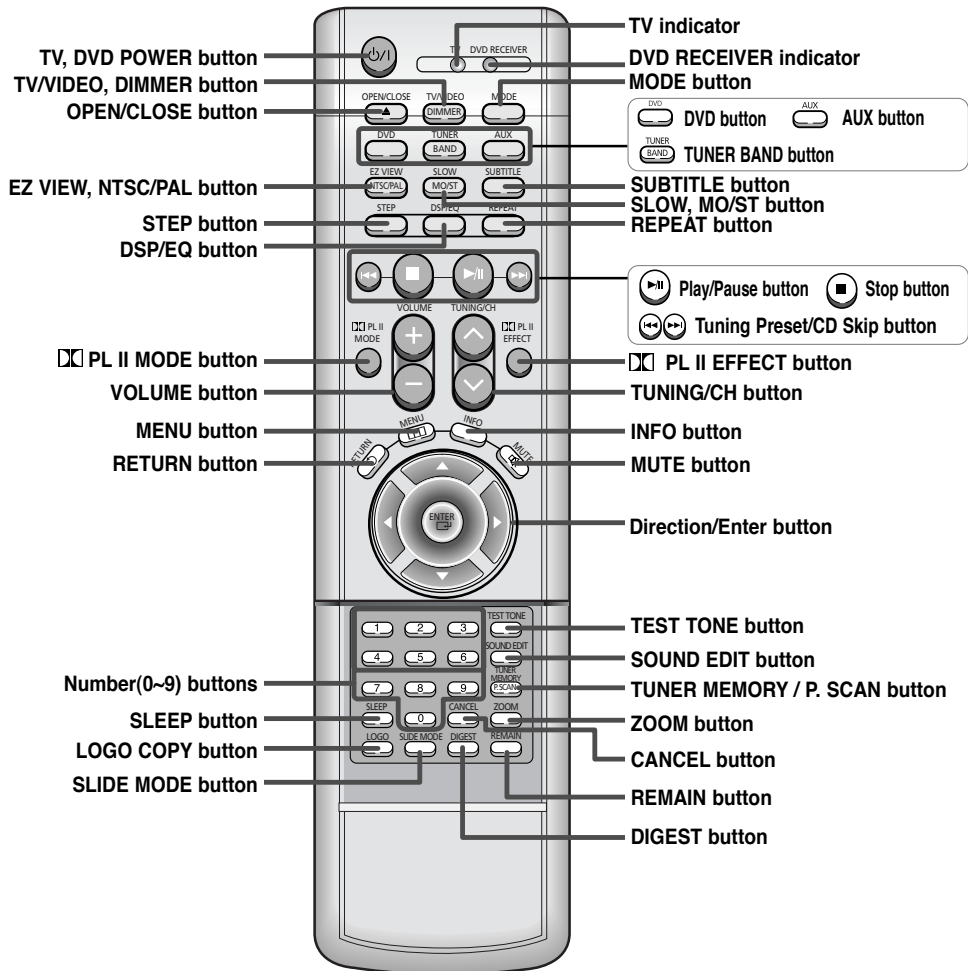

Insert Remote Batteries

- 1** Remove the battery cover on the back of the remote by pressing down and sliding the cover in the direction of the arrow.
- 2** Insert two 1.5V AAA batteries, paying attention to the correct polarities (+ and -).
- 3** Replace the battery cover.

Caution Follow these precautions to avoid leaking or cracking cells:

- Place batteries in the remote control so they match the polarity:(+) to (+)and (-)to (-).
- Use the correct type of batteries. Batteries that look similar may differ in voltage.
- Always replace both batteries at the same time.
- Do not expose batteries to heat or flame.

Range of Operation of the Remote Control

The remote control can be used up to approximately 23 feet/7 meters in a straight line. It can also be operated at a horizontal angle of up to 30° from the remote control sensor.

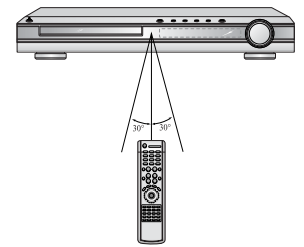

To open the remote control cover, push the top of the cover, then slide downward.

Connecting the Speakers

Before moving or installing the product, be sure to turn off the power and disconnect the power cord.

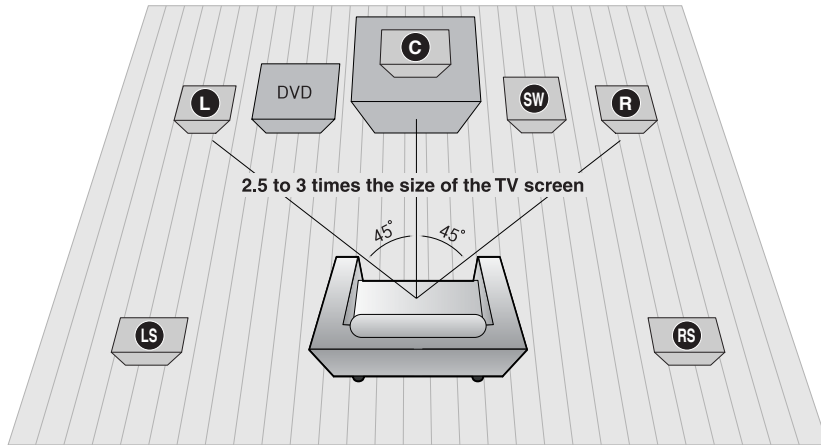

Position of the DVD Player

- Place it on a stand or cabinet shelf, or under the TV stand.

Selecting the Listening Position

The listening position should be located about 2.5 to 3 times the distance of the TV's screen size away from the TV. Example: For 32" TVs 2~2.4m (6~8feet)
For 55" TVs 3.5~4m (11~13feet)

Front Speakers **L R**

- Place these speakers in front of your listening position, facing inwards (about 45°) toward you.
- Place the speakers so that their tweeters will be at the same height as your ear.
- Align the front face of the front speakers with the front face of the center speaker or place them slightly in front of the center speakers.

Center Speaker **C**

- It is best to install it at the same height as the front speakers.
- You can also install it directly over or under the TV.

Rear Speakers **LS RS**

- Place these speakers behind your listening position.
- If there isn't enough room, place these speakers to face each other.
- Place them about 60 to 90cm (2 to 3feet) above your ear, facing slightly downward.
- ★ Unlike the front and center speakers, the rear speakers are used to handle mainly sound effects and sound will not come from them all the time.

Subwoofer **SW**

- The position of the subwoofer is not so critical. Place it anywhere you like.
- Usually, it is placed by a corner near the front speakers.

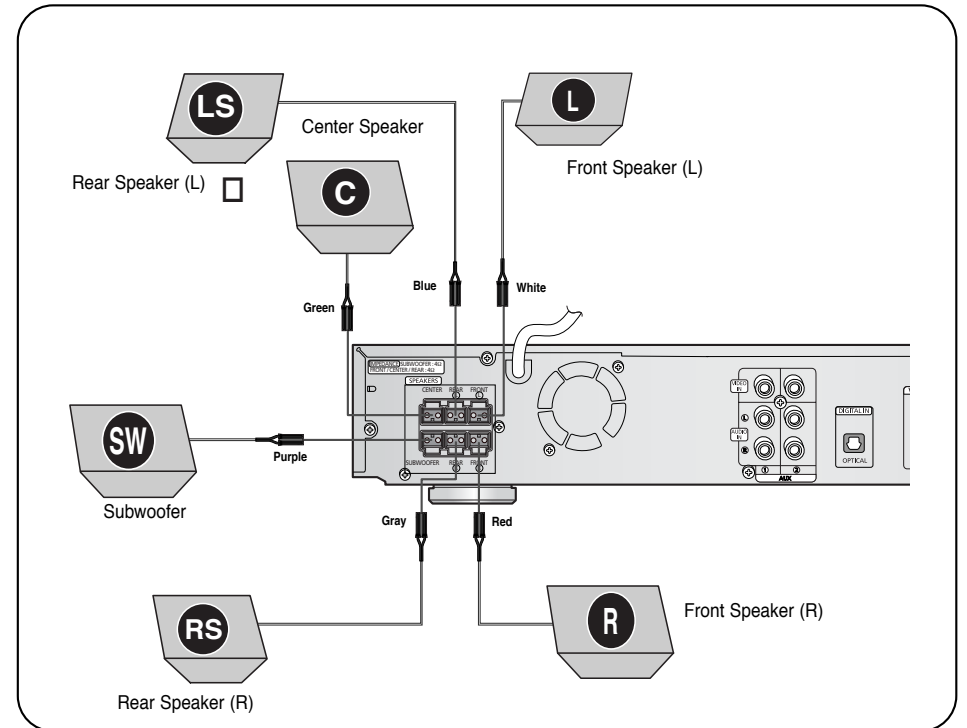

Back of the Speakers

- Press down the terminal tab on the back of the speaker.

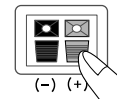

- Insert the wire into the terminal and release the terminal tab.

- Insert the black wire into the black (-) terminal and the gray wire into the gray (+) terminal.
- Make sure the polarities (+ and -) are correct.

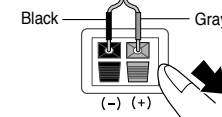

Back of the Main Unit

- Connect the connecting jacks to the back of the DVD player.

- Make sure the colors of the speaker terminals match the colors of the connecting jacks.
- Make sure the polarities (+ and -) are correctly.

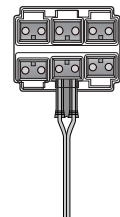

Connecting the Video Out to TV

Make sure that turn off and disconnect the plug from outlet before moving or installing the product. In connecting to video, select one of following three methods that suits for TV and connect it.

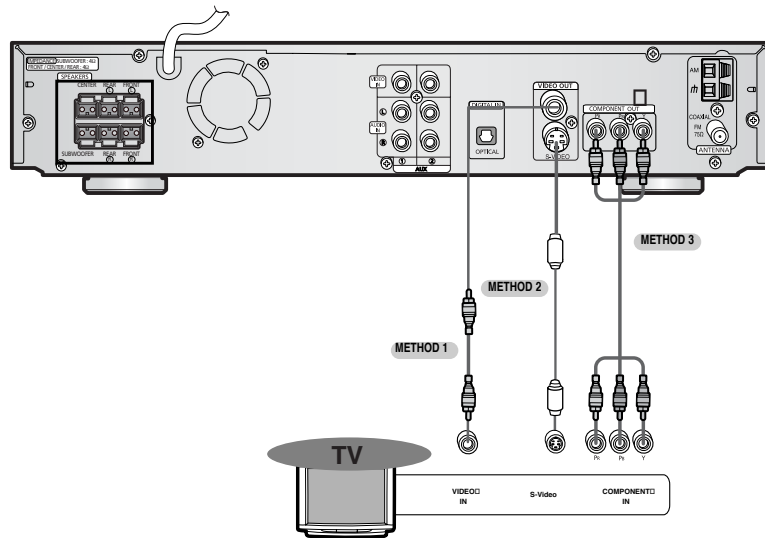

METHOD 1 Composite Video Good Quality

Connect the supplied video cable from the VIDEO OUT jack on the back panel of the system to the VIDEO IN jack on your television.

METHOD 2 S-Video Better Quality

If you television is equipped with an S-Video input, connect an S-Video cable (not supplied) from the S-VIDEO OUT jack on the back panel of the system to the S-VIDEO IN jack on your television.

METHOD 3 Component (Progressive Scan) Video Best Quality

If your television is equipped with Component Video inputs, connect a component video cable (not supplied) from the Pr, Pb and Y jacks on the back panel of the system to the corresponding jacks on your television.

Note • When the Progressive scan mode is selected, the VIDEO and SCART outputs do not feed any signal. See page 14 to select Progressive Scan.

P.SCAN(Progressive Scan) Function

Unlike regular Interlace Scan, in which two fields of picture information alternate to create the entire picture (odd scan lines, then even scan lines), Progressive Scan uses one field of information (all lines displayed in one pass) to create a clear and detailed picture without visible scan lines.

1 Press STOP button.

- When disc is played back, press the **STOP** button twice so that "STOP", appears on the display.

2 Press and hold P.SCAN button on the remote control for over 5 seconds.

- Pressing and holding the button for over 5 seconds will select "Progressive Scan" and "Interlace Scan" repetitively.
- When you select P.SCAN, "P.SCAN" will appear on the display

What is Progressive (or Non-Interlaced) Scanning?

Interlaced Scan (1 FRAME = 2 FIELDS)

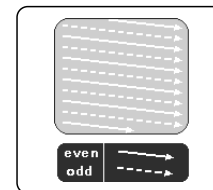

In interlaced-scan video, a frame consists of two interlaced fields (odd and even), where each field contains every other horizontal line in the frame. The odd field of alternating lines is displayed first, and then the even field is displayed to fill in the alternating gaps left by the odd field to form a single frame. One frame, displayed every 1/30th of a second, contains two interlaced fields, thus a total of 60 fields are displayed every 1/60th of a second. The interlaced scanning method is intended for capturing a still object.

Progressive Scan (FULL FRAME)

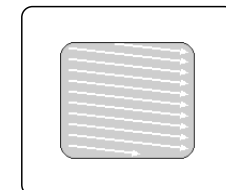

The progressive scanning method scans one full frame of video consecutively down the screen, line by line. An entire image is drawn at one time, as opposed to the interlaced scanning process by which a video image is drawn in a series of passes. The progressive scanning method is desirable for dealing with moving objects.

Note

- This function works only on TVs equipped with component video inputs (Y, Pr, Pb) that support Progressive Video. (It does not work on TVs with conventional component inputs, i.e., non-progressive scan TVs.)
- Depending on the brand and model of your TV, this function may not work.

Selecting the Video Format

Press and hold **NTSC/PAL** button on the remote controller for over 5 seconds while the power is turned off.

- "NTSC" or "PAL" will appear in the display. At this time, press the **NTSC/PAL** button shortly to select between "NTSC" and "PAL".
- Each country has a different video format standard.
- For normal playback, the video format of the disc must be the same as the video format of your TV.



Connecting External Components

Connecting an External Digital Component

Example: Digital signal components such as a Set-Top Box or CD Recorder.

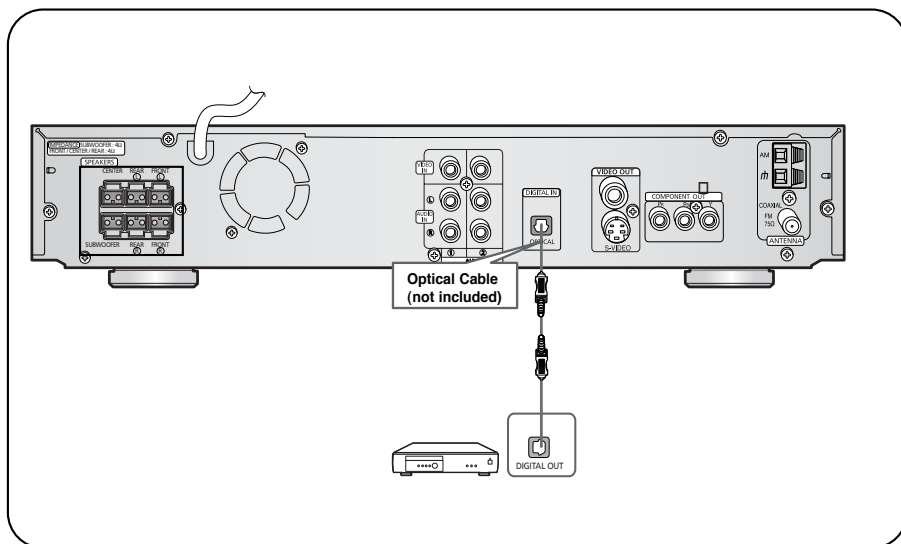

1 Connect the Digital Input (OPTICAL) to the Digital Output on the external digital component.

2 Press **AUX** on the remote control to select 'DIGITAL IN'.

- Each time the button is pressed, the selection changes as follows: DIGITAL IN → AUX 1 → AUX 2.
- You can also use the **FUNCTION** button on the main unit.

The mode switches as follows: DVD/CD → DIGITAL IN → AUX1 → AUX2 → FM → AM.

Connecting an External Analog Component

Example: Analog signal components such as a VCR or TV.

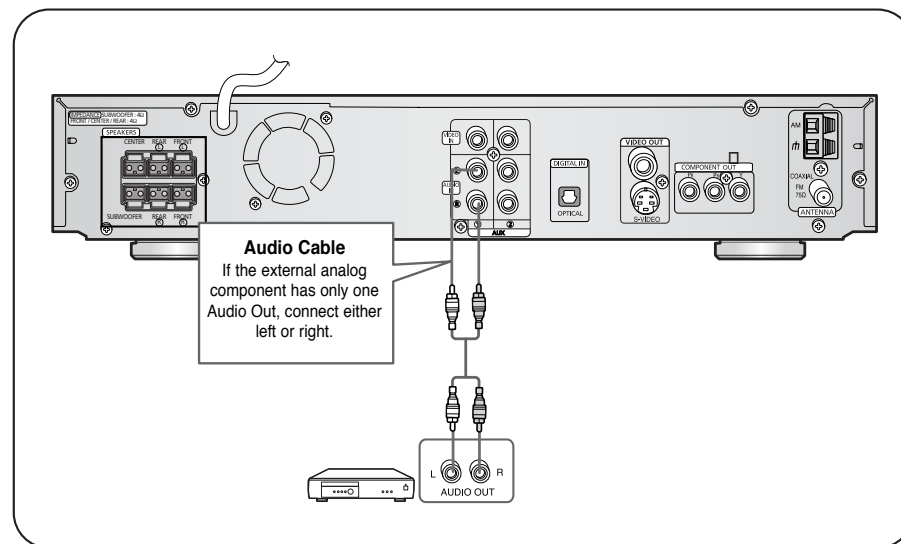

1 Connect Audio In on the DVD player to Audio Out on the external analog component.

- Be sure to match connector colors.

2 Press **AUX** on the remote control to select AUX 1 or AUX 2.

- Each time the button is pressed, the selection changes as follows: DIGITAL IN → AUX 1 → AUX 2.
- You can also use the **FUNCTION** button on the main unit.

The mode switches as follows: DVD/CD → DIGITAL IN → AUX1 → AUX2 → FM → AM.



Connecting the FM and AM Antennas

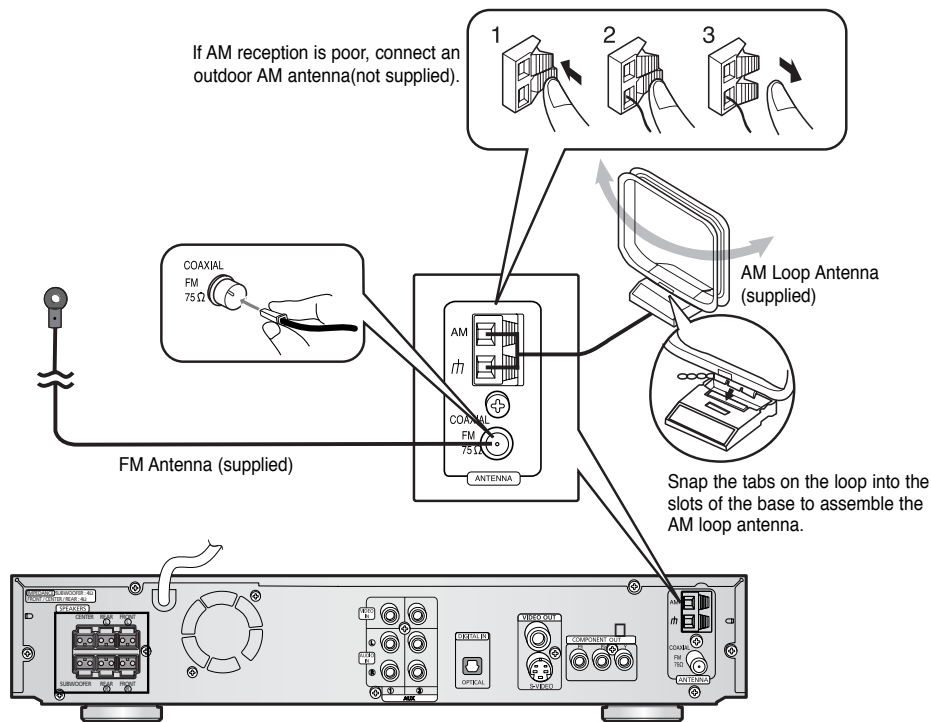

FM antenna connection

1. Connect the FM antenna supplied to the FM 75Ω COAXIAL terminal as a temporary measure.
2. Slowly move the antenna wire around until you find a location where reception is good, then fasten it to a wall or other rigid surface.

AM antenna connection

1. Connect the AM loop antenna supplied to the AM and π terminals.
2. If reception is poor, connect an outdoor single vinyl-covered wire to the AM terminal. (Keep the AM loop antenna connected).

• If reception is poor, connect an outdoor antenna.

Before attaching a 75Ω coaxial cable (with a standard type connector), disconnect the supplied FM antenna.

Cooling Fan

The cooling fan dissipates the heat generated inside the unit so that the unit can be operated normally. The cooling fan is activated automatically to supply cool air to the unit.

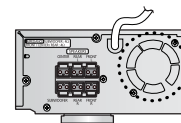

Please observe the following cautions for your safety.

- Make sure the unit is well-ventilated. If the unit has poor ventilation, the temperature inside the unit could rise and may damage it.
- Do not obstruct the cooling fan or ventilation holes. (If the cooling fan or ventilation holes are covered with a newspaper or cloth, heat may build up inside the unit and fire may result.)

Before Using Your DVD Player

Your DVD player is capable of playing DVD, VCD, CD, MP3 and JPEG discs. Depending on the disc you are using, these instructions may vary slightly. Read the instructions carefully before using.

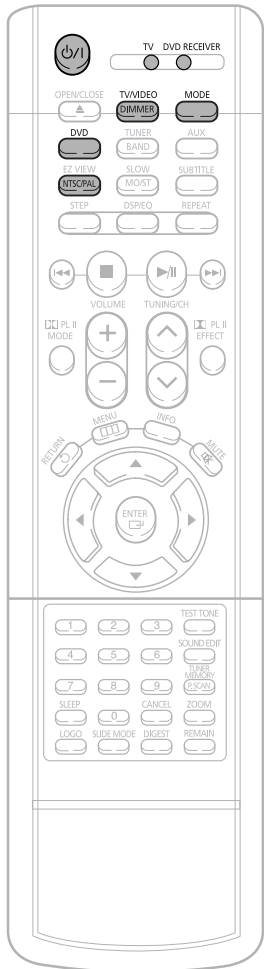

1 Plug the power cord into the AC power supply.

4 Press **TV/VIDEO** button to select VIDEO mode.



Selecting the Video Format

While the player is turned off, hold the NTSC/PAL down for longer than 5 seconds.

- By default, the video format is set to "PAL".
- Each time the button is pressed for longer than 5 seconds, the video format switches between "NTSC" and "PAL".
- Each country has a different video format standard.
- For normal playback, the video format of the disc must be the same as the video format of your TV.

2 Press the **MODE** button so that the TV indicator on the remote control flashes.

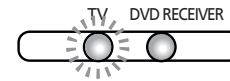

5 Press the **MODE** button so that the DVD RECEIVER indicator on the remote control flashes.

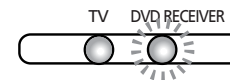

3 Press the **POWER** button to turn on the TV.



6 Press **DVD** button to select DVD/CD mode.

To Operate the TV and DVD Player with a Single Remote Control

Press **MODE** button.

- Each time the button is pressed, the TV indicator (red) and the DVD Receiver indicator (green) will flash alternately.
- You can operate the TV while the TV indicator is flashing and the DVD player while the DVD indicator is flashing.
- Buttons Enabled for TV Operation: POWER, CHANNEL, VOLUME, TV/VIDEO and Numeric (0-9) buttons.
- By default, the remote control is set to work with Samsung TVs.
See page 69 for more information on the operation of the remote control.



Disc Playback

1 Press **OPEN/CLOSE** button to open the disc tray.

2 Load a discs.

- Place a disc gently into the tray with the disc's label facing up.

3 Press **OPEN/CLOSE** button to close the disc tray.

DVD VCD CD

- Playback starts automatically.

Note

- Depending on the content of the disc, the initial screen may appear different.
- Depending on the recording mode, some MP3-CDs cannot be played.
- Table of contents of a MP3-CD varies depending on the MP3 track format recorded on the disc.

To stop playback, press **STOP** during playback.

- If pressed once, "PRESS PLAY" is displayed and the stop position will be stored in memory. If **PLAY/PAUSE** (▶/||) button or **ENTER** button is pressed, playback resumes from the stop position. (This function works only with DVDs.)
- If pressed twice, "STOP" is displayed, and if **PLAY/PAUSE** (▶/||) button is pressed, playback starts from the beginning.

To temporarily pause playback, press **PLAY/PAUSE** during playback.

- To resume playback, press **PLAY/PAUSE** (▶/||) button again.

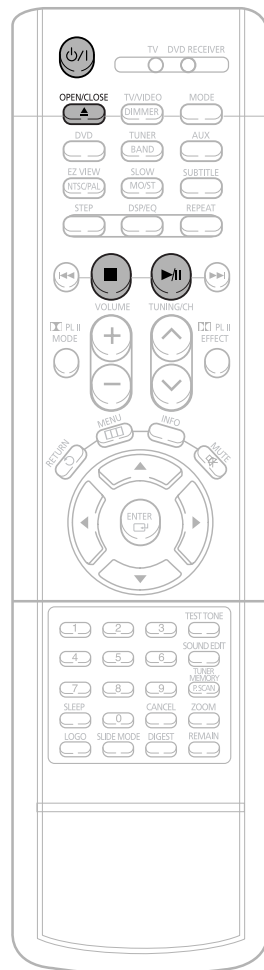

Disc terminology

Groups and tracks (DVD-AUDIO)

- DVD-audios are divided into several large sections called "groups" and smaller sections called "tracks". Numbers are allotted to these sections. These numbers are called "group numbers" and "track numbers".

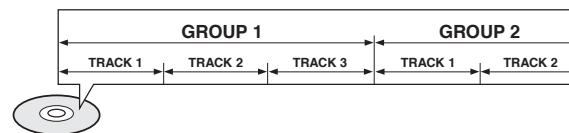

Titles and chapters (DVD-VIDEO)

- DVD-videos are divided into several large sections called "titles" and smaller sections called "chapters". Numbers are allotted to these sections. These numbers are called "title numbers" and "chapter numbers".

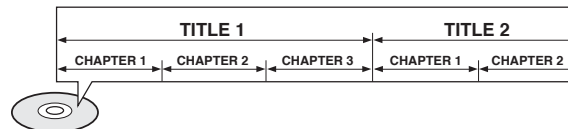

Tracks (Video and music CDs)

- Video and music CDs are divided into sections called "tracks". Numbers are allotted to these sections. These numbers are called "track numbers".

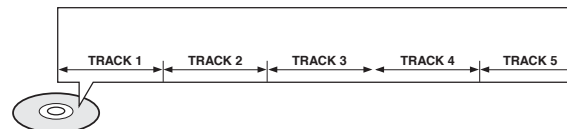

- Note**
- In this manual, the instructions marked with "DVD (DVD)" are applicable to DVD-VIDEO, DVD-AUDIO, and DVD-R/RW discs. Where a particular DVD type is mentioned, it is indicated separately.
 - Depending on the content of the disc, the initial screen may appear different.

Checking the Remaining Time

MP3-CD Playback

Data CDs (CD-ROM, CD-R, CD-RW) encoded in MP3 format can be played.

Press the REMAIN button.

- For checking the total and remaining time of a title or chapter being played.

Each time the REMAIN button is pressed

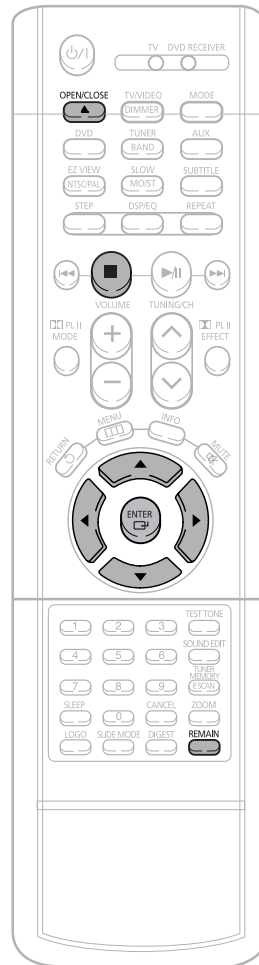
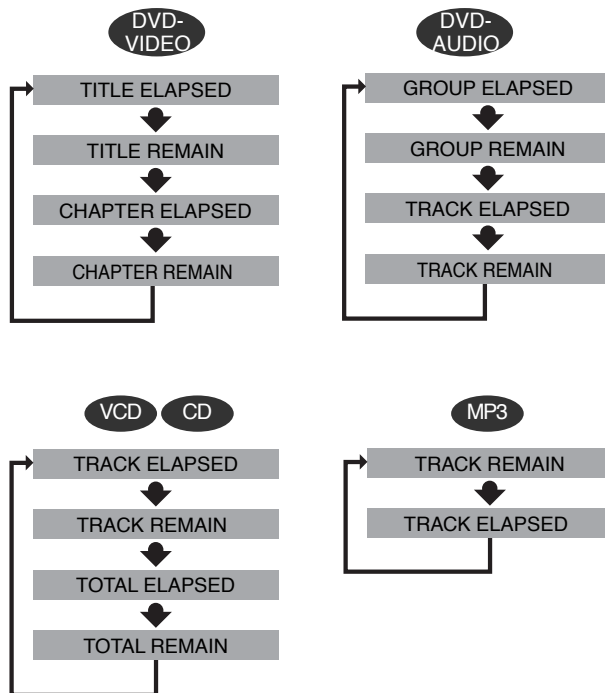

1 Press the **OPEN/CLOSE** button to open the disc tray, and then load the MP3 disc.

- The MP3 menu screen will appear and playback will start.
- Depending on the MP3 disc, the appearance of the menu may be different.



2 In Stop mode, use ◀ ▶ ▲ ▼ to select the album, and then press the **ENTER** button.

3 To change the album, use ◀ ▶ ▲ ▼ to select another album in Stop mode, and then press the **ENTER** button.

- To select another album and track, repeat Steps 2 and 3 above.

4 Press the **STOP** button to stop playback.

- Note**
- Depending on the recording mode, some MP3-CDs may not play.
 - Table of contents of a MP3-CD varies depending on the MP3 track format recorded on the disc.

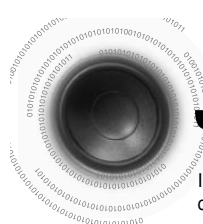

JPEG File Playback JPEG

Images captured with a digital camera or camcorder, or JPEG files on a PC can be stored on a CD and then played back with this DVD player.

Slide Mode

1 Place the JPEG disc on the disc tray.

2 Press the **OPEN/CLOSE** button.

3 Press **SLIDE MODE** button.

- Playback starts automatically.
- Each time the button is pressed, the image makes the transition as follows:

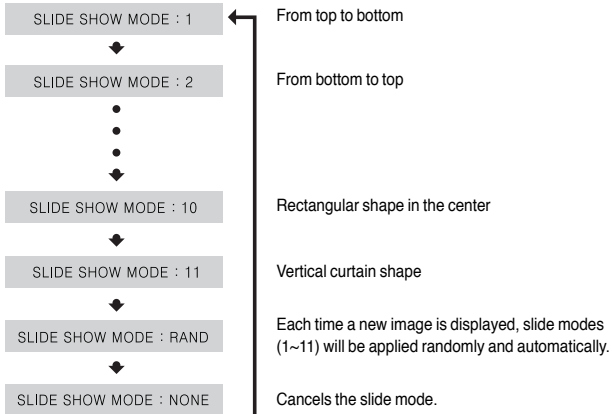

Press **◀▶▶▶** to skip to the next slide.

- Each time the button is pressed, the slide moves backward or forward.

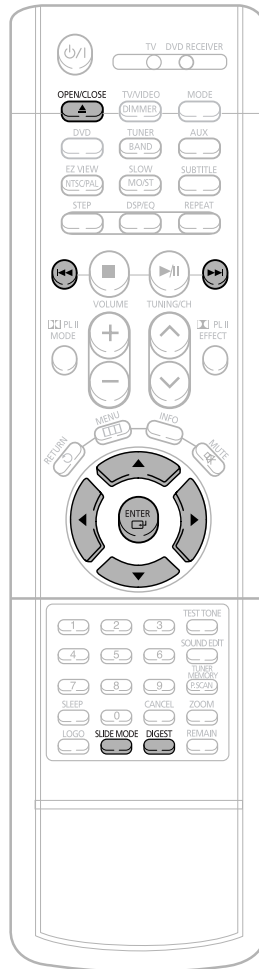

Digest Function

You can view 9 JPEG images on the TV screen.

1 Press **DIGEST** button during playback.

- JPEG files will be shown in 9 windows.



2 Press Cursor **▲, ▼, ◀, ▶** buttons to select the desired image and then press **ENTER** button.

- The selected image is played for 5 seconds before moving to the next image.



To view the previous or next image with 9 windows, press **◀◀▶▶▶▶**.

Rotate/Flip Function

Press Cursor **▲, ▼, ◀, ▶** buttons during playback.

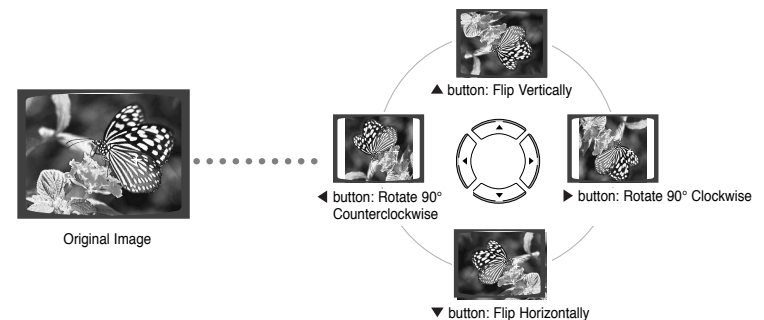



DivX Playback

Skip Forward/Back

During playback, press the **⏮️⏭️** button.

- Go to the next file whenever you press **⏭️** button, if there are over 2 files in the disk.
- Go to the previous file whenever you press **⏮️** button, if there are over 2 files in the disk.

Fast playback

Press and hold **⏮️⏭️** button.

- Each time the button is held down during playback, the playback speed changes as follows:

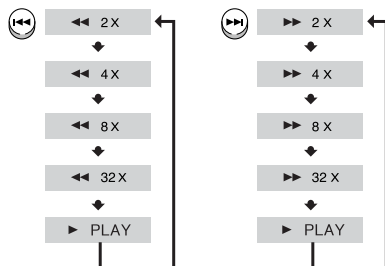

Zoom Function

1 Press **ZOOM** button.

- Each time you press the button, your selection will toggle between "ZOOM X2" and "ZOOM OFF".

2 Press Cursor **▲, ▼, ◀, ▶** buttons to move to the area you want to enlarge.

Note • DivX files can be played in Zoom X2 mode only.

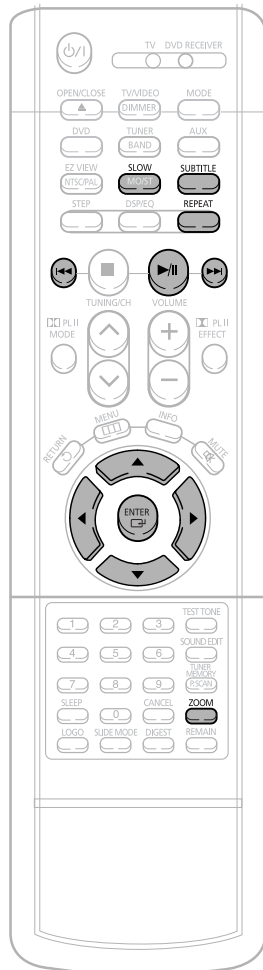

5 Minute Skip function

During playback, press the **◀, ▶** button.

- Go to the screen about 5 minutes after whenever you press **▶** button.
- Go to the screen about 5 minutes earlier whenever you press **◀** button.

Subtitle Display

Press the **SUBTITLE** button.

- Each time you press the button, your selection will toggle between "SUBTITLE ON" (1/1, 1/2 ...) and "SUBTITLE OFF".
- If the disc has only one subtitle file, it will be played automatically.

If the disc has more than one subtitle file

If the disc has more than one subtitle file, the default subtitle may not match the movie and you will have select your subtitle language as follows:

1 In Stop mode, press the **▲, ▼, ◀, ▶** button, select the desired subtitle () from the TV screen, and then press the **ENTER** button.

2 When you select the desired DivX file from the TV screen, the movie will be played normally.

DivX Feature Table

DivX Supported

Avi files are used to contain the audio and video data; these must be stored on CD in the ISO 9660 format.

		SPEC
VIDEO Compatibility	DivX3.11	Up to the latest VERSION
	WMV	WMV V1/V2/V3/V7
	Screen Size	720~576
AUDIO Compatibility	MP3	CBR : 80kbps~320kbps
	AC3	CBR : 128kbps~384kbps
	WMA	CBR : 56kbps~160kbps

MPEGs containing DivX can be divided into Video and Audio.

- **Video compatibility** : All versions of DivX later than 3.11 (including the latest 5.1) are supported. In addition, XviD is supported. For WMV, V1, V2, V3, and V7 formats are possible.

- **Audio compatibility** : MP3s encoded at bitrates from 80kbps to 320kbps, AC3s from 128kbps to 384kbps, and WMAs from 56kbps to 160kbps are supported.

- **In addition, for subtitles, this unit will support Text format (SML).**

Note

- When playing the DivX disk, you can play the file with extension of AVI only.
- Among the available DivX audio formats, DTS Audio is not supported.
- WMV V8 is not supported for WMV files.
- When burning a subtitle file to a CD-ROM with your PC, be sure to burn it as an SML file.
- DivX Disc does not playing when its sampling frequency is lower than 32kHz.
- Some of the discs recorded in DivX or XviD depending on the way of recording could be played back not correctly or couldn't be played back at all.

Displaying Disc Information

You can view disc playback information on the TV screen.

Press **INFO** button.

- Each time the button is pressed, the display changes as follows:

DVD



Display disappears

VCD CD



Display disappears

MP3 DivX JPEG



Display disappears

- appears on the TV screen!

If this symbol appears on the TV screen while buttons are being operated, that operation is not possible with the disc currently being played.

- What is a Group?**
A movie contained in a DVD-AUDIO disc.
- What is a Title?**
A movie contained in a DVD-VIDEO disc.
- What is a Chapter?**
Each title on a DVD disc is divided into several smaller sections called "chapters".
- What is a Track (File)?**
A section of video or a music file recorded on a DVD-AUDIO, CD, or MP3-CD.

Note

- Depending on the disc, the disc information display may appear different.
- Depending on the disc, you can also select DTS, DOLBY DIGITAL, or PRO LOGIC.

Screen Display

DVD display	DivX display	CHAPTER display	REPEAT PLAYBACK display	LR STEREO (L/R) display
VCD display	DVD-AUDIO display	TRACK (FILE) display	AUDIO LANGUAGE display	DOLBY DIGITAL display
CD display	TITLE display	ELAPSED TIME display	SUBTITLE display	ANGLE display
MP3 CD display	GROUP display			

Fast/Slow Playback

Fast Playback **DVD VCD CD MP3**

Press and hold .

- Each time the button is held down during playback, the playback speed changes as follows:

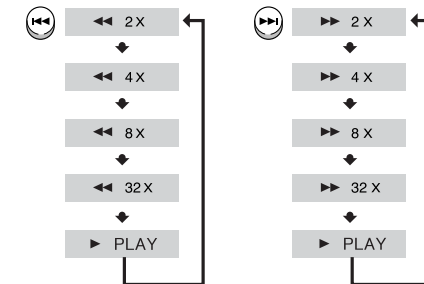

Slow Playback

Press **SLOW** button.

- Each time the button is pressed during playback, the playback speed changes as follows:

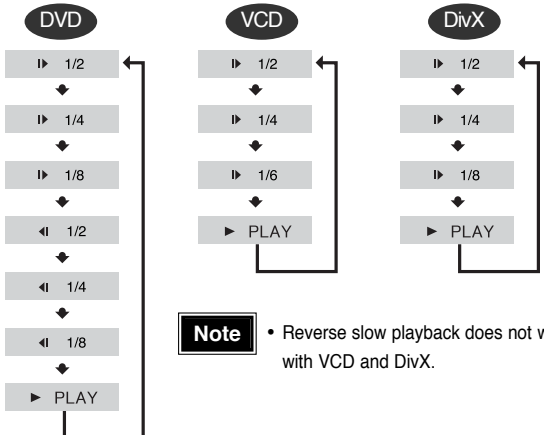

- Note** • Reverse slow playback does not work with VCD and DivX.

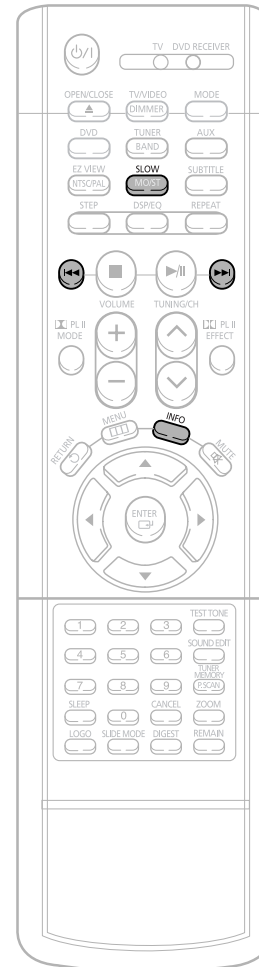

Skipping Scenes/Songs

DVD VCD MP3

Briefly press **◀◀▶▶**.

- Each time the button is pressed briefly during playback, the previous or next chapter, track, or directory (file) will be played.
- You cannot skip chapters consecutively.

DVD



VCD



MP3



- When watching a VCD with a track longer than 15 minutes, each time **◀◀▶▶** is pressed, playback will skip back or forward 5 minutes.

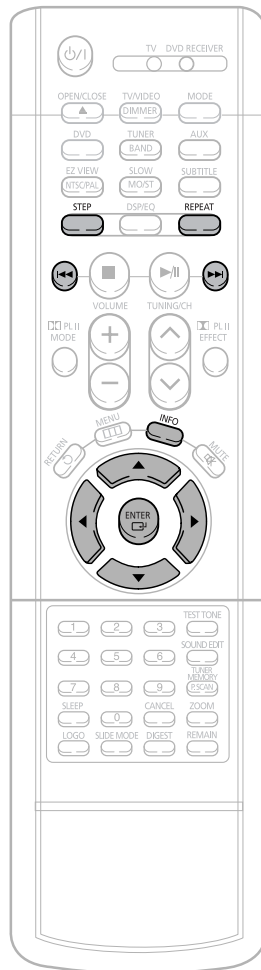

Playing Frame by Frame **DVD VCD**

Press **STEP** button.

- The picture moves forward one frame each time the button is pressed during playback.



Note

- During fast playback of a CD or MP3-CD, sound is heard only at 2x speed, and not at 4x, 8x, and 32x speeds.
- No sound is heard during slow playback and step motion playback.

Repeat Playback

DVD VCD CD MP3 JPEG

Press **REPEAT** button.

- Each time the button is pressed during playback, the repeat playback mode changes as follows:

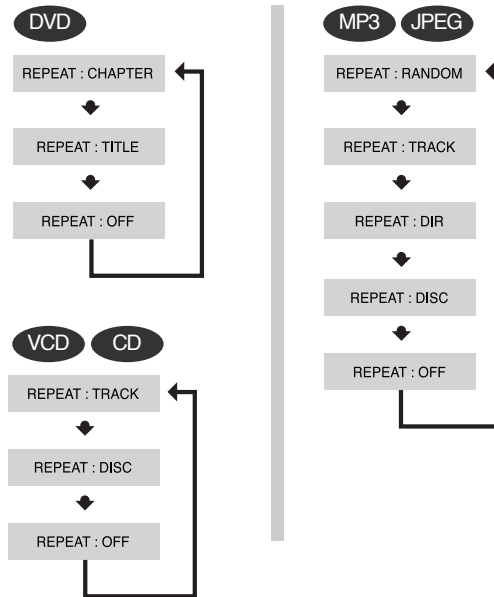

Repeat Playback Options

- **CHAPTER**
Repeatedly plays the selected chapter.
- **TITLE**
Repeatedly plays the selected title.
- **RANDOM**
Plays tracks in random order. (A track that has already been played may be played again.)
- **TRACK**
Repeatedly plays the selected track.
- **DIR**
Repeatedly plays all tracks in the selected folder.
- **DISC**
Repeatedly plays the entire disc.
- **OFF**
Cancels Repeat Playback.

To Select a Repeat Playback Mode in the Disc Information Screen

- 1 Press **INFO** button twice.
- 2 Press Cursor **▶** button to move to REPEAT PLAYBACK (⌂) display.
- 3 Press Cursor **▼** button to select the desired Repeat Playback mode.
- 4 Press **ENTER** button.



* For MP3 and JPEG discs, you cannot select Repeat Play from the information display screen.

Note

- Repeat playback operation is not possible with version 2.0 VCD discs if PBC is turned on. To use Repeat Playback on a VCD with PBC, you should set the PBC to OFF in the disc menu. (See page 39.)

A-B Repeat Playback

DVD VCD CD

1 Press **INFO** button twice.

- For a VCD or CD, press **INFO** button once.

DVD EN 1/3 OFF/ 02

2 Press **Cursor** **▶** button to move to **REPEAT PLAYBACK** (↻) display.

DVD EN 1/3 OFF/ 02

3 Press **Cursor** **▲**, **▼** buttons to select 'A-' and then press **ENTER** button at the beginning of the desired segment.

- When **ENTER** button is pressed, the selected position will be stored in memory.

DVD EN 1/3 OFF/ 02 A-



DVD EN 1/3 OFF/ 02 A-?

REPEAT : A-

4 Press **ENTER** button at the end of the desired segment.

- The specified segment will be played repeatedly.

DVD EN 1/3 OFF/ 02 A-B

REPEAT : A-B

To return to normal playback, press **Cursor** **▲**, **▼** buttons to select **↻ OFF**.

Note

- The A-B Repeat function will not work on an MP3 or JPEG disc.

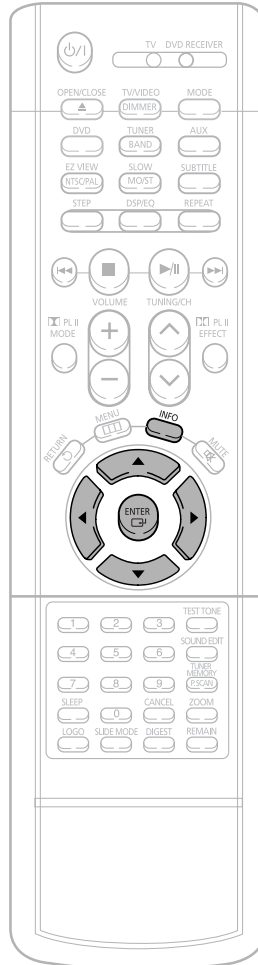

Angle Function

This function allows you to view the same scene in different angles.

DVD

1 Press **INFO** button.

DVD 01/01 001/040 0:00:37 1/3

2 Press **Cursor** **▶** button to move to **ANGLE** (⌂) display.

DVD 01/01 001/040 0:00:37 1/3

3 Press **Cursor** **▲**, **▼** or numeric buttons to select the desired angle.

- Each time the button is pressed, the angle changes as follows:



Note

- The Angle function works only with discs on which multiple angles have been recorded.

Zoom Function

This function allows you to enlarge a particular area of the displayed image.

Zoom (Screen Enlarge) Function

DVD VCD

1 Press **ZOOM** button.

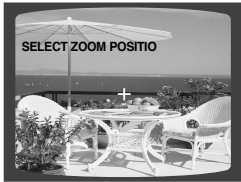

2 Press Cursor **▲**, **▼**, **◀**, **▶** buttons to move to the area you want to enlarge.



3 Press **ENTER** button.

- Each time the button is pressed, the zoom level changes as follows:

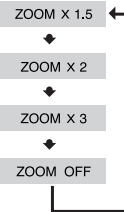

Aspect Ratio

DVD

Press **EZ VIEW** button.

- Each time the button is pressed, the zoom function will switch between On and Off.
- When a movie is played in Widescreen format, black bars at the top and bottom of the TV screen can be removed by pressing the **EZ VIEW** button.



Note

- This function will not work if the DVD is recorded with multi-camera angle format.
- Black bars may not disappear because some DVD discs have a built-in horizontal to vertical ratio.

Bonus Group / Navigating Pages

Bonus Group

DVD-AUDIO

Some DVD-Audio discs have an extra 'bonus' group that requires a 4-digit key number to access. See the disc packaging for details and the-key number.

When you play a DVD-Audio disc that has a bonus group, the key number input screen appears automatically.

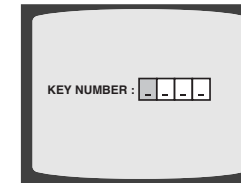

Note

- If you eject the disc, switch the power off, or unplug the player, you will need to re-enter the key number.

Navigating Pages

DVD-AUDIO

During playback, press the **TUNINGSICH** button on the remote control.

- You can select the desired image from a DVD-Audio disc containing still images.
- With some discs, you may not be able to select images depending on how the disc was manufactured.

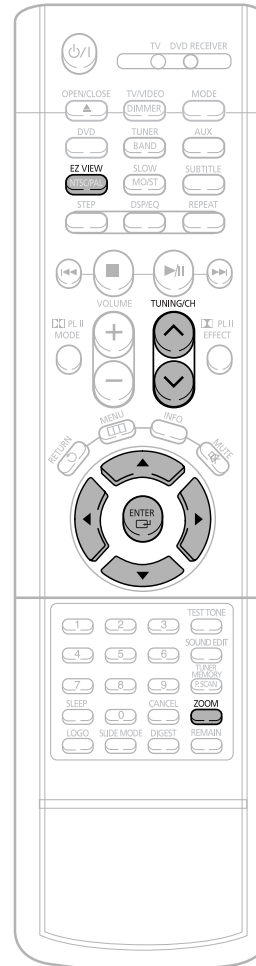

Selecting Audio/Subtitle Language

Audio Language Selection Function DVD

1 Press **INFO** button twice.



2 Press Cursor **▲**, **▼** buttons or numeric buttons to select the desired audio language.

- Depending on the number of languages on a DVD disc, a different audio language (ENGLISH, SPANISH, FRENCH, etc.) is selected each time the button is pressed.

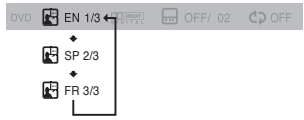

Subtitle Language Selection Function DVD

1 Press **INFO** button twice.



2 Press Cursor **▶** button to move to **SUBTITLE** () display.



3 Press Cursor **▼** button or numeric buttons to select the desired subtitle.

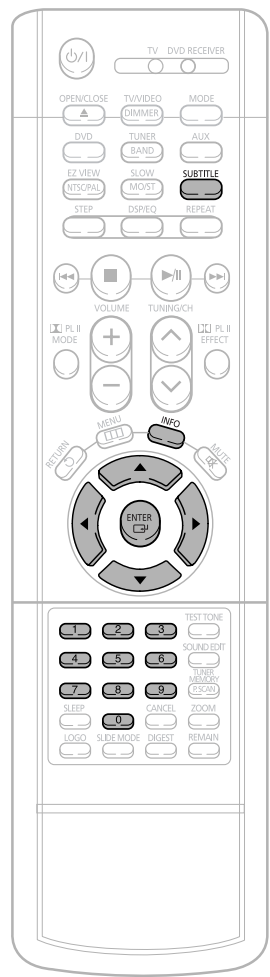
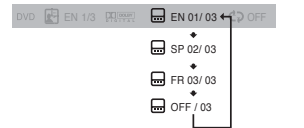

Note

- You can use the SUBTITLE button on the remote control to select a subtitle language.
- Depending on the disc, the Subtitle and Audio Language functions may not work.

Moving Directly to a Scene/Song

DVD VCD CD

1 Press **INFO** button.



Moving to a Title/Track

2 Press Cursor **▲**, **▼** buttons or numeric buttons to select the desired title/track and then press **ENTER** button.



Moving to a Chapter

3 Press Cursor **◀**, **▶** buttons to move to Chapter () display.



Moving to a Chapter

4 Press Cursor **▲**, **▼** buttons or numeric buttons to select the desired chapter and then press **ENTER** button.



Moving to a Specific Time

5 Press Cursor **◀**, **▶** buttons to move to time display.



Moving to a Specific Time

6 Press the numeric buttons to select the desired time and then press **ENTER** button.



MP3 JPEG

Press the **numeric** buttons.

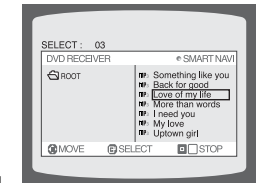

- The selected file will be played.
- An MP3 or JPEG disc cannot be moved from the disc information screen.
- When playing an MP3 or JPEG disc, you cannot use **▲**, **▼** to move a folder. To move a folder, press **■** (Stop) and then press **▲**, **▼**.

Note

- You can press **◀◀◀▶▶▶** on the remote control to move directly to the desired title, chapter, or track.
- Depending on the disc, you may not be able to move to the selected title or time.

Using Disc Menu

You can use the menus for the audio language, subtitle language, profile, etc. DVD menu contents differ from disc to disc.

Using the Title Menu

For DVDs containing multiple titles, you can view the title of each movie. Depending on the disc, this function may either not work at all or may work differently.

DVD

1 In Stop mode, press **MENU** button.

- When playing a VCD (version 2.), this toggles between PBC ON and OFF.



2 Press Cursor **▲**, **▼** buttons to move to 'DISC MENU' and then press **ENTER** button.

- When you select the disc menu that is not supported by the disc, the "This menu is not supported" message appears on the screen.



3 Press Cursor **▲**, **▼**, **◀**, **▶** buttons to select the desired item.



4 Press **ENTER** button.

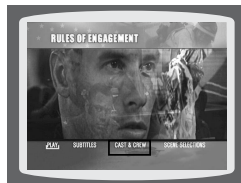

Note

PBC (Playback Control) Function

When playing a VCD (version 2.0), you can select and view various scenes according to the menu screen.

PBC ON: This VCD disc is version 2.0. The disc is played back according to the menu screen. Some functions may be disabled. When some functions are disabled, select "PBC OFF" to enable them.

PBC OFF: This VCD disc is version 1.1. The disc is played back in the same way as with a music CD.

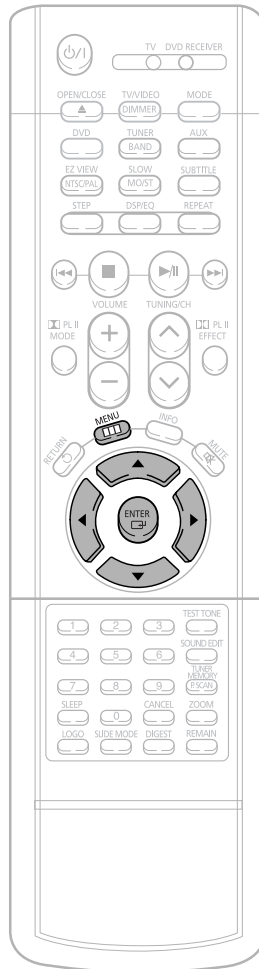

DVD

1 In Stop mode, press **MENU** button.



2 Press Cursor **▲**, **▼** button to move to 'Title Menu'.

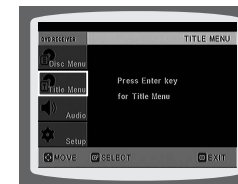

3 Press **ENTER** button.

- The title menu appears.



Press **MENU** button to exit the setup screen.



Setting the Language

OSD language is set to English by default.

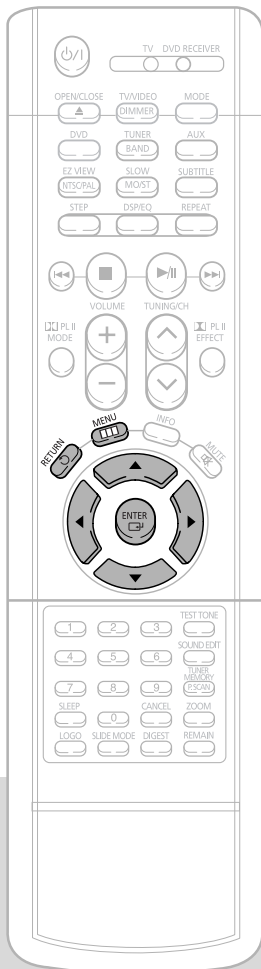

1 In Stop mode, press **MENU** button.



2 Press Cursor **▼** button to move to 'Setup' and then press **ENTER** button.



3 Press **ENTER** button.



4 Press Cursor **▲, ▼** button to select the desired item and then press **ENTER** button.



5 Press Cursor **▲, ▼** button to select the desired language and then press **ENTER** button.



• Once the setup is complete, if the language was set to English, OSD will be displayed in English.

Note

• To select other language, select OTHER and enter the language code of your country. (See 48 page for language code of countries)
AUDIO, SUB TITLE and DISC MENU language can be selected.



Press **RETURN** button to return to the previous level.

Press **MENU** button to exit the setup screen.



Selecting the OSD Language



Selecting the Audio Language (recorded on the disc)



Selecting the Subtitle Language (recorded on the disc)



Selecting the Menu Language (recorded on the disc)

* If the language you selected is not recorded on the disc, menu language will not change even if you set it to your desired language.

SETUP



Setting TV Screen type

Depending on your TV type (Wide Screen TV or conventional 4:3 TV), you can select the TV's aspect ratio.

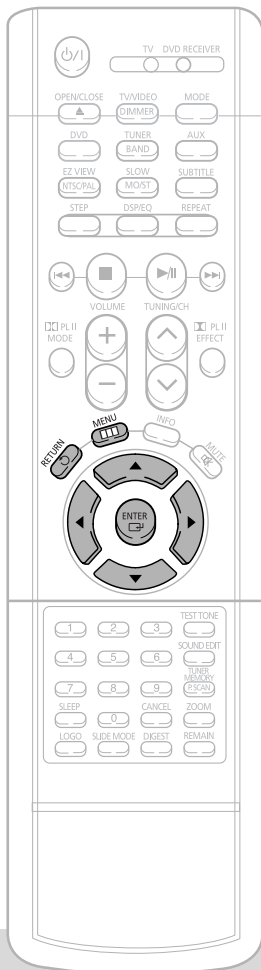

1 In Stop mode, press **MENU** button.



2 Press Cursor \blacktriangledown button to move to 'Setup' and then press **ENTER** button.



3 Press Cursor \blacktriangledown button to move to 'TV DISPLAY' and then press **ENTER** button.



4 Press Cursor \blacktriangle , \blacktriangledown button to select the desired item and then press **ENTER** button.

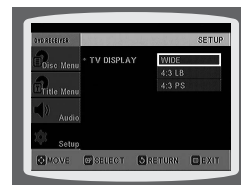

• Once the setup is complete, you will be taken to the previous screen.

Adjusting the TV Aspect Ratio (Screen Size)

The horizontal to vertical screen size ratio of conventional TVs is 4:3, while that of wide screen and high definition TVs is 16:9. This ratio is called the aspect ratio. When playing DVDs recorded in different screen size, you should adjust the aspect ratio to fit your TV or monitor.

★ For a standard TV, select either "4:3LB" or "4:3PS" option according to personal preference. Select "16:9" if you have a wide screen TV.

WIDE

: Select this to view a 16:9 picture in the full-screen mode on your wide screen TV.
• You can enjoy the wide screen aspect.



4:3LB (4:3 Letterbox)

: Select this to play a 16:9 picture in the letter box mode on a conventional TV.
• Black bars will appear at the top and bottom of the screen.



4:3PS (4:3 Pan&Scan)

: Select this to play a 16:9 picture in the pan & scan mode on a conventional TV.
• You can see the central portion of the screen only (with the sides of the 16:9 picture cut off).



Note

- If a DVD is in the 4:3 ratio, you cannot view it in wide screen.
- Since DVD discs are recorded in various image formats, they will look different depending on the software, the type of TV, and the TV aspect ratio setting.

Press **RETURN** button to return to the previous level.

Press **MENU** button to exit the setup screen.

Setting Parental Controls (Rating Level)

Use this to restrict playback of adult or violent DVDs you do not want children to view.

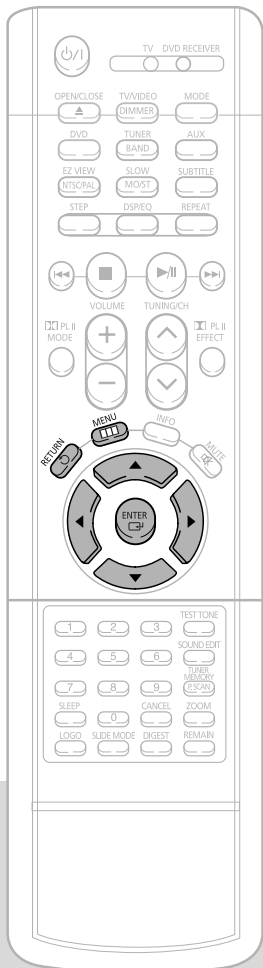

1 In Stop mode, press **MENU** button.



2 Press Cursor **▼** button to move to 'Setup' and then press **ENTER** button.



3 Press Cursor **▼** button to move to 'PARENTAL' and then press **ENTER** button.

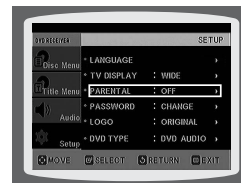

4 Press Cursor **▲, ▼** button to select the desired rating level and then press **ENTER** button.

- If you have selected Level 6, you cannot view DVDs with Level 7 or higher.
- The higher the level, the closer the content is to violent or adult material.



5 Enter the password and then press **ENTER** button.

- The password is set to "7890" by default.
- Once the setup is complete, you will be taken to the previous screen.

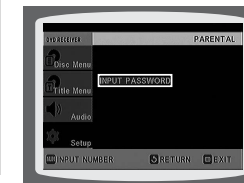

Note • This function works only if a DVD disc contains the rating level information.

Press **RETURN** button to return to the previous level.

Press **MENU** button to exit the setup screen.

Setting the Password

You can set the password for the Parental (rating level) setting.

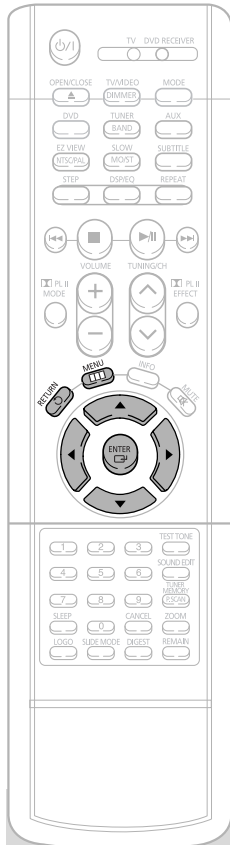

1 Press **MENU** button.



2 Press **Cursor** button to move to 'Setup' and then press **ENTER** button.



3 Press **Cursor** button to move to 'PASSWORD' and then press **ENTER** button.



4 Press **ENTER** button.

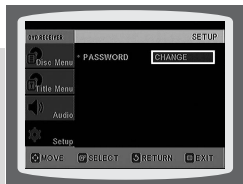

5 Enter the password and then press **ENTER** button.



- Enter the old password, a new password, and confirm new password.
- The setting is complete.

Press **RETURN** button to return to the previous level.

Press **MENU** button to exit the setup screen.

Language Code List

Enter the appropriate code number for the initial settings "Disc Audio", "Disc Subtitle" and/or "Disc Menu" (See page 41).

Code	Language	Code	Language	Code	Language	Code	Language
1027	Afar	1181	Frisian	1334	Latvian, Lettish	1506	Slovenian
1028	Abkhazian	1183	Irish	1345	Malagasy	1507	Samoan
1032	Afrikaans	1186	Scots Gaelic	1347	Maori	1508	Shona
1039	Amharic	1194	Galician	1349	Macedonian	1509	Somali
1044	Arabic	1196	Guarani	1350	Malayalam	1511	Albanian
1045	Assamese	1203	Gujarati	1352	Mongolian	1512	Serbian
1051	Aymara	1209	Hausa	1353	Moldavian	1513	Siswati
1052	Azerbaijani	1217	Hindi	1356	Marathi	1514	Sesotho
1053	Bashkir	1226	Croatian	1357	Malay	1515	Sundanese
1057	Byelorussian	1229	Hungarian	1358	Maltese	1516	Swedish
1059	Bulgarian	1233	Armenian	1363	Burmese	1517	Swahili
1060	Bihari	1235	Interlingua	1365	Nauru	1521	Tamil
1069	Bislama	1239	Interlingue	1369	Nepali	1525	Tegulu
1066	Bengali, Bangla	1245	Inupiak	1376	Dutch	1527	Tajik
1067	Tibetan	1248	Indonesian	1379	Norwegian	1528	Thai
1070	Breton	1253	Icelandic	1393	Occitan	1529	Tigrinya
1079	Catalan	1254	Italian	1403	(Afan) Oromo	1531	Turkmen
1093	Corsican	1257	Hebrew	1408	Oriya	1532	Tagalog
1097	Czech	1261	Japanese	1417	Punjabi	1534	Setswana
1103	Welsh	1269	Yiddish	1428	Polish	1535	Tonga
1105	Danish	1283	Javanese	1435	Pashto, Pushto	1538	Turkish
1109	German	1287	Georgian	1436	Portuguese	1539	Tsonga
1130	Bhutani	1297	Kazakh	1463	Quechua	1540	Tatar
1142	Greek	1298	Greenlandic	1481	Rhaeto-Romance	1543	Twi
1144	English	1299	Cambodian	1482	Kirundi	1557	Ukrainian
1145	Esperanto	1300	Kannada	1483	Romanian	1564	Urdu
1149	Spanish	1301	Korean	1489	Russian	1572	Uzbek
1150	Estonian	1305	Kashmiri	1491	Kinyarwanda	1581	Vietnamese
1151	Basque	1307	Kurdish	1495	Sanskrit	1587	Volapuk
1157	Persian	1311	Kirghiz	1498	Sindhi	1613	Wolof
1165	Finnish	1313	Latin	1501	Sangro	1632	Xhosa
1166	Fiji	1326	Lingala	1502	Serbo-Croatian	1665	Yoruba
1171	Faeroese	1327	Laothian	1503	Singhalese	1684	Chinese
1174	French	1332	Lithuanian	1505	Slovak	1697	Zulu

Note

The password is set to "7890" by default.



Setting the Wallpaper

JPEG DVD VCD

While watching a DVD, VCD or JPEG CD, you can set the image you like as background wallpaper.

Setting the Wallpaper

1 During playback, press **PLAY/PAUSE** button when the image you like comes up.

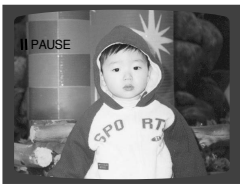

2 Press **LOGO** button.

• "COPY LOGO DATA" will be displayed on the TV screen.

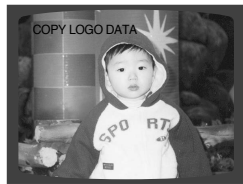

3 The power will turn off and then back on and the disc tray will open automatically.

• The selected wallpaper will be displayed.

4 Press **OPEN/CLOSE** to close the disc tray.

• You can repeat Steps 1 and 2 to set up to 3 wallpapers.

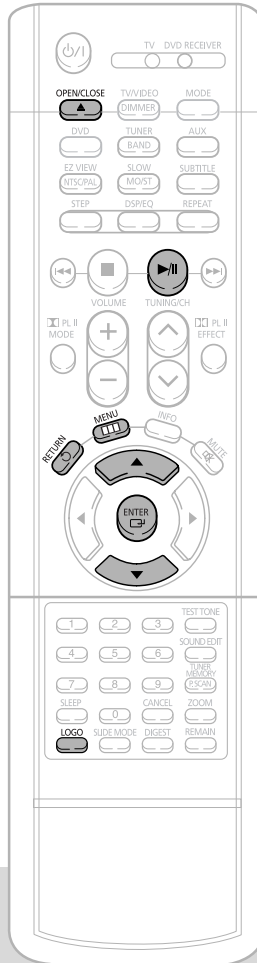

To Change the Wallpaper

1 In Stop mode, press **MENU** button.



2 Press **Cursor** button to move to 'Setup' and then press **ENTER** button.



3 Press **Cursor** button to move to 'LOGO' and then press **ENTER** button.



4 Press **Cursor** to select the desired 'USER', and then press **ENTER**.



5 Press **MENU** button to exit the setup screen.

Press **RETURN** button to return to the previous level.

Press **MENU** button to exit the setup screen.



Select this to set the Samsung Logo image as your wallpaper.



Select this to set the desired image as your wallpaper.

DVD Playback Mode

Some DVD-Audio discs contain DVD-Video as well as DVD-Audio.
To play back the DVD-Video portion of the DVD-Audio disc, set the unit to DVD-Video mode.

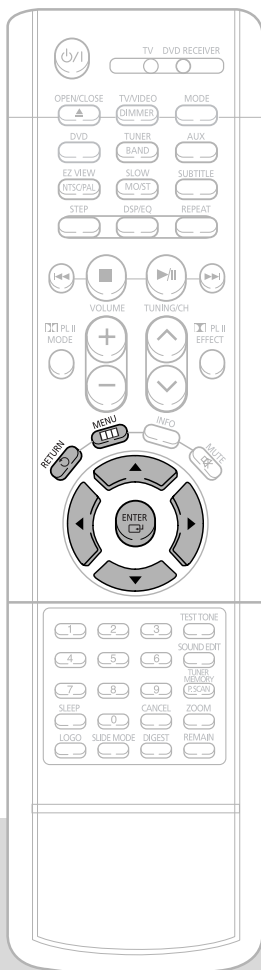

1 Press the **MENU** button while the disc tray is open.



3 Press Cursor **▼** button to move to 'DVD TYPE' and then press **ENTER** button.



2 Press Cursor **▼** button to move to 'Setup' and then press **ENTER** button.



4 Press Cursor **▲, ▼** button to move to 'DVD VIDEO' and then press **ENTER** button.

• Set steps 1 ~ 4 again if you want to switch to DVD AUDIO Play mode.



When Selecting DVD Play Mode:

- **DVD VIDEO** : set to play the DVD video contents contained in DVD audio disc.
- **DVD AUDIO** : set to play the default DVD audio.

AV SYNC Setup

Video may look slower than the audio if it is connected with digital TV.
In this case, adjust the delay time of audio to optimal status to fit the video.

1 Press the **MENU** button.

• Setup menu appears.



3 Press Cursor **▲, ▼** buttons to move to 'AV-SYNC' and then press **ENTER** button.

• AV-SYNC screen appears.

2 Press Cursor **→, ←** buttons to move to 'Audio' and then press **ENTER** button.

• 'Audio' menu appears.

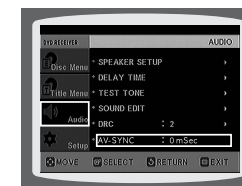

4 Press Cursor **→, ←** buttons to select the Delay Time of AV-SYNC and then press the **ENTER** button.

• You can set the audio delay time between 0 ms and 300 ms. Set it to the optimal status.



Note

- DVD Play mode is set to DVD Audio as factory default setting.

Press **RETURN** button to return to the previous level.

Press **MENU** button to exit the setup screen.

Press **RETURN** button to return to the previous level.

Press **MENU** button to exit the setup screen.

Setting the Speaker Mode

Signal outputs and frequency responses from the speakers will automatically be adjusted according to your speaker configuration and whether certain speakers are used or not.

1 In Stop mode, press **MENU** button.



2 Press Cursor \blacktriangledown button to move to 'Audio' and then press **ENTER** button.



3 In the Speaker Setup, press the **ENTER** button again.



4 Press Cursor \blacktriangle , \blacktriangledown , \blacktriangleleft , \blacktriangleright buttons to move to the desired speaker and then press **ENTER** button.

- For C, LS, and RS, each time the button is pressed, the mode switches alternately as follows: SMALL \rightarrow NONE.
- For L and R, the mode is set to SMALL.



SMALL : Select this when using the speakers.
NONE : Select this when no speakers are installed.

Note

- Depending on PRO LOGIC and STEREO, the speaker mode may vary.

Setting the Test Tone

Press the Test Tone to check the speaker connections and to adjust the speaker levels.

1 In Stop mode, press **MENU** button.



2 Press Cursor \blacktriangledown button to move to 'Audio' and then press **ENTER** button.



3 Press Cursor \blacktriangledown button to move to 'TEST TONE' and then press **ENTER** button.

- The test tone will be sent to L \rightarrow C \rightarrow R \rightarrow RS \rightarrow LS \rightarrow SW in that order. If the **ENTER** button is pressed again at this time, the test tone will stop.



Press **RETURN** button to return to the previous level.

Press **MENU** button to exit the setup screen.

When manually testing using the TEST TONE button

Press **TEST TONE** button.

- Test tone will be produced as follows: When playing a DVD or CD, this will work only in Stop mode.
- Use this function to check that each speaker is correctly connected and that there is no problem.

To end the test tone, press **TEST TONE** button.

Multi-Channel Pro Logic Mode

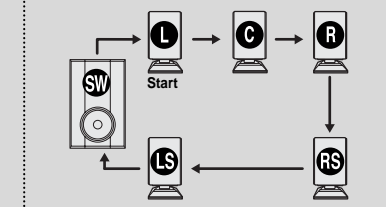



Setting the Delay Time

If the speakers cannot be placed at equal distances from the listening position, you can adjust the delay time of the audio signals from the center and rear speakers.

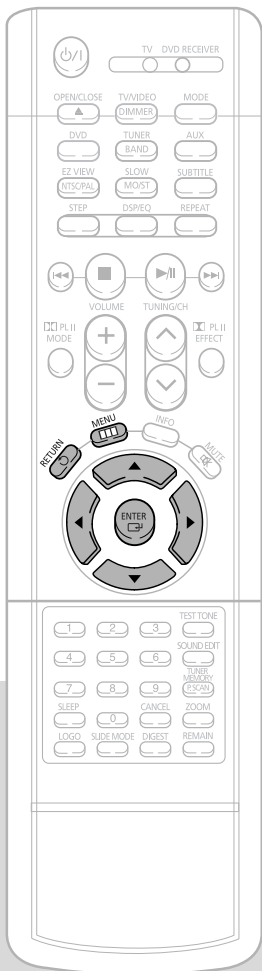

1 In Stop mode, press **MENU** button.



2 Press Cursor ∇ button to move to 'Audio' and then press **ENTER** button.



3 Press Cursor ∇ button to move to 'DELAY TIME' and then press **ENTER** button.

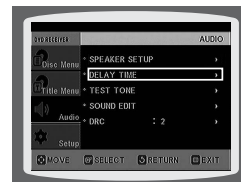

4 Press Cursor $\uparrow, \downarrow, \leftarrow, \rightarrow$ buttons to move to the desired speaker and then press **ENTER** button.



5 Press Cursor \leftarrow, \rightarrow to set the Delay time.

- You can set the delay time for C between 00 and 05mSEC and for LS and RS between 00 and 15mSEC.



Setting up the Speaker Delay Time

When 5.1CH Surround Sound is played, you can enjoy the best sound if the distance between you and each speaker is the same. Since the sounds arrive at the listening position at different times depending on the placement of speakers, you can adjust this difference by adding a delay effect to the sound of the Center Speaker and Surround Speakers.

Note

- With \square PL (Dolby Pro Logic II), the delay time may be different for each mode.
- With AC-3 and DTS, the delay time can be set between 00 and 15mSEC.

Setting CENTER SPEAKER

If the distance of Dc is equal to or longer than the distance of Df in the figure, set the mode as 0ms. Otherwise, change the setting according to the table.

Distance between Df and Dc	Delay Time
0.00 m	0 ms
0.34 m	1 ms
0.68 m	2 ms
1.02 m	3 ms
1.36 m	4 ms
1.70 m	5 ms

Setting REAR (SURROUND) SPEAKERS

If the distance of Df is equal to the distance of Ds in the figure, set the mode as 0ms. Otherwise, change the setting according to the table.

Distance between Df and Ds	Delay Time
0.00 m	0 ms
1.02 m	3 ms
2.04 m	6 ms
3.06 m	9 ms
4.08 m	12 ms
5.10 m	15 ms

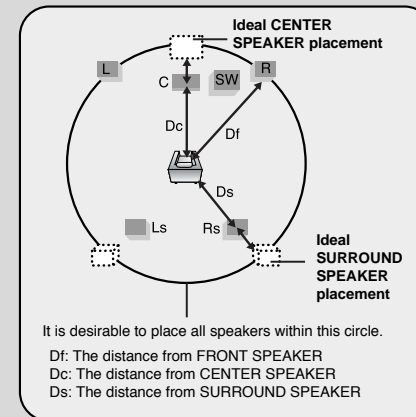



Setting the Audio Quality

You can adjust the balance and level for each speaker.

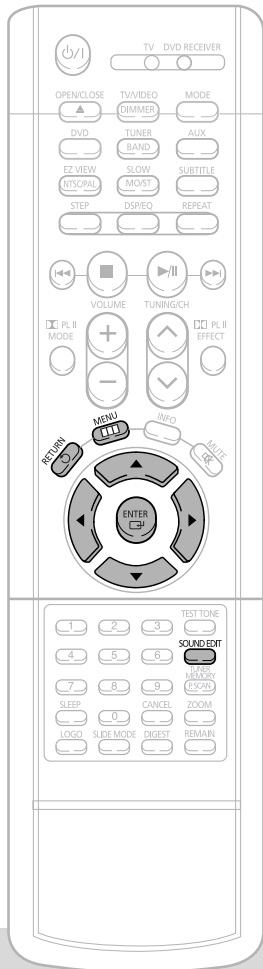

Method 1 When adjusting the audio quality using the setup screen

1 In Stop mode, press **MENU** button.



2 Press Cursor **▼** button to move to 'Audio' and then press **ENTER** button.



3 Press Cursor **▼** button to move to 'SOUND EDIT' and then press **ENTER** button.

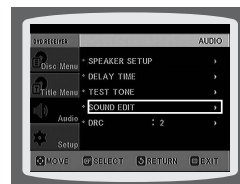

4 Press Cursor **▲, ▼, ◀, ▶** buttons to select the desired item and then press **ENTER** button.



Method 2 When manually adjusting with the SOUND EDIT button

Adjusting Front Speaker Balance

1 Press **SOUND EDIT** button and then press Cursor **◀, ▶**.



Adjusting Rear Speaker Balance

2 Press **SOUND EDIT** button and then press Cursor **◀, ▶**.



Adjusting Center Speaker Level

3 Press **SOUND EDIT** button and then press Cursor **◀, ▶**.



Adjusting Rear Speaker Level

4 Press **SOUND EDIT** button and then press Cursor **◀, ▶**.



Adjusting Subwoofer Speaker Level

5 Press **SOUND EDIT** button and then press Cursor **◀, ▶**.



Press **RETURN** button to return to the previous level.

Press **MENU** button to exit the setup screen.

Note

Adjusting Front/Rear Speaker Balance

- You can select between 00 and -06 and OFF.
- The volume decreases as you move closer to -6.

Adjusting Center/Rear/Subwoofer Speaker Level

- The volume level can be adjusted in steps from +6dB to -6dB.
- The sound gets louder as you move closer to +6dB and quieter as you get closer to -6dB.

Setting the DRC (Dynamic Range Compression)

You can use this function to enjoy Dolby Digital sound when watching movies at low volume at night.

- 1 In Stop mode, press **MENU** button.



- 2 Press Cursor **▼** button to move to 'Audio' and then press **ENTER** button.



- 3 Press Cursor **▼** button to move to 'DRC' and then press **ENTER** button.



- 4 Press Cursor **▲, ▼** to adjust the 'DRC'.

- The Cursor **▲** button is pressed, the greater the effect, and the Cursor **▼** button is pressed, the smaller the effect.



Press **RETURN** button to return to the previous level.

Press **MENU** button to exit the setup screen.

Sound Field (DSP)/EQ Function

DSP(Digital Signal Processor) DSP modes have been designed to simulate different acoustic environments. EQ: You can select from ROCK, POP, or CLASSIC, depending on the genre of music.

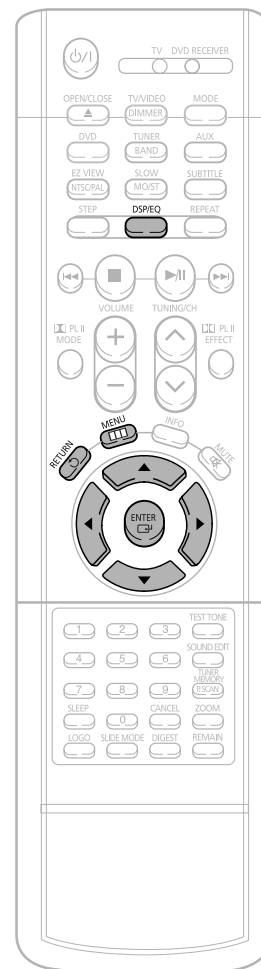

Press **DSP/EQ** button.

- "DSP" appears on the display panel.
- Each time the button is pressed, the selection changes as follows:

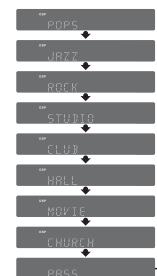

Note

- This feature works with CDs, MP3-CDs and 2 channel DVD-Audio and Dolby Digital discs.
- When playing a DVD disc encoded with two or more channels, multi-channel mode will be selected automatically and DSP/EQ function does not work.

Note

- POP, JAZZ, ROCK:** Depending on the genre of music, you can select from POP, JAZZ, and ROCK.
- STUDIO :** Provides a sense of presence as if in a studio.
- CLUB :** Simulates the sound of a dance club with a throbbing bass beat.
- HALL :** Provides a clear vocal as if listening in a concert hall.
- MOVIE:** Provides the feeling of a movie theater.
- CHURCH:** Gives the feel of being in a grand church.
- PASS:** Select this for normal listening.

Dolby Pro Logic II Mode

You can select the desired Dolby Pro Logic II audio mode.

Press **PL II MODE** button.

- Each time the button is pressed, the mode changes as follows.

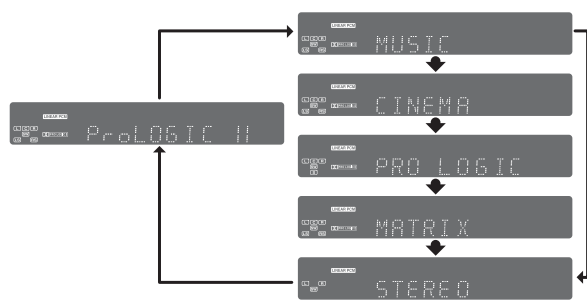

Note

- When selecting Pro Logic II mode, connect your external device to the AUDIO INPUT jacks (L and R) on the player. If you connect to only one of the inputs (L or R), you cannot listen to 5.1 channel surround sound.

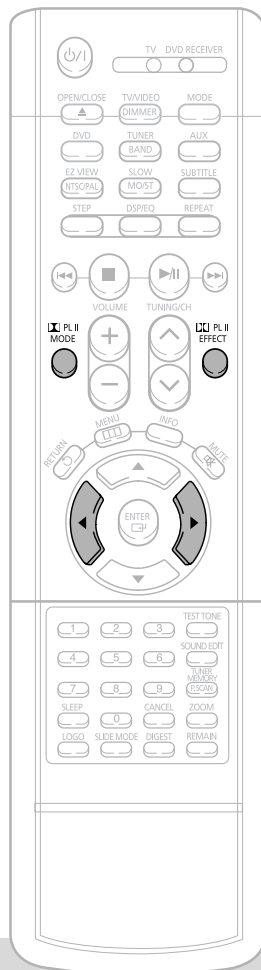

PRO LOGIC II

- **MUSIC:** When listening to music, you can experience sound effects as if you are listening to the actual performance.
- **CINEMA:** Adds realism to the movie soundtrack.
- **PRO LOGIC:** You will experience a realistic multi-channel effect, as if using five speakers, while using just the front left and right speakers.
- **MATRIX:** You will hear 5.1 channel surround sound.

STEREO: Select this to listen to sounds from the front left and right speakers and the subwoofer only.

Dolby Pro Logic II Effect

This function works only in Dolby Pro Logic MUSIC mode.

1 Press **PL II MODE** button to select 'MUSIC' mode.



2 Press **PL II EFFECT** button and then press Cursor **◀, ▶** buttons to select the mode.

- You can select either 0 or 1.



3 Press **PL II EFFECT** button and then press Cursor **◀, ▶** buttons to select the mode.

- You can select between 0 and 7.



4 Press **PL II EFFECT** button and then press Cursor **◀, ▶** buttons to select the mode.

- You can select between 0 and 6.



Note

- When playing a DVD disc encoded with two or more channels, multi-channel mode will be selected automatically and **PL II** (Dolby Pro Logic II) button does not work.

- **PANORAMA:** This mode extends the front stereo image to include the surround speakers for an exciting "wraparound" effect with side wall imaging.
- **CENTER WIDTH:** Sound is output to the center speaker only. The front left and right speakers produce phantom sound.
- **DIMENSION:** Incrementally adjusts the sound field (DSP) from the front or rear.



Listening to Radio

You can listen to the chosen band (FM, AM broadcast stations) by using either the automatic or manual tuning operation.



Presetting Stations

You can store up to:

- ◆ 15 FM stations
- ◆ 15 AM stations

- FM Frequency Modulation
- AM Medium Wave

Remote Control Unit

1 Press **TUNER/BAND** button.

- The selection toggles back and forth between "FM → AM" each time the **TUNER(BAND)** button is pressed.

2 Tune in to the desired station.

Automatic Tuning 1 When **◀▶▶▶▶** is pressed, a preset broadcast station is selected.

Automatic Tuning 2 Press and hold **⏪⏩** to automatically search for active broadcasting stations.

Manual Tuning Briefly press **⏪⏩** to increase or decrease the frequency incrementally.

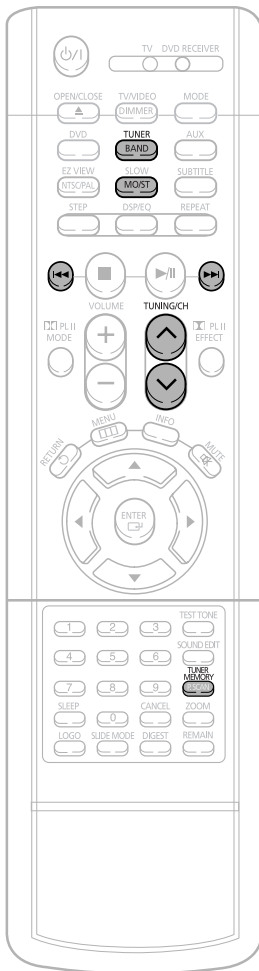

Main Unit

1 Press the **Function** button to select the desired band (FM, AM).

2 Select a broadcast station.

Automatic Tuning 1 Press the **STOP** button to select PRESET and then press **◀▶▶▶▶** button to select the preset station.

Automatic Tuning 2 Press the **STOP** button to select "MANUAL" and then press and hold **◀▶▶▶▶** button to automatically search the band.

Manual Tuning Press **STOP** to select MANUAL and then briefly press **◀▶▶▶▶** to tune in to a lower or higher frequency.

Example: Presetting FM 89.1 in the memory

1 Press the **TUNER(BAND)** button and select the FM band.

- Each time the button is pressed, the band switches between "FM → AM".



2 Press **⏪⏩** to select "89.10".

- Refer to Step 2 on page 63 to automatically or manually tune in to a station.



3 Press the **TUNER MEMORY** button.

- "PRGM" flashes in the display. Tune in to a station.



4 Press **◀▶▶▶▶** to select preset number.

- You can select between 1 and 15.



5 Press the **TUNER MEMORY** button again.

- Press the **TUNER MEMORY** button before "PRGM" disappears from the display.
- "PRGM" disappears from the display and the station is stored in memory.



6 To preset another station, repeat steps 2 to 5.

RADIO OPERATION

Press **MO/ST** button to listen in Mono/Stereo. (This applies only when listening to an FM station.)

- Each time the button is pressed, the sound switches between "STEREO" and "MONO".
- In a poor reception area, select MONO for a clear, interference-free broadcast.

To tune in to a preset station, press **◀▶▶▶▶** on the remote control to select a channel.

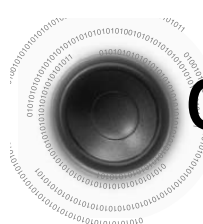

Convenient Functions

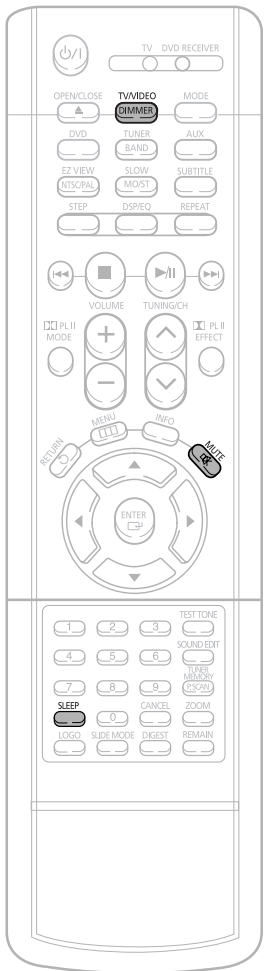

Sleep Timer Function

You can set the time that the DVD player will shut itself off.

Press **SLEEP** button.

- "SLEEP" will be displayed. Each time the button is pressed the preset time changes as follows: 10 → 20 → 30 → 60 → 90 → 120 → 150 → OFF.



To confirm the sleep timer setting, press **SLEEP** button.

- The remaining time before the DVD player will shut itself off is displayed.
- Pressing the button again changes the sleep time from what you have set earlier.

To cancel the sleep timer, press **SLEEP** button until OFF appears on the display.

Adjusting Display Brightness

You can adjust the brightness of the display on the main unit so it won't interfere with your movie viewing.

Press **DIMMER** button.

- Each time the button is press, the brightness changes as follows: SLIGHTLY DARK → DARK → BRIGHT.

Mute Function

This is useful when answering a doorbell or telephone call.

Press **MUTE** button.

- 'MUTE' flash in the display.
- To switch the sound back on (at the same volume as before), press **MUTE** again or the **VOLUME** buttons.



Using Headphones

Use headphones (not supplied) for private listening pleasure.

Connect the headphones to the PHONES jack for private listening.

Caution

- To prevent hearing damage, do not increase the volume excessively when using headphones.

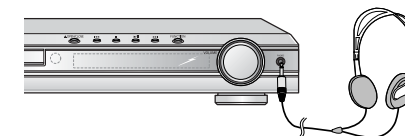



Operating a TV with the Remote Control

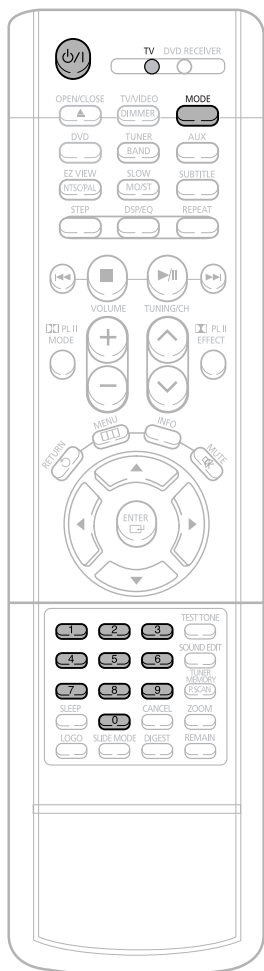

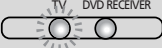
- When operating a TV with the remote control**
- 1** Press the **MODE** button to make the TV indicator on the remote control flash.
 
 - 2** Press **POWER** button to turn on the TV.
 - 3** Point the remote control toward the TV.
 - 4** While holding down **POWER**, enter the code corresponding to your brand of TV.
 - If the code matches the TV's code, the TV will be turned off.
 - If there is more than one code listed for your TV in the table, enter one at a time to determine which code works.

Example: For a Samsung TV
While holding down **POWER**, use the number buttons to enter 00, 01, 02, 03, 04, and 05.
 - 5** Point the remote control toward the TV and press **POWER**. If the TV turns off or on, the setting is complete.
 - You can use the TV POWER, VOLUME, CHANNEL, and Numeric buttons (0~9).

Note

- The remote control may not work on some brands of TVs. Also some operations may not be possible depending on your brand of TV.
- If you do not set the remote control with the code for your brand of TV, the remote control will work on a Samsung TV by default.

TV Brand Code List

No.	Brand	Code	No.	Brand	Code
1	SAMSUNG	00(Initial Value), 01, 02, 03, 04, 05, 73	30	BRANDT	41
2	ANAM	06~11, 59	31	FERGUSON	41
3	DAEWOO	12~18, 20, 21	32	PIONEER	41, 48, 74
4	LG	05, 20, 21, 22, 53	33	TELEAVA	41
5	HITACHI	23, 40, 41, 49	34	FINLUX	05, 42, 47
6	JVC	24, 55	35	FISHER	31
7	SHARP	27, 33, 34, 35, 54	36	AKAI	31
8	SONY	27, 36	37	YOKO	05
9	TOSHIBA	27, 37, 42, 43, 44, 46	38	PHONOLA	05, 45, 47
10	SANYO	27, 30, 31, 32	39	RADIOLA	05, 45
11	MITSUBISHI	05, 27, 28	40	SCHNEIDER	05
12	MATSUSHITA	09, 26	41	NEWSAN	58
13	TELEFUNKEN	41, 49, 51, 57	42	CONTINENTAL EDISON	49
14	RCA	29, 61	43	SALORA	48
15	PANASONIC	07, 09, 26, 48, 49, 50	44	SELECO	48
16	SABA	40, 41, 47, 48, 49	45	NOKIA	48
17	PHILIPS	05, 45, 47, 64, 65, 66, 67, 68, 69	46	REX	48
18	GRUNDIG	39, 42, 46, 70, 71, 72	47	MIVAR	46
19	ZENITH	38	48	IMPERIAL	46
20	MIVAL	52	49	CGE	46
21	NOBLEX	56	50	BANG & OLUFSEN	47
22	EMERSON	19	51	BRIONVEGA	47
23	MAGNAVOX	25	52	FORMENTI	47
24	LOEWE	05, 60	53	METZ	47
25	THOMSON	40, 41, 49, 62, 63	54	WEGA	47
26	NORDMENDE	40, 41, 49	55	RADIOMARELLI	47
27	LOEWE OPTA	36, 47, 05	56	SINGER	47
28	BLAUPUNKT	39	57	SINUDYNE	47
29	SIEMENS	39			

MISCELLANEOUS



Before Calling for Service

Refer to the chart below when this unit does not function properly. If the problem you are experiencing is not listed below or if the instruction below does not help, turn off the unit, disconnect the power cord, and contact the nearest authorized dealer or Samsung Electronics Service Center.

Symptom	Check/Remedy
Disc tray does not open.	<ul style="list-style-type: none"> • Is the power cord plugged securely into the outlet? • Turn off the power and then turn it back on.
Playback does not start.	<ul style="list-style-type: none"> • Check the region number of the DVD. DVD discs purchased from abroad may not be playable. • CD-ROMs and DVD-ROMs cannot be played on this DVD player. • Make sure that the rating level is correct.
Playback does not start immediately when the Play/Pause button is	<ul style="list-style-type: none"> • Are you using a deformed disc or a disc with scratches on the surface? • Wipe the disc clean.
Sound is not produced.	<ul style="list-style-type: none"> • No sound is heard during fast playback, slow playback, and step motion playback. • Are the speakers connected properly? Is the speaker setup correctly customized? • Is the disc severely damaged?
Sound can be heard only from a few speakers and not all six.	<ul style="list-style-type: none"> • When listening to a CD or radio, sound is output to the front speakers (L/R) only. Select "PRO LOGIC II" by pressing PL II (Dolby Pro Logic II) on the remote control to use all six speakers. • Make sure that the DVD disc is 5.1-CH compatible. • If you set C, SL, and SR to NONE in the speaker mode in the audio setup of the setup screen, no sound is heard from the center speaker and the front left and right speakers. Set C, SL, and SR to SMALL.
Picture does not appear, sound is not produced, or the disc tray opens 2 to 5 seconds later.	<ul style="list-style-type: none"> • Was the DVD player suddenly moved from a cold place to a warm one? When condensation forms inside the player, remove the disc and let the player stand for 1 or 2 hours with the power on. (You can use the player again after condensation disappears.)
Dolby Digital 5.1 CH Surround Sound is not produced.	<ul style="list-style-type: none"> • Is there "Dolby Digital 5.1 CH" mark on the disc? Dolby Digital 5.1 CH Surround Sound is produced only if the disc is recorded with 5.1 channel sound. • Is the audio language correctly set to DOLBY DIGITAL 5.1-CH in the information display?

Symptom	Check/Remedy
<ul style="list-style-type: none"> • Disc is rotating but no picture is produced. • Picture quality is poor and picture is shaking. 	<ul style="list-style-type: none"> • Is the TV power on? • Are the video cables connected properly? • Is the disc dirty or damaged? • A poorly manufactured disc may not be playable.
The remote control does not work.	<ul style="list-style-type: none"> • Is the remote control being operated within its operation range of angle and distance? • Are the batteries exhausted? • Have you select the mode(TV/DVD) functions of the remote control (TV or DVD) correctly?
Audio language and subtitles do not work.	<ul style="list-style-type: none"> • Audio language and subtitles will not work for DVDs not containing them. And depending on the disc, they may work differently.
Menu screen does not appear even when the menu function is selected.	<ul style="list-style-type: none"> • Are you using a disc that does not contain menus?
Aspect ratio cannot be changed.	<ul style="list-style-type: none"> • You can play 16:9 DVDs in 16:9 WIDE mode, 4:3 LETTER BOX mode, or 4:3 PAN SCAN mode, but 4:3 DVDs can be seen in 4:3 ratio only. Refer to the DVD disc jacket and then select the appropriate function.
Can't receive radio broadcast.	<ul style="list-style-type: none"> • Is the antenna connected properly? • If the antenna's input signal is weak, install an external FM antenna in an area with good reception.
<ul style="list-style-type: none"> • The main unit is not working. (Example: The power goes out or strange noise is heard.) • The DVD player is not working normally. 	<ul style="list-style-type: none"> • Turn off the power and hold the button on the main unit for longer than 5 seconds. <p>Using the RESET function will erase all stored settings. Do not use this unless necessary.</p>
The password for rating level has been forgotten.	<ul style="list-style-type: none"> • While "NO DISC" message appears on the display of main unit, hold the main unit's button for longer than 5 seconds. "INITIALIZE" appears on the display and all settings will return to the default values. • Press the POWER button. <p>Using the RESET function will erase all stored settings. Do not use this unless necessary.</p>

MISCELLANEOUS

Cautions on Handling and Storing Discs

Small scratches on the disc may reduce sound and picture quality or cause skipping. Be especially careful not to scratch discs when handling them.

● Handling discs

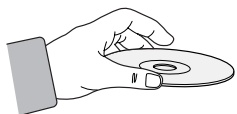

Do not touch the playback side of the disc. Hold the disc by the edges so that fingerprints will not get on the surface.
Do not stick paper or tape on the disc.

● Disc Storage

Do not keep in direct sunlight

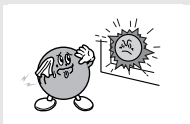

Keep in a cool ventilated area

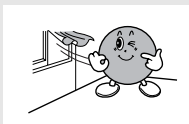

Keep in a clean Protection jacket. Store vertically.

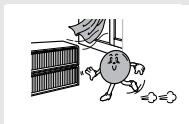

Caution

- Do not allow the discs to become contaminated with dirt.
- Do not load cracked or scratched discs.

● Handling and Storing Discs



When you get fingerprints or dirt on the disc, clean it with a mild detergent diluted in water and wipe with a soft cloth.

- When cleaning, wipe gently from the inside to the outside of the disc.

Note

- Condensation may form if warm air comes into contact with cold parts inside the player. When condensation forms inside the player, the player may not operate correctly. If this occurs, remove the disc and let the player stand for 1 or 2 hours with the power on.

Specifications

GENERAL	Power Consumption	90W	
	Weight	4Kg	
	Dimensions (W x H x D)	360 x 65 x 394 mm	
	Operating Temperature Range	+5°C~+35°C	
	Operating Humidity Range	10%~75%	
FM TUNE	Usable Sensitivity	10dB	
	S/N Ratio	55dB	
	Distortion	0.8%	
AM TUNE	Usable Sensitivity	60dB	
	S/N Ratio	35dB	
	Distortion	2%	
VIDEO OUTPUT	Composite Video	1.0Vp-p(75Ω load)	
	S-Video	Luminance signal	1.0Vp-p(75Ω load)
		Color Signal	0.286Vp-p(75Ω load)
	Component Video	Y	1.0Vp-p(75Ω load)
Pr		0.70Vp-p(75Ω load)	
Pb		0.70Vp-p(75Ω load)	
AMPLIFIER	Front speaker output	60W x 2(4Ω)	
	Center speaker output	60W(4Ω)	
	Rear speaker output	60W x 2(4Ω)	
	Subwoofer speaker output	100W(4Ω)	
	Frequency range	20Hz~20kHz	
	S/N Ratio	70dB	
	Channel separation	60dB	
Input sensitivity	(AUX)400mV		
SPEAKER	Speaker system	5.1ch speaker system	
		Front/Center/Rear speaker	Subwoofer speaker
	Impedance	4Ω x 5	4Ω
	Frequency range	150Hz~20kHz	30Hz~150Hz
	Output sound pressure level	85dB/W/M	86dB/W/M
	Rated input	60W	100W
	Maximum input	120W	200W
	Dimensions (W x H x D)	85 x 131 x 93.2 mm	180 x 409 x 380 mm
Weights	0.7 Kg	7.0 Kg	







Notes on Terminology

HT-DS420 / DS403T

S P E A K E R	Speaker system	5.1ch speaker system					
		Front/Center/Rear speaker			Subwoofer speaker		
	Impedance	4 Ω x 5			4 Ω		
	Frequency range	150 Hz~20 KHz			30Hz~150 Hz		
	Output sound pressure level	85 dB/W/M			86 dB/W/M		
	Rated input	DS420	Front	Center/Rear	DS403T	100 W	100W
	Maximum input		100 W	60 W		200 W	200W
	Dimensions (W x H x D)	DS420	Front	85 x 1150 x 99 mm			180 x 409x 380 mm
			Center/Rear	85 x 131x 93.2mm			
		DS403T	Front/Rear	85 x 1150 x 99 mm			
Center			325 x 85 x 99 mm				
Weights	DS420	Front	4.4 Kg			7.0 Kg	
		Center/Rear	0.7Kg				
	DS403T	Front/Rear	4.4 Kg				
		Center	1.6 Kg				

HT-DS420S

S P E A K E R	Speaker system	5.1ch speaker system				
		Front/Center/Rear speaker			Subwoofer speaker	
	Impedance	4 Ω x 5			4 Ω	
	Frequency range	150 Hz~20 KHz			30Hz~150 Hz	
	Output sound pressure level	85 dB/W/M			86 dB/W/M	
	Rated input	60 W			100W	
	Maximum input	120 W			200W	
	Dimensions (W x H x D)	Front	85 x 1150 x 99 mm			200 x 403x 441 mm
		Rear	85 x 131x 93.2 mm			
		Center	325 x 85 x 99 mm			
Weights	Front	4.4 Kg			7.8 Kg	
	Rear	0.7 Kg				
	Center	1.6 Kg				

ANGLE	Recorded onto some DVD discs are scenes which have been simultaneously shot from a number of different angles (the same scene is shot from the front, from the left, from the right, etc.). With such discs, the Angle button can be used to change the angle of view for specific scenes.
CHAPTER NUMBER	These numbers are recorded on DVD discs. A Title is subdivided into many sections, each of which is numbered, and specific parts of the video can be searched quickly using these numbers.
DVD	A high-density optical disc on which high-quality pictures and sound have been recorded by means of digital signals. Incorporating a new video compression technology (MPEG-2) and high-density recording technology, a DVD disc comprises two 0.6 mm thick discs bonded together.
PCM	An acronym for Pulse Code Modulation - another name for digital audio.
PBC (PLAYBACK CONTROL)	This is recorded on a video CD (version 2.0). Selected scenes or information can be chosen from the menu displayed on the TV monitor.
REGION NUMBER	Both the DVD player and DVD discs are encoded with a region number. If the region number on the DVD disc does not correspond to the region number of the DVD player, the player cannot play the disc.
SUBTITLES	Translated appearing at the bottom of the screen. A DVD disc can contain up to 32 subtitle languages.
TITLE NUMBER	These numbers are recorded on DVD discs. When a disc contains two or more movies, these movies are numbered as Title 1, Title 2, etc.
TRACK NUMBER	These numbers are assigned to the tracks which are recorded on video and audio CDs. They enable specific tracks to be located quickly.
VIDEO CD	Contains recordings of pictures and sound whose quality is roughly comparable to that of video tape. This player also supports video CDs with playback control (version 2.0).
	You can enjoy 5.1 (or 6) channels of high fidelity digital sound from various digital input sources such as DVD, CD etc. DTS provides a realistic, clear surround sound that has not previously been available from conventional surround sound.
	5.1 (or 6) Channel Digital Surround sound reproduced from DVDs and LDs recorded as a digital signals (with  disc marking). With better sound quality, dynamic range, and directionality than traditional Dolby surround technology, you can enjoy dynamic, realistic sound.
	A 4 channel analog sound reproduced from a program source such as a videotape or LD with the  mark. You can enjoy a more realistic, robust sound unavailable from regular stereo sources.

Free Manuals Download Website

<http://myh66.com>

<http://usermanuals.us>

<http://www.somanuals.com>

<http://www.4manuals.cc>

<http://www.manual-lib.com>

<http://www.404manual.com>

<http://www.luxmanual.com>

<http://aubethermostatmanual.com>

Golf course search by state

<http://golfingnear.com>

Email search by domain

<http://emailbydomain.com>

Auto manuals search

<http://auto.somanuals.com>

TV manuals search

<http://tv.somanuals.com>