

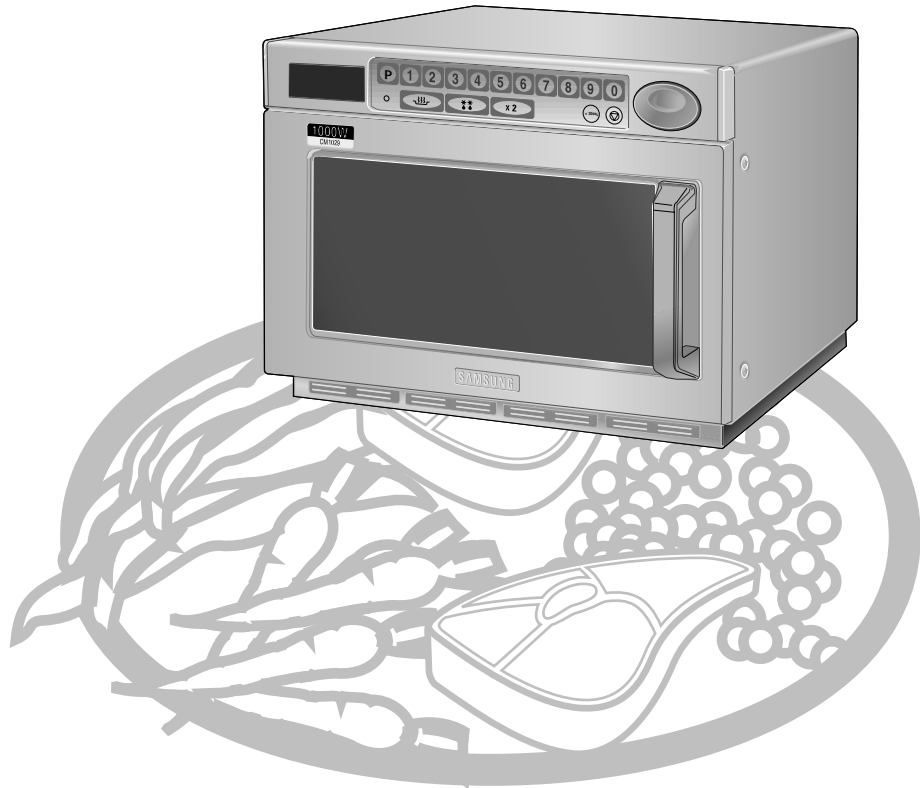

# MICROWAVE OVEN

CM1029(1000Watts)

## Owner's Instructions



GB



*You have just purchased a SAMSUNG microwave oven.*

*Your Owner's Instructions contain valuable information on cooking with your microwave oven. Take the time to read them as they will help you take full advantage of the microwave oven features.*

## Contents

◆ Oven Features	
■ Oven .....	3
■ Control Panel .....	4
■ Using this Instruction Booklet .....	5
◆ Installing and Preparing Your Microwave Oven	
■ Safety Precautions .....	6
■ Installing Your Microwave Oven .....	8
■ Cleaning Your Microwave Oven .....	9
■ Storing and Repairing Your Microwave Oven .....	9
■ Cookware Guide .....	10
◆ Cooking with Your Microwave Oven	
■ Cooking/Reheating .....	11
■ Power Levels and Time Variations .....	12
■ Repeat Feature .....	12
■ Using +30sec pad .....	13
■ Using the Defrost Feature .....	13
■ Memory Pads Programming .....	14
■ How to Operate Memory Cooking .....	15
■ Stopping the Cooking .....	15
■ Double Quantity Pad Programming .....	16
■ How to Operate Double Quantity Pad .....	17
■ Controlling Beep Tone .....	17
■ Error Codes .....	17
■ Hidden Keys .....	18
◆ Recommendations for Use	
■ Care of Your Microwave Oven .....	19
■ Programming Air Filter Clean Time .....	20
■ Replacement of Lamp .....	21
■ Cooking Guide .....	22
■ Technical Specifications .....	26

# Oven

GB

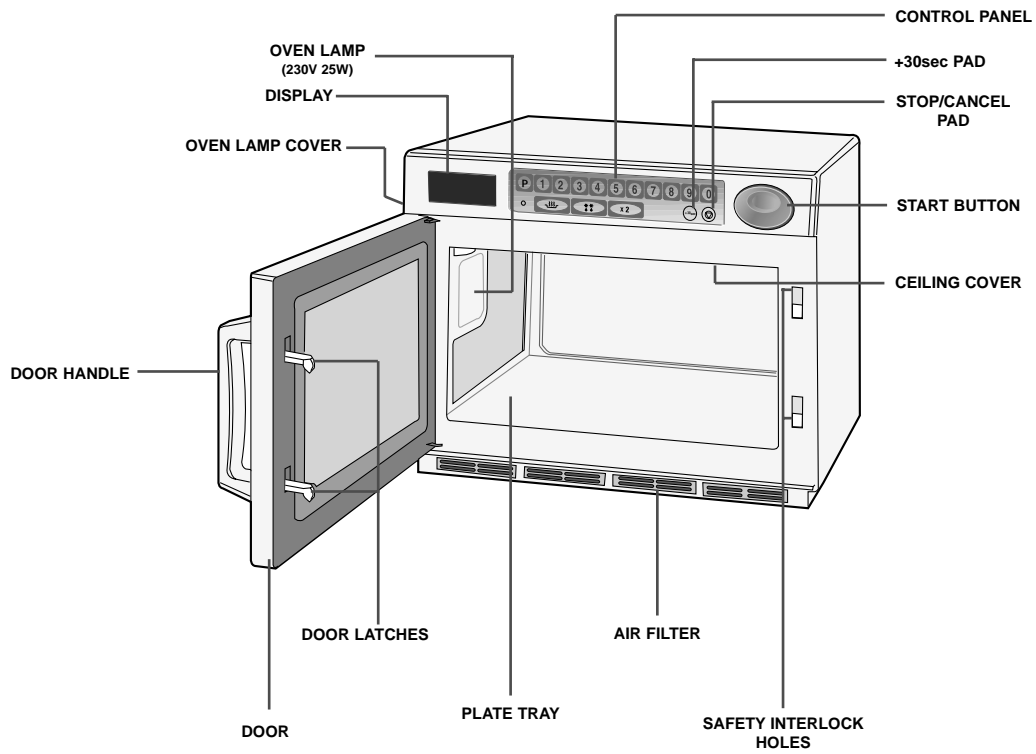

# Control Panel

GB

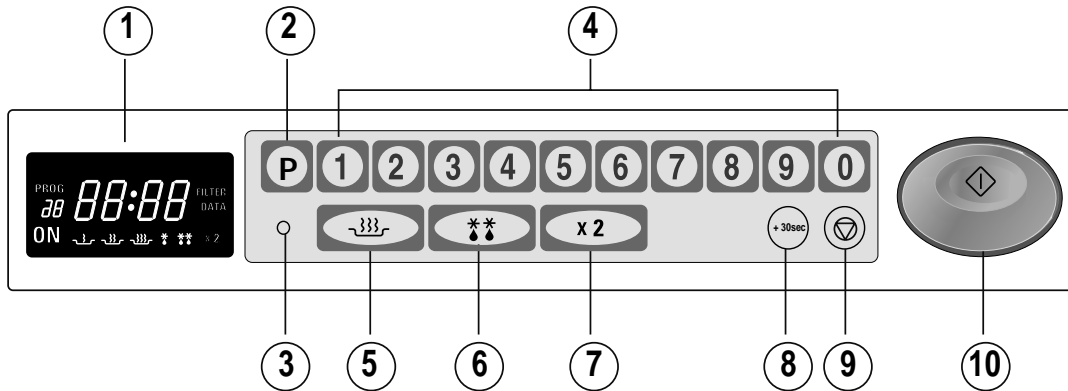

1. DISPLAY
2. PROGRAM PAD
3. PROGRAM LOCK PAD
4. NUMBER PADS(Time, Memory Programming)
5. POWER LEVEL SELECTOR PAD
6. DEFROST SELECTOR PAD
7. DOUBLE QUANTITY PAD
8. +30sec PAD (One Touch Cook Pad)
9. STOP/CANCEL PAD
10. START BUTTON

## DISPLAY

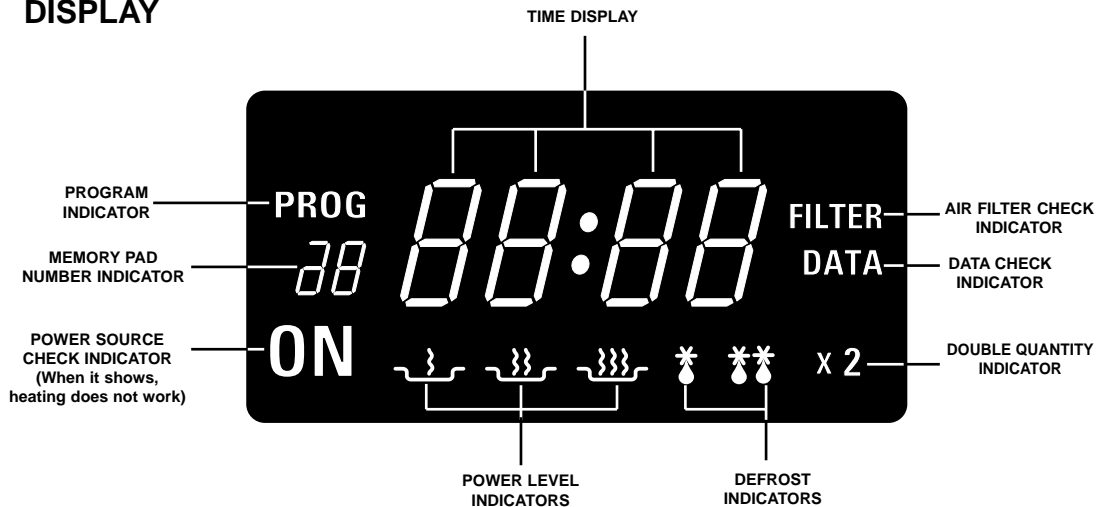

## Using this Instruction Booklet

GB

*You have just purchased a SAMSUNG microwave oven. Your Owner's Instructions contain valuable information on cooking with your microwave oven:*

- ◆ *Safety precautions*
- ◆ *Suitable cookware*
- ◆ *Useful cooking tips*

*At the start of the booklet you will find illustrations of the oven, and more importantly the control panel corresponding to your microwave model type, so that you can find the buttons more easily.*

*The step-by-step procedures use the different symbols below.*



**Press**



**Important**



**Note**

### **PRECAUTIONS TO AVOID POSSIBLE EXPOSURE TO EXCESSIVE MICROWAVE ENERGY**

#### ◆ **WARNING** ◆

Failure to observe the following safety precautions may result in harmful exposure to microwave energy.

- (a) Under no circumstances should any attempt be made to operate the oven with the door open or to tamper with the safety interlocks (door latches) or to insert anything into the safety interlock holes.
- (b) Do not place any object between the oven door and front face or allow food or cleaner residues to accumulate on sealing surfaces. Ensure that the door and door sealing surfaces are kept clean by wiping after use first with a damp cloth and then with a soft dry cloth.
- (c) Do not operate the oven if it is damaged until it has been repaired by a qualified microwave service technician trained by the manufacturer.

It is particularly important that the oven door closes properly and that there is no damage to the:

- (1) Door, door seals and sealing surfaces
  - (2) Door hinges (broken or loose)
  - (3) Power cable
- (d) The oven should not be adjusted or repaired by anyone other than a properly qualified microwave service technician trained by the manufacturer.

## Safety Precautions

***Before cooking food or liquids in your microwave oven, please check that the following safety precautions are taken.***

---

**1** DO NOT use any metallic cookware in the microwave oven:

- ◆ Metallic containers
- ◆ Dinnerware with gold or silver trimmings
- ◆ Skewers, forks, etc.

Reason: Electric arcing or sparking may occur and may damage the oven.

---

**2** DO NOT operate the microwave oven when it is empty.

Reason: The oven walls may be damaged.

Tip: Leave a glass of water inside the oven at all times. The water will absorb the microwaves if you accidentally set the oven going when it is empty.

---

**3** DO NOT cover the rear ventilation ducts with cloths or paper.

Reason: The cloths or paper may catch fire as hot air is expelled from the oven.

---

**4** ALWAYS use oven gloves when removing a dish from the oven.

Reason: Some dishes absorb microwaves and heat is always transferred from the food to the dish. The dishes are therefore hot.

---

**5** To reduce the risk of fire in the oven cavity:

- ◆ Do not store flammable materials in the oven
  - ◆ Remove wire twist ties from paper or plastic bags
  - ◆ Do not use your microwave oven to dry newspapers
  - ◆ If smoke is observed, keep the oven door closed and switch off or disconnect the oven from the power supply
- 

**6** Be careful not to damage the power cable.

- ◆ Do not immerse the power cable or plug in water and keep the power cable away from heated surfaces.
  - ◆ Do not operate this appliance if it has a damaged power cable or plug.
- 

**7** Stand at arm's length from the oven when opening the door.

Reason: The hot air or steam released may cause scalding.

---

**8** Keep the inside of the oven clean.

- ◆ Clean the inside of the oven after each use with a mild detergent solution, but let the microwave oven cool down before cleaning in order to avoid injury.

Reason: Food particles or spattered oils stuck to oven walls or top can cause damage to the ceiling cover and reduce the efficiency of the oven.

---

**9** "Clicking" sound might be noticed while operating, especially at defrosting mode.

Reason: When the power output is changing electrically, you may hear this sound. This is normal.

---

## Safety Precautions (continued)

GB

### ◆ WARNING ◆

#### **DO NOT heat:**

- ◆ Airtight or vacuum-sealed bottles, jars, containers  
Example: Baby food jars

- ◆ Airtight food - Food with skins  
Example: Eggs, nuts in shells, tomatoes

Reason: The increase in pressure may cause them to explode.

Tip: Remove lids and pierce skins, bags, etc.

#### **Take particular care when heating liquids and baby foods.**

- ◆ ALWAYS allow a standing time of at least 30 seconds after the oven has been switched off to allow the temperature to equalize.
- ◆ Stir during heating if necessary and ALWAYS stir after heating.
- ◆ To prevent eruptive boiling and possible scalding, you should stir before, during, and after heating.
- ◆ In the event of scalding, follow these FIRST AID instructions:
  - Immerse the scalded area in cold water for at least 10 minutes.
  - Cover with a clean, dry dressing.
  - Do not apply any creams, oils or lotions.
- ◆ NEVER fill the container to the top and choose a container that is wider at the top than at the bottom to prevent the liquid from boiling over. Bottles with narrow necks may also explode if overheated.
- ◆ ALWAYS check the temperature of baby food or milk before giving it to the baby.
- ◆ NEVER heat a baby's bottle with the teat on, as the bottle may explode if overheated.
- ◆ During microwave heating of beverages, there are results in delayed eruptive boiling, therefore care has to be taken when handling the container.

#### **IMPORTANT SAFETY INSTRUCTIONS**

*During cooking, you should look into the oven from time to time when food is being heated or cooked in disposable containers of plastic, paper or other combustible materials.*

#### **IMPORTANT**

*Young children should NEVER be allowed to use or play with the microwave oven.*

*Nor should they be left unattended near the microwave oven when it is in use.*

*Items of interest to children should not be stored or hidden just above the oven.*

## Installing your Microwave Oven

### Recommendations

DO NOT install the microwave oven in hot or damp surroundings.

Example: Next to a traditional oven or radiator.

The power supply specifications of the oven must be respected and any extension cable used must be of the same standard as the power cable supplied with the oven.

Wipe the interior and the door seal with a damp cloth before using your microwave oven for the first time.

*This microwave oven can be placed almost anywhere (kitchen work surface or shelf, movable trolley, table).*



For your personal safety, this appliance must be:

- ◆ Properly earthed (3-pin plug)
- ◆ Plugged into a standard 230 Volt, 50 Hz, AC earthed socket

- 1** Install the oven on a flat, level, stable surface. Make sure there is adequate ventilation for your oven by leaving at least 10cm(four inches) of space behind and on the sides of the oven and 20cm(eight inches) above.
- 2** Never block the air vents as the oven may overheat and automatically switch itself off. It will remain inoperable until it has cooled sufficiently.
- 3** Remove all packing materials inside the oven.
- 4** Plug the cable into a 3-pin, earthed socket. If the power cable of this appliance is damaged, it must be replaced by a special cable as supplied from service centre.



Be sure to remove the protective film from outer case. The protective film is on the outer case to prevent scratches. When installing or before using, be sure to remove it.

### Outdoor Use

*This microwave oven is not designed for outdoor use.*

*You should use it indoors only.*

### During Air Cooling

*Do not turn power off while the cooling fan is automatically air-cooling for 1min.*



## Cleaning Your Microwave Oven

*The following parts of your microwave oven should be cleaned regularly to prevent grease and food particles from building up:*

- ◆ *Inside and outside surfaces*
- ◆ *Door and door seals*
- ◆ *Plate tray*



ALWAYS ensure that the door seals are clean and the door closes properly.

- 1 Clean the outside surfaces with a soft cloth and warm, soapy water. Rinse and dry.
- 2 Remove any splashes or stains on the inside surfaces with a soapy cloth. Rinse and dry.
- 3 To loosen hardened food particles and remove smells, place a cup of diluted lemon juice on the plate tray and heat for three minutes at maximum power.

### Recommendations

DO NOT spill water in the vents.

NEVER use any abrasive products or chemical solvents.

Take particular care when cleaning the door seals to ensure that no particles:

- ◆ Accumulate
- ◆ Prevent the door from closing correctly

## Storing and Repairing Your Microwave Oven

*A few simple precautions should be taken when storing or having your microwave oven serviced.*

*The oven must not be used if the door or door seals are damaged:*

- ◆ *Broken hinge*
- ◆ *Deteriorated seals*
- ◆ *Distorted or bent oven casing*

*Only a qualified microwave service technician should perform repairs.*



NEVER remove the outer casing from the oven. If the oven is faulty and needs servicing or you are in doubt about its condition:

- ◆ Unplug it from the wall socket
- ◆ Contact the nearest after-sales service centre

## Cookware Guide

To cook food in the microwave oven, the microwaves must be able to penetrate the food, without being reflected or absorbed by the dish used.

Care must therefore be taken when choosing the cookware. If the cookware is marked microwave-safe, you do not need to worry.

The following table lists various types of cookware and indicates whether and how they should be used in a microwave oven.

Cookware	Microwave-Safe	Comments
<b>Aluminium foil</b>	✓ X	Can be used in small quantities to protect areas against overcooking. Arcing can occur if the foil is too close to the oven wall or if too much foil is used.
<b>Browning plate</b>	✓	Do not preheat for more than three minutes.
<b>China and earthenware</b>	✓	Porcelain, pottery, glazed earthenware and bone china are usually suitable, unless decorated with a metal trim.
<b>Disposable polyester cardboard dishes</b>	✓	Some frozen foods are packaged in these dishes.
<b>Fast-food packaging</b>		
• Polystyrene cups and containers	✓	Can be used to warm food. Overheating may cause the polystyrene to melt.
• Paper bags or newspaper	X	May catch fire.
• Recycled paper or metal trims	X	May cause arcing.
<b>Glassware</b>		
• Oven-to-tableware	✓	Can be used, unless decorated with a metal trim.
• Fine glassware	✓	Can be used to warm foods or liquids. Delicate glass may break or crack if heated suddenly.
• Glass jars	✓	Must remove the lid. Suitable for warming only.
<b>Metal</b>		
• Dishes	X	May cause arcing or fire.
• Freezer bag twist ties	X	
<b>Paper</b>		
• Plates, cups, napkins and kitchen paper	✓	For short cooking times and warming. Also to absorb excess moisture.
• Recycled paper	X	May cause arcing.
<b>Plastic</b>		
• Containers	✓	Particularly if heat-resistant thermoplastic. Some other plastics may warp or discolour at high temperatures. Do not use Melamine plastic.
• Cling film	✓	Can be used to retain moisture. Should not touch the food. Take care when removing the film as hot steam will escape.
• Freezer bags	✓ X	Only if boilable or oven-proof. Should not be airtight. Prick with a fork, if necessary.
<b>Wax or grease-proof paper</b>	✓	Can be used to retain moisture and prevent spattering.

## Cooking/Reheating

*This oven is preset at the factory for automatic operation.*

- 1 Make sure the oven is plugged into a properly earthed electrical outlet and "ON" appears in the display window.

- 2 Open the door.  
The oven lamp will be turned on.



- 3 Put the food into a suitable container, place it in the centre of the oven and then close the door securely.

**Result:** The oven lamp will go off.

- 4 Select the desired power level by pressing the Power Level Selector pad.

**Result:** The selected power level will be displayed in the display window.



- 5 Set the desired heating time by pressing the Number pads.

**Result:** The selected time is displayed in the display window.



- 6 Press button:  
The oven lamp and cooling fan will be turned on.  
Heating will start.

The time on digital display will count down.

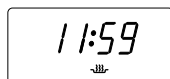

- 7 When all time is elapsed, the end of cycle Beep Tone will sound 4 times and all heating will stop. The oven lamp will go off. For 1 min, the display shows '0' and the cooling fan will keep working in order to cool down the interior parts. During the time, the fan will not stop even when you open the door. 1 min later it will stop and "ON" appears again. Food may be removed from oven whilst the fan is still running.



- 8 Open the door and take the food out.

- 9 Close the door. The oven lamp will go off.

- Whilst in a heating cycle, one press on pad stops the oven. At this time, the Power Check Indicator "ON" starts blinking and goes off when the pad or button is pressed again. You can restart it by pressing the button or a second press on pad will cancel the selected program. While NOT in a heating cycle, one tap on pad cancels the selected program. You can press +30sec pad one or more times in order to add the cooking time by 30 seconds. But you can not exceed the maximum time per power level allowed for power level selected.

GB

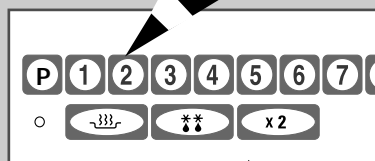
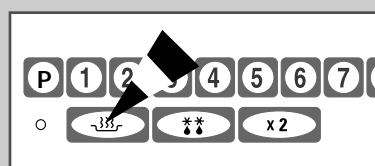





START BUTTON





- When you first plug in the power cord, the oven beeps once and all the indicators show for 5 sec in the display window.
- When heating cycle is completed and you open the door, the oven lamp automatically turns on and goes off 1 min later.
- When you open the door whilst in a heating cycle, the oven stops operating and the oven lamp automatically turns on for 1 min and goes off 1 min later. If you leave the oven door open for more than 1 min, the oven beeps once every minute and after 5 min the power source check indicator 'ON' appears in the display window.

## Power Levels and Time Variations

*The power level function enables you to adapt the amount of energy dissipated and thus the time required to cook or reheat your food, according to its type and quantity. You can choose between the power levels below.*

Power Level	Output	CM1029
HIGH(  )	100%	1000 W
MEDIUM(  )	70%	700 W
LOW(  )	50%	500 W
HIGH DEFROST(  )	30%	300 W
LOW DEFROST(  )	18%	180 W

*The cooking times given in recipes and in this booklet correspond to the specific power level indicated.*

Power Level	Max. Time
HIGH(  )	25 min.
MEDIUM(  )	40 min.
LOW(  )	40 min.
HIGH DEFROST(  )	50 min.
LOW DEFROST(  )	50 min.

*Power levels may be changed during the cooking/reheating cycle by pressing the power level pad or defrost selector pad. The oven doesn't need to be stopped to do this.*

## Repeat Feature

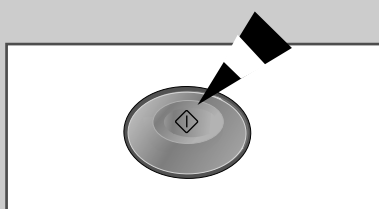

START BUTTON

12

- 1 You can repeat the previous cooking setting (regardless of manual or automatic memory heating) by pressing the START button. The oven starts with exactly the same heating time and power level that were used in the last operation.
- 2 The repeat feature will be cancelled once the power source is cut off.

## Using +30sec Pad

This is a **ONE TOUCH COOK** pad.

By touching the pad once, you can start heating instantly.

You can increase the cooking time by pressing the +30sec pad while heating is being done.

A cooking time increases by 30 seconds at each press on +30sec pad. But it can not exceed the maximum time.

Like traditional cooking, you may find that, depending on the food's characteristics or your tastes, you have to adjust the cooking times slightly. You can:

- ◆ Check how cooking is progressing at any time simply by opening the door
- ◆ Close the door
- ◆ Increase the remaining cooking time

Before operating the oven, times can be increased/decreased using either the time pads or +30sec button. During the operating, time may only be added by using the +30sec button.

## Using the Defrost Feature

The Defrost feature enables you to defrost meat, poultry or fish.



Use only containers that are microwave-safe.

- 1 Open the door.
- 2 Place the frozen food in the centre of the plate tray.
- 3 Close the door.
- 4 Press the Defrost selector pad to set DEFROST HIGH ( \*\* ) or DEFROST LOW ( \* ) as you wish.  
Result: The selected DEFROST indicator appears in the display.

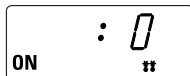

- 5 Press the Number pads to set the defrosting time. (Max. 50 min)



- 6 Press  button.  
Result: Defrosting begins.

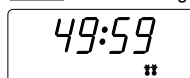

- It is not possible to set a defrosting time for longer than 50min. The defrost indicator will flash and it is advisable to press CANCEL and enter a new defrost level and time.

GB

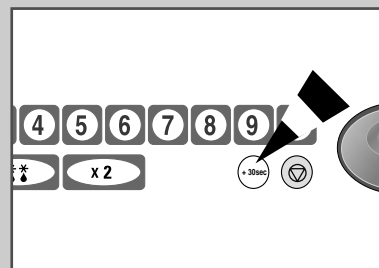

- When the oven was operating for longer than 25 min under Defrosting cycle, you can NOT change the power level from Defrosting to Heating(Cooking/Reheating) mode.

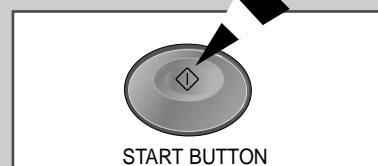
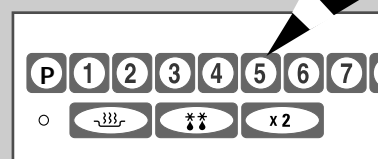
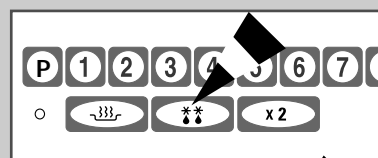

# Memory Pads Programming

GB

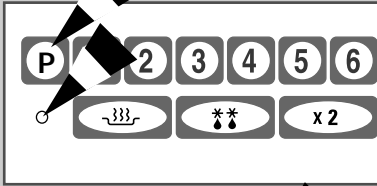

- 1 Hold down PROGRAM LOCK and then press PROGRAM pad. Hold together for 2 sec.

➤ Be sure to press the pads firmly.

Result: PROG indicator appears in the digital display.

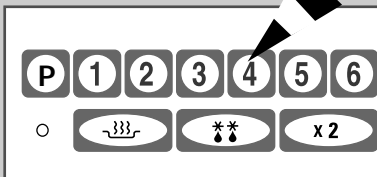

- 2 Press appropriate NUMBER pad for the desired memory number.

Result: Selected memory program code appears below the PROGRAM indicator.

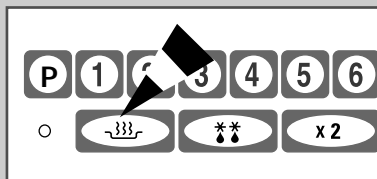
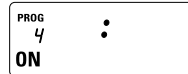

- 3 Select power level by pressing the POWER LEVEL pad.

Result: Default power level HIGH appears in the display at first press of the POWER LEVEL pad.

➤ Press the POWER LEVEL pad one or more times until you get the desired power level.

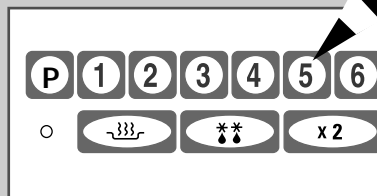
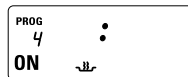

- 4 Press NUMBER pads to set the cooking time.

➤ The maximum time according to each cooking power level can be referred to in the title "Power Levels and Time Variations" on page 11-12. The NUMBER pads will not operate or respond when you press a cooking time exceeding the maximum value.

It is not possible to set a cooking time for longer than the maximum time allowed on the chosen program. The power level indicator will flash and it is advisable to press CANCEL and to enter a new power level and cooking time.

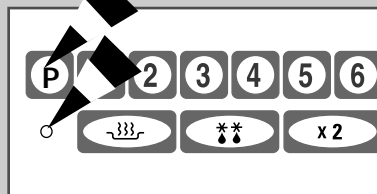
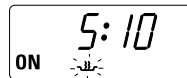

- 5 Hold down PROGRAM LOCK and then press PROGRAM pad. Hold together for 2 sec once again.

Result: PROG indicator and memory number indicator blink 3 times in the digital display with a beep sound. And then the display goes blank.

Caution: Be sure to press the pads firmly in the right position.



- 6 When you want to program more, repeat the procedures above again.

➤ Memory programs are available up to 20 items. Make sure the unit is properly programmed.

After programming is finished, all you have to do for memory cooking is to press the NUMBER pad. Then the selected memory program automatically starts cooking.



## How to Operate Memory Cooking

*After having finished memory programming, just press the NUMBER pad of the memory number you want to select. The oven will automatically start heating according to the pre-programmed cooking time and power level after a short delay (5 sec).*

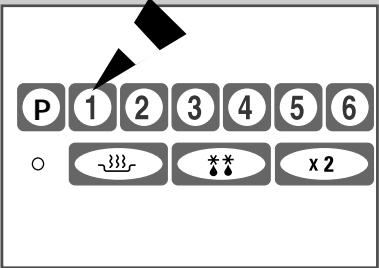

- 1 Make sure the oven is plugged into a properly earthed electrical outlet and "ON" appears in the display window.
  - 2 Open the door.  
The oven lamp will be turned on.
- ON
- 3 Put the food into a suitable container, place it in the centre of the oven and then close the door securely.  
Result: The oven lamp will go off.
  - 4 Press NUMBER pad.  
Result: After 2 seconds, the selected memory program automatically starts heating.



## Stopping the Cooking

*You can stop cooking at any time so that you can:*

- ◆ Check the food
- ◆ Turn the food over or stir it
- ◆ Leave it to stand

To stop the cooking...	Then...
Temporarily	<ul style="list-style-type: none"> <li>◆ Open the door or press  pad once.</li> </ul> <p><u>Result:</u> Cooking stops.</p> <p>To resume cooking, close the door and press  again.</p>
Completely	<p>Press the  pad twice.</p> <p><u>Result:</u> The cooking settings are cancelled.</p>

If you want to cancel any cooking settings before starting cooking, simply press CANCEL once.

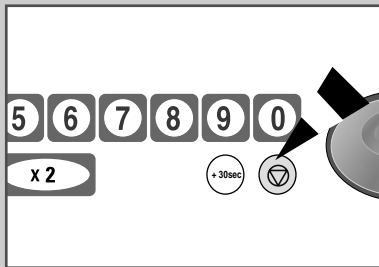

## Double Quantity Pad Programming

GB

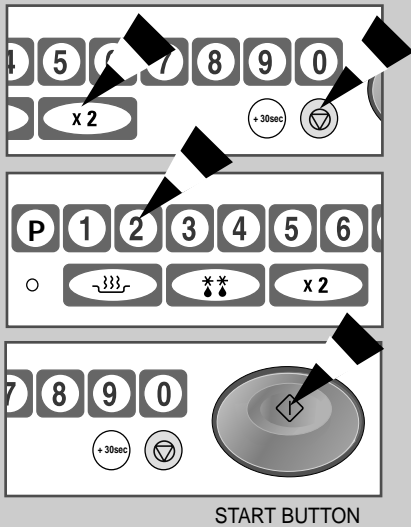

- 1 Hold down and then press pad. Hold together for 2 seconds.
- 2 Select desired program code by using NUMBER pads.
- 3 Press NUMBER pads to set the magnification factor within the range from 1.00 to 9.99.
  - Default factor is 1.65 preset from the manufacturer for increasing the cooking time.
  - Make sure that you set a correct factor between 1.00 and 9.99 for each memory code number.
- 4 Press button.
- 5 Press pad to exit the programming mode.
  - Though you can successfully set a double quantity factor whose setting might result in excess of the maximum time allowed for each power level, the oven does not operate exceeding the maximum time.

### Double Quantity Factor Editing

Feature	Key Entry	Display	Remark
Double Quantity Factor Edit	Hold down CANCEL and then  pad.		Hold down for 2 sec.
	Code No.		After 1 sec, default value shows in the display window.
	(Input desired factor value.)		1.00 ~ 9.99 available (Change the factor if required.)
	START		If you don't want to change more, press CANCEL to exit the editing mode.
	New Code No.		Skip this step if not necessary.
	(Input desired factor value.)		Skip this step if not necessary.
	START		Skip this step if not necessary.
	CANCEL	(Mode cancel)	This exits the editing mode.



## How to Operate Double Quantity Pad

- 1 Press the Double Quantity pad.
  - 2 Press the desired memory number pad.
- Result:** Cooking time which was multiplied by the preset factor appears in the display and cooking starts with time digits counting down.
- You don't need to press  button to start heating.

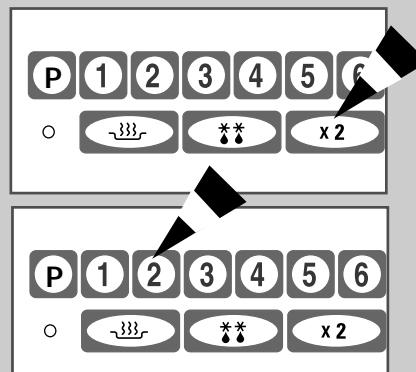

## Controlling Beep Tone

You can select the beep tone you require. There are 4 sound levels available.

- 1 Hold down  and then press NUMBER 0 pad. Hold together for 2 seconds.  
**Result:** Beep tone is changed to one level higher than current one.  
 ➤ Beep tone 0 does not make beep sound.
- Settings are circulating whenever you press the hidden keys in the following order.  
 Snd 0 → Snd 1 → Snd 2 → Snd 3 → Snd 0 (No sound)  
 ➤ Default tone is Snd 2.

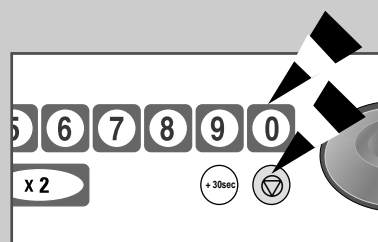





## Error Codes

Error Items	Code	Error Beep	Cause/Remedy
Power frequency Error(50/60Hz)	E1	One long beep for 2 sec	<p><b>Cause:</b> Power frequency is other than 50 Hz.</p> <p><b>Remedy:</b></p> <ul style="list-style-type: none"> <li>• Unplug the power cord plug and check if the power frequency is 50 Hz.</li> <li>• Plug the power cord in 50 Hz power source and see if "E1" appears. If the error code is displayed again even after the correct power source is provided, contact the nearest service centre.</li> </ul>
EEPROM Error	E5	One long beep for 2 sec	<p><b>Cause:</b> Memory IC (EEPROM IC) is not working correctly. In this case, other features except for memory function work properly. (You can operate the oven manually)</p> <p><b>Remedy:</b> Press CANCEL pad one or more times and try to start a memory heating. If the error code "E5" persists, contact your nearest service centre.</p>

## Hidden Keys

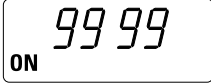
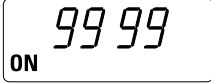
GB

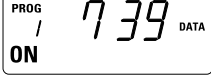
Note: Press Key 1 and then the next one. Hold for 2 secs.

Feature	Key Entry		Display	Remark
	Key 1	Next		
Continuity time total	CANCEL	1		Hold together for 2 sec. Unit: 10 hrs.
Magnetron oscillating time total	CANCEL	2		Hold together for 2 sec. Unit: 1 hr.
Number of times of use by memory program code	CANCEL	Start		Hold together for 2 sec.
	Code No.			
	(Data display after 2 sec.)			739 times of use
	(New code can be set after data display)			
	CANCEL		(Mode Cancel)	
Heating time per memory program code (Automatic sequential display)	CANCEL	P		Hold together for 2 sec.
			(Sequentially displays for 3 sec from 1 to 20)	
	CANCEL		(Mode Cancel)	

## Care of Your Microwave Oven

GB

### *Cleaning the Microwave Oven*

- 1 Unplug the oven from the electrical socket before cleaning.
- 2 Clean the inside of the oven. Wipe up all spills with a damp cloth. Kitchen detergent solution may be used if the oven gets too dirty. Do not use harsh detergents or abrasives.
  - If food remnant or spilled liquids stick to the oven walls, or between door seal and door surface, they will absorb microwaves possibly resulting in arcing or sparks.
- 3 Clean the outside of the oven with soap and water, then dry with a soft cloth. **Caution:** Make sure that water does not get into the back ventilation or control panel opening.
- 4 When you clean the window of the door, be sure to use a soft cloth after washing with very mild soap and water. Do not use window cleaner as the front door can be scratched by harsh soap or cleaners.

### *Cleaning the Ceiling Cover*

- 1 Hold side stoppers of ceiling cover with both hands and pull them in and down. Then take the ceiling cover out of the oven cavity.
- 2 Rinse ceiling cover in soapy water or Food Sanitizer Solution.
- 3 Be sure to replace the ceiling cover before using the oven.

**CAUTION** Ceiling cover must be in place securely when you use the oven. When you removed the Ceiling Cover for the purpose of cleaning, be sure to be extremely careful about the exposed inside components on the top of the oven cavity. If any of them are deformed, abnormal symptom can happen such as arcing or sparks during operation. In case of such problem, contact the nearest after-sales service centre.

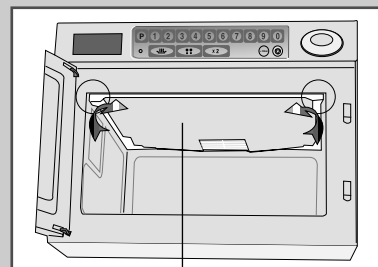

Ceiling Cover

GB

## Care of Your Microwave Oven (continued)

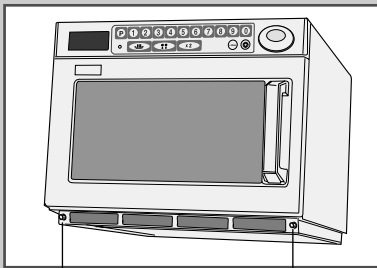

Bolt

### Cleaning the Air Filter

Clean the Air Filter regularly according to the following instructions. The oven may have problems when the Air Filter becomes clogged with dust.

- 1 Remove the bolt at both ends of the Air Filter.
- 2 Lift the Air Filter off the post carefully.
- 3 Wash this filter in warm soapy water.
- 4 Be sure to replace the Air Filter before using the oven.
  - If the Air Filter becomes clogged with debris, this will cause an overheating problem on the oven.
  - If the want to change the air filter clean time, refer to "Programming Air Filter Clean Time".

## Programming Air Filter Clean Time

When the air filter check indicator (FILTER) appears in the display window after a certain time of use, you should clean the air filter according to the instructions "Cleaning the Air Filter" on page 20 in this booklet. Then follow the procedure as below if you want to change the air filter clean time.

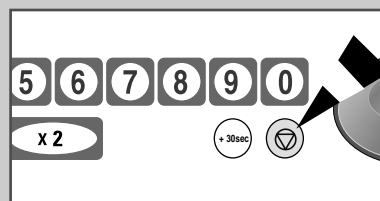
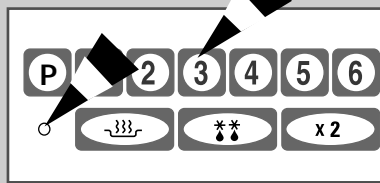
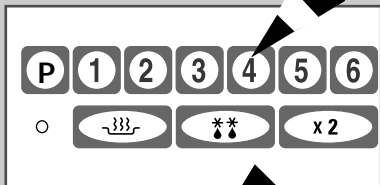
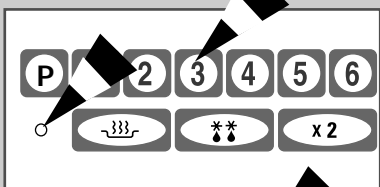

- 1 Hold down PROGRAM LOCK and then press NUMBER 3 pad. Hold together for 2 seconds.  
Result: The display will show the length of time in hours between cleaning the air filter you have programmed in or the original time preset by the manufacturer.
  - Default clean time is 500 hours in terms of pure oscillating time, not the continuity time.
- 2 Press NUMBER pads to set the desired clean time.
  - You can set up to 999 hours.
- 3 Hold down PROGRAM LOCK and then press NUMBER 3 pad. Hold together for 2 seconds in order to save the new value. This completes the programming of the air filter clean time.
- 4 Press CANCEL pad to return to cooking mode.
  - After the clean time has expired, you should clean the air filter.

## Replacement of Lamp

GB

### *Important*

- 1 Remove a screw securing the lamp cover.
  - > You don't need to remove outer panel to replace lamp.
- 2 Remove the lamp by rotating it clockwise.
- 3 Replace with a new lamp by rotating it counter-clockwise.

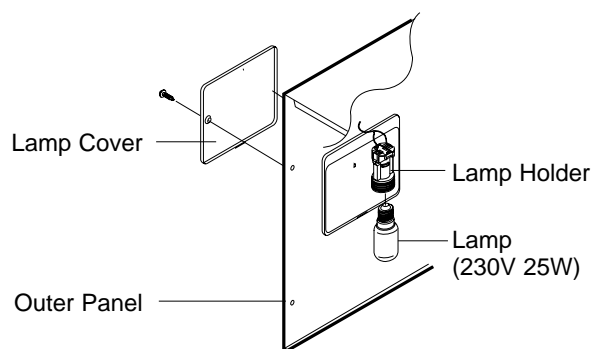

## Cooking Guide

GB

### Cooking Guide for fresh vegetables

Use a suitable glass pyrex bowl with lid. Cook covered for the minimum time - see table. Continue cooking to get the result you prefer. **Stir once during and once after cooking!** Add salt, herbs or butter after cooking. Cover during a standing time of 3 minutes.

**Hint: Cut the fresh vegetables into even sized pieces. The smaller they are cut, the quicker they will cook.**

Fresh Vegetables	Portion	Method	Power	Time (min.)	Standing Time(min.)
Broccoli	500 g	Cut into even sized florets. Add 60-75 ml cold water (4-5 tbsp.).	High	4-4 1/2	3
Brussel sprouts	500 g	Add 120-150 ml (8-10 tbsp.) water.	High	5-5 1/2	3
Carrots	500 g	Cut into even sized slices. Add 60-75 ml cold water (4-5 tbsp.).	High	4 1/2-5	3
Cauliflower	500 g	Cut into even sized florets. Add 60-75 ml cold water (4-5 tbsp.).	High	5-5 1/2	3
Green Beans	500 g	Cut into slices. Add 60-75 ml cold water (4-5 tbsp.).	High	5-5 1/2	3
Potatoes	500 g	Cut the peeled potatoes into halves. Add 60-75 ml cold water (4-5 tbsp.).	High	5-5 1/2	3

### Cooking Guide for frozen vegetables and frozen rice

Use a suitable glass pyrex bowl with lid. Cook covered for the minimum time - see table. Continue cooking to get the result you prefer. **Stir twice during cooking and once after cooking!** Add salt, herbs or butter after cooking. Cover during standing time.

Frozen Vegetables/Rice	Portion	Method	Power	Time (min.)	Standing Time(min.)
Cauliflower	500 g	Add 60-75 ml (4-5 tbsp.) cold water.	Medium	9 1/2 -10 1/2	3
Peas	500 g	Add 15-30 ml (1-2 tbsp.) cold water.	Medium	9 - 10	3
Mixed Vegetables (carrots, peas, corn)	500 g	Add 15-30 ml (1-2 tbsp.) cold water.	Medium	10-11	3
Mixed Vegetables (e.g. Ratatouille)	500 g	Add 15-30 ml (1-2 tbsp.) cold water.	Medium	10 1/2 -11 1/2	3
White Rice	500 g	Stir once or twice during reheating.	Medium	7-8	2-3
Rice + Vegetables	300 g	Stir once or twice during reheating.	Medium	6-7	2-3

## Cooking Guide

GB

### Reheating Soup and Stew

Use the power levels and times in this table as a guide lines for reheating.

Fresh Vegetables	Portion	Method	Power	Time (min.)	Standing Time(min.)
Soup (chilled)	250 g	Pour into a deep ceramic plate. Reheat covered. Stir during reheating.	High	2 -2½	2-3
Stew (chilled)	250 g 500 g	Pour into a deep ceramic plate or bowl. Reheat covered. Stir during reheating.	Medium	4½ -5 5½ -6	2-3
Bean Stew (canned)	350 g	Pour into a deep ceramic plate or bowl. Reheat covered. Stir during reheating.	Medium	3½ -4	2-3
Chilli (chilled)	350 g	Pour into a deep ceramic plate. Reheat covered. Stir during reheating.	Medium	4-4½	2-3
Soup (frozen)	500 g	Pour into a glass pyrex dish with lid. Reheat covered. Stir during reheating.	High	10-12	2-3

### Reheating Dish Entrees

Use the power levels and times in this table as a guide lines for reheating.

Fresh Vegetables	Portion	Method	Power	Time (min.)	Standing Time(min.)
Plated Meal (chilled)	350g	Plate a meal of 2-3 chilled components on a ceramic dish. Reheat covered.	Medium	3½ -4½	3
Chicken Curry & Rice (chilled)	300 g	Plate a meal of 2 chilled components on a ceramic dish (e. g rice and curry). Reheat covered.	Medium	2½ -3½	3
Pasta, plain (chilled)	500 g	Put the plain pasta in a glass pyrex bowl with lid. Reheat covered. Stir once ore twice during reheating.	Medium	4 - 5	1-2
Pasta with sauce (chilled)	350 g	Put pasta (e.g. spaghetti or egg noodles) on a flat ceramic plate. Reheat covered. Stir during reheating.	High	3 - 4	3
Filled pasta in	350 g	Put filled pasta (e.g. ravioli, tortellini) in a deep ceramic plate. Reheat covered. Stir occasionally during reheating.	Medium	4 - 5	3
Lasagne	400 g	Put chilled lasagne in an oval dish. Place the dish in the oven widthways. Reheat covered.	High	4½ -5½	3
Bechamel Potatoes (chilled)	400 g	Put bechamel potatoes on a flat ceramic plate. Reheat covered.	Medium	5½ -6½	3
Baked Potatoes (ready cooked and chilled)	500 g (2 x 250 g)	Pierce film and put potatoes on a flat ceramic plate.	High	3½ - 4½	2-3

## Cooking Guide

GB

### ***Cooking Breakfast***

Use the power levels and times in this table as a guide lines for cooking.

Fresh Vegetables	Portion	Method	Power	Time (min.)	Standing Time(min.)
Bacon (chilled)	2 slices à 20 g	Put bacon slices on kitchen paper on a flat ceramic plate.	High	ca 1½	1
Scrambled Eggs (chilled)	2 eggs	Beat eggs, add salt and 2 tbsp. milk. Put in a deep ceramic plate. Stir several times during cooking.	Medium	ca. 1½	1
Baked Beans (canned)	250 g	Put the beans in a deep ceramic plate. Reheat covered. Stir during reheating.	Medium	2½ -3	1-2

### ***Reheating Snacks***

Use the power levels and times in this table as a guide lines for cooking.

Fresh Vegetables	Portion	Method	Power	Time (min.)	Standing Time(min.)
Cheeseburger (frozen)	150 g (1pc)	Put burger on kitchen paper on a ceramic plate.	Medium	2 - 2½	2-3
Hot Dog (chilled)	125 g (1 pc)	Put hot dog on kitchen paper on a ceramic plate.	Medium	ca 1½	2-3
Pizza; Slice (chilled)	100 g	Put the pizza slice on a ceramic plate.	Low	1½ -2	1-2
Quiche/ Pie (chilled)	150 g	Put quiche on kitchen paper on a ceramic plate.	Medium	2-2½	2-3



## Cooking Guide

### ***Defrosting Bread and Cake***

Use the power levels and times in this table as a guide lines for cooking.

Fresh Vegetables	Portion	Method	Power	Time (min.)	Standing Time(min.)
Baguettes	150 g (1pc)	Put the baguette widthways on kitchen paper in the oven. Turn over after half of defrosting time.	Defrost 2	2-2½	3-5
Bread Rolls	8-10 pc a 50 g	Put the rolls side by side on kitchen paper in the oven. Turn over after half of defrosting time.	Defrost 2	4½ - 5	3-5
Croissants (defrosting & warming)	2 pc a 40 g	Put the croissants on kitchen paper on a ceramic plate.	High	ca 1/2	1-2
Cream Cake (slight defrosting)	100 g (1pc)	Put the piece of cake on a ceramic plate. Let stand until cream is totally defrosted.	Defrost 1	1 - 1½	10-20
Fruit Cake (defrosting & warming)	100 g (1pc)	Put the piece of cake on a ceramic plate.	Defrost 2	1½ - 2	5-10

### ***Defrosting or Reheating Desserts***

Use the power levels and times in this table as a guide lines for cooking.

Fresh Vegetables	Portion	Method	Power	Time (min.)	Standing Time(min.)
<b>Defrosting</b> Berries (frozen)	250 g	Distribute berries on a flat glass pyrex dish.	Defrost 2	5 - 6	5-10
<b>Cooking</b> Berries in sauce (chilled)	250 g	Put fruits in a glass pyrex bowl with lid. Reheat covered. Stir occasionally during cooking.	Medium	3 - 3½	2-3
<b>Warming</b> Puff Pastry, filled (frozen)	100 g	Put frozen pastry on kitchen paper on a ceramic plate.	Low	1½ - 2	1-2
<b>Reheating</b> Yeast Dumplings with jam filling (frozen)	300 g (3-4)	Put yeast dumplings side by side in a glass pyrex bowl with lid. Moist the top of them with cold water. Cook covered.	Medium	3½ - 4	2-3

## Technical Specifications

GB

*SAMSUNG strives to improve its products at all times. Both the design specifications and these user instructions are thus subject to change without notice.*

<b>Model</b>	<b>CM1029</b>
<b>Power source</b>	230 V ~ 50 Hz
<b>Power consumption</b> Microwave	1, 700 W
<b>Output power</b>	1, 000W (IEC-705)
<b>Operating frequency</b>	2, 450 MHz
<b>Dimensions (W x H x D)</b> Outside	464 x 368 x 557 mm
Oven cavity	370 x 190 x 370 mm
<b>Volume</b>	26 litre
<b>Net Weight</b>	26.5 Kg approx.

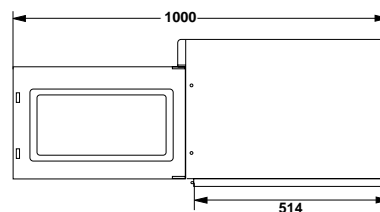
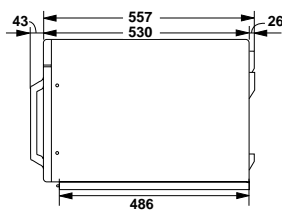
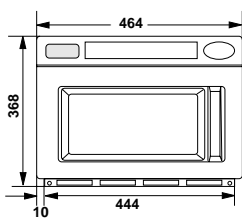

26

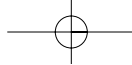

Memo

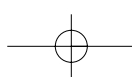
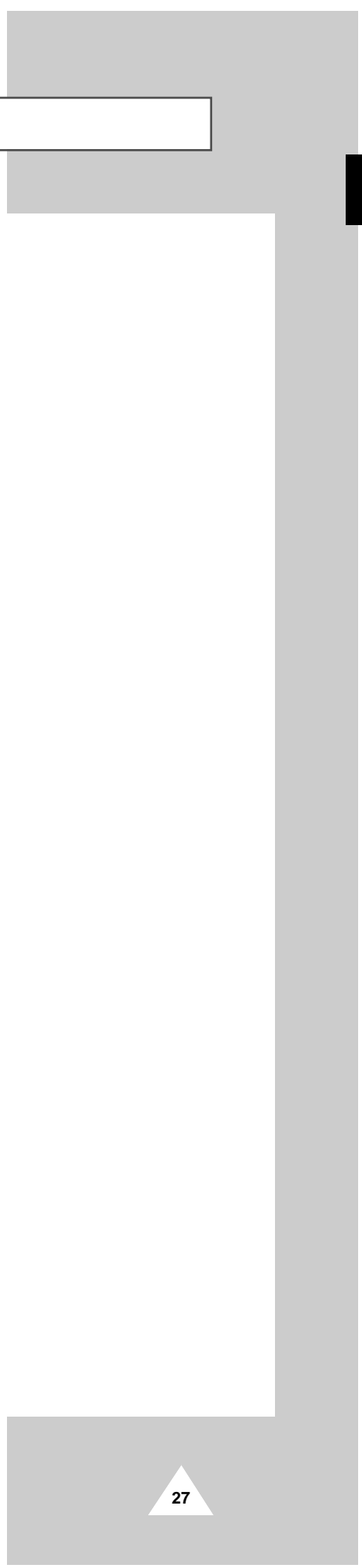
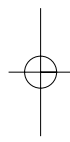
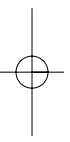

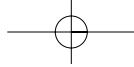

THIS APPLIANCE IS MANUFACTURED BY:

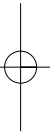
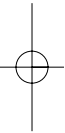

Printed in Korea

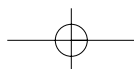

## Free Manuals Download Website

<http://myh66.com>

<http://usermanuals.us>

<http://www.somanuals.com>

<http://www.4manuals.cc>

<http://www.manual-lib.com>

<http://www.404manual.com>

<http://www.luxmanual.com>

<http://aubethermostatmanual.com>

Golf course search by state

<http://golfingnear.com>

Email search by domain

<http://emailbydomain.com>

Auto manuals search

<http://auto.somanuals.com>

TV manuals search

<http://tv.somanuals.com>