

SAMSUNG

MICROWAVE OVEN

Owner's Instructions and Cooking Guide

G2712N

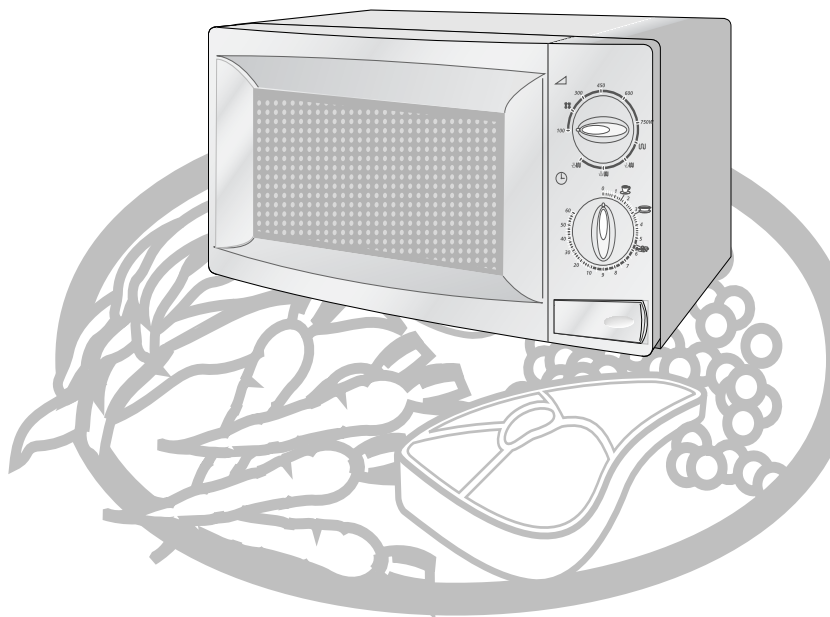

Oven.....	2
Accessories.....	2
Control Panel.....	2
Using this Instruction Booklet.....	3
Safety Precautions.....	3
Installing Your Microwave oven.....	4
What to Do if You are in Doubt or Have a Problem.....	5
Cooking / Reheating.....	5
Power Levels.....	5
Stopping the Cooking.....	6
Adjusting the Cooking Time.....	6
Manual Defrosting Food.....	6
Using the Instant Reheat/Cook Feature.....	6
Instant Reheat/Cook Settings.....	6
Choosing the Accessories.....	7
Grilling.....	7
Combining Microwaves and the Grill.....	7
Cookware Guide.....	8
Cooking Guide.....	9
Cleaning Your Microwave Oven.....	16
Technical Specifications.....	16

Oven

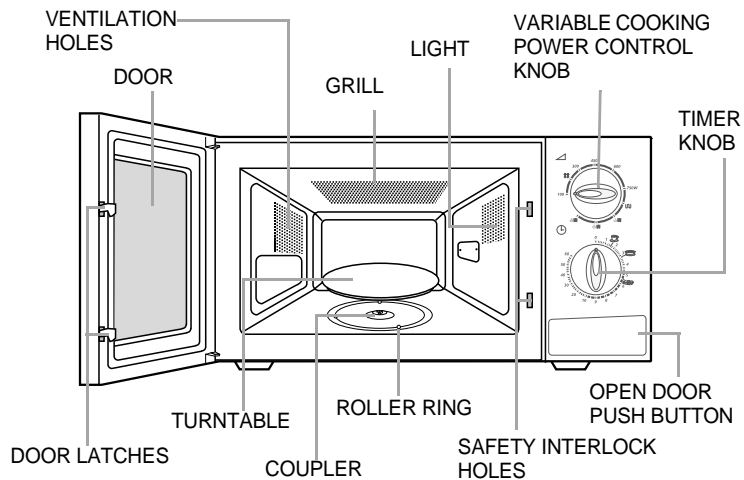

Accessories

Depending on the model that you have purchased, you are supplied with several accessories that can be used in a variety of ways.

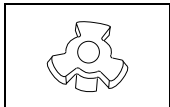

1. **Coupler**, already placed over the motor shaft in the base of the oven.

Purpose The coupler rotates the turntable.

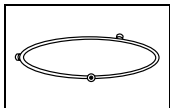

2. **Roller ring**, to be placed in the centre of the oven.

Purpose The roller ring supports the turntable.

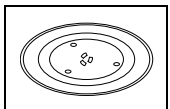

3. **Turntable**, to be placed on the roller ring with the centre fitting to the coupler.

Purpose The turntable serves as the main cooking surface; it can be easily removed for cleaning.

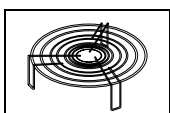

4. **Metal rack**, to be placed on the turntable.

Purpose The metal rack can be used in grill and combination cooking.



DO NOT operate the microwave oven without the roller ring and turntable.

Control Panel

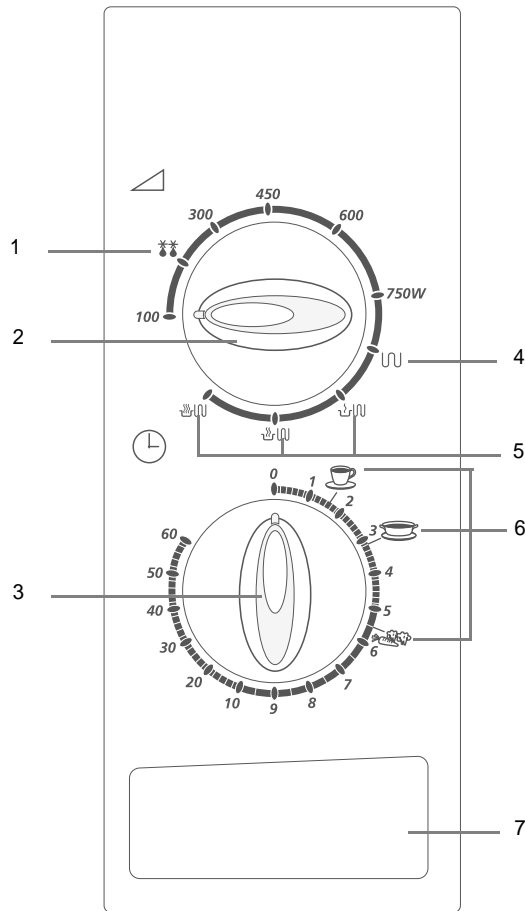

1. DEFROST
2. COOKING POWER CONTROL KNOB
3. TIMER KNOB
4. GRILL
5. COMBI
6. INSTANT REHEAT
7. OPEN DOOR PUSH BUTTON

Using this Instruction Booklet

You have just purchased a SAMSUNG microwave oven. Your Owner's Instructions contain much valuable information on cooking with your microwave oven:

- Safety precautions
- Suitable accessories and cookware
- Useful cooking tips

At the front of the booklet you will find illustrations of the oven, and more importantly the control panel, so that you can find the buttons more easily.

The step-by-step procedures use three different symbols.



Important



Note



Caution

PRECAUTIONS TO AVOID POSSIBLE EXPOSURE TO EXCESSIVE MICROWAVE ENERGY

Failure to observe the following safety precautions may result in harmful exposure to microwave energy.

- Under no circumstances should any attempt be made to operate the oven with the door open or to tamper with the safety interlocks (door latches) or to insert anything into the safety interlock holes.
- Do not place any object between the oven door and front face or allow food or cleaner residues to accumulate on sealing surfaces. Ensure that the door and door sealing surfaces are kept clean by wiping after use first with a damp cloth and then with a soft dry cloth.
- Do not operate the oven if it is damaged until it has been repaired by a qualified microwave service technician trained by the manufacturer. It is particularly important that the oven door closes properly and that there is no damage to the:
 - Door, door seals and sealing surfaces
 - Door hinges (broken or loose)
 - Power cable
- The oven should not be adjusted or repaired by anyone other than a properly qualified microwave service technician trained by the manufacturer.

Safety Precautions

IMPORTANT SAFETY INSTRUCTIONS.

READ CAREFULLY AND KEEP FOR FUTURE REFERENCE.

Before cooking food or liquids in your microwave oven, please check that the following safety precautions are taken.

- DO NOT** use any metallic cookware in the microwave oven:
 - Metallic containers
 - Dinnerware with gold or silver trimmings
 - Skewers, forks, etc.

Reason: Electric arcing or sparking may occur and may damage the oven.
- DO NOT** heat:
 - Airtight or vacuum-sealed bottles, jars, containers Ex) Baby food jars
 - Airtight food. Ex) Eggs, nuts in shells, tomatoes

Reason: The increase in pressure may cause them to explode.

Tip: Remove lids and pierce skins, bags, etc.
- DO NOT** operate the microwave oven when it is empty.

Reason: The oven walls may be damaged.

Tip: Leave a glass of water inside the oven at all times.

The water will absorb the microwaves if you accidentally set the oven going when it is empty.
- DO NOT** cover the rear ventilation slots with cloths or paper.

Reason: The cloths or paper may catch fire as hot air is evacuated from the oven.
- ALWAYS** use oven gloves when removing a dish from the oven.

Reason: Some dishes absorb microwaves and heat is always transferred from the food to the dish. The dishes are therefore hot.
- DO NOT** touch heating elements or interior oven walls.

Reason: These walls may be hot enough to burn even after cooking has finished, even though they do not appear to be so. Do not allow inflammable materials to come into contact with any interior area of the oven. Let the oven cool down first.
- To reduce the risk of fire in the oven cavity:
 - Do not store flammable materials in the oven
 - Remove wire twist ties from paper or plastic bags
 - Do not use your microwave oven to dry newspapers
 - If smoke is observed, keep the oven door closed and switch off or disconnect the oven from the power supply
- Take particular care when heating liquids and baby foods.
 - ALWAYS allow a standing time of at least 20 seconds after the oven has been switched off so that the temperature can equalize.
 - Stir during heating, if necessary, and ALWAYS stir after heating.
 - Take care when handling the container after heating. You may burn yourself if the container is too hot.
 - A risk of delayed eruptive boiling exists.
 - To prevent delayed boiling and possible scalding, you should put a plastic spoon or glass stick into the beverages and stir before, during and after heating.

Reason: During the heating of liquids the boiling point can be delayed; this means that eruptive boiling can start after the container is removed from the oven. You may scald yourself.

Safety Precautions(continued)

- In the event of scalding, follow these FIRST AID instructions:
 - * Immerse the scalded area in cold water for at least 10 minutes.
 - * Cover with a clean, dry dressing.
 - * Do not apply any creams, oils or lotions.
 - NEVER** fill the container to the top and choose a container that is wider at the top than at the bottom to prevent the liquid from boiling over. Bottles with narrow necks may also explode if overheated.
 - ALWAYS** check the temperature of baby food or milk before giving it to the baby.
 - NEVER** heat a baby's bottle with the teat on, as the bottle may explode if overheated.
9. Be careful not to damage the power cable.
- Do not immerse the power cable or plug in water and keep the power cable away from heated surfaces.
 - Do not operate this appliance if it has a damaged power cable or plug.
10. Stand at arm's length from the oven when opening the door.
Reason: The hot air or steam released may cause scalding.
11. Keep the inside of the oven clean.
Reason: Food particles or spattered oils stuck to oven walls or floor can cause paint damage and reduce the efficiency of the oven.
12. You may notice a "Clicking" sound during operation(especially when the oven is in defrosting).
Reason: This sound is normal when the electrical power output is changing.
13. When the microwave oven is operating without any load, the power will be cut off automatically for safety. You can operate normally after letting it stand for over 30 minutes.

IMPORTANT SAFETY INSTRUCTIONS

During cooking, you should look into the oven from time to time when food is being heated or cooked in disposable containers of plastic, paper or other combustible materials.

IMPORTANT

Young children should **NEVER** be allowed to use or play with the microwave oven. Nor should they be left unattended near the microwave oven when it is in use. Items of interest to children should not be stored or hidden just above the oven.

WARNING:

If the door or door seals are damaged, the oven must not be operated until it has been repaired by a competent person.

WARNING:

It is hazardous for anyone other than a competent person to carry out any service or repair operation which involves the removal of a cover which gives protection against exposure to microwave energy.

WARNING:

Liquids and other foods must not be heated in sealed containers since they are liable to explode.

WARNING:

Only allow children to use the oven without supervision when adequate instructions have been given so that the child is able to use the oven in a safe way and understands the hazards of improper use.

Installing Your Microwave oven

Place the oven on a flat, level surface that strong enough to safely bear the weight of the oven.

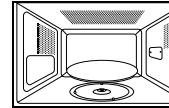
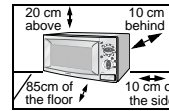

- When you install your oven, make sure there is adequate ventilation for your oven by leaving at least 10 cm (4 inches) of space behind and, on the sides of the oven and 20 cm (8 inches) of space above and 85 cm (33 inches) of the floor.
- Remove all packing materials inside the oven. Install the roller ring and turntable. Check that the turntable rotates freely.
- This microwave oven has to be positioned so that plug is accessible.



Never block the air vents as the oven may overheat and automatically switch itself off. It will remain inoperable until it has cooled sufficiently.



For your personal safety, plug the cable into a 3-pin, 230 Volt, 50Hz, AC earthed socket. If the power cable of this appliance is damaged, it must be replaced by a special cable (I-SHENG SP022, KDK KKP4819D, EUROELECTRIC 3410, SAMIL SP-106B, MOONSUNG EP-48E, HIGH PROJECT H.P 3). Contact your local dealer to have it replaced. The power cable of ISRAEL is PENCON(ZD16A), S/AFRICA APEX LEADS SA16 and NIGERIA, GHANA, KENYA and U.A.E is PENCON(UD13A1).



Do not install the microwave oven in hot or damp surroundings like next to a traditional oven or radiator. The power supply specifications of the oven must be respected and any extension cable used must be of the same standard as the power cable supplied with the oven. Wipe the interior and the door seal with a damp cloth before using your microwave oven for the first time.

What to Do if You are in Doubt or Have a Problem

If you have any of the problems listed below try the solutions given.

- ◆ This is normal.
 - Condensation inside the oven
 - Air flow around the door and outer casing
 - Light reflection around the door and outer casing
 - Steam escaping from around the door or vents
 - ◆ The oven does not start when you turn the **TIMER** knob.
 - Is the door completely closed?
 - ◆ The food is not cooked at all
 - Have you set the timer correctly?
 - Is the door closed?
 - Have you overloaded the electric circuit and caused a fuse to blow or a breaker to be triggered?
 - ◆ The food is either overcooked or undercooked
 - Was the appropriate cooking length set for the type of food?
 - Was an appropriate power level chosen?
 - ◆ Sparking and cracking occur inside the oven (arcing)
 - Have you used a dish with metal trimmings?
 - Have you left a fork or other metal utensil inside the oven?
 - Is aluminium foil too close to the inside walls?
 - ◆ The oven causes interference with radios or televisions
 - Slight interference may be observed on televisions or radios when the oven is operating. This is normal. To solve this problem, install the oven away from televisions, radios and aerials.
- ☒ If the above guidelines do not enable you to solve the problem, contact your local dealer or SAMSUNG after-sales service.

Cooking / Reheating

The following procedure explains how to cook or reheat food. **ALWAYS** check your cooking settings before leaving the oven unattended.

First, place the food in the centre of the turntable. Then, close the door.

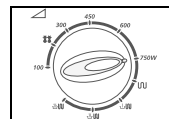

1. Set the power level to maximum by turning **COOKING POWER CONTROL** knob. (**MAXIMUM POWER: 750W**)

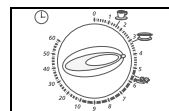

2. Set the time by turning **TIMER** knob.
Result : The oven light comes on and the turntable starts rotating.



Never switch the microwave oven on when it is empty.



You can change the power level during cooking by turning the **COOKING POWER CONTROL** knob.

Power Levels

You can choose among the power levels below.

Power Level	Output	
	MWO	GRILL
HIGH	750 W	-
MEDIUM HIGH	600 W	-
MEDIUM	450 W	-
MEDIUM LOW	300 W	-
DEFROST(☼☼)	180 W	-
LOW/KEEP WARM	100 W	-
GRILL	-	1000 W
COMBI I (☼☼☼)	300 W	1000 W
COMBI II (☼☼☼)	450 W	1000 W
COMBI III(☼☼☼)	600 W	1000 W



If you select higher power level, the cooking time must be decreased.



If you select lower power level, the cooking time must be increased.

Stopping the Cooking

You can stop cooking at any time to check the food.

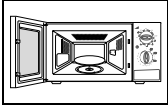

1. To stop temporarily;
Open the door.
Result : Cooking stops. To resume cooking, close the door.
2. To stop Completely;
Turn the **TIMER** knob to "0".

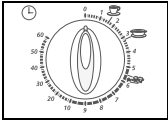

Adjusting the Cooking Time

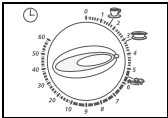

Adjust the remaining cooking time by rotating the **TIMER** knob.

Manual Defrosting Food

The Defrost feature enables you to defrost meat, poultry, fish or Bread/Cake. First, place the frozen food in the centre of the turntable and close the door..

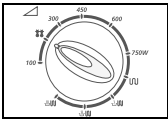

1. Turn the **COOKING POWER CONTROL** knob to ****** (180W).
2. Turn the **TIMER** knob to select the appropriate time.
Result : Defrosting begins.

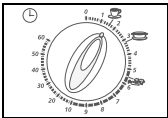

 Use only recipients that are microwave-safe.

Using the Instant Reheat/Cook Feature

First, place the food in the center of the turntable and close the door.

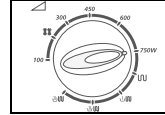

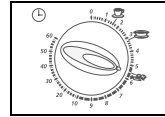

1. Turn the **COOKING POWER CONTROL** knob to Max Power.
2. Turn the **TIMER** knob to select Instant Reheat. (drinks or soup/sauce, fresh vegetables).



 Use only recipients that are microwave-safe.

Instant Reheat/Cook Settings

Here are a few tips and recommendations to be followed when cooking or reheating food with the Instant Reheat and Cooking Feature.

Symbols	Serving Type	Power	Portion	Cooking Time	Standing Time
	Drinks	750 W	150 ml	1 min 35 sec	1-2 min.
	Soup/Sauce (chilled)	750 W	200-250 ml	3 min 10 sec	2-3 min.
	Fresh vegetables	750 W	300-350 g	5 min 30 sec	3 min.

Choosing the Accessories

Use microwave-safe recipients; do not use plastic containers, dishes, paper cups, towels, etc.

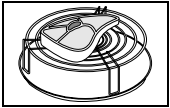

If you wish to select the combined cooking mode (grill and microwave), use only dishes that are microwave-safe and oven-proof. Metallic cookware or utensils may damage your oven.

- ☒ For further details on suitable cookware and utensils, refer to the Cookware Guide on page 8 .

Grilling

The grill enables you to heat and brown food quickly, without using microwaves. To this aim, a grill rack is supplied with your microwave oven.

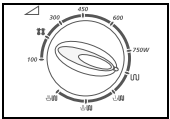

1. Preheat the grill to the required temperature, by turning the **cooking power control knob** to grill symbol (U) and turning the **TIMER** knob to the appropriate.

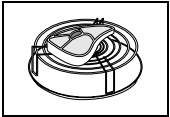

2. Open the door and place the food on the rack.

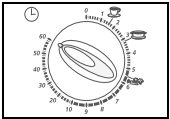

3. Select the appropriate cooking time by the turning the **TIMER** knob.
(Example : 60 minutes)
Result : Cooking start.

- ☒ Do not worry if the heater turns off and on while grilling. This system is designed to prevent overheating of the oven.

- ☞ Always use oven gloves when touching the dishes in the oven, as they will be very hot.

Combining Microwaves and the Grill

You can also combine microwave cooking with the grill, to cook quickly and brown at the same time.

- ☞ **ALWAYS** use microwave-safe and oven-proof cookware. Glass or ceramic dishes are ideal as they allow the microwaves to penetrate the food evenly.

- ☞ **ALWAYS** use oven gloves when touching the recipients in the oven, as they will be very hot.

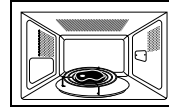

1. Open the oven door by pushing the large button in the bottom right-hand corner of the control panel. Place the food on the rack and the rack on the turntable. Close the door.

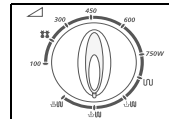

2. Turn the **Cooking Power Control knob** to the appropriate power Level (100 , 300 , 500).

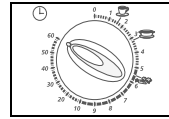

3. Turn the **TIMER** knob to select the appropriate time.
(Example : 60 minutes)
Result : Cooking start.

- ☒ The maximum microwave power for the combined microwave and grill mode is 600W.

Cookware Guide

GB *To cook food in the microwave oven, the microwaves must be able to penetrate the food, without being reflected or absorbed by the dish used.*

Care must therefore be taken when choosing the cookware. If the cookware is marked microwave-safe, you do not need to worry.

The following table lists various types of cookware and indicates whether and how they should be used in a microwave oven.

Cookware	Microwave-Safe	Comments
Aluminium foil	✓ X	Can be used in small quantities to protect areas against overcooking. Arcing can occur if the foil is too close to the oven wall or if too much foil is used.
Browning plate	✓	Do not preheat for more than eight minutes.
China and earthenware	✓	Porcelain, pottery, glazed earthenware and bone china are usually suitable, unless decorated with a metal trim.
Disposable polyester cardboard dishes	✓	Some frozen foods are packaged in these dishes.
Fast-food packaging		
• Polystyrene cups containers	✓	Can be used to warm food. Overheating may cause the polystyrene to melt. May catch fire.
• Paper bags or newspaper	X	
• Recycled paper or metal trims	X	
Glassware		
• Oven-to-table ware	✓	Can be used, unless decorated with a metal trim.
• Fine glassware	✓	Can be used to warm foods or liquids. Delicate glass may break or crack if heated suddenly.
• Glass jars	✓	Must remove the lid. Suitable for warming only.
Metal		
• Dishes	X	May cause arcing or fire.
• Freezer bag twist ties	X	

Paper			
• Plates, cups, napkins and Kitchen paper	✓		For short cooking times and warming. Also to absorb excess moisture.
• Recycled paper	X		May cause arcing.
Plastic			
• Containers	✓		Particularly if heat-resistant thermoplastic. Some other plastics may warp or discolour at high temperatures. Do not use Melamine plastic.
• Cling film	✓		Can be used to retain moisture. Should not touch the food. Take care when removing the film as hot steam will escape.
• Freezer bags	✓ X		Only if boilable or oven-proof. Should not be airtight. Prick with a fork, if necessary.
Wax or grease-proof paper	✓		Can be used to retain moisture and prevent spattering.

✓ :Recommended

✓X :Use Caution

X :Unsafe

Cooking Guide

MICROWAVES

Microwave energy actually penetrates food, attracted and absorbed by its water, fat and sugar content.

The microwaves cause the molecules in the food to move rapidly. The rapid movement of these molecules creates friction and the resulting heat cooks the food.

COOKING

Cookware for microwave cooking:

Cookware must allow microwave energy to pass through it for maximum efficiency. Microwaves are reflected by metal, such as stainless steel, aluminium and copper, but they can penetrate through ceramic, glass, porcelain and plastic as well as paper and wood. So food must never be cooked in metal containers.

Food suitable for microwave cooking:

Many kinds of food are suitable for microwave cooking, including fresh or frozen vegetables, fruit, pasta, rice, grains, beans, fish, and meat. Sauces, custard, soups, steamed puddings, preserves, and chutneys can also be cooked in a microwave oven. Generally speaking, microwave cooking is ideal for any food that would normally be prepared on a hob. Melting butter or chocolate, for example (see the chapter with tips, techniques and hints).

Covering during cooking

To cover the food during cooking is very important, as the evaporated water rises as steam and contributes to cooking process. Food can be covered in different ways: e.g. with a ceramic plate, plastic cover or microwave suitable cling film.

Standing times

After cooking is over food the standing time is important to allow the temperature to even out within the food.

Cooking Guide for frozen vegetables

Use a suitable glass pyrex bowl with lid. Cook covered for the minimum time - see table. Continue cooking to get the result you prefer.

Stir twice during cooking and once after cooking. Add salt, herbs or butter after cooking. Cover during standing time.

Food	Portion	Power	Time (min.)	Standing Time(min.)	Instructions
Spinach	150g	600W	5½-6½	2-3	Add 15 ml (1 tablespoon) cold water.
Broccoli	300g	600W	10-11	2-3	Add 15 ml (1 tbsp.) cold water.
Peas	300g	600W	8-9	2-3	Add 15 ml (1 tbsp.) cold water.
Green Beans	300g	600W	10-11	2-3	Add 15 ml (1 tbsp) cold water.
Mixed Vegetables (carrots/peas/corn)	300g	600W	9-10	2-3	Add 15 ml (1 tbsp.) cold water.
Mixed Vegetables (Chinese style)	300g	600W	8½-9½	2-3	Add 15 ml (1 tbsp) cold water.

Cooking Guide(continued)

Cooking Guide for rice and pasta

Rice: Use a large glass pyrex bowl with lid - rice doubles in volume during cooking. Cook covered.
After the cooking time is over, stir before standing time and salt or add herbs and butter.
Remark: the rice may not have absorbed all water after the cooking time is finished.

Pasta: Use a large glass pyrex bowl. Add boiling water, a pinch of salt and stir well. Cook uncovered.
Stir occasionally during and after cooking. Cover during standing time and drain thoroughly afterwards.

Food	Portion	Power	Time (min.)	Standing Time(min.)	Instructions
White Rice (parboiled)	250g	750W	17-18	5	Add 500 ml cold water.
Brown Rice (parboiled)	250g	750W	22-23	5	Add 500 ml cold water.
Mixed Rice (rice + wild rice)	250g	750W	18-19	5	Add 500 ml cold water.
Mixed Corn (rice + grain)	250g	750W	19-20	5	Add 400 ml cold water.
Pasta	250g	750W	11-12	5	Add 1000 ml hot water.

Cooking Guide for fresh vegetables

Use a suitable glass pyrex bowl with lid. Add 30-45 ml cold water (2-3 tbsp.) for every 250 g unless another water quantity is recommended - see table. Cook covered for the minimum time - see table. Continue cooking to get the result you prefer. Stir once during and once after cooking. Add salt, herbs or butter after cooking. Cover during a standing time of 3 minutes.

Hint: Cut the fresh vegetables into even sized pieces. The smaller they are cut, the quicker they will cook.

- **All fresh vegetables should be cooked using full microwave power (750 W).**

Food	Portion	Time (min.)	Standing Time (min.)	Instructions
Broccoli	250g 500g	5-5½ 8½-9	3	Prepare even sized florets. Arrange the stems to the centre.
Brussels Sprouts	250g	6½-7½	3	Add 60-75 ml (5-6 tbsp.) water.
Carrots	250g	5-6	3	Cut carrots into even sized slices.
Cauliflower	250g 500g	5½-6 9½-10	3	Prepare even sized florets. Cut big florets into halves. Arrange stems to the centre.
Courgettes	250g	4-4½	3	Cut courgettes into slices. Add 30 ml (2 tbsp.) water or a knob of butter. Cook until just tender.
Egg Plants	250g	4½-5	3	Cut egg plants into small slices and sprinkle with 1 tablespoon lemon juice.
Leeks	250g	5-5½	3	Cut leeks into thick slices.
Mushrooms	125g 250g	1½-2 3½-4	3	Prepare small whole or sliced mushrooms. Do not add any water. Sprinkle with lemon juice. Spice with salt and pepper. Drain before serving.
Onions	250g	5-6	3	Cut onions into slices or halves. Add only 15 ml (1 tbsp.) water.
Pepper	250g	4½-5	3	Cut pepper into small slices.
Potatoes	250g 500g	5-6 9-10	3	Weigh the peeled potatoes and cut them into similar sized halves or quarters.
Turnip Cabbage	250g	5-5½	3	Cut turnip cabbage into small cubes.

REHEATING

Your microwave oven will reheat food in a fraction of the time that conventional ovens hobs normally take.

Use the power levels and reheating times in the following chart as a guide. The times in the chart consider liquids with a room temperature of about +18 to +20°C or a chilled food with a temperature of about +5 to +7°C.

Arranging and covering

Avoid reheating large items such as joint of meat - they tend to overcook and dry out before the centre is piping hot. Reheating small pieces will be more successful.

Power levels and stirring

Some foods can be reheated using 750 W power while others should be reheated using 600 W, 450 W or even 300 W.

Check the tables for guidance. In general, it is better to reheat food using a lower power level, if the food is delicate, in large quantities, or if it is likely to heat up very quickly (mince pies, for example).

Stir well or turn food over during reheating for best results. When possible, stir again before serving.

Take particular care when heating liquids and baby foods. To prevent eruptive boiling of liquids and possible scalding, stir before, during and after heating. Keep them in the microwave oven during standing time. We recommend putting a plastic spoon or glass stick into the liquids. Avoid overheating (and therefore spoiling) the food.

It is preferable to underestimate cooking time and add extra heating time, if necessary.

Heating and standing times

When reheating food for the first time, it is helpful to make a note of the time taken - for future reference.

Always make sure that the reheated food is piping hot throughout.

Allow food to stand for a short time after reheating - to let the temperature even out. The recommended standing time after reheating is 2-4 minutes, unless another time is recommended in the chart.

Take particular care when heating liquids and baby food. See also the chapter with the safety precautions.

REHEATING LIQUIDS

Always allow a standing time of at least 20 seconds after the oven has been switched off to allow the temperature to even out. Stir during heating, if necessary, and ALWAYS stir after heating. To prevent eruptive boiling and possible scalding, you should put a spoon or glass stick into the beverages and stir before, during and after heating.

REHEATING BABY FOOD

- **BABY FOOD:** Empty into a deep ceramic plate. Cover with plastic lid. Stir well after reheating! Let stand for 2-3 minutes before serving. Stir again and check the temperature. Recommended serving temperature: between 30-40°C.

BABY MILK: Pour milk into a sterilised glass bottle. Reheat uncovered. Never heat a baby's bottle with teat on, as the bottle may explode if overheated. Shake well before standing time and again before serving! Always carefully check the temperature of baby milk or food before giving it to the baby. Recommended serving temperature: ca. 37°C.

REMARK:

Baby food particularly needs to be checked carefully before serving to prevent burns. Use the power levels and times in the next table as a guide lines for reheating.

Cooking Guide(continued)

Reheating Liquids and Food

Use the power levels and times in this table as a guide lines for reheating.

Food	Portion	Power	Time (min.)	Standing Time (min.)	Instructions
Drinks (coffee, milk, tea, water with room temperature)	150ml (1 cup) 250ml (1 mug)	750W	1½-2 2-2½	1-2	Pour in to a ceramic cup and reheat uncovered. Place cup (150ml) or mug (250ml) in the centre of turntable. Stir carefully before and after standing time.
Soup (chilled)	250g 450g	750W	3-3½ 4-4½	2-3	Pour into a deep ceramic plate. Cover with plastic lid. Stir well after reheating. Stir again before serving.
Stew (chilled)	350g	600W	5-6	2-3	Put stew in a deep ceramic plate. Cover with plastic lid. Stir occasionally during reheating and again before standing and serving.
Pasta with sauce (chilled)	350g	600W	4-5	3	Put pasta (e.g. spaghetti or egg noodles) on a flat ceramic plate. Cover with microwave cling film. Stir before serving.
Filled pasta with sauce (chilled)	350g	600W	4½-5½	3	Put filled pasta (e.g. ravioli, tortellini) in a deep ceramic plate. Cover with plastic lid. Stir occasionally during reheating and again before standing and serving.
Plated Meal (chilled)	300g 400g	600W	5-6 6-7	3	Plate a meal of 2-3 chilled components on a ceramic dish. Cover with microwave cling-film.

Food	Portion	Power	Time (min.)	Standing Time (min.)	Instructions
Frozen Ready Meal	300g 400g	600W	11½-12½ 13-14	4	Put microwave proof dish with frozen ready meal (-18°C) on the turntable. Pierce film or cover with microwave cling film. After reheating stand for 4 minutes.

Reheating Baby Food and Milk

Use the power levels and times in this table as guide lines for reheating.

Food	Portion	Power	Time	Standing Time (min.)	Instructions
Baby food (vegetables + meat)	190g	600W	30sec.	2-3	Empty into ceramic deep plate. Cook covered. Stir after cooking time. Stand for 2-3 minutes. Before serving, stir well and check the temperature carefully.
Baby porridge (grain + milk + fruit)	190g	600W	20sec.	2-3	Empty into ceramic deep plate. Cook covered. Stir after cooking time. Stand for 2-3 minutes. Before serving, stir well and check the temperature carefully.
Baby milk	100ml 200ml	300W	30-40sec. 1min. to 1min.10sec.	2-3	Stir or shake well and pour into a sterilised glass bottle. Place into the centre of turn-table. Cook uncovered. Shake well and stand for at least 3 minutes. Before serving, shake well and check the temperature carefully.

Cooking Guide(continued)

DEFROSTING

Microwaves are an excellent way of defrosting frozen food. Microwaves gently defrost frozen food in a short period of time. This can be of great advantage, if unexpected guests suddenly show up.

Frozen poultry must be thoroughly thawed before cooking. Remove any metal ties and take it out of any wrapping to allow thawed liquid to drain away.

Put the frozen food on a dish without cover. Turn over half way, drain off any liquid and remove any giblets as soon as possible.

Check the food occasionally to make sure that it does not feel warm.

If smaller and thinner parts of the frozen food start to warm up, they can be shield by wrapping very small strips of aluminium foil around them during defrosting.

Should poultry start to warm up on the outer surface, stop thawing and allow it to stand for 20 minutes before continuing.

Leave the fish, meat and poultry to stand in order to complete defrosting. The standing time for complete defrosting will vary depending on the quantity defrosted. Please refer to the table below.

Hint: Flat food defrosts better than thick and smaller quantities need less time than bigger ones. Remember this hint while freezing and defrosting food.

For defrosting of frozen food with a temperature of about -18 to -20 °C, use the following table as a guide.

All frozen food should be defrosted using defrosting power level (180 W, **).

Food	Portion	Time (min.)	Standing Time (min.)	Instructions
Meat	Minced beef	500g	10-12	5-20 Place the meat on a flat ceramic plate. Shield thinner edges with aluminium foil. Turn over after half of defrosting time!
	Pork steaks	250g	7-8	
Poultry	Chicken pieces	500g (2 pcs)	12-14	15-40 First, put chicken pieces first skin-side down, whole chicken first breast-side-down on a flat ceramic plate. Shield the thinner parts like wings and ends with aluminium foil. Turn over after half of defrosting time!
	Whole chicken	1000g	25-28	
Fish	Fish fillets	250g (2 pcs)	6-7	5-20 Put frozen fish in the middle of a flat ceramic plate. Arrange the thinner parts under the thicker parts. Shield narrow ends with aluminium foil. Turn over after half of defrosting time!
		400g (4 pcs)	11-13	
Fruits	Berries	250g	6-7	5 - 10 Distribute fruits on a flat, round glass dish (with a large diameter).
Bread	Bread rolls (each ca. 50 g)	2 pcs	1½-2	5 - 10 Arrange rolls in a circle or bread horizontally on kitchen paper in the middle of turntable. Turn over after half of defrosting time!
		4 pcs	3-4	
	Toast/ Sandwich	250g	4-5	
	German bread (wheat+ rye flour)	500g	8-10	

Cooking Guide(continued)

GRILL

The grill-heating element is located underneath the ceiling of the cavity. It operates while the door is closed and the turntable is rotating. The turntable's rotation makes the food brown more evenly. Preheating the grill for 4 minutes will make the food brown more quickly.

Cookware for grilling:

Should be flameproof and may include metal. Do not use any type of plastic cookware, as it can melt.

Food suitable for grilling:

Chops, sausages, steaks, hamburgers, bacon and gammon rashers, thin fish portions, sandwiches and all kinds of toast with toppings.

IMPORTANT REMARK:

Whenever the grill only mode is used, make sure that the grill-heating element is under the ceiling in the horizontal position and not on the back-wall in the vertical position. Please remember that food must be placed on the high rack, unless another instruction is recommended.

MICROWAVE + GRILL

This cooking mode combines the radiant heat that is coming from the grill with the speed of microwave cooking. It operates only while the door is closed and the turntable is rotating. Due to the rotation of the turntable, the food browns evenly. Three combination modes are available with this model:

600 W + Grill, 450 W + Grill and 300 W + Grill.

Cookware for cooking with microwave + grill

Please use cookware that microwaves can pass through. Cookware should be flameproof. Do not use metal cookware with combination mode. Do not use any type of plastic cookware, as it can melt.

Food suitable for microwave + grill cooking:

Food suitable for combination mode cooking include all kinds of cooked food which need reheating and browning (e.g. baked pasta), as well as foods which require a short cooking time to brown the top of the food. Also, this mode can be used for thick food portions that benefit from a browned and crispy top (e.g. chicken pieces, turning them over half way through cooking). Please refer to the grill table for further details.

IMPORTANT REMARK:

Whenever the combination mode (microwave + grill) is used, make sure that the grill heating element is under the ceiling in the horizontal position and not on the back-wall in the vertical position. The food should be placed on the high rack, unless another instruction is recommended. Otherwise it has to be placed directly on the turntable. Please refer to the instructions in the following chart.

The food must be turned over, if it is to be browned on both sides.

Grill Guide

Preheat the heater with the grill-function when grilling fresh and frozen food.

Use the power levels and times in this table as guide lines for grilling.

Fresh Food	Portion	Preheat Time (min.)	Power	1. Side Time (min)	2. Side Time (min.)	Instructions
Toast Slices	4 pcs (4 x 25g)	5	Grill only	6-7	5-6	Put the toast slices side by side on the rack.
Bread Rolls (already baked)	2-4 pieces	3	Grill only	3-4	2-3	Put bread rolls first with the bottom side up in a circle directly on the rack.
Grilled Tomatoes	250 g (2pcs)	5	300 W + Grill	5½-6½	--	Cut tomatoes into halves. Put salt, pepper and some cheese on top. Arrange in a circle in a flat glass pyrex dish. Place dish on the rack.
Toast Hawaii	2 pcs (300 g)	5	300 W + Grill	7-9	--	Toast the bread slices first. Put the toast with topping (ham, pineapple, cheese slices) side by side on the rack. After cooking stand for 2-3 minutes.
Chicken Wings (chilled)	400-500g (6pcs)	5	300 W + Grill	11-13	10-12	Prepare chicken pieces such as chicken wings or drumsticks with oil and spices. Put them in a circle on the rack with the bones to the middle. After grilling stand for 2-3 minutes.

Cooking Guide(continued)

Grill Guide (continued)

Fresh Food	Portion	Preheat Time (min.)	Power	1. Side Time (min)	2. Side Time (min.)	Instructions
Baked Potatoes	500 g	5	450 W + Grill	10-12	--	Cut potatoes into halves and put in a circle on the rack with the cut side to the grill. Brush cut side with olive oil and spices. After grilling stand for 3 minutes.
Frozen Pasta	400 g	---	600 W + Grill	14-16	3-4	Put the frozen pasta (-18°C), e.g. lasagne, tortellini or cannelloni in a suitable sized glass pyrex dish and set on rack.
Frozen Fish Gratin	400 g	---	600 W + Grill	16-18	3-4	Put the frozen fish gratin (-18°C) in a suitable sized glass pyrex dish and set on rack.
Frozen Pizza Snacks	250 g (8pcs)	---	300 W + Grill	12-13	---	Put the frozen pizza snacks (-18°C) or mini quiches in a circle on the rack.
Frozen Streusel Cake	200-250 g (1-2 pcs)	---	300 W + Grill	4-6	---	Put the frozen cake pieces (-18°C) side by side on rack. After defrosting stand for 5 minutes.

SPECIAL HINTS

MELTING BUTTER

Put 50 g butter into a small deep glass dish. Cover with plastic lid. Heat for 30-40 seconds using 750 W, until butter is melted.

MELTING CHOCOLATE

Put 100 g chocolate into a small deep glass dish. Heat for 3-5 minutes, using 450 W until chocolate is melted. Stir once or twice during melting. Use oven gloves while taking out!

MELTING CRYSTALLIZED HONEY

Put 20 g crystallized honey into a small deep glass dish. Heat for 20-30 seconds using 300 W, until honey is melted.

MELTING GELATINE

Lay dry gelatine sheets (10 g) for 5 minutes into cold water. Put drained gelatine into a small glass pyrex bowl. Heat for 1 minute using 300 W. Stir after melting.

COOKING GLAZE/ICING (FOR CAKE AND GATEAUX)

Mix instant glaze (approximately 14 g) with 40 g sugar and 250 ml cold water. Cook uncovered in a glass pyrex bowl for 3½ to 4½ minutes using 750 W, until glaze/icing is transparent. Stir twice during cooking.

COOKING JAM

Put 600 g fruits (for example mixed berries) in a suitable sized glass pyrex bowl with lid. Add 300 g preserving sugar and stir well. Cook covered for 10-12 minutes using 750 W. Stir several times during cooking. Empty directly into small jam glasses with twist-off lids. Stand on lid for 5 minutes.

COOKING PUDDING

Mix pudding powder with sugar and milk (500 ml) by following the manufacturers instructions and stir well. Use a suitable sized glass pyrex bowl with lid. Cook covered for 6½ to 7½ minutes using 750 W. Stir several times well during cooking.

BROWNING ALMOND SLICES

Spread 30 g sliced almonds evenly on a medium sized ceramic plate. Stir several times during browning for 3½ to 4½ minutes using 600 W. Let it stand for 2-3 minutes in the oven. Use oven gloves while taking out!

Cleaning Your Microwave Oven

GB The following parts of your microwave oven should be cleaned regularly to prevent grease and food particles from building up:

- *Inside and outside surfaces*
- *Door and door seals*
- *Turntable and Roller rings*

☞ **ALWAYS** ensure that the door seals are clean and the door closes properly.

☞ Failure to maintain the oven in a clean condition could lead to deterioration of the surface that could adversely affect the of the appliance and possibly result in a hazardous situation.

1. Clean the outside surfaces with a soft cloth and warm, soapy water. Rinse and dry.
2. Remove any splashes or stains on the inside surfaces or on the roller ring with a soapy cloth. Rinse and dry.
3. To loosen hardened food particles and remove smells, place a cup of diluted lemon juice on the turntable and heat for ten minutes at maximum power.
4. Wash the dishwasher-safe plate whenever necessary.

☒ **DO NOT** spill water in the vents. **NEVER** use any abrasive products or chemical solvents. Take particular care when cleaning the door seals to ensure that no particles:

- Accumulate
- Prevent the door from closing correctly

☒ Clean the microwave oven cavity right after each use with a mild detergent solution, but let the microwave oven cool down before cleaning in order to avoid injury.

Technical Specifications

SAMSUNG strives to improve its products at all times. Both the design specifications and these user instructions are thus subject to change without notice.

Model	G2712N
Power source	230V ~ 50 Hz
Power consumption	
Microwave	1100 W
Grill	1000 W
Combined mode	2100 W
Output power	100 W / 750 W (IEC-705)
Operating frequency	2450 MHz
Magnetron	OM75S(31)
Cooling method	Cooling fan motor
Dimensions (W x H x D)	
Outside	489 x 275 x 383 mm
Oven cavity	330 x 187 x 320 mm
Volume	20 liter
Weight	
Net	14.5 kg approx



Free Manuals Download Website

<http://myh66.com>

<http://usermanuals.us>

<http://www.somanuals.com>

<http://www.4manuals.cc>

<http://www.manual-lib.com>

<http://www.404manual.com>

<http://www.luxmanual.com>

<http://aubethermostatmanual.com>

Golf course search by state

<http://golfingnear.com>

Email search by domain

<http://emailbydomain.com>

Auto manuals search

<http://auto.somanuals.com>

TV manuals search

<http://tv.somanuals.com>