

SAMSUNG

Installation and Operating Instructions

Built-In Oven



BT620FQST
BT62FQPST
BT62FQBPST
BT62FQFST
BT62FQBFST



Owner's Manual

Download from www.Somanuals.com. All Manuals Search And Download.

Contents

Using This Manual	2
Safety Instructions	2
Electrical safety	2
Safety during operation	3
Disposal Instructions	3
Installing the Oven	4
Safety instructions for the installer	4
Installing into a low cabinet	4
Connecting to the mains power supply	5
Installing into a high cabinet	6
Parts and Features	7
Oven	7
Oven controls	8
Special features	8
Accessories	9
Using the accessories	11
Safety shutoff	11
Cooling fan	11
Before You Begin	12
Setting the clock	12
Initial cleaning	13
Oven Use	14
Setting the divider mode	14
Setting the oven temperature	18
Switching the oven off	19
End time	19
Cook time	21
Delayed start	23
Kitchen timer	25
Oven lamp on/off	25
Child safety function	26
Switching the beeper off	26
Oven functions	27
Test dishes	35
Cleaning and Care	36
Self cleaning	36
Steam cleaning	37
Cleaning the oven door	40
Changing the lamp	44
Warranty & Service	45
FAQs and Troubleshooting	45
Technical data	47

Using This Manual

Thank you for choosing a SAMSUNG Built - In Oven.

This Owner's Manual contains important information on safety and instructions intended to assist you in the operation and maintenance of your appliance.

Please take the time to read this Owner's Manual before using your oven and keep this book for future reference.

The following symbols are used in the text of this Owner's Manual.



Important



Note

Safety Instructions

Installation of this oven must be performed only by a licensed electrician. The installer is responsible for connecting the appliance to the mains power supply in observance of the relevant safety recommendations.

Electrical safety

If the oven has been damaged in transport, do not connect it.

- This appliance must be connected to the mains power supply only by a **specialty licensed electrician**.
- In the event of a fault or damage to the appliance, do not attempt to operate it.
- **Repairs** should be performed by a **licensed technician** only. Improper repair may result in considerable danger to you and others. If your oven needs repair, contact a SAMSUNG Service Centre or your dealer.
- If the supply cord is defective, it must be replaced by a special cord or assembly available from the manufacturer or an authorised service agent.
- Electrical leads and cables should not be allowed to touch the oven.
- The oven should be connected to the mains power supply by means of an approved circuit breaker or fuse. Never use multiple plug adapters or extension leads.
- The rating plate is located on the right side of the door.
- The power supply of the appliance should be turned off when it is being repaired or cleaned.
- This appliance is not intended for use by persons (including children) with reduced physical, sensory or mental capabilities, or lack of experience and knowledge, unless they have been given supervision or instruction concerning use of the appliance by a person responsible for their safety.

WARNING

Accessible parts may become hot during use. To avoid burns young children should be kept away.

WARNING

The appliance should be powered down before replacing the lamp to avoid the possibility of electric shock. During oven operation, the interior surfaces become very hot.

Safety Instructions (Continued)

EN

Safety during operation

- This oven has been designed only for the cooking of household foods.
- During use, the oven interior surfaces become hot enough to cause burns. Do not touch heating elements or interior surfaces of the oven until they have had time to cool.
- Never store flammable materials in the oven.
- The oven surfaces become hot when the appliance is operated at a high temperature for an extended period of time.
- When cooking, take care when opening the oven door as hot air and steam can escape rapidly.
- When cooking dishes that contain alcohol, the alcohol may evaporate due to the high temperatures and the vapour can catch fire if it comes into contact with a hot part of the oven.
- For your safety, do not use high-pressure water cleaners or steam jet cleaners.
- Children should be kept at a safe distance when the oven is in use.
- Frozen foods such as pizzas should be cooked on the wire grill. If the baking tray is used, it may become deformed due to the great variation in temperatures.
- Do not pour water into the oven bottom when it is hot. This could cause damage to the enamel surface.
- The oven door must be closed during cooking.
- Take care when opening the door before the end of the steam cleaning procedure; the water on the bottom is hot.
- Do not line the oven bottom with aluminium foil and do not place any baking trays or tins on it. The aluminium foil blocks the heat, which may result in damage to the enamel surfaces and cause poor cooking results.
- Fruit juices will leave stains, which can become indelible on the enamel surfaces of the oven. When cooking very moist cakes, use the deep pan.
- Do not rest bakeware on the open oven door.
- This appliance is not intended for use by young children or infirm persons without the adequate supervision of a responsible person ensuring that they are using the appliance safely.
- Young children should be supervised to ensure that they do not play with the appliance.
- Excess spillage should be removed before self cleaning and all utensils should not be left in the oven during pyrolytic self cleaning.
- During self cleaning the surfaces get hotter than usual and children should be kept a safe distance.

Disposal Instructions

Disposing of the packaging material

- The material used to package this appliance is recyclable.
- Dispose of the packaging materials in the appropriate container at your local waste disposal facility.

Disposing of old appliances

WARNING

Before disposing of old appliances, make them inoperable so that they cannot be a source of danger.

To do this, disconnect the appliance from the mains supply and remove the mains lead.

To protect the environment, it is important that old appliances are disposed of in the correct manner.

- The appliance must not be disposed of with household rubbish.
- You can obtain information about collection dates and public refuse disposal sites from your local refuse department or council.

Installing the Oven

EN

- ⚡ Electrical installation of this appliance must be performed only by a licensed electrician. The oven must be installed according to the instructions supplied. Remove the protective vinyl from the door after installation. Remove the protective tape from the interior surfaces of the oven after installation.

Safety instructions for the installer

- Installation must guarantee protection against exposure to electrically live parts.
- The unit in which the appliance is fitted must satisfy the requirements of DIN 68930 in respect of stability.

Installing into a low cabinet

- Observe minimum clearance requirements.
- Secure oven into place with screws on either side of the oven.

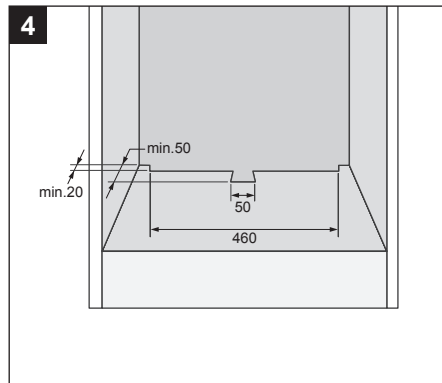
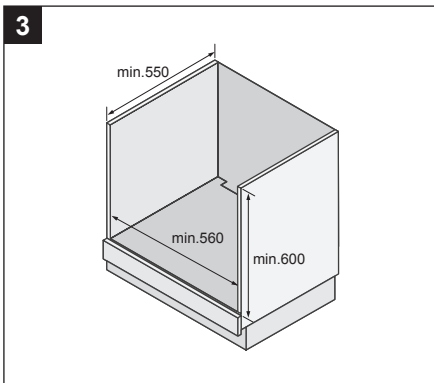
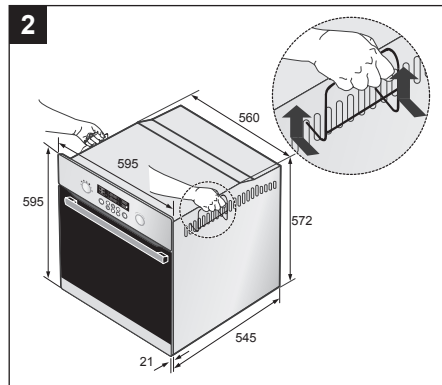
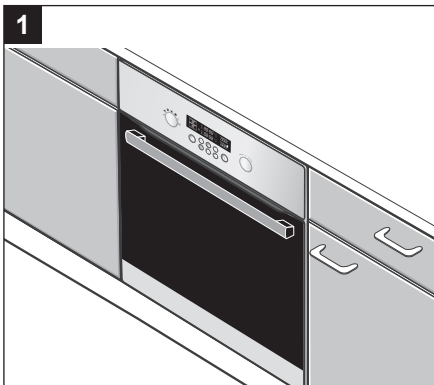

Installing the Oven (Continued)

5

Connecting the oven to the power supply
(H05VV-F, H05RR-F, Min 1.5m, 1.5~2.5mm²)

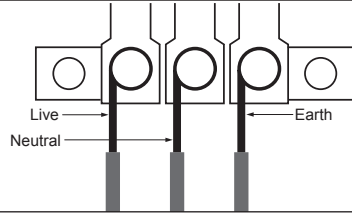

EN

Connecting to the mains power supply

Electrical connections must be made as per the connection plate fixed to the back of the appliance by an electrical fitter who must ensure that the appliance has been connected up in accordance with fitting instructions and local regulations.

Where the appliance is not connected to the mains electricity supply by a plug, an omni polar cutout device (with a contacts gap of at least 3 mm) must be fitted on the supply side of the connection to meet safety requirements.

- ⊗ When power is connected, the electronics of the oven are initialised; this neutralizes the lighting for a few seconds. The electric cable (H05 RR-F or H05 VV-F, Min. 1.5m, 1.5~2.5mm²) must be long enough for it to be connected to the built-in oven standing on the floor in front of its unit.

Open the back cover of the oven at the bottom (using a flat-bladed screwdriver) and completely unscrew the connection screw and the cable clamp before fitting conducting wires into the appropriate terminals.

The earth wire must be connected to the (\perp) terminal of the oven.

If the oven is connected to the power supply by a plug, this must remain accessible once the oven has been fitted.

We cannot accept any liability in the event of an accident resulting from non-existent or faulty earthing.

6

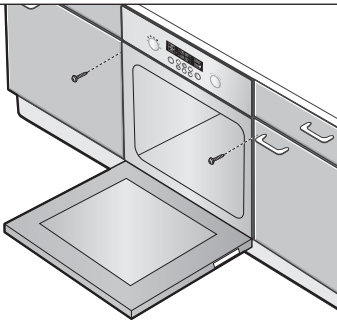

7

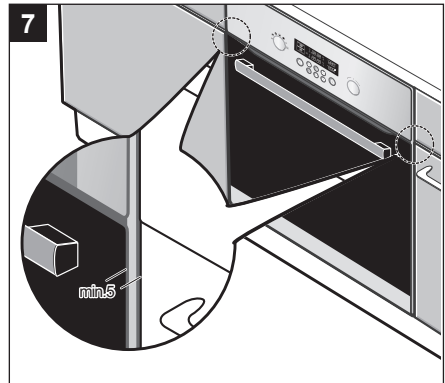

Installing the Oven (Continued)

EN

Installing into a high cabinet

- Observe minimum clearance requirements.
- The oven should be slid into place at the proper angle of alignment.

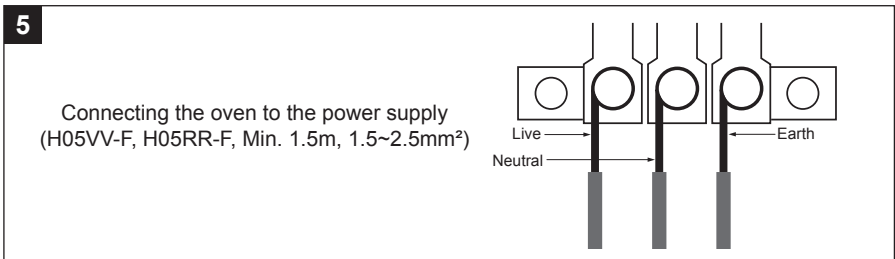
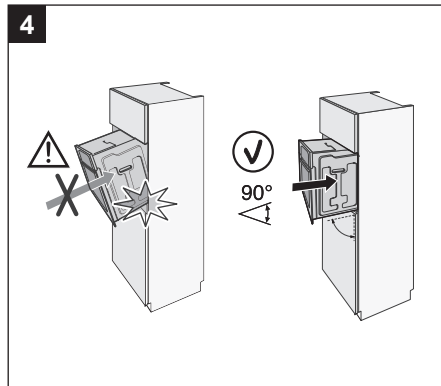
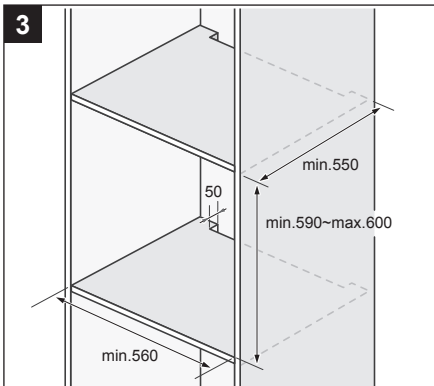
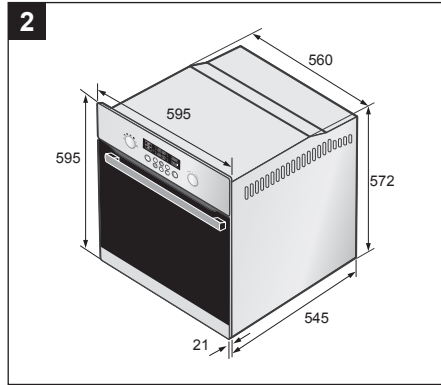
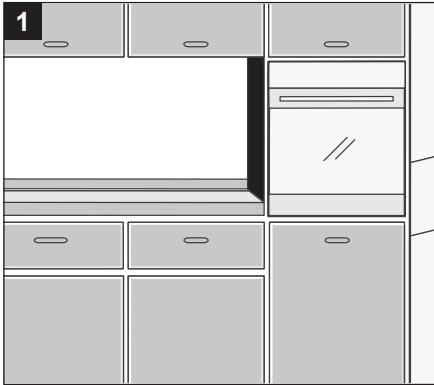

Parts and Features

Oven

EN

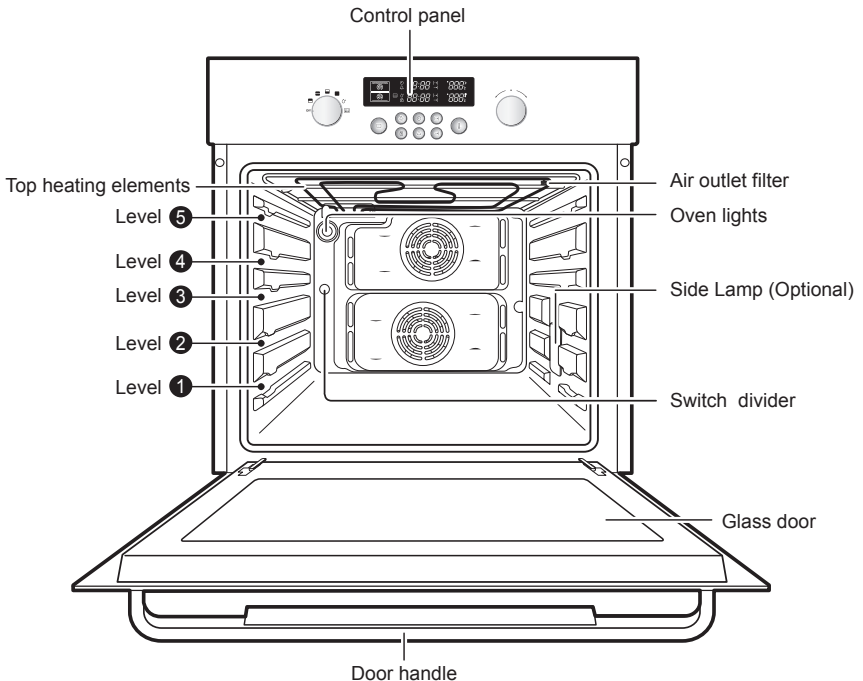

Shelf levels are numbered from the bottom up.

Levels 4 and 5 are used mainly for the grill function.

Please refer to the cooking guides provided throughout this manual to determine appropriate shelf levels for your dishes.

Parts and Features (Continued)

EN

Oven controls

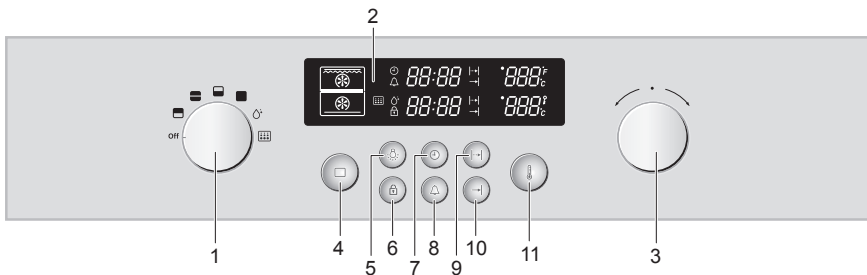

- | | |
|-----------------------------|-------------------------|
| 1. Divider Select Knob | 7. Clock Button |
| 2. Window Display | 8. Kitchen Timer Button |
| 3. Time / Temp Control Knob | 9. Cook Time Button |
| 4. Oven Button | 10. End Time Button |
| 5. Lamp Button | 11. Temperature Button |
| 6. Child Lock Button | |

☒ The **Divider Select Knob** and the **Time / Temp Control Knob** are pop - up knobs. Simply push to turn.

Special features

The oven comes equipped with the following special features.

- **Divider modes:** When the divider inserted, the appliance's divider facility enables independent cooking in two separated partitions, enhancing energy efficiency and convenience for use.
- **Steam cleaning:** The oven's self-cleaning function uses the power of steam to cut through grease and grime to clean the oven interior safely.

Parts and Features (Continued)

Accessories

The following accessories are provided with your oven.

EN

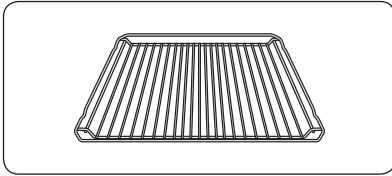

1 Wire grill, for dishes, cake tins, roasting and grilling trays.

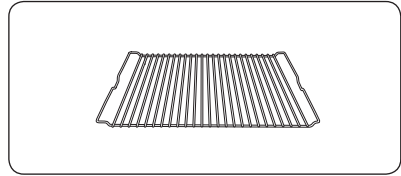

2 Wire roast (Optional BT62 Series), for roasting.

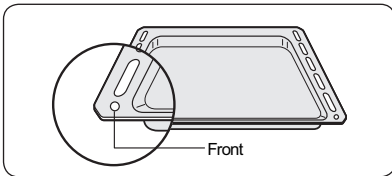

3 Baking tray, for cakes and biscuits.

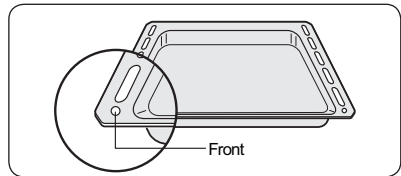

4 Deep pan, for roasting or collecting meat juices or fat drippings.

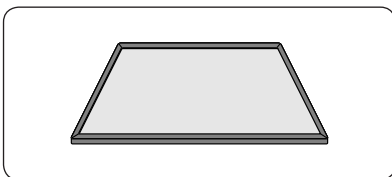

5 Divider, for the upper, lower and twin modes. Use inserted in level 3. There is a divider-sensing switch on the rear wall of the cooking compartment. Insert into the back completely.

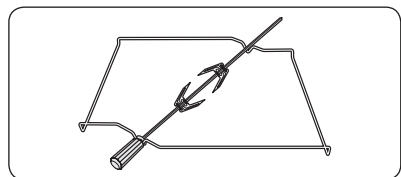

6 Rotisserie spit (Optional BT62 Series) comprises a spit, 2 prongs, a removable handle and a cradle, which fits into the 3rd shelf from the bottom. To use the rotisserie, fit the spit into the hole in the rear wall of the oven's interior. Place the deep pan on level 1 when using the spit.

Parts and Features (Continued)

EN

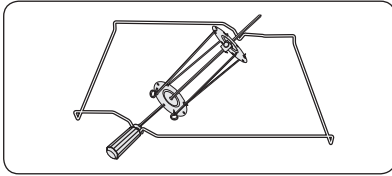

7 Rotisserie spit and Shasilik. (BT62FQBFST / BT62FQFST)

To USE IT :

- Place the deep pan (no trivet) at level 1 to collect the cooking juices or on the bottom of the oven if the piece of meat to be roasted is too big.
- Slide one of the forks onto the spit; put the piece of meat to be roasted onto the spit;
- Parboiled potatoes and vegetables can be placed around the edge of the deep pan to roast at the same time.
- Place the cradle on the middle shelf and position with the “v” shape at the front.
- To help insert the spit, the handle can be screwed onto the blunt end.
- Rest the spit onto the cradle with the pointed end towards the back and gently push until the tip of the spit enters the turning mechanism at the back of the oven. The blunt end of the spit must rest on the “v” shape. (The spit has two lugs which should be nearest to the oven door so to stop the spit going forward, the lugs also act as a grip for the handle.)
- Before cooking unscrew the handle. After cooking screw the handle back on to help remove the spit from the cradle.

WARNING

All accessory parts and unsuitable accessories for self cleaning should be removed for pyrolytic cleaning.

Parts and Features (Continued)

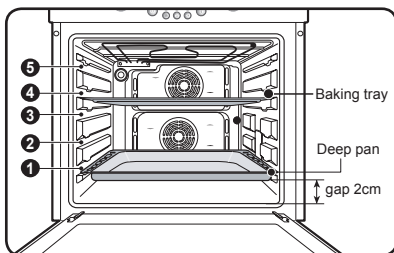

The baking tray, deep pan and wire grill should be inserted correctly into the side runners. When taking out the cooked foods from the oven, be careful of hot utensils and surfaces.

Example

Level 1: Deep pan
Level 4: Baking tray

- ☒ When using the deep pan or the baking tray to collect drippings from cooking foods, ensure that the pan or tray is properly placed in the side runners. Allowing these accessories to contact the bottom surface of the oven can damage the enamel of the surface. Trays and pans placed on level 1 should clear the bottom surface of the oven by at least 2 cm.

Using the accessories

Divider, wire grill, baking tray and deep pan

Positioning the divider

Insert the divider into level 3 of the oven.

Positioning the wire grill

Insert the wire grill at any desired level.

Positioning the baking tray or deep pan

Insert the baking tray and/or the deep pan at any desired level.

WARNING

To cook in the lower, upper or twin divider modes, you must insert the divider.

Safety shutoff

- If a cooking time is not entered, the oven will shut itself off after the lengths of time indicated below.

Shutoff times for various temperature settings

Under 105 °C	16 hours
From 105 °C to 240 °C	8 hours
From 245 °C to 300 °C	4 hours

- This oven's electrical circuitry features a thermal shutoff system. If the oven heats to abnormally high temperatures, the system will shut off the power supply to the heating elements for a period of time.

Cooling fan

During cooking, it is normal for the vent to release hot air from the front of the oven.

- The cooling fan will also continue to operate after the oven has been in use. It will turn off when the internal cabinet temperature has dropped to 60 °C or after 22 minutes.

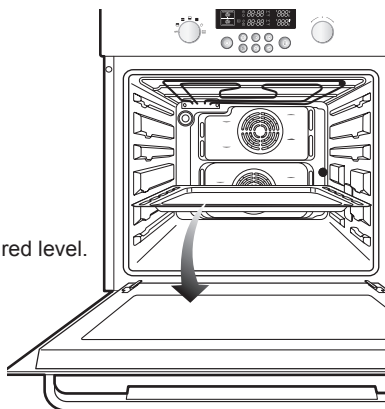

Before You Begin

EN

Setting the clock

When power is first supplied to the oven, the display on the control panel will light briefly. After 3 seconds, an icon of a clock and 12:00 will begin blinking in the display. The oven cannot be operated until the clock is set.

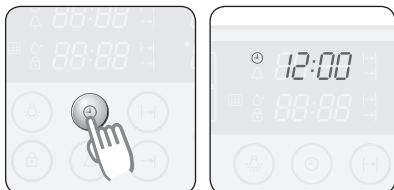

- 1** The oven is inoperable until the clock has been set. "⌚" and "12:00" will blink in the display when power is first supplied to the appliance. Press the **Clock Button**. The "⌚" and "12:" will blink.

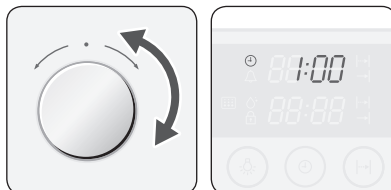

- 2** Turn the **Time / Temp Control Knob** to set the hour of the day.
Example To set 1:30
Wait for about 10 seconds. The clock stops blinking and shows the set hour.

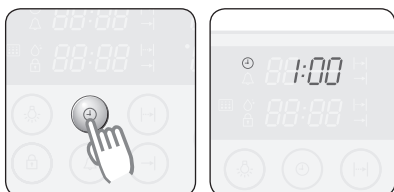

- 3** Press the **Clock Button**. The "⌚" and ":00" will blink.



- 4** Turn the **Time / Temp Control Knob** to set the minute of the time. "⌚" will blink.

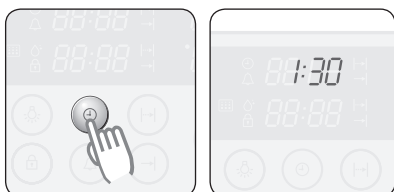

- 5** Press the **Clock Button** to finish setting the clock or wait for about 10 seconds. "⌚" will disappear and "30" will stop blinking. The display shows the time of day. The appliance is now ready to use.

Before You Begin (Continued)

EN

Initial cleaning

Clean the oven thoroughly before using for the first time.

- Do not use sharp or abrasive cleaning materials. These could damage the oven surface. For ovens with enamel fronts, use commercially available cleaning agents.

To clean the oven

1. Open the door. The oven light comes on.
2. Clean all oven trays, accessories and side runners with warm water or washing - up liquid and polish dry with a soft clean cloth.
3. Wash the oven interior in the same way.
4. Wipe the front of the appliance with a damp cloth.

Check that the clock is set correctly. Remove accessories and operate the oven at the convection setting at 200 °C for 1 hour before using. There will be a distinctive odor; this is normal, but ensure your kitchen is well ventilated during this conditioning period.

Oven Use

EN

Setting the divider mode

For upper, twin and lower modes, insert the divider at the "OFF" position of **Divider Select Knob**. For single mode, remove the divider at the "OFF" position. And then turn the **Divider Select Knob** to select the mode you want. For further details, see the table below.

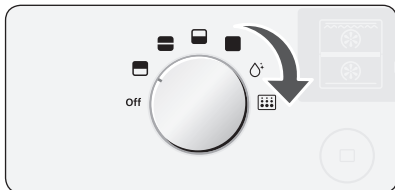

1 Turn the **Divider Select Knob** to select the desired partition.

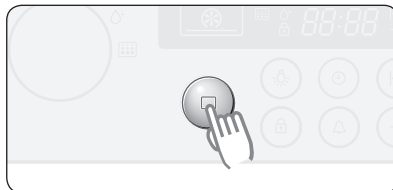

2 Press the **Oven Button**.



3 Turn the **Time / Temp Control Knob** to select the desired oven function. If 3 seconds have elapsed and there are no further adjustments, the oven will begin automatically in the selected mode and function.

Divider Mode	Marking	Oven Function	Insert Divider	Usage Information
Off	Off			
Upper Mode		1. Convection 2. Top Heat + Convection 3. Large Grill	Yes	This mode saves energy and time when cooking small amounts of food.
Twin Mode		Both Upper and Lower Partition Function	Yes	You can cook two dishes at two different temperatures at the same time.
Lower Mode		1. Convection 2. Bottom Heat + Convection	Yes	This mode saves energy and time when cooking small amounts of food.
Single Mode		1. Convection 2. Top Heat + Convection 3. Conventional 4. Large Grill 5. Small Grill 6. Bottom Heat + Convection	No	
Steam Clean Mode			No	
Self Clean Mode		1. P1 2. P2 3. P3	No	

Oven Use (Continued)

EN

Upper mode

Only the upper heating element operates. The divider should be inserted.

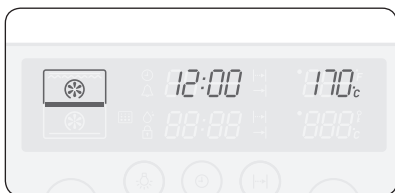

Convection

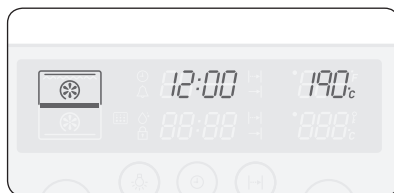

Top Heat + Convection

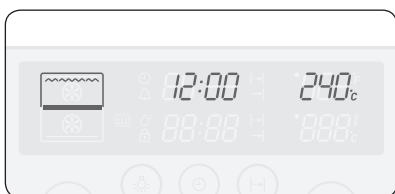

Large Grill

Lower mode

Only the lower heating element operates. The divider should be inserted.

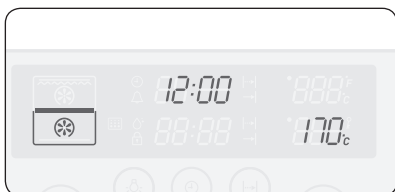

Convection

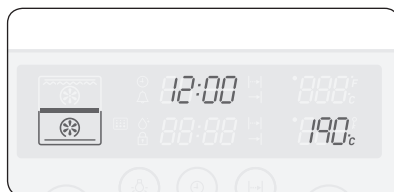

Bottom Heat + Convection

Oven Use (Continued)

EN

Twin mode

The upper and lower modes operate at the same time. It is possible to set which mode activates first. When one of the dishes has finished cooking in twin mode and you would like to change the cooking time or temperature of the other partition, turn the **Divider Select Knob** to select the mode (upper or lower) that you would like to continue operating. Divider should be inserted.

Twin mode 1: The upper mode begins operating first. If the **Oven Button** is pressed or if 15 seconds elapse after the upper mode is set and there has been no further adjustment, the oven begins the lower mode.

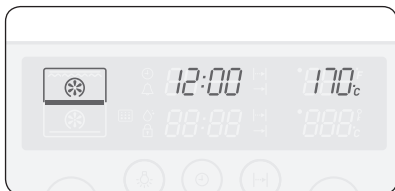

Convection

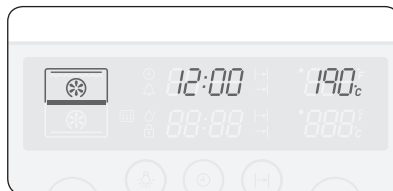

Top Heat + Convection

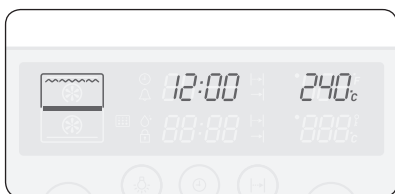

Large Grill

Twin mode 2: As the upper mode starts, if the **Oven Button** is pressed or if 15 seconds elapse and there has been no further adjustment, the oven moves to the lower mode. The upper and lower modes operate at the same time.

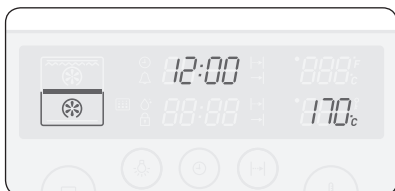

Convection

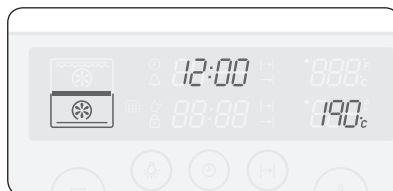

Bottom Heat + Convection

Oven Use (Continued)

EN

Single mode



Convection



Top Heat + Convection

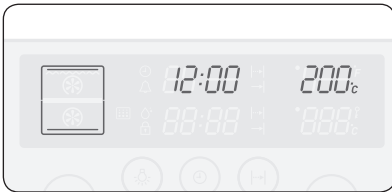

Conventional

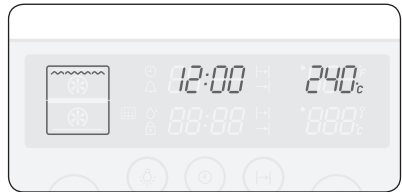

Large Grill

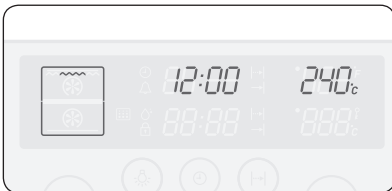

Small Grill

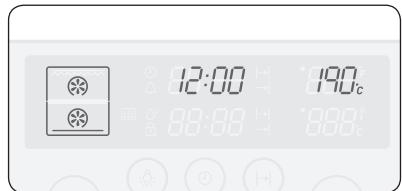

Bottom Heat + Convection

Oven Use (Continued)

EN

Setting the oven temperature

In single, upper and lower modes

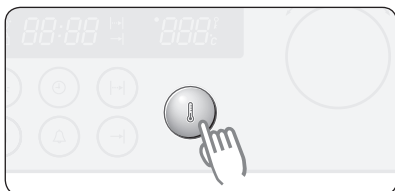

1 Press the **Temperature Button**.

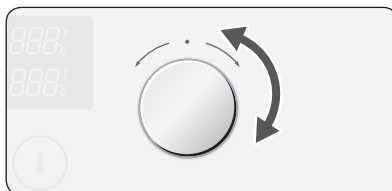

2 Turn the **Time / Temp Control Knob** to adjust the temperature in increments of 5 °C.

Single Mode (Large & Small Grill)	40 °C – 250 °C (40 °C – 300 °C)
Upper Mode	40 °C – 250 °C
Lower Mode	40 °C – 250 °C



The temperature may be adjusted during cooking.

In the oven mode settings, the top and bottom heating elements cycle on and off in intervals through the cooking process to regulate and maintain the temperature.

In twin mode

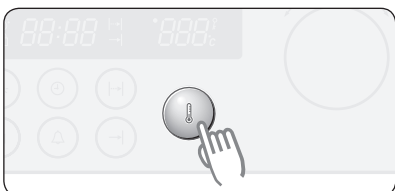

1 Press the **Temperature Button** (upper mode).
Press the **Temperature Button** twice (lower mode).

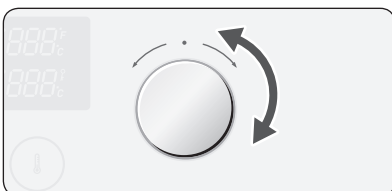

2 Turn the **Time / Temp Control Knob** to adjust the temperature in increments of 5 °C.

	BT62 Series	BT620 Series
Upper Mode (Large Grill)	160°C-250°C 200°C-250°C	170°C-250°C 200°C-250°C
Lower Mode	160°C-250°C	170°C-250°C



The temperature may be adjusted during cooking.

Oven Use (Continued)

EN

Switching the oven off



To switch the oven off, turn the **Divider Select Knob** to the **"Off"** position.

End time

You can set the end time during cooking.

In single, upper and lower modes



- 1** Press the **End Time Button**.
Example Current time is 12:00



- 2** Turn the **Time / Temp Control Knob** to set the desired end time.



- 3** Press the **End Time Button**.
The oven operates with the selected end time automatically unless the **End Time Button** is pressed within 5 seconds.

- ☒ During cooking, you can adjust the previously set end time with the **Time / Temp Control Knob** for better results.

Oven Use (Continued)

EN

In twin mode

End times for the upper and lower modes can be selected using the **End Time Button** and the **Time / Temp Control Knob**.

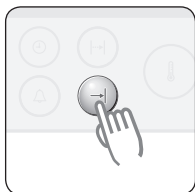

- 1** Press the **End Time Button** twice (lower mode).

Example Current time is 12:00

- 2** Turn the **Time / Temp Control Knob** to set the desired end time.



- 3** Press the **End Time Button**.
The oven operates with the selected end time unless the **End Time Button** is pressed within 5 seconds.

- ✉ During cooking, you can adjust the previously set end time with the **Time / Temp Control Knob** for better results.

Oven Use (Continued)

EN

Cook time

You can set the cook time during cooking.

In single, upper and lower modes

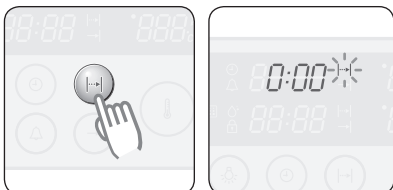

1 Press the **Cook Time Button**.



2 Turn the **Time / Temp Control Knob** to set the desired cook time.

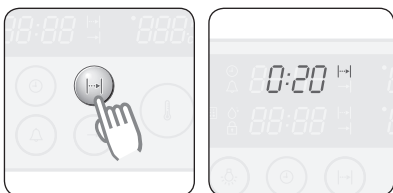

3 Press the **Cook Time Button**.
The oven operates with the selected cook time unless the **Cook Time Button** is pressed within 5 seconds.

- ✉ During cooking, you can adjust the previously set cook time with the **Time / Temp Control Knob** for better results.

Oven Use (Continued)

EN

In twin mode

Cook times for the upper and lower modes can be selected by using the **Cook Time Button** and the **Time / Temp Control Knob**.

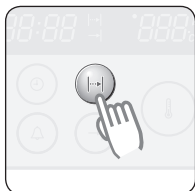

- 1** Press the **Cook Time Button** twice (lower mode).



- 2** Turn the **Time / Temp Control Knob** to set the desired cook time.



- 3** Press the **Cook Time Button**. The oven operates with the selected cook time unless the **Cook Time Button** is pressed within 5 seconds.

-  During cooking, you can adjust the previously set cook time with the **Time / Temp Control Knob** for better results.

Oven Use (Continued)

EN

Delayed start

Case 1 - Cook time is entered first

If the end time is entered after the cook time has already been set, the cook time and the end time are calculated and if necessary the oven sets a delayed start point.



1 Press the **End Time Button**.

Example

Current time is 3:00 and the desired cook time is 5 hours.

2 Turn the **Time/Temp Control Knob** to set the end time.

Example

You want to cook for 5 hours and finish at 8:30.

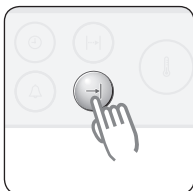

3 Press the **End Time Button**. A “” symbol appears until the delayed start point.

Oven Use (Continued)

EN

Case 2 - End time is entered first

If the cook time is entered after the end time has already been set, the cook time and the end time are calculated and if necessary the oven sets a delayed start point.



1 Press the **Cook Time Button**.

Example

Current time is 3:00 and the desired end time is 5:00.

2 Turn the **Time / Temp Control Knob** to set the cook time.

Example

You want to cook for 1 hour and 30 minutes and end by 5:00.

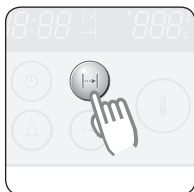



3 Press the **Cook Time Button**. A "C C C C" symbol appears until the delayed start point.

Oven Use (Continued)

EN

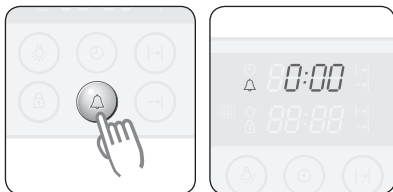
Kitchen timer



- 1** Press the **Kitchen Timer Button** once.
“” flashes.



- 2** Turn the **Time / Temp Control Knob** to set the desired time.

Example 5 minutes



- 3** Press the **Kitchen Timer Button** to start the kitchen timer. When the set time has elapsed, an audible signal sounds.

 Press and hold the **Kitchen Timer Button** for 2 seconds to cancel the timer.

Oven lamp on/off

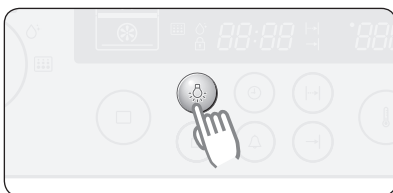

- 1** Press the **Lamp Button**.

BT62 Series	1st	Upper and Lower
	2nd	Upper
	3rd	Lower
	4th	Off
BT620 Series	1st	On
	2nd	Off

 Lamp turns on and off in the indicated order regardless of operation.

 The lamp automatically turns off after 2 minutes.

Oven Use (Continued)

EN

Child safety function

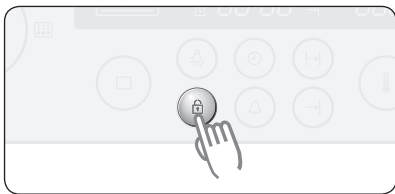

- 1 Press the **Child Lock Buttons** hold for 3 seconds. (🔒) will appear in the display field.

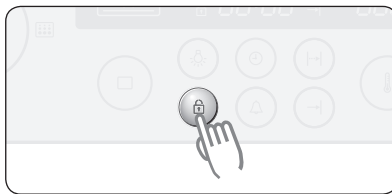

- 2 Press the **Child Lock Buttons** hold for 3 seconds again to unlock.

- ☒ When locked, all buttons and knobs except the **Divider Select Knob** and the unlock button will not operate. The lock is available whether or not the oven is in operation.

Switching the beeper off

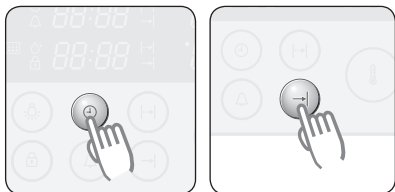

- 1 To turn the beeper off, press the **Clock and End Time Buttons** at the same time and hold for 3 seconds.

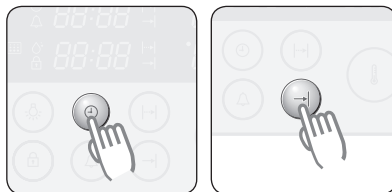

- 2 To turn the beeper back on, press the **Clock and End Time Buttons** again at the same time and hold for 3 seconds.

Oven Use (Continued)

EN

Oven functions

The features of this oven include the following functions

Oven Modes

The following table represents the various oven modes and settings of your oven. Use the cooking guide tables for these modes in the following pages as guidelines for cooking.



Conventional

Food is heated by top and bottom heating elements. This setting is suitable for baking and roasting.



Top Heat + Convection

We recommend this mode when roasting meat. The top heating element is in operation and the fans operate to circulate the hot air coming from top and back wall heating element.



Convection

Food is heated by the hot air from the heating element in the back and circulated by two fans. This setting provides uniform heating and is ideal for frozen convenience food as well as cake and croissants. This mode can be used for baking on two levels.



Large Grill

Food is heated by the top heating elements. We recommend this mode for grilling steaks and sausages as well as cheese toasts.



Small Grill

This mode is ideal for grilling small amounts of foods, such as baguettes, cheese or fish fillets. Place the food in the middle of the wire grill, as only the smaller heating element in the centre is operating.



Bottom Heat + Convection

The bottom heating element and back wall heating element provide hot air which is circulated by the fans. This mode is ideal for baking food such as quiches, pizza, bread and cheesecakes.

Oven Use (Continued)

EN

1. Conventional

Suggested temperature: 200 °C

The conventional function is ideal for baking and roasting foods arranged on one rack. Both the top and bottom heating elements operate to maintain the oven temperature.

We recommend to preheat the oven in conventional mode.

Food Item	Shelf Level	Accessory	Temperature (°C)	Time (min)
Frozen Lasagne (500-1000g)	3	Wire grill	180 - 200	40-50
Whole Fish (e.g. Dorade) (300-1000g) 3-4 cut on each side DROP OIL	3	Wire roast + Deep Pan	240	15-20
Fish filets (500-1000g) 3-4 cut on each side DROP OIL	3	Baking tray	200	13-20
Frozen cutlets (350-1000g) minced meat & with ham, cheese or mushroom filing DROP OIL	3	Baking tray	200	25-35
Frozen cutlets from minced, carrot, beetroot or potato (350-1000g) DROP OIL	3	Baking tray	200	20-30
Pork on bone cutlets (500-1000g) DROP OIL, ADD SALT & PEPPER	3 / 2	Wire roast / Deep pan	200	40-50
Baked potato (cut in half) (500-1000g)	3	Baking tray	180-200	30-45
Frozen Meat roll with mushrooms filing (500-1000g) DROP OIL	3	Baking tray	180-200	40-50
Sponge Cake (250-500g)	2	Wire grill	160 - 180	20 - 30
Marble Cake (500-1000g)	2	Wire grill	170 - 190	40 - 50
Yeast Cake on Tray with fruit & crumbles topping (1000-1500g)	2	Baking tray	160 - 180	25 - 35
Muffins (500-800 g)	2	Wire grill	190 - 200	25 - 30

Oven Use (Continued)

2. Top Heat + Convection

Suggested temperature: 190 °C

The top heating element is in operation and the fan operates to constantly circulate the hot air.

We recommend to preheat the oven with Top Heat + Convection mode.

Food Item	Shelf Level	Accessory	Temperature (°C)	Time (min)
Pork on bone (1000g) BRUSH WITH OIL&SPICES	3	Wire roast + Deep pan	180 - 200	50-65
Pork shoulder in foil (1000-1500g) MARINATE	2	Baking tray	180 - 230	80 - 120
Whole chicken (800-1300g) BRUSH WITH OIL & SPICES	2	Wire roast + Deep Pan	190 - 200	45 - 65
Meat or fish steaks (400-800g) DROP OIL, ADD SALT & PEPPER	3	Wire roast + Deep pan	180 - 200	15 - 35
Chicken Pieces (500-1000g) BRUSH WITH OIL&SPICES	4	Wire roast + Deep pan	200 - 220	25 - 35
Roast Fish (500g-1000g) use ovenproof dish BRUSH WITH OIL	2	Wire grill	180 - 200	30 - 40
Roast Beef (800-1200g) BRUSH WITH OIL&SPICES	2	Wire roast + Deep pan Add 1 cup water	200 - 220	45 - 60
Duck Breast (300-500g)	4	Wire roast + Deep pan Add 1 cup water	180 - 200	25 - 35

Oven Use (Continued)

EN

3. Convection

Suggested temperature: 170 °C

This function bakes foods placed on up to three shelves and is also appropriate for roasting. Cooking is achieved by the heating element on the rear wall and the fan distributes the heat.

We recommend to preheat the oven in convection mode.

Food Item	Shelf Level	Accessory	Temperature (°C)	Time (min)
Lamb rack (350-700g) , BRUSH WITH OIL & SPICES	3	Wire roast + Deep pan	190 - 200	40-50
Baked Bananas (3-5 pcs), cut with knife on top, add10-15g chocolate, 5-10g nuts into cuts, drop sugar water, wrap in aluminium foil.	3	Wire grill	220 - 240	15-25
Baked apples 5-8pcs each 150-200g Take out the hearts, add raisins and jam. Use ovenproof dish.	3	Wire grill	200-220	15-25
Cutlets from minced meat (300-600g) DROP OIL	3	Baking tray	190 - 200	18-25
Minced Meat roll with filling ,Russian style' (500g-1000g) BRUSH WITH OIL	3	Baking tray	180-200	50-65
Frozen Croquettes (500-1000g)	2	Baking tray	180 - 200	25 - 35
Frozen Oven Chips (300-700g)	2	Baking tray	180 - 200	20 - 30
Frozen Pizza (300-1000g)	2	Wire grill	200 - 220	15 - 25
Apple & Almond Cake (500-1000 g)	2	Wire grill	170 - 190	35 - 45
Fresh Croissant (200-400g) (ready-dough)	3	Baking tray	180 - 200	15 - 25

Oven Use (Continued)

4. Large Grill

Suggested temperature: 240 °C

The large grill function grills large quantities of flat foods, such as steaks, schnitzels and fish. It is also suitable for toasting. Both the top heating element and the grill are on in this mode.

We recommend to preheat the oven using Large Grill mode.

Food Item	Shelf Level	Accessory	Temperature (°C)	Time (min)
Sausages (thin) 5-10pcs	4	Wire roast + Deep pan	220	5 - 8 turnover 5 - 8
Sausages (thin) 8-12pcs	4	Wire roast + Deep pan	220	4 - 6 turnover 4 - 6
Toasts 5-10pcs	5	Wire grill	240	1 - 2 turnover 1 - 2
Cheese Toasts 4-6 pcs	4	Wire roast + Baking tray	200	4 - 8
Frozen Pancakes with filling 'Russian Style' (200- 500g)	3	Baking tray	200	20 - 30
Beef Steaks (400-800 g)	4	Wire roast + Deep pan	240	8 - 10 turnover 5-7

Oven Use (Continued)

EN

5. Small Grill

Suggested temperature: 240 °C

This setting is for grilling smaller amounts of flat foods, such as steaks, schnitzels, fish and toast, placed in the middle of the tray. Only the top element is in operation.

We recommend to preheat the oven using Small Grill mode.

Put food in the centre of accessory.

Food Item	Shelf Level	Accessory	Temperature (°C)	Time (min)
Frozen Oven Camembert (2 – 4 each 75g) PUT IN COLD OVEN (before preheat)	3	Wire grill	200	10-12
Frozen Baguettes with topping (Tomato-Mozzarella or Ham & Cheese)	3	Wire roast + Baking tray	200	15-20
Frozen Fish fingers (300-700g) PUT IN COLD OVEN , (before preheat) DROP OIL	3	Wire roast + Baking tray	200	15-25
Frozen Fish burger (300- 600g) PUT IN COLD OVEN, DROP OIL	3	Baking tray	180-200	20-35
Frozen Pizza (300-500g) PUT IN COLD OVEN (before preheat)	3	Wire roast + Baking tray	180-200	23-30

Oven Use (Continued)

6. Bottom Heat + Convection

Suggested temperature: 190 °C

The Bottom Heat + Convection mode is for recipes calling for a moist topping and a crisp base, as with foods like pizzas, quiches lorraine, German-style open fruitcakes and cheese-cakes.

We recommend to preheat the oven in Bottom Heat + Convection mode.

Food Item	Shelf Level	Accessory	Temperature (°C)	Time (min)
Yeast dough pie with apple frozen (350-700g)	3	Wire grill	180-200	15-20
Puff pastry small pies with filling frozen (300-600g) BRUSH EGG YOLK, PUT IN COLD OVEN (before preheat),	3	Baking tray	180-200	20 - 25
Meat balls in sauce (250-500g) use ovenproof dish	3	Wire grill	180-200	25-35
Puff pastry fans (500-1000g) BRUSH EGG YOLK	3	Baking tray	180	15-23
Cannelloni in sauce (250-500g) use ovenproof dish	3	Wire grill	180	22-30
Yeast dough pies with filling (600-1000g) BRUSH EGG YOLK	3	Baking tray	180-200	20-30
Homemade Pizza (500-1000g)	2	Baking tray	200 - 220	15 - 25
Homemade Bread (700-900g)	2	Wire grill	170 - 180	45 - 55

Oven Use (Continued)

EN

7. Twin Mode

Using twin mode you can cook two different food items in your oven. When cooking in upper and lower cavity you can use different temperatures, cooking modes and cooking times. For example, you can grill steaks and bake gratin simultaneously. Using the divider, you can cook gratin in the lower and steaks in the upper part of the oven.

Always insert divider into shelf level 3 before you start cooking.

Suggest 1: Cooking at different temperatures

Cavity	Food Item	Shelf Level	Cooking Mode	Temperature (°C)	Accessory	Time (min)
UPPER	Frozen Pizza (300-400g)	4	Convection	200-220	Wire grill	15-25
LOWER	Marble Cake (500-700g)	1	Convection	170 - 180	Baking Tray	50-60

Notice: Put food in cold oven

Suggest 2: Cooking at different cooking modes

Cavity	Food Item	Shelf Level	Cooking Mode	Temperature (°C)	Accessory	Time (min)
UPPER	Chicken Pieces (400-600g)	4	Top Heat + Convection	200-220	Wire Roast + Deep Pan	25-35
LOWER	Potato Gratin (500-1000g)	1	Convection	170-180	Wire Grill	30-40

Notice: Put food in cold oven

Oven Use (Continued)

EN

Test dishes

According to standard EN 60350

1. Baking

The recommendations for baking refer to preheated oven.

Type of Food	Dish & Notes	Shelf level	Cooking Mode	Temp. °C	Cooking time min
Small Cakes	Baking tray	3	Conventional	160-180	15-25
	Deep pan + Baking tray	1+4	Convection	150-170	20-30
Fatless Sponge Cake	Baking tin on Wire grill (Dark coated, ø 26 cm)	2	Conventional	160-180	20-30
Apple Pie	Wire grill + Baking tray + 2 Springform cake tins (Dark coated, ø 20 cm)	1+3	Convection	170-190	80-100
	Wire grill + 2 Springform cake tins (Dark coated, ø 20 cm)	1 Placed diagonally	Conventional	170-190	70-80

2. Grilling

Preheat the empty oven for 5 minutes using Large Grill function.

Use this function with the maximum temperature setting of 300°C.

Type of Food	Dish & Notes	Shelf level	Cooking Mode	Temp. °C	Cooking time min
White Bread Toasts	Wire grill	5	Large Grill	300	1 st 1-2 2 nd 1-1 1/2
Beef Burgers	Wire Roast + Deep pan (to catch drippings)	4	Large Grill	300	1 st 7-10 2 nd 6-9

Cleaning and Care

EN

Self cleaning

This mode for cleaning the oven automatically.

This mode burns the leftover grease in the oven so that it can be wiped out when the oven cools down. During the Self Cleaning (pyrolytic self-cleaning), oven door is locked automatically.

Door locking (\mathcal{L})	When the oven temperature heats up to 300°C , the door will be locked automatically for safety.
Unlocking	When the oven temperature is falls below 260°C, the door will be unlocked automatically.

WARNING

- During this process the oven becomes very hot.
- Children must be kept at a safe distance.

Attention

Before carrying out the self cleaning function, all accessory parts should be taken out of the oven.

Remove any large pieces of dirt by hand beforehand.

Because thick food residue, grease and meat juices are flammable, a fire may happen in the oven during the Self Cleaning.



- 1** Turn the **Divider Select Knob** to self cleaning mode.

- 2** Turn the **Time / Temp Control Knob** to level 1,2 or 3 according to the dirt level of oven. If 5 seconds have elapsed and there are no further adjustments, the oven will begin automatically in the selected level.

Level	Duration
P1(Low)	approx 120 minutes
P2(Medium)	approx 150 minutes
P3(High)	approx 180 minutes

- 3** After the oven cools down, wipe the oven door and along the edges of the oven out with a damp cloth.

Cleaning and Care (continued)

EN

Steam cleaning

- 1 Remove all accessories from the oven.
- 2 Pour approximately 400 ml (3/4 pint) of water onto the bottom of the empty oven. Use normal water only, no distilled water.
- 3 Close the oven door.
Caution The steam cleaning system can be switched on only when the oven has cooled to room temperature completely. Allow the oven to cool completely if it does not work.



- 4 Turn the **Divider Select Knob** to steam clean mode.

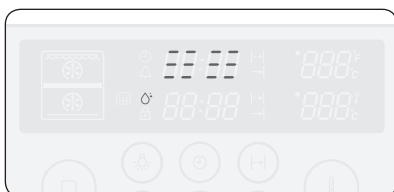
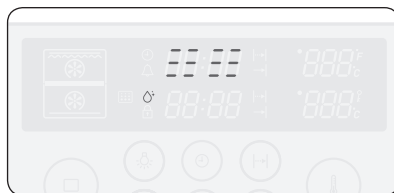

- 5 After an amount of time, the heater completes operating and its lamp remains on.

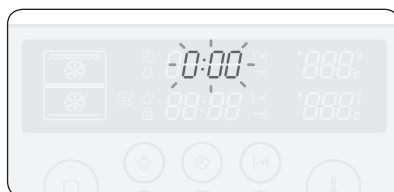

- 6 When the operation is complete, the display will blink and a beep indicates the end.



- 7 Turn the **Divider Select Knob** to "Off" to end the operation and clean the interior.

Cleaning and Care (continued)

EN

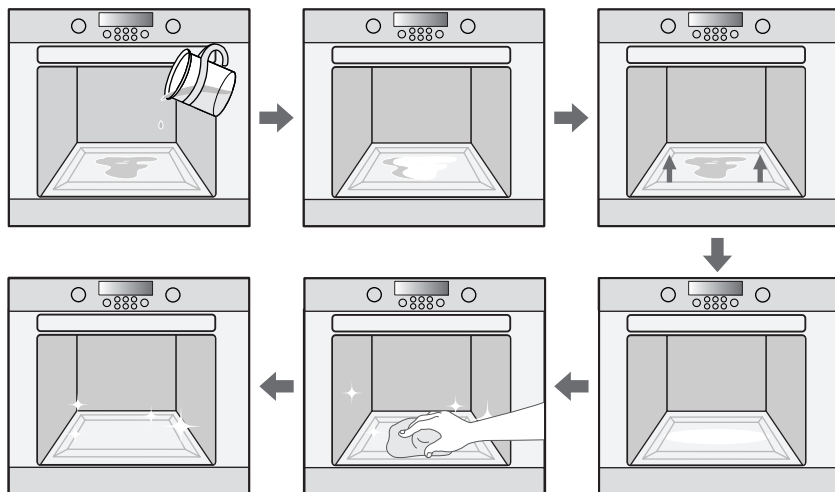

After deactivating the Steam Cleaning

Tips

- Take care when opening the door before the end of the steam cleaning procedure; the water on the bottom is hot.
- Never leave the residual water in the oven for any length of time, for example, overnight.
- Open the oven door and remove the remaining water with a sponge.
- Using a detergent - soaked sponge, a soft brush or a nylon scrubber, wipe the oven interior. Stubborn soil can be removed with a nylon scourer.
- Lime deposits may be removed with a cloth soaked in vinegar.
- Wipe clean with clear water and dry with a soft cloth (do not forget to wipe under the oven door seal).
- If the oven is heavily soiled, the procedure may be repeated after the oven has cooled.
- If the oven is heavily soiled with grease, for example, after roasting or grilling, it is recommended that you rub detergent into the stubborn soil before activating the oven cleaning function.
- After cleaning, leave the oven door ajar at a 15 ° angle to allow the interior enamel surface to dry thoroughly.

Cleaning and Care (continued)

EN

Rapid drying

1. Leave the oven door ajar at an angle of approximately 30°.
2. Turn the **Divider Select Knob** to single mode.
3. Press the **Oven Button**.
4. Turn the **Time / Temp Control Knob** to convection.
5. Set the cook time to about 5 minutes and the temperature to 50 °C.
6. Switch the oven off at the end of this period.

WARNING

Do not use high - pressure water cleaners or steam jet cleaners to clean the oven.

Oven exterior

- For cleaning both the interior and exterior of the oven, use a cloth and a mild cleaning agent or warm soapy water.
- Dry with kitchen paper or a dry towel.
- Do not use scourers, caustic cleaners or abrasive products.

Stainless steel oven fronts

- Do not use steel wool, scouring pads or abrasives. They may damage the finish.

Aluminium oven fronts

- Wipe the plate gently with a soft cloth or microfiber cloth and a mild window cleaning detergent.

WARNING

Make sure the oven is cool before cleaning.

Oven interior

- Do not hand - clean the door seal.
- Do not use coarse scouring pads or cleaning sponges.
- To avoid damaging the enameled oven surfaces, use commercially available oven cleaners.
- To remove stubborn soil, use a special oven cleaner.

Accessories

Wash all bakeware and accessories after each use and dry with a kitchen towel.
To clean easily, soak in warm soapy water for about 30 minutes.

Cleaning and Care (Continued)

EN

Cleaning the oven door

For normal use, the oven door should not be removed but if removal is necessary, for example, for cleaning, follow these instructions. The oven door is heavy.

Removing the door

1. Flip open the clips at both hinges.

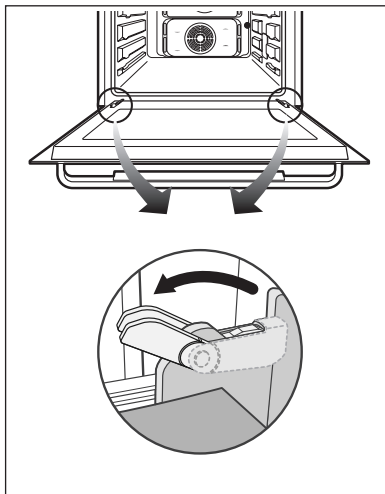

2. With both hands, grasp the sides of the oven door at its middle.
3. Rotate the door by approximately 70° until the hinges can be taken out completely from the hinge holes.

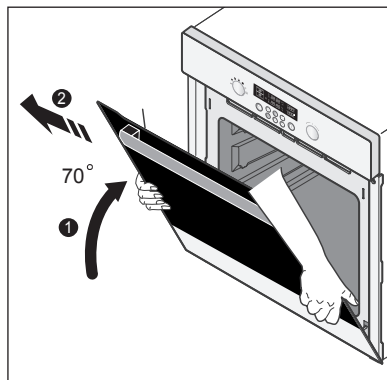

Cleaning and Care (Continued)

EN

Attaching the door

1. With the clips still flipped open, align the door hinges into the hinge holes.

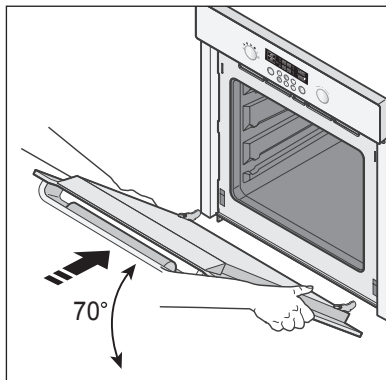

2. Rotate the door toward the horizontal line and flip the clips closed.

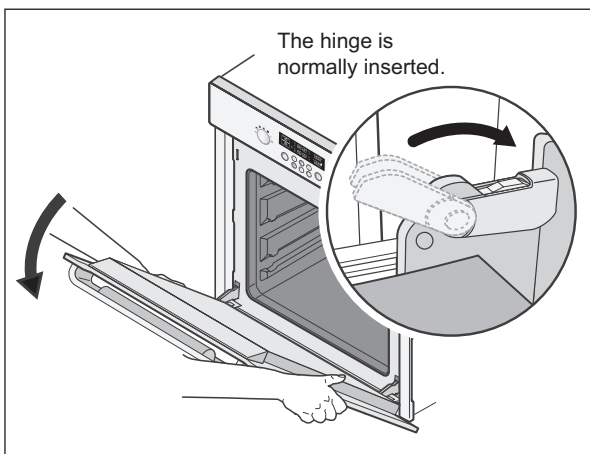
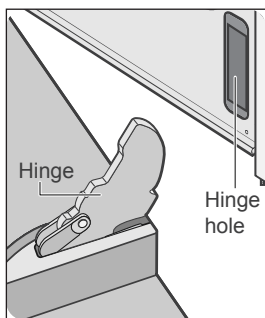

Cleaning and Care (Continued)

EN

Oven door glass

The oven door is equipped with three sheets of glass placed against each other. The inner & middle sheets can be removed for cleaning.

WARNING

- Whenever the door is separated from the oven, the clips should be flipped open.
- Do not use harsh abrasive cleaners or metal scrapers to clean the oven door; they can scratch the surface, which may cause the glass to shatter.
- When the door is mounted, removing some of the parts (the door glass or some other part) from the door may result in injury.

Attention

The glass may break if you use excessive force especially at the edges of the front sheet.

Disassembling the door

1. Remove the two screws on the left and right sides of the door.
2. Take off the door bracket.

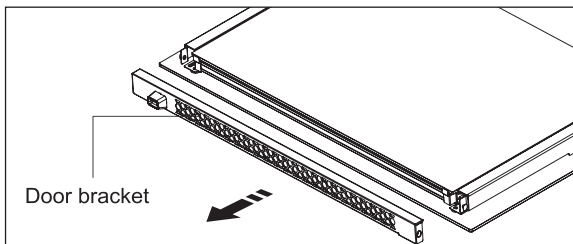
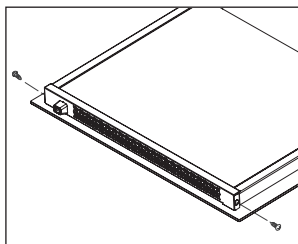

3. Detach the inner glass #1 from the door.

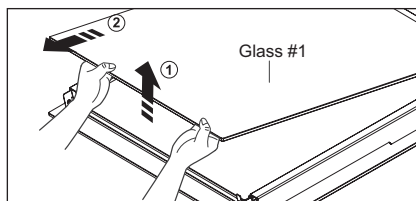

4. Detach the inner glass #2 and spring-brackets from the door.

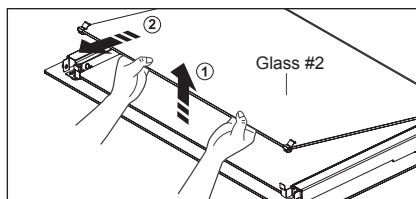

Cleaning and Care (Continued)

EN

5. Detach the glass #3 from the door

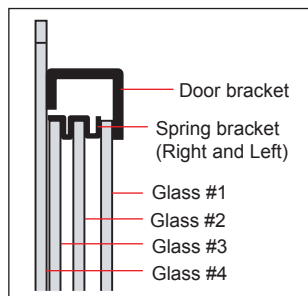
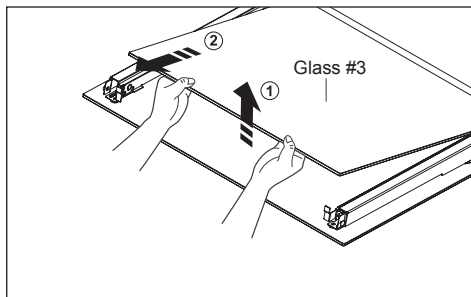

- ☒ Clean the sheets with warm water or washing-up liquid and polish dry with a soft clean cloth.

Assembling the door

1. Clean the glass and interior parts with warm soapy water.
 - ☒ Do not use abrasive cleaners or pan scourers. Use a sponge with liquid detergent or warm soapy water.
2. Attach the glass #3 into position.
3. Attach the two spring brackets at the top of glass #2 and place glass #2 into position.
4. Attach glass #1, the door bracket to the door.
5. Secure the two screws at both sides of the door.

Cleaning and Care (Continued)

EN

Changing the lamp



Danger of electric shock!

Before replacing the oven light bulb, take the following steps:

- Switch off the oven;
- Disconnect the oven from the mains supply; and
- Protect the oven light bulb and the glass cap by laying a cloth on the bottom of the oven.



You can buy a lamp at SAMSUNG service centre.

Replacing the rear oven lamp and cleaning the glass cap

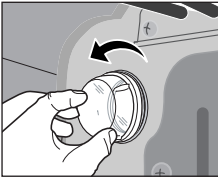

1. Take off the cap by turning counterclockwise.
2. Remove the metal rings and clean the glass cap.
3. If necessary, replace the halogen bulb with a 25 watt, 230 V, 300 °C heat - resistant halogen oven light bulb.

Tip

- Always use a cloth when handling a halogen bulb to avoid depositing oils from your fingers on to the surface of the bulb.

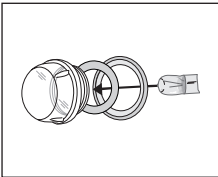

4. Fit the metal rings to the glass cap.
5. Replace the glass cap.

Replacing the oven side lamp and cleaning the glass cap (Optional BT62 Series)

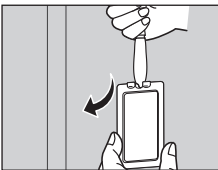

1. To remove the glass cover, hold the lower end with one hand, insert a flat sharp implement such as a table knife between the glass and the frame and pop out the cover.
2. If necessary, replace the halogen bulb with a 25 ~ 40 watt, 240 V, 300 °C heat - resistant halogen oven light bulb.

Tip

- Always use a cloth when handling a halogen bulb to avoid depositing oils from your fingers on to the surface of the bulb.



3. Replace the glass cover.

FAQs and Troubleshooting

What should I do if the oven doesn't heat up?

Check to see if one of the following actions resolves the issue:

- The oven may not be switched on. Switch the oven on.
- The clock may not be set. Set the clock (see section "Setting the clock").
- Check to see if the required settings have been applied.
- A household fuse may have blown or a circuit breaker may have tripped. Replace the fuses or reset the circuit. If this happens repeatedly, call an authorised electrician.

What should I do if, even though the oven function and temperature have been set, the oven does not heat up?

There may be problems with the internal electrical connections. Call your local service centre.

What should I do if an error code appears and the oven does not heat up?

There is a fault in the internal electrical circuit connection. Call your local service centre.

What should I do if the time display is blinking?

There was a power failure. Set the clock (see section "Setting the clock").

What should I do if the oven light doesn't illuminate?

The oven light is faulty. Replace the oven light bulb (see section "Changing the lamp").

What should I do if the oven's fan is running without having been set?

Following use, the oven's fan runs until the oven has cooled down. Call your local service centre if the fan continues to run after the oven has cooled down.

Warranty & Service (Continued)

EN

Error and Safety codes

Error and Safety codes	General Functions	Solution
E-2* ¹⁾	TEMP SENSOR ERROR	Call local SAMSUNG service centre.
S-01	SAFETY SHUTOFF Oven has continued operating at set temperature for prolonged time.	Turn oven off and remove food. Allow oven to cool before using again.
-SE-E-0* ¹⁾	An error of the oven may cause low performance and problems in safety. Stop using the oven immediately.	Call local Samsung service centre.
-dE-	PARTITION MISSING The usage of divider is not correct. Refer to the ' Setting the divider mode ' (14page).	For upper, twin and lower mode, divider should be inserted, and for single mode, divider should be eliminated.

1) * refers to all numbers or characters.

Technical data

EN

Power Source	240V ~ 50Hz
Volume (usable capacity)	65 L
Output Power	MAX 3,950 W
Weight Net Shipping	47 kg approx 52 kg approx
Dimensions (W x H x D) Outside Oven Cavity	595 x 595 x 566 mm 440 x 365 x 405 mm

Note



EN





QUESTIONS OR COMMENTS

COUNTRY	CALL	OR VISIT US ONLINE AT
AUSTRALIA	1300 362 603	www.samsung.com/au
New zealand	0800 SAMSUNG (0800-726-786)	www.samsung.com/nz
CHINA	800-810-5858 400-810-5858 010-6475 1880	www.samsung.com/cn
HONG KONG	3698-4698	www.samsung.com/hk
INDIA	3030 8282 1800 110011 1-800-3000-8282	www.samsung.com/in
INDONESIA	0800-112-8888	www.samsung.com/id
JAPAN	0120-327-527	www.samsung.com/jp
MALAYSIA	1800-88-9999	www.samsung.com/my
PHILIPPINES	1800-10-SAMSUNG(726-7864)	www.samsung.com/ph
SINGAPORE	1800-SAMSUNG(726-7864)	www.samsung.com/sg
THAILAND	1800-29-3232 02-689-3232	www.samsung.com/th
TAIWAN	0800-329-999	www.samsung.com/tw
VIETNAM	1 800 588 889	www.samsung.com/vn

Code No. DG68-00177N

Free Manuals Download Website

<http://myh66.com>

<http://usermanuals.us>

<http://www.somanuals.com>

<http://www.4manuals.cc>

<http://www.manual-lib.com>

<http://www.404manual.com>

<http://www.luxmanual.com>

<http://aubethermostatmanual.com>

Golf course search by state

<http://golfingnear.com>

Email search by domain

<http://emailbydomain.com>

Auto manuals search

<http://auto.somanuals.com>

TV manuals search

<http://tv.somanuals.com>