

SAMSUNG

**HCN479W
HCN529W
HCN559W
HCN5529W
HCN659W**

PROJECTION TELEVISION

SAMSUNG

ELECTRONICS

SERVICE DIVISION
400 Valley Road, Suite 201
Mount Arlington, NJ 07856
TEL : 1-800-SAMSUNG (1-800-726-7864)
www.samsungusa.com

**Owner's
Instructions**

BP68-00137A-00

Warning! Important Safety Instructions



CAUTION: TO REDUCE THE RISK OF ELECTRIC SHOCK, DO NOT REMOVE COVER (OR BACK). NO USER SERVICEABLE PARTS INSIDE. REFER SERVICING TO QUALIFIED SERVICE PERSONNEL.

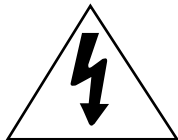

This symbol indicates high voltage is present inside. It is dangerous to make any kind of contact with any inside part of this product.



This symbol alerts you that important literature concerning operation and maintenance has been included with this product.

Note to CATV system installer: This reminder is provided to call CATV system installer's attention to Article 820-40 of the National Electrical Code (Section 54 of Canadian Electrical Code, Part I), that provides guidelines for proper grounding and, in particular, specifies that the cable ground shall be connected to the grounding system of the building as close to the point of cable entry as practical.

Caution: *FCC/CSA regulations state that any unauthorized changes or modifications to this equipment may void the user's authority to operate it.*

Caution: *To prevent electric shock, match the wide blade of plug to the wide slot, and fully insert the plug.*

Attention: *pour eviter les chocs electriques, introduire la lame le plus large de la fiche dans la borne correspondante de la prise et pousser jusqu'au fond.*

Important: One Federal Court has held that unauthorized recording of copyrighted TV programs is an infringement of U.S. copyright laws. Certain Canadian programs may also be copyrighted and any unauthorized recording in whole or in part may be in violation of these rights.

To prevent damage which may result in fire or electric shock hazard, do not expose this appliance to rain or moisture.

Thank You for Choosing Samsung

Thank you for choosing Samsung! Your new Samsung Projection TV represents the latest in television technology. We designed it with easy-to-use on-screen menus and closed captioning capabilities, making it one of the best products in its class. We are proud to offer you a product that will provide convenient, dependable service and enjoyment for years to come.

Important Safety Information

 Always be careful when using your TV receiver. To reduce the risk of fire, electrical shock, and other injuries, keep these safety precautions in mind when installing, using, and maintaining your machine.

- Read all safety and operating instructions before operating your TV.
- Keep the safety and operating instructions for future reference.
- Heed all warnings on the TV receiver and in the operating instructions.
- Follow all operating and use instructions.
- Unplug the TV receiver from the wall outlet before cleaning. Use a damp cloth; do not use liquid or aerosol cleaners.
- Never add any attachments and/or equipment without approval of the manufacturer. Such additions can increase the risk of fire, electric shock, or other personal injury.
- Do not use the TV receiver where contact with or immersion in water is a possibility, such as near bath tubs, sinks, washing machines, swimming pools, etc.
- Do not place the TV on an unstable cart, stand, tripod, bracket, or table where it can fall. A falling TV can cause serious injury to a child or adult, and serious damage to the appliance. Use only with a cart, stand, tripod, bracket, or table recommended by the manufacturer or sold with the TV. Follow the manufacturer's instructions when mounting the unit, and use a mounting accessory recommended by the manufacturer. Move the TV and cart with care. Quick stops, excessive force, and uneven surfaces can make the unit and cart unsteady and likely to overturn.
- Provide ventilation for the TV receiver. The unit is designed with slots in the cabinet for ventilation to protect it from overheating. Do not block these openings with any object, and do not place the TV receiver on a bed, sofa, rug, or other similar surface. Do not place it near a radiator or heat register. If you place the TV receiver on a rack or bookcase, ensure that there is adequate ventilation and that you've followed the manufacturer's instructions for mounting.
- Operate your TV receiver only from the type of power source indicated on the marking label. If you are not sure of the type of power supplied to your home, consult your appliance dealer or local power company.
- Use only a grounded or polarized outlet. For your safety, this TV is equipped with a polarized alternating current line plug having one blade wider than the other. This plug will fit into the power outlet only one way. If you are unable to insert the plug fully into the outlet, try reversing the plug. If the plug still does not fit, contact your electrician to replace your outlet.



- Protect the power cord. Power supply cords should be routed so that they won't be walked on or pinched by objects placed on or against them. Pay particular attention to cords at plugs, convenience receptacles, and the point where they exit from the unit.
- Unplug the TV from the wall outlet and disconnect the antenna or cable system during a lightning storm or when left unattended and unused for long periods of time. This will prevent damage to the unit due to lightning and power-line surges.
- Avoid overhead power lines. An outside antenna system should not be placed in the vicinity of overhead power lines or other electric light or power circuits or where it can fall into such power lines or circuits. When installing an outside antenna system, be extremely careful to keep from touching the power lines or circuits. Contact with such lines can be fatal.
- Do not overload the wall outlet or extension cords. Overloading can result in fire or electric shock.
- Do not insert anything through the openings in the unit, where they can touch dangerous voltage points or damage parts. Never spill liquid of any kind on the TV.
- Ground outdoor antennas. If an outside antenna or cable system is connected to the TV, be sure the antenna or cable system is grounded so as to provide some protection against voltage surges and built-up static charges. Section 810 of the National Electrical Code, ANSI/NFPA No.70-1984, provides information about proper grounding of the mast and supporting structure, grounding of the lead-in wire to an antenna discharge unit, size of grounding conductors, location of antenna discharge unit, connection to grounding electrodes, and requirements for the grounding electrode.

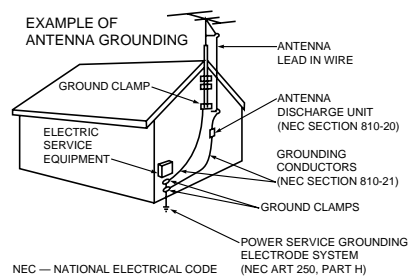

- Do not attempt to service the TV yourself. Refer all servicing to qualified service personnel. Unplug the unit from the wall outlet and refer servicing to qualified service personnel under the following conditions:
 - when the power-supply cord or plug is damaged
 - if liquid has been spilled on the unit or if objects have fallen into the unit
 - if the TV has been exposed to rain or water
 - if the TV does not operate normally by following the operating instructions
 - if the TV has been dropped or the cabinet has been damaged
 - when the TV exhibits a distinct change in performance
- If you make adjustments yourself, adjust only those controls that are covered by the operating instructions. Adjusting other controls may result in damage and will often require extensive work by a qualified technician to restore the TV to normal.
- When replacement parts are required, be sure the service technician uses replacement parts specified by the manufacturer or those that have the same characteristics as the original part. Unauthorized substitutions may result in additional damage to the unit.
- Upon completion of any service or repairs to this TV, ask the service technician to perform safety checks to determine that the TV is in a safe operating condition.

This device complies with part 15 of the FCC Rules. Operation is subject to the following two conditions:

- (1) This device may not cause harmful interference, and**
- (2) This device must accept any interference that may cause undesired operation.**

This television receiver provides display of television closed captioning in accordance with §15.119 of the FCC rules.

Important Warranty Information Regarding Television Format Viewing

Standard screen format televisions (4:3, the aspect ratio of the screen width to height) are primarily designed to view standard format full-motion video. The images displayed on them should primarily be in the standard 4:3 ratio format and constantly moving. Displaying stationary graphics and images on screen, such as the dark top and bottom letterbox bars (wide screen pictures), should be limited to no more than 15% of the total television viewing per week.

Wide screen format televisions (16:9, the aspect ratio of the screen width to height) are primarily designed to view wide screen format full-motion video. The images displayed on them should primarily be in the wide screen 16:9 ratio format, or expanded to fill the screen if your model offers this feature, and constantly moving. Displaying stationary graphics and images on screen, such as the dark side-bars on non-expanded standard format television video and programming, should be limited to no more than 15% of the total television viewing per week.

Additionally, viewing other stationary images and text such as stock market reports, video game displays, station logos, web sites or computer graphics and patterns, should be limited as described above for all televisions. *Displaying any stationary images that exceed the above guidelines can cause uneven aging of picture tubes (CRTs) that leave subtle, but permanent burned-in ghost images in the television picture. To avoid this, vary the programming and images, and primarily display full screen moving images, not stationary patterns or dark bars.* On television models that offer picture sizing features, use these controls to view the different formats as a full screen picture.

Be careful in the selection and duration of television formats used for viewing. Uneven CRT aging as a result of format selection and use, as well as other burned-in images, is not covered by your Samsung limited warranty.

A Guide to Digital TV

What is Digital Television?

Digital television (DTV) is a new way of transmitting high quality video and audio to your TV set. Using DTV, broadcasters can transmit high definition TV (HDTV) images, Dolby digital surround audio, and new services such as multicasting (transmitting more than one program on the same TV channel) and datacasting (providing electronic program guides and interactive television). Several of these services can be combined into a single digital broadcast.

Digital Television Services

Digital Picture Quality

DTV programs are transmitted in two different formats. The first is Standard Definition Television (SDTV) and the second is High Definition Television (HDTV).

SDTV program formats include 480-line interlaced (480i) and 480-line progressive (480p) video. 480i programs are essentially a digital version of our current analog TV programs, while the 480p format offers improved image detail over 480i. Some 480p programs are broadcast in widescreen and are comparable to progressive-scan DVD movies in image quality.

HDTV program formats include 1080-line interlaced (1080i) and 720-line progressive (720p). Both HDTV formats are always broadcast in widescreen, and offer much higher picture quality than SDTV.

Dolby Surround Sound

With DTV, you can listen to a variety of Dolby digital audio formats from Dolby Surround 2.0 to Dolby Digital 5.1 surround, using your home audio system. Many HDTV programs are now broadcast with DD 5.1 soundtracks.

Interactive Communications and Datacasting

DTV will allow you to interact with your television; choosing programs from a detailed program guide, ordering products on-line while watching TV, and accessing ancillary data about a program.

How to View Digital Television

There are three ways to watch DTV. The first is to use an integrated digital TV; one with a built-in digital television tuner. The second is to connect an external DTV set-top receiver to a DTV-ready television or monitor. This type of TV or monitor will have wideband component video and stereo audio inputs. You can also watch DTV signals with personal computer (PC) tuner cards and computer monitors.

1. Integrated TVs versus DTV-ready TVs and monitors

The advantage of an integrated DTV set is that it can tune both analog and digital TV channels at the same time. All you'll need to do is add an external antenna and you are ready to watch DTV.

However, integrated DTV sets are not as common as DTV-ready TVs and monitors. If you already own a DTV-ready TV with component video inputs, you can enjoy DTV broadcasts by simply adding a low-cost DTV set-top receiver and antenna.

2. Using a personal computer and monitor

There are plug-in cards available that will receive and display DTV broadcasts on your computer monitor. In addition, many computer monitors will display one or more of the DTV program formats directly. The most compatible format is 480p, which is similar to the VGA (640x480 pixel) computer display standard. You may be able to watch DTV broadcasts by connecting a computer monitor to the 15-pin jack on the rear of the set-top DTV receiver.

NOTE

This television receiver supports the copy protection system regulated by DTLA (Digital Transmission Licensing Administrator). It should be noted that copy protected content may not be viewable depending on your particular connections.

Q&A

1. Is the antenna I use for existing TV reception good enough for DTV?

Over-the-air (OTA) digital TV broadcasting uses the same channels as analog TV and works well with many existing TV antennas. However, DTV broadcast channel assignments are different than analog channels. You should find out whether your local DTV broadcasts are on VHF (channels 2-13) or UHF (channels 14-69) to see if you need a different antenna.

If your DTV channels are on UHF and you already get good UHF reception, your present antenna may work fine. The same holds true for VHF DTV reception. Note that in some markets, both VHF and UHF channels are used for DTV broadcasts.

You can find out the latest DTV channel assignments for your area by browsing selected Internet web sites such as www.titantv.com, www.10000watts.com, and www.fcc.gov.

2. How difficult is it to receive DTV signals indoors?

This depends on whether your local DTV stations are running full power or not and how close your location is to the transmission tower. DTV receivers do not require as much signal as analog TV receivers to produce high-quality images and sound.

Once the DTV signal level exceeds a certain threshold at the receiver, the digital video and audio data is decoded at the same quality it was originally encoded for broadcast. This is a big advantage for DTV over analog TV - there is no noise, ghosting, static, or scratchy audio.

3. How can I connect an antenna in my townhouse, co-operative apartment, condominium, or apartment?

The Federal Communications Commission's OTARD Rule (part of the Telecommunications Act of 1996) allows residents of condominiums, townhouse, or members of neighborhood associations to put up outside antennas for reception of broadcast TV signals as long as those antennas are not located in common areas and are no more than 12' in height.

Residents of rental units (apartments, etc) are not covered by the OTARD rules and will have to use indoor antennas to receive DTV broadcasts. It is possible that the landlord of an apartment complex can provide broadcast DTV signals via a master TV antenna system to each apartment.

4. Can I connect my DTV set-top receiver to my cable TV service?

Cable TV systems use a different method for transmitting digital TV programs that is currently incompatible with broadcast DTV set-top receivers. So you will still need to use an outdoor or indoor antenna to receive OTA broadcast DTV programs.

The good news is that you won't have to pay a monthly or per-program charge to watch OTA DTV and HDTV programs. They're free, unlike subscription satellite TV or premium cable TV. All you need is an antenna and a DTV set-top receiver to enjoy clear, sharp widescreen images and high-quality audio.

CONTENTS

Chapter 1: Your New TV11

List of Features	11
Accessories	11
Familiarizing Yourself with Your New TV	12
Front Panel Buttons	12
Side Panel Jacks	13
Using the Component Shelf	13
Rear Panel Jacks	14
Remote Control	15

Chapter 2: Installation 17

Connecting VHF and UHF Antennas	17
Antennas with 300-ohm Flat Twin Leads	17
Antennas with 75-ohm Round Leads	18
Separate VHF and UHF Antennas	18
Connecting Cable TV	18
Cable without a Cable Box	18
Connecting to a Cable Box that Descrambles All Channels	19
Connecting to a Cable Box that Descrambles some Channels	19
Connecting a VCR	21
Connecting a Second VCR to Record from the TV	22
Connecting a Camcorder	22
Connecting a DVD Player, DTV Set-Top Box	23
Connecting a DTV Set-Top Box	24
Connecting to DVI(Digital Visual Interface)	24
Connecting a Digital Audio System	25
Connecting a Speakers (Variable Audio Output)	25
Installing Batteries in the Remote Control	26

Chapter 3: Operation27

Turning the TV On and Off	27
Plug & Play Feature	27
Using the Perfect Focus Feature	29
Adjusting Manual convergence	30
Adjust Red Convergence	31
Viewing the Menus and On-Screen Displays	32
Viewing the Menus	32
Viewing the Display	32
Selecting a Menu Language	33
Selecting the Antenna Input	33
Memorizing the Channels	34
Selecting the Video Signal-source	34
Storing Channels in Memory	35
Changing Channels	36
Using the Channel Buttons	36
Using the Number Buttons	36
Using the Previous Channel	36
Selecting Your Favorite Channels	37
To Store Your Favorite Channels	37
To View Your Favorite Channels	37
Adding and Erasing Channels	38
Picture Control	39
Customizing the Picture	39
Using Automatic Picture Settings	40
Selecting the Color Tone	41
Sound Control	42
Adjusting the Volume	42
Using Mute	42
Customizing the Sound	42

CONTENTS

Using Automatic Sound Settings	43
Chapter 3: Operation (Cont.)	44
Setting the Clock	44
Option 1: Setting the Clock Manually	44
Option 2: Setting the Clock Automatically	45
Viewing an External Signal Source	46
Setting the Signal Source	46
Assigning Names to External input mode	46
Chapter 4: Special Features	48
Fine Tuning Analog Channels	48
Checking the Digital-Signal Strength	49
Changing the Screen Size	50
DNLe (Digital Natural Image engine)	51
Viewing Picture-in-Picture	52
Activating Picture-in-Picture	52
Selecting a Signal Source (External A/V) for PIP	53
Swapping the Contents of the PIP Image and Main Image	54
Changing the Size of the PIP Window	55
Changing the Position of the PIP	56
Changing the PIP Channel	57
Extra sound settings (Auto Volume, BBE)	58
Auto Volume	58
BBE	59
Choosing a Multi-Channel Sound (MTS)	
Soundtrack	60
When a Digital Signal is received	60
When an Analog Signal is received	61
Setting the On/Off Timer	62
Setting the Sleep Timer	64
Rating Control Menu	65
How to Change Your Password	65
How to Set up Restrictions Using the "TV Parental Guidelines"	66
How to Set up Restrictions using the Movie Ratings:	
G, PG, PG-13, R, NC-17, X	67
Important Notes About Parental Locks	68
Viewing Closed Caption	69
Setting Up Digital Caption (On-Screen Text Messages)	69
Setting Up Analog Caption (On-Screen Text Messages)	71
Menu Translucency Level	72
Setting the Function Help	73
Electronic Program Guide	74
Using the Electronic Program Guide	75
Viewing Information about a Single Channel	76
Viewing Information about Channels	77
Reminder List	78
Reminded Viewing List	78
To view the Reminder List	79
Customizing Your Remote Control	80
Setting Up Your Remote Control to Operate Your VCR (or DVD)	80
Setting Up Your Remote Control to Operate Your Cable Box	81
Chapter 5: Troubleshooting	83
Identifying Problems	83
Appendix	84
Cleaning and Maintaining Your TV	84
Using Your TV in Another Country	84
Specifications	84

Chapter One

YOUR NEW TV

List of Features

Your Samsung TV was designed with the latest technology. This TV is a high-performance unit that includes the following special features:

- Easy-to-use remote control
- Easy-to-use on-screen menu system
- Automatic timer to turn the TV on and off
- Adjustable picture and sound settings that can be stored in the TV's memory
- A special filter to reduce or eliminate reception problems
- Fine tuning control for the sharpest picture possible
- A built-in multi-channel sound decoder for stereo and bilingual listening
- Built-in, dual channel speakers
- A special sleep timer
- Picture-in-Picture
- Component Video Input jacks to obtain a sharper image from external sources
- Perfect Focus
- DNIe (Digital Natural Image engine) ; Samsung' s New Technology
- DIGITAL INPUT (Digital Visual Interface) jack
- COAXIAL OUTPUT
- OPTICAL OUTPUT

Precautions When Moving and Installing the Unit

- This Projection Television is provided with casters at its bottom so it can be moved easily. Depending on the material of the floor, it may get scratched when the unit is moved. Care should be taken when moving the unit.
- When you want to install the Projection Television in a given location, or use it on the carpet, make sure to use the accompanying caster trays (4 units). When placing the caster tray beneath the casters, be sure your fingers do not get caught.

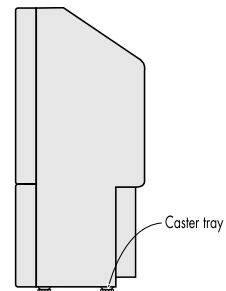

Accessories

Once you have unpacked your TV, check to make sure that you have all the parts shown here. If any piece is missing or broken, call your dealer.

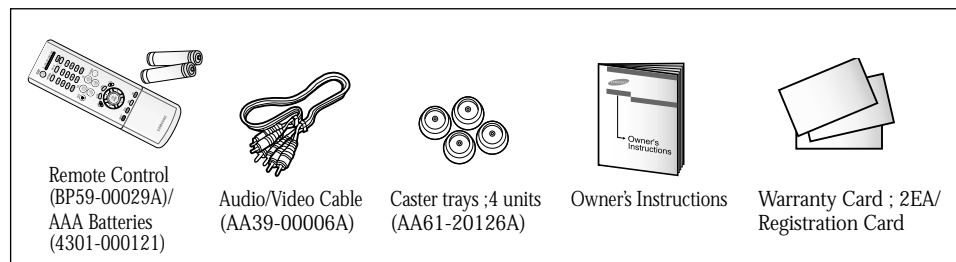

YOUR NEW TV

Familiarizing Yourself with Your New TV

Front Panel Buttons

The buttons on the front panel control your TV's basic features, including the on-screen menu. To use the more advanced features, you must use the remote control.

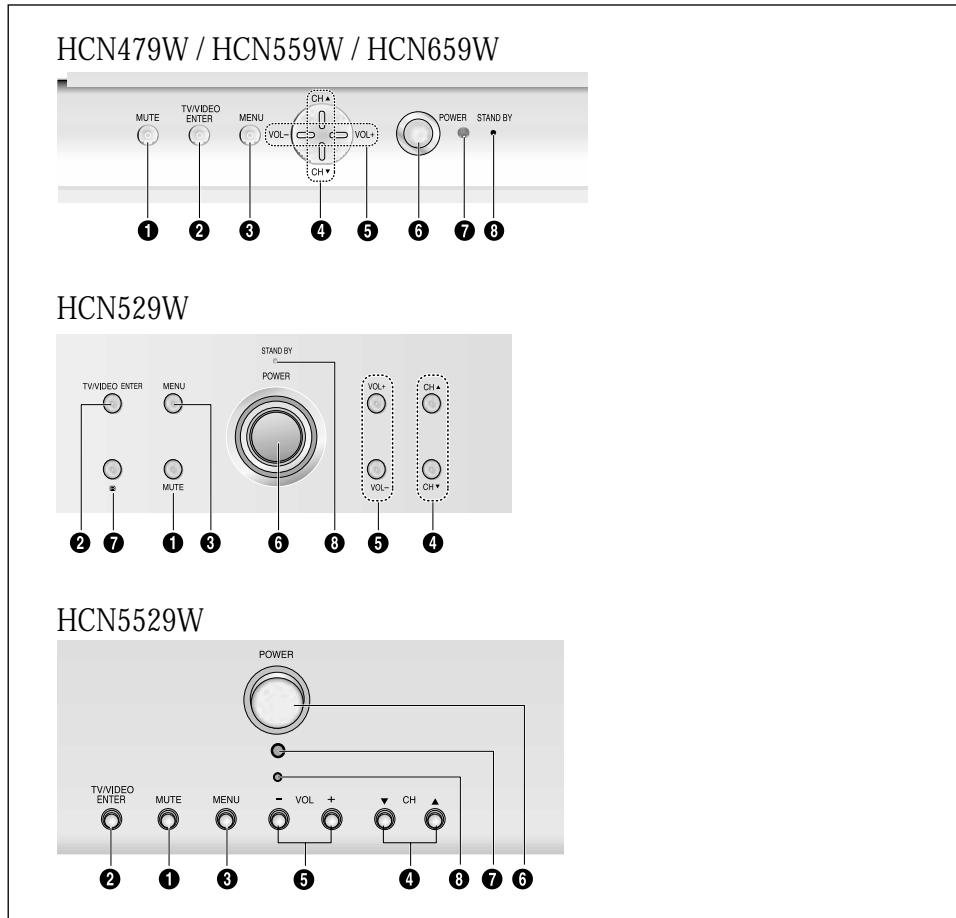

- 1 MUTE**
Press to temporarily cut off the sound.
- 2 TV/VIDEO & ENTER**
All the inputs connected to the external component jacks will be shown in regular sequence. When the menu appears, use the CH buttons to highlight a particular source, and then press the ENTER button to select it.
- 3 MENU**
Press to see an on-screen menu of your TV's features.
- 4 CH▼ and CH▲**
Press to change channels. Also, press to highlight various items on the on-screen menu.
- 5 VOL - , +**
Press to increase or decrease the volume. Also used to select items on the on-screen menu.
- 6 POWER**
Press to turn the TV on and off.
- 7 Remote Control Sensor**
Aim the remote control towards this spot on the TV.
- 8 STAND BY indicator**
Lights up when you turn the power off.

YOUR NEW TV

Side Panel Jacks

You can use the side panel jacks to connect an A/V component that is used only occasionally, such as a camcorder or video game. (For information on connecting equipment, see pages 17 – 25.)

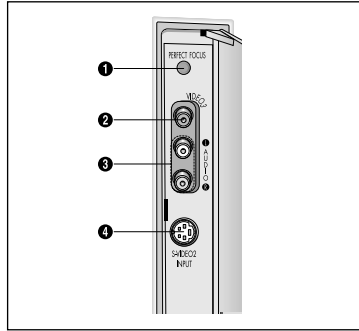

- 1 PERFECT FOCUS**
Press to adjust for the optimum picture set in the Factory.
- 2 VIDEO INPUT jack**
Use to connect a video signal from a camcorder or a video game.
- 3 AUDIO INPUT jacks**
Use to connect the audio signals from a camcorder or video game.
- 4 S-VIDEO INPUT jack**
Use to connect an S-Video signal from a camcorder or a video game.

Using the Component Shelf

You can place a VCR, a DVD player, etc. on the Component Shelf.

HCN479W / HCN559W / HCN659W

1 Press the symbol "⏏" in the center of the Component Shelf door.	2 As shown in figure below, hold the center of the door and lift it up.	3 After placing a component on the shelf, hold the center of the door and pull it down as shown in figure below.	4 Shut the door by pressing the "⏏" symbol.
			Note: When placing a component on the shelf, make sure it is no more than 5 inches tall and leave one inch of space from the front and sides for ventilation.

YOUR NEW TV

Rear Panel Jacks

Use the rear panel jacks to connect an A/V component that will be connected continuously, such as a VCR or a DVD player.

Because there are two sets of input jacks, you can connect two different A/V components (i.e., a VCR and a DVD, 2 VCRs, etc.)

For more information on connecting equipment, see pages 17 – 25.

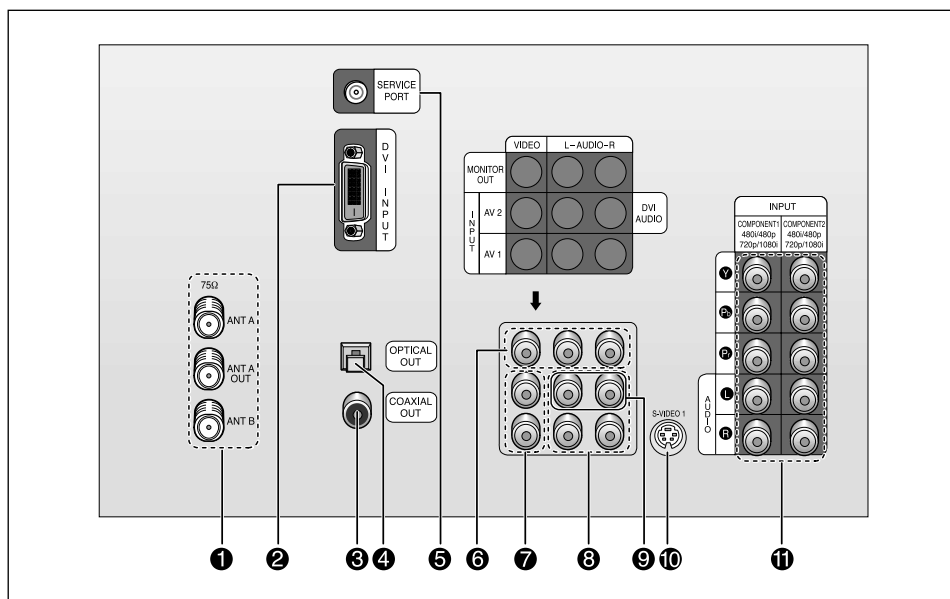

1 ANTENNA terminals

Two independent cables or antennas can be connected to these terminals. Use ANT-A and ANT-B terminals to receive a signal from VHF/UHF antennas or your cable system. Use the ANT-A OUT terminal to send the signal being received by the ANT-A terminal out to another component (such as a Cable Set Top Box). The PIP channel can be received only when a signal source is connected to ANT-A.

2 DIGITAL INPUT (Digital Visual Interface) jack

Receives the digital signals from a Set-top Box.

3 COAXIAL OUTPUT

Connect to the a Digital Audio component.

4 OPTICAL OUTPUT

Connect to the a Digital Audio component.

5 SERVICE PORT

For service only.

6 AUDIO-VIDEO MONITOR OUTPUT jacks

Connect to the audio/video input jacks of a recording VCR.

7 VIDEO INPUT jacks

Connect to the video output jacks of VCRs, DVD players and similar devices (Two sets are available: Video1 and Video2).

8 AUDIO INPUT jacks

Connect to the audio output jacks of VCRs, DVD players and similar devices.

9 DVI AUDIO INPUT jacks

Receives the digital audio signals from a set top box.

10 S-VIDEO INPUT jack

Connect to an S-VHS VCR or DVD player.

11 COMPONENT 1, 2 (480i, 480p, 720p, 1080i) AUDIO/VIDEO INPUT jacks

Connect a source that outputs 480i/480p/720p/1080i Y,P_B and P_R signals, such as a DVD or DTV Set-Top Box.

YOUR NEW TV

Remote Control

You can use the remote control up to about 23 feet from the TV. When using the remote, always point it directly at the TV.

You can also use your remote control to operate your VCR and cable box. See page 80 for details.

1 Power

Turns the TV on and off.

2 ANTENNA

Press to select the ANT A or ANT B.

3 Fav. CH (Favorite Channel)

Press to switch between your favorite channels.

4 Number buttons

Press to select channels directly on the TV.

5 +100

Press to select channels over 100. For example, to select channel 121, press "+100," then press "2" and "1."

6 VOL -, VOL +

Press increase or decrease the volume.

7 Mute

Press to temporarily cut off the sound.

8 GUIDE

Press to display the on-screen Electronic Program Guide(EPG).

9 Menu

Displays the main on-screen menu.

10 Up/Down Left/Right buttons

Control the cursor in the menu.

11 Aspect

Press to change the screen size.

12 Still(Main)

Press to stop the action during a particular scene. Press again to resume normal video.

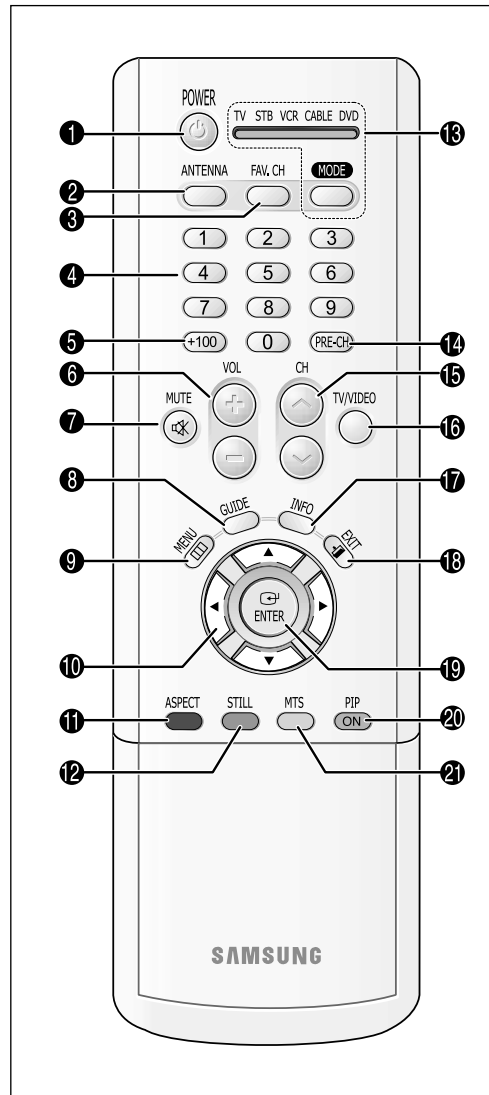

13 Mode

Selects a target device to be controlled by the Samsung remote control(i.e., TV, STB, VCR, Cable box or DVD).

14 PRE-CH

Tunes to the previous channel.

15 CH ∨ and CH ∧ (Channel Up/Down)

Press CH ∨ or CH ∧ to change channels.

16 TV/Video

Each time the button is pressed, all the inputs connected to the external component jacks will be shown in regular sequence.

17 INFO

Press to display information about the current box settings and program :
Channel number, Time, Program title, Program duration, Caption, Rating control, Digital picture grade and MTS language.

18 EXIT

Press to exit the menu.

19 ENTER

While using the on-screen menus, press ENTER to activate(or change) a particular item.

20 PIP

Activates picture in picture.

21 MTS (Multichannel Television Sound)

Press to choose stereo, mono or Secondary Audio Program (SAP broadcast).

YOUR NEW TV

Remote Control (continued)

22 S.Mode
Adjust the TV sound by selecting one of the preset factory settings (or select your personal, customized sound settings).

23 P.Mode
Adjust the TV picture by selecting one of the preset factory settings (or select your personal, customized picture settings).

24 DNie
Activates DNie (Digital Natural Image engine).

25 BBE
BBE is a built-in effect that adds clarity, punch and dynamics to the sound.

26 VCR controls
Controls VCR tape functions: Rewind, Play, Fast Forward, Stop, Pause.

REW (Rewind)

Press to rewind a tape in your VCR.

Stop

Press this button to stop a tape during play, record, rewind or fast forward. If the button is pressed during Full-Automatic play, the function will be cancelled.

Play/Pause

Press the Play/Pause button to play back prerecorded tapes or pause the tape.

FF

Press to fast forward the tape in your VCR.

27 SET
Used during set up of this Samsung remote control, so that it will work compatibly with other devices (VCR, cable box, DVD.)

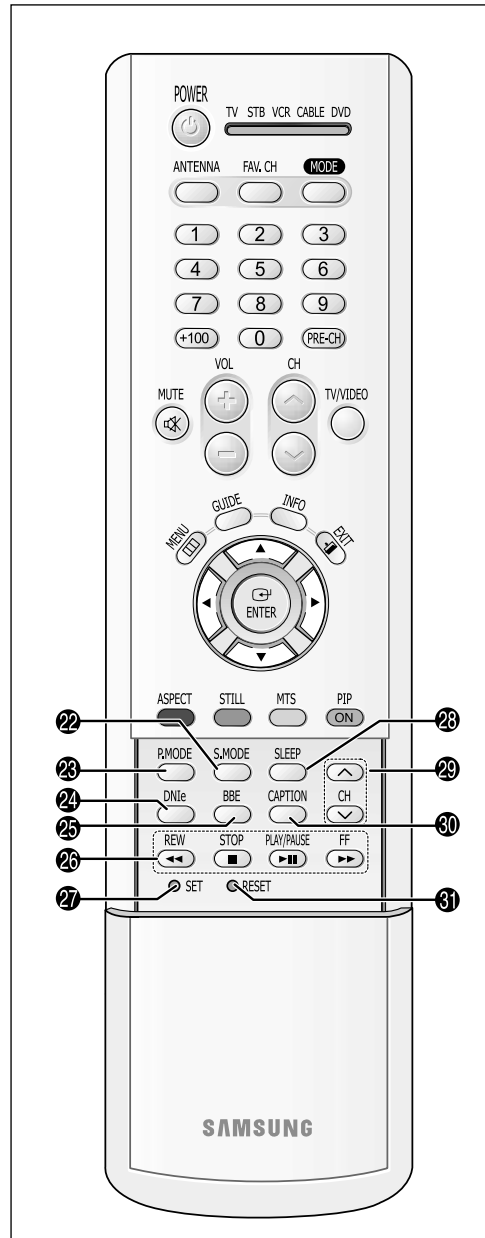

28 Sleep
Press to select a preset time interval for automatic shutoff.

29 PIP Controls

CH

Displays the available channels in sequence. (These buttons change channels in the PIP window only).

30 Caption

Controls the caption decoder.

31 Reset

If your remote control is not functioning properly, take out the batteries and press the reset button for about 2-3 seconds. Re-insert the batteries and try using the remote control again.

Chapter Two

INSTALLATION

Connecting VHF and UHF Antennas

If your antenna has a set of leads that look like this, see “Antennas with 300-ohm Flat Twin Leads,” below.

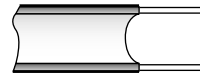

If your antenna has one lead that looks like this, see “Antennas with 75-ohm Round Leads,” on page 18.

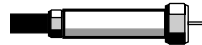

If you have two antennas, see “Separate VHF and UHF Antennas,” on page 18.

Antennas with 300-ohm Flat Twin Leads

If you are using an off-air antenna (such as a roof antenna or “rabbit ears”) that has 300-ohm twin flat leads, follow the directions below.

1

Place the wires from the twin leads under the screws on the 300-75 ohm adaptor (not supplied). Use a screwdriver to tighten the screws.

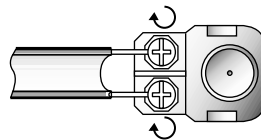

2

Plug the adaptor into the ANT-A or ANT-B terminal on the rear panel.

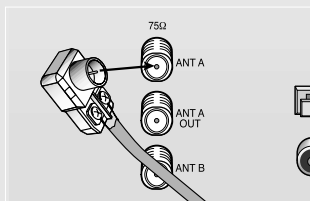

INSTALLATION

Antennas with 75-ohm Round Leads

Plug the antenna lead into the ANT-A or ANT-B terminal on the rear panel.

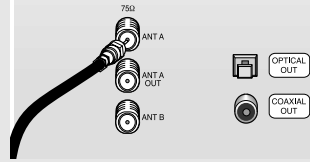

Separate VHF and UHF Antennas

If you have two separate antennas for your TV (one VHF and one UHF), you must combine the two antenna signals before connecting the antennas to the TV. This procedure requires a optional combiner-adaptor (available at most electronics shops).

1

Connect both antenna leads to the combiner.

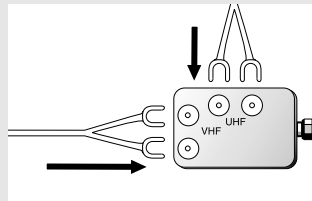

2

Plug the combiner into the ANT-A or ANT-B terminal on the rear panel.

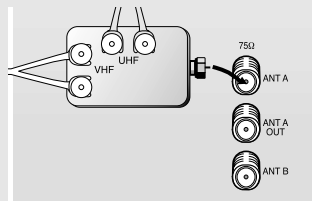

Connecting Cable TV

You can connect different cable systems to your TV, including cable without a cable box, and cable with a cable box that descrambles some or all channels.

Cable without a Cable Box

If you want to connect cable, and you do not need to use a cable box:

Plug the incoming cable into the ANT-A or ANT-B antenna terminal on the rear of the TV.

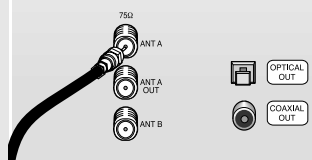

INSTALLATION

Cable with a Cable box that Descrambles All Channels

1

Find the cable that is connected to the ANTENNA OUT terminal on your cable box. This terminal might be labeled "ANT OUT", "VHF OUT", or simply, "OUT".

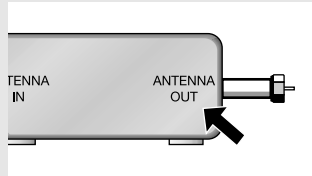

2

Connect the other end of this cable to the ANT-A or ANT-B terminal on the rear of the TV.

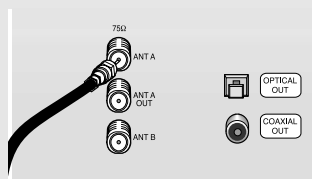

Connecting to a Cable Box that Descrambles Some Channels

If your cable box descrambles only some channels (such as premium channels), follow the instructions below. You will need a two-way splitter, an RF (A/B) switch, and four lengths of coaxial cable. (These items are available at most electronics stores.)

1

Find and disconnect the cable that is connected to the ANTENNA IN terminal on your cable box.

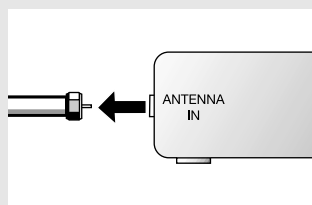

◀ This terminal might be labeled "ANT IN," "VHF IN," or simply, "IN."

2

Connect this cable to a two-way splitter.

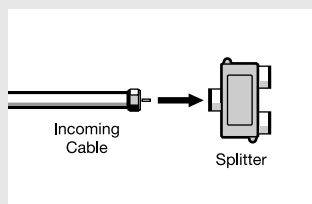

3

Connect a coaxial cable between an OUTPUT terminal on the splitter and the IN terminal on the cable box.

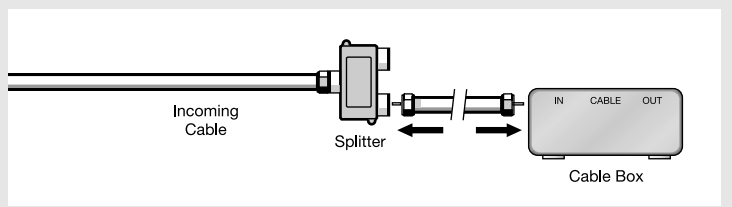

INSTALLATION

4

Connect a coaxial cable between the ANTENNA OUT terminal on the cable box and the B-IN terminal on the A/B switch.

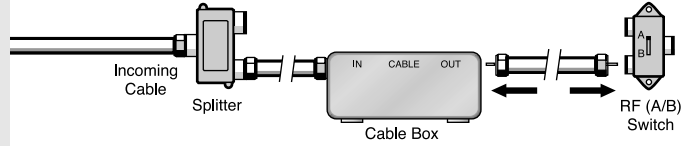

5

Connect another cable between the other OUT terminal on the splitter and the A-IN terminal on the RF (A/B) switch.

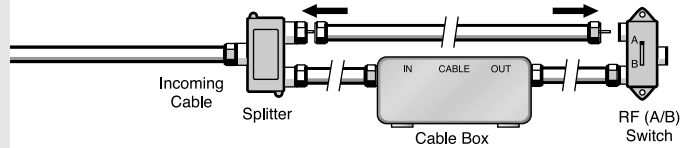

6

Connect the last coaxial cable between the OUT terminal on the RF (A/B) switch and the VHF/UHF terminal on the rear of the TV.

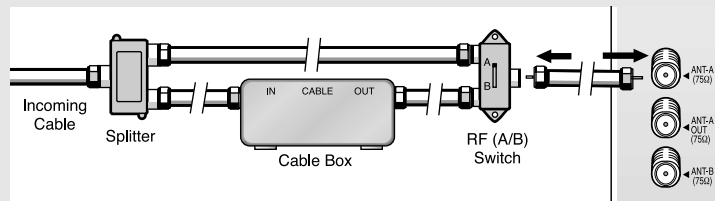

After you've made this connection, set the A/B switch to the "A" position for normal viewing. Set the A/B switch to the "B" position to view scrambled channels. (When you set the A/B switch to "B," you will need to tune your TV to the cable box's output channel, which is usually channel 3 or 4.)

INSTALLATION

Connecting a VCR

These instructions assume that you have already connected your TV to an antenna or a cable TV system (according to the instructions on pages 17 - 20). Skip step 1 if you have not yet connected to an antenna or a cable system.

1

Connect a coaxial cable between the ANTENNA OUT terminal on the VCR and the antenna terminal on the TV.

A coaxial cable is usually included with a VCR. (If not, check your local electronics store).

2

Connect a set of audio cables between the AUDIO OUT jacks on the VCR and the AUDIO jacks on the TV.

If you have a mono VCR, connect L (mono) to VCR audio out using only one audio cable.

3

Connect a video cable between the VIDEO OUT jack on the VCR and the VIDEO jack on the TV.

If you have a S-VHS VCR, use the S-Video connections and remove the video cable. Do not connect the video cable and the S-Video cable to video 1 simultaneously.

Follow the instructions in "Viewing a VCR or Camcorder Tape" to view your VCR tape.

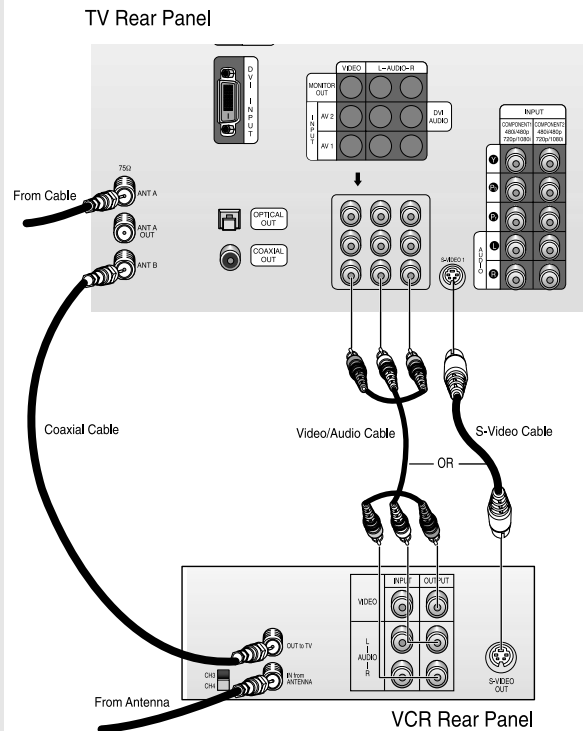

INSTALLATION

Connecting a Second VCR to Record from the TV

Your TV can send out signals of its picture and sound to be recorded by a second VCR. To do this, connect your second VCR as follows:

1

Connect a set of audio cables between the AUDIO OUT jacks on the TV and the AUDIO IN jacks on the VCR.

(The VCR input jacks might be either on the front or rear of the VCR.)

2

Connect a video cable between the VIDEO OUT jack on the TV and the VIDEO IN jack on the VCR.

Refer to your VCR's instructions for more information about how to record using this kind of connection.

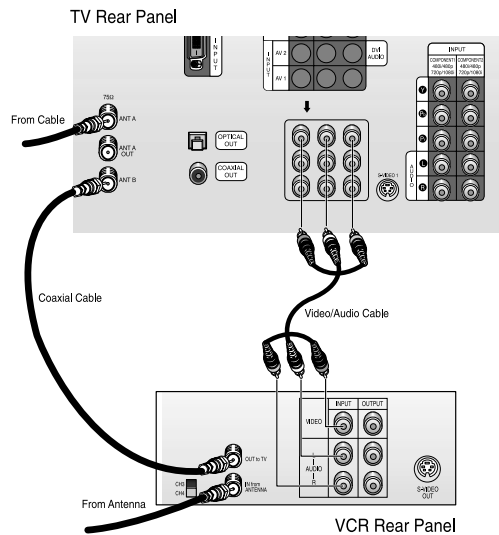

Connecting a Camcorder

The side panel jacks on your TV make it easy to connect a camcorder to your TV. They allow you to view the camcorder tapes without using a VCR.

1

Locate the A/V output jacks on the camcorder. They are usually found on the side or rear of the camcorder.

2

Connect an audio cable between the AUDIO OUTPUT jack on the camcorder and the AUDIO terminals on the side of the TV.

If you have mono camcorder, connect L(mono) to camcorder audio out using only one audio cable.

3

Connect a video cable between the VIDEO OUTPUT jack on the camcorder and the VIDEO terminal on the side of the TV.

The audio-video cables shown here are usually included with a Camcorder. (If not, check your local electronics store.) If your camcorder is stereo, you need to connect a set of two cables.

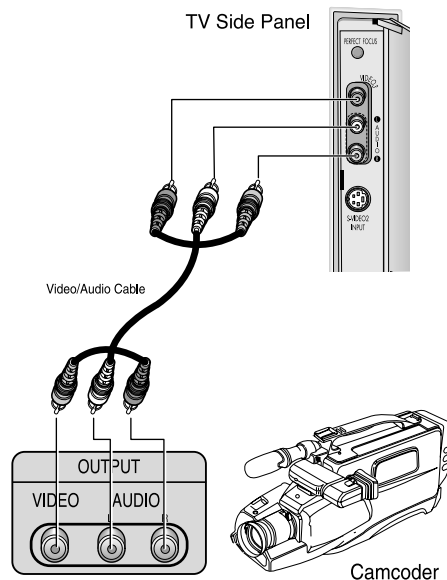

INSTALLATION

Connecting a DVD Player or DTV Set-top Box (480i, 480p, 720p, 1080i)

The rear panel jacks on your TV make it easy to connect a DVD player to your TV.

Connecting to Y, P_B, P_R

1

Connect a set of audio cables between the DVD audio in jacks on the TV and the AUDIO OUT jacks on the DVD player (or DTV Set-top Box).

2

To enable Component video viewing, connect video cables between the Y, P_B, and P_R inputs on the TV and Y, P_B, and P_R (or Y, C_B, C_R) outputs on the DVD player (or DTV Set-top Box).

Note: For an explanation of Component video, see your DVD player's (or DTV Set-top Box) owner's instruction.

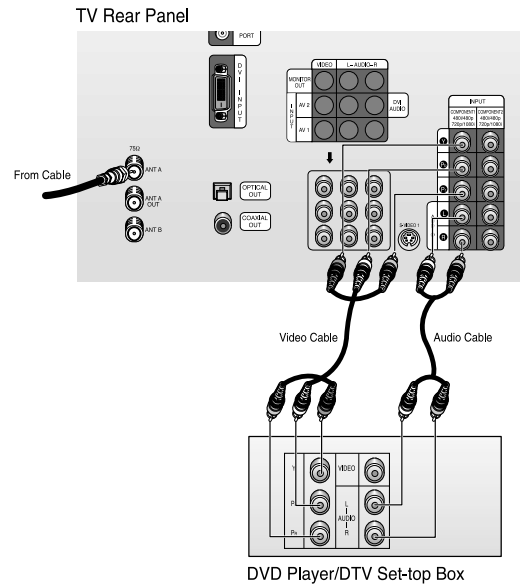

Connecting to regular audio and video jacks

1

Connect a set of audio cables between the AUDIO IN jacks on the TV and the AUDIO OUT jacks on the DVD player (or DTV Set-top Box).

2

Connect video cables between the VIDEO OUT jack on the DVD player (or DTV Set-top Box) and the VIDEO IN jack on the TV.

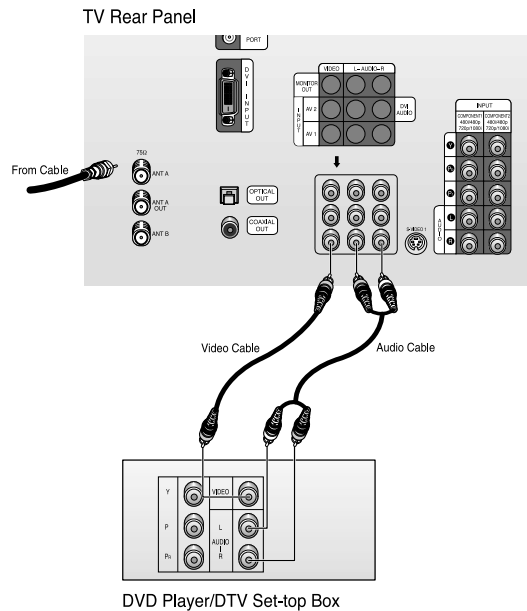

Connecting a DTV Set-Top Box

Connecting to DVI (Digital Visual Interface)

By inputting a high-bandwidth Digital Content Protection high-definition picture source to the DVI INPUT jack on the TV, high-definition pictures can be displayed on the screen in their digital form. (This DVI INPUT jack is for use in the future when High-bandwidth Digital Content Protection DTV decoder, DVD players and D-VHS are put on the market.)

1
Connect a set of audio cables between the AV 2 AUDIO INPUT jacks on the TV and the AUDIO OUT jacks on the DTV Set Top Box.

2
Connect a DVI cable between the DVI INPUT jack on the TV and the DVI OUT jack on the Set Top Box.

Note: For an explanation of Component video, see your DTV Set-top box's owner's instruction.

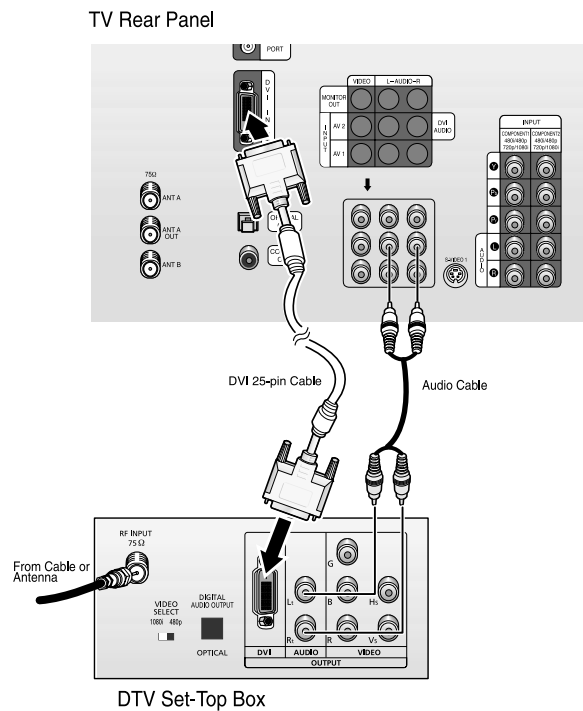

Notes

- The DVI INPUT jack is not compatible with the picture signal of a personal computer.
- Use a DVI 25-pin cable (commercially available) in order to digitally connect the TV with a DTV decoder.

INSTALLATION

Connecting a Digital Audio System

There are many types of audio systems on the market today.

A simplified illustration of an audio system is shown below. For more information, see your audio system owner's manual.

1
If your system has a coaxial digital audio input, connect it to the COAXIAL OUT jack on the TV.

2
If your system has an optical digital audio input, connect it to the OPTICAL OUT jack on the TV.

Be certain to remove the black cover from the optical output before inserting the cable.

3
If your system has both coaxial and optical digital audio inputs, SAMSUNG recommends you use the optical digital output on the TV.

Do not connect both optical and coaxial cables. This may damage your audio system.

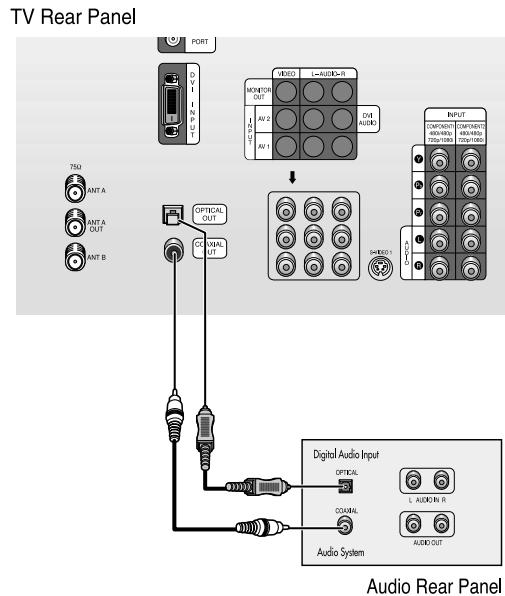

Connecting a Speakers (Variable Audio Output)

1
The "AUDIO OUT" terminals cannot be used for external speakers. You must hook them up to an amplifier.

When an audio amplifier is connected to the "AUDIO OUT" terminals:
Decrease the gain (volume) of the audio amplifier, and adjust the volume level with the volume control on the TV.

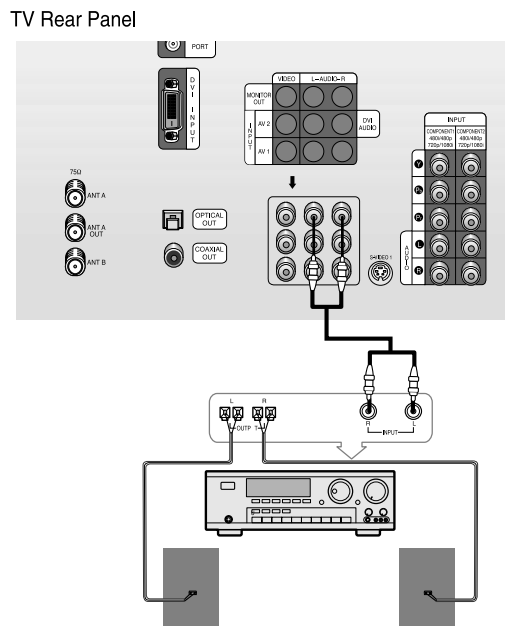

INSTALLATION

Installing Batteries in the Remote Control

1

Slide the back cover all the way out to open the battery compartment of the remote control.

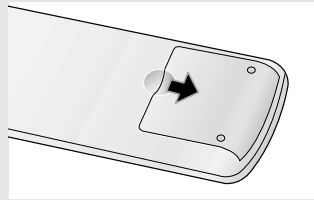

2

Install two AAA size batteries.

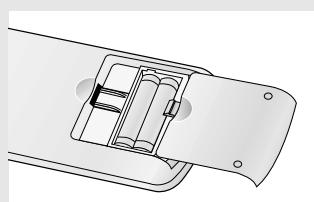

◀ Make sure to match the “+” and “-” ends of the batteries with the diagram inside the compartment.

3

Replace the cover.

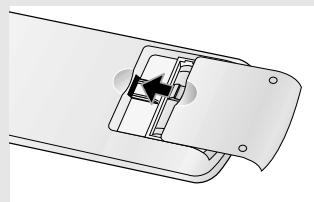

◀ Remove the batteries and store them in a cool, dry place if you won't be using the remote control for a long time.

The remote control can be used up to about 23 feet from the TV.

(Assuming typical TV usage, the Batteries last for about one year.)

Chapter Three

OPERATION

Turning the TV On and Off

Press the **Power** button.
You can also use the POWER button on the front panel.

Plug & Play Feature

When the TV is initially powered On, basic customer settings proceed automatically and subsequently: Setting the language, Antenna input check, Channel Memorize and Time Setting.

Note : The Plug & Play function operates after plugging in the TV for the first time.

1

Press the **Power** button on the remote control.

The message "Menu language channels and time will be set." is displayed. Press the **ENTER** button, then 'Setting Language of OSD' menu is automatically displayed.

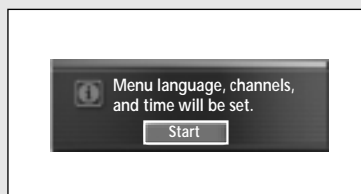

2

Press the **ENTER** button to enter the language. Press the **▼** button to select language, then the **ENTER** button. 'Ant. input check' menu is automatically displayed.

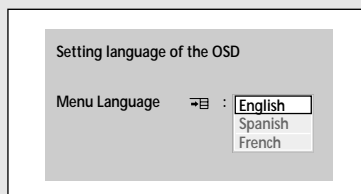

3

Press the **▼** button to memorize the channels of the selected connection. Press the **ENTER** button to select "Start".

When selecting Cable TV : Press the **▼** button to select "Cable", then press the **ENTER** button. Press the **▼** button to cycle through these choices: "STD", "HRC" or "IRC".

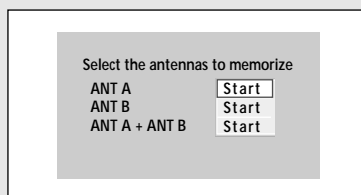
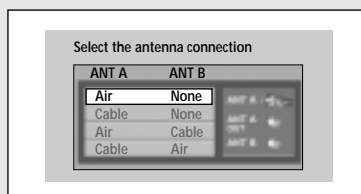

Air	None	ANT A : Air
Cable	None	ANT A : Cable
Air	Cable	ANT A : Air, ANT B : Cable
Cable	Air	ANT A : Cable, ANT B : Air

continued...

OPERATION

4

The TV will begin memorizing all of the available channels.

After all the available channels are stored, the Auto program menu reappears. Press the **ENTER** button when channel memorization is complete.

'Set daylight saving time' menu is automatically displayed.

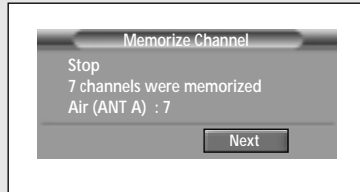
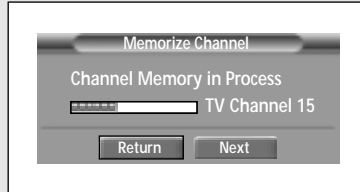

◀ To return to the previous step, move to "Return" by pressing the button and then press the **ENTER** button.

To return to the next step, move to "Next" by pressing the button and then press the **ENTER** button.

5

Press the ▼ button to select "Yes" or "No", then the **ENTER** button.

'Time Zone Picture' menu is automatically displayed.

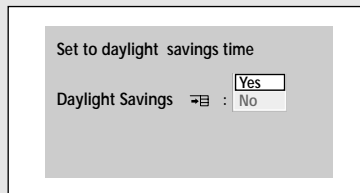

6

Press the ▲ or ▼ button to highlight the time zone for your local area (and to move highlight to the appropriate time zone on the map of the United States). Press **ENTER**.

That's it. If you have received a digital signal, the time will be set automatically. If not, see page 44 to set the clock.



7

The message "Completed. Time will be updated automatically." is displayed. When you have finished, press the **ENTER** button.

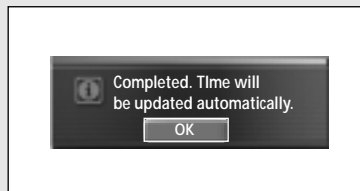

Using the Perfect Focus Feature

When the picture size is distorted after moving the TV set, use the Perfect Focus feature to adjust for the optimum picture size set in the Factory.

1

Press the **MENU** button.

Press the **▼** button to select "Picture", then press the **ENTER** button.

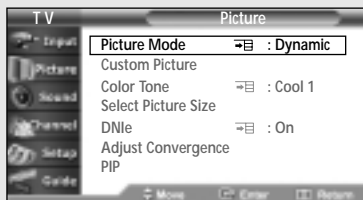

2

Press the **▼** button to select "Adjust Convergence", then press the **ENTER** button.

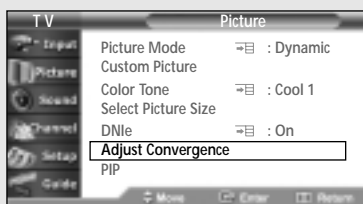

3

Press the **▼** button to select "Perfect Focus", then press the **ENTER** button.

Perform Perfect Focus in the following sequence:
Green → Red → Blue.

Press **MENU** button to return.

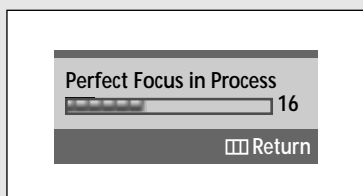
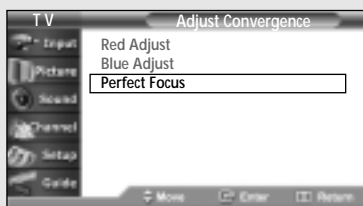

Notes

- If any error happens during Perfect Focus, then perform Perfect Focus once again.
- If you can't make adjustments after Perfect Focus, then make manual adjustments. If you still can't make adjustments, contact a Samsung authorized Service Center.
- The Data to be controlled with Manual adjustet won't be cared while the Perfect Focus are working.
- Plese adjust it in 30 mins after turing on SET while the Perfect Focus are working.

Adjusting Manual Convergence

If the color appears spread out or “smeared” on the screen, the convergence probably needs alignment. Be sure to use the remote control for the convergence adjustments.

First steps:

1

Press the **MENU** button.

Press the **▼** button to select “Picture”, then press the **ENTER** button.

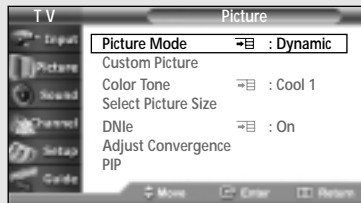

2

Press the **▼** button to select “Adjust Convergence”, then press the **ENTER** button.

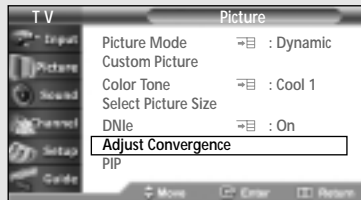

3

Press the **ENTER** button to select “Red Adjust”, then press the **ENTER** button again.



continued...

OPERATION

Adjust Red Convergence

4

A crosshair pattern will appear on the screen.

After moving the cursor to the position you want to adjust using the **▲**, **◀**, **▶**, **▼** buttons on the remote control, adjust Red Convergence by pressing the **VOL +/VOL -/CH ^/CH v**.

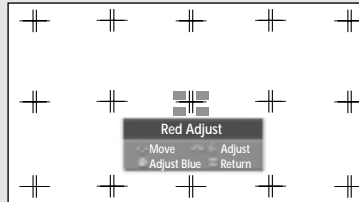

5

If a horizontal red line is visible, use **CH ^** and **CH v** buttons to move the line so that it is superimposed on the horizontal center-line (i.e., make a single horizontal line that is as white as possible.)

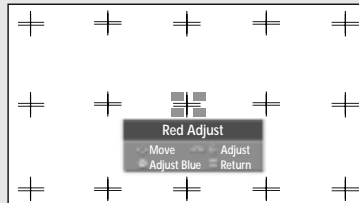

6

If a vertical red line is visible, use the **VOL +** and **VOL -** buttons to move the line so that it is superimposed on the vertical-center line (i.e., make a single vertical line that is as white as possible.)

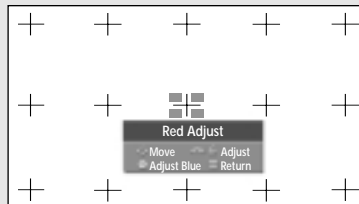

7

For 'Blue' adjustment, do the same as the above.

After the red convergence is correctly adjusted, press **EXIT** to exit all the menus.

Viewing the Menus and On-Screen Displays

Viewing the Menus

1

With the power on, press the **MENU** button.

The "Input" menu appears on the screen. Its left side has six icons: Input, Picture, Sound, Channel, Setup and Guide.



2

Press the **▲** or **▼** button to move to items in the menu (the icons blink when highlighted). Press the **▶** or **◀** button to display, change or use the selected items. Press the **ENTER** button to enter items in the menu.



3

Press the **EXIT** button to exit.

Viewing the Display

The display identifies the current channel and the status of certain audio-video settings.

1

Press the **INFO** button on the remote control.

The TV will display the Picture Mode, Sound Mode, MTS, Time.

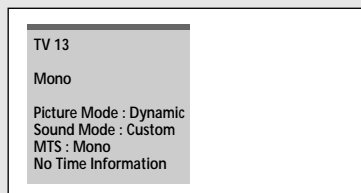

OPERATION

Selecting a Menu Language

1

Press the **MENU** button.

Press the **▼** button to select "Setup", then press the **ENTER** button.

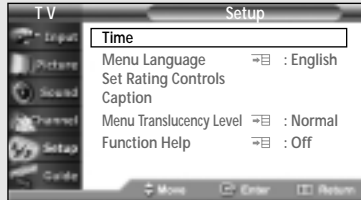

2

Press the **▼** button to select "Menu Language", then press the **ENTER** button.

Press the **▼** button to select "English", then press the **ENTER** button.

Press the **EXIT** button to exit.



Selecting the Antenna Input

You can connect to two different signal sources by choosing the antenna input (Antenna A or Antenna B).

1

Press the **ANTENNA** button, then press the **ANTENNA** button repeatedly to select the "ANT A" or "ANT B".

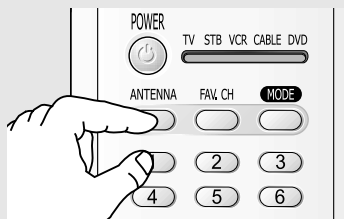

Memorizing the Channels

Your TV can memorize and store all of the available channels for both “off-air” (antenna) and cable channels. After the available channels are memorized, use the CH \wedge and CH \vee buttons to scan through the channels. This eliminates the need to change channels by entering the channel digits. There are three steps for memorizing channels: selecting a broadcast source, memorizing the channels (automatic) and adding and deleting channels (manual).

Selecting the Video Signal-source

Before your television can begin memorizing the available channels, you must specify the type of signal source that is connected to the TV (i.e., an antenna or a cable system).

1

Press the **MENU** button.

Press the \blacktriangledown button to select “Channel”, then press the **ENTER** button.

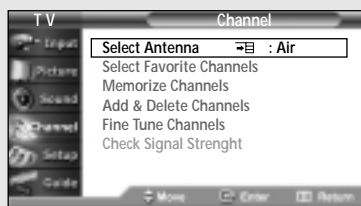

2

Press the **ENTER** button to select “Select Antenna”, then press the **ENTER** button.

Press the \blacktriangledown button to select “Air” or “Cable”, then press the **ENTER** button.



3

Press the \blacktriangledown button to select “Memorize Channels”, then press the **ENTER** button.

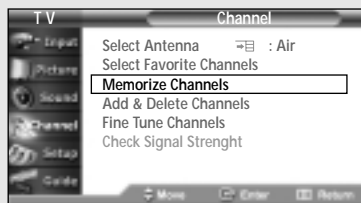

OPERATION

4

Press the **▼** button to select antenna connection, then press the **ENTER** button

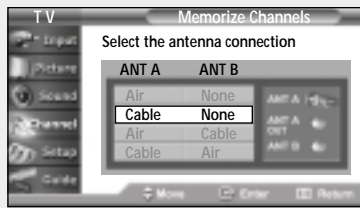

When selecting Cable TV system: Press the **▼** button to select "Cable", then Press the **ENTER** button. Press the **▼** button to cycle through these choices: "STD", "HRC" or "IRC".

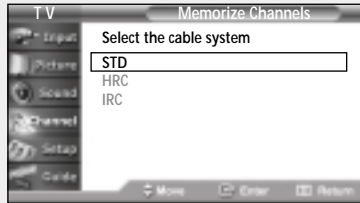

Air	None	ANT A : Air
Cable	None	ANT A : Cable
Air	Cable	ANT A : Air, ANT B : Cable
Cable	Air	ANT A : Cable, ANT B : Air

Notes

- STD, HRC and IRC identify various types of cable TV systems. Contact your local cable company to identify the type of cable system that exists in your particular area. At this point the signal source has been selected. Proceed to "Storing Channels in Memory".
- Subscription cable services require service-specific equipment for viewing.

Storing Channels in Memory

5

Press the **▼** button to select the antennas to memorize. Press the **ENTER** button to select "Start".

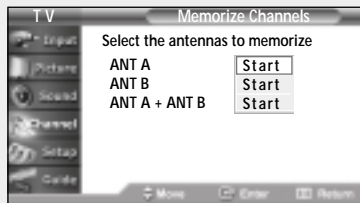

6

The TV will begin memorizing all of the available channels.

After all the available channels are stored, the Auto program menu reappears. Press the **ENTER** button when channel memorization is complete.



◀ Note: The TV MUST be connected to an antenna in order to receive digital TV signals. Even if a particular channel is deleted from the memory, you can always tune to that channel directly by using the number buttons on the remote control.

◀ To return to the previous step, move to "Return" by pressing the **◀** button and then press the **ENTER** button.

Note: When Receiving Digital Cable Signal :

If your cable service signal does not comply with the ATSC requirement, this product may not operate properly.

Changing Channels

Using the Channel Buttons

Press the **CH \wedge** or **CH \vee** button to change channels.

When you press **CH \wedge** or **CH \vee** , the TV changes channels in sequence. You will see all the channels that the TV has memorized. (The TV must have memorized at least three channels.) You will not see channels that were either erased or not memorized.

Using the Number Buttons

Use the number buttons to quickly tune to any channel.

Press the number buttons to go directly to a channel.
For example, to select channel 27, press "2," then "7." The TV will change channels when you press the second number.

When you use the number buttons, you can directly select channels that were either erased or not memorized.

To select a channel over 100, press the +100 button. (For channel 122, press "+100," then "2," then "2.")

To change to single-digit channels (0-9) faster, press "0" before the single digit. (For channel "4," press "0," then "4.")

Using the Previous Channel

Press the **PRE-CH** button.
The TV changes to the last channel you were watching.



Selecting Your Favorite Channels

You can store of your favorite channels for each available input source (such as TV and CATV). Then, when you press the Fav.CH button on the remote control, the TV displays only the favorite channels you previously stored, allowing you to quickly and easily find frequently watched channels.

To Store Your Favorite Channels:

1

Press the **MENU** button.

Press the **▼** button to select "Channel", then press the **ENTER** button.

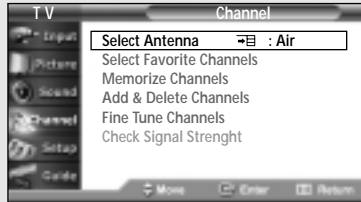

2

Press the **▼** button to select "Select Favorite Channels".

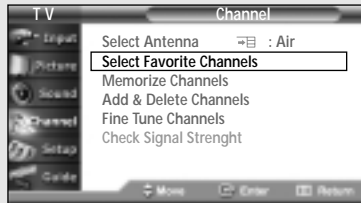

3

Press the **▲** or **▼** button to select the channels, then press the **ENTER** button. Press the **ENTER** button again to deselect the selected channel.

To return to the previous step, move to "Return" by pressing the **▶** button and then press the **ENTER** button.

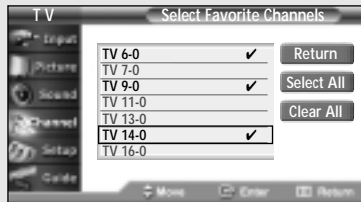

◀ Note: Only memorized channels can be set as Favorite channels.

◀ Select All :
Press to select all channels.
Clear All :
Press to clear all channels.

To View Your Favorite Channels:

Press the **FAV.CH** button repeatedly to jump from one favorite channel to another.

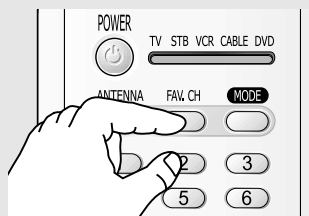

OPERATION

Adding and Erasing Channels

To add channels that were not memorized (or to delete unwanted channels from memory):

1

Use the number buttons to directly select the channel that will be added or erased.

Press the ▼ button to select "Channel", then press the **ENTER** button.

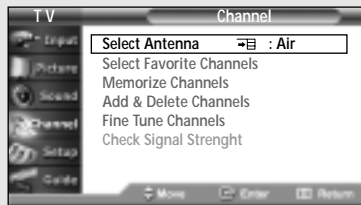

2

Press the ▼ button to select "Add & Delete Channels", then press the **ENTER** button.



3

Repeatedly pressing **ENTER** will alternate between Add channel and Delete channel.

Press the number buttons (or **CH ▲▼** buttons) to switch to the appropriate channel, and then repeat step 4. Press **ENTER**.

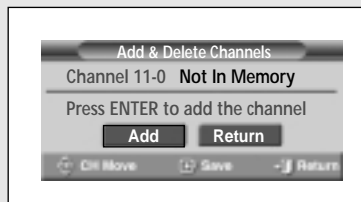

<Add channel>

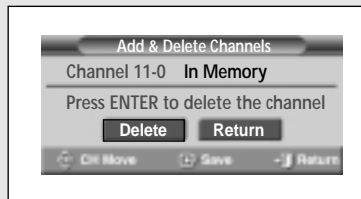

<Delete channel>

OPERATION

Picture Control

You can use the on-screen menus to change the contrast, brightness, tint, color, and sharpness according to personal preference. (Alternatively, you can use one of the “automatic” settings. See next page.)

Customizing the Picture

1

Press the **MENU** button.

Press the **▼** button to select “Picture”, then press the **ENTER** button.

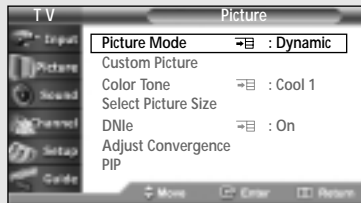

2

Press the **▼** button to select “Custom Picture”, then press the **ENTER** button. (The items Contrast, Brightness, Sharpness, Color, and Tint will appear on the screen.)

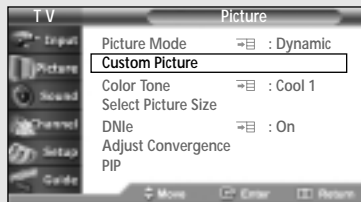

3

Press the **▲** or **▼** button to select a particular item.

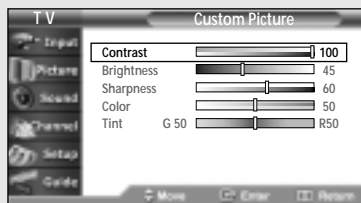

4

Press the **▶** or **◀** button to increase or decrease the value of a particular item.

Press the **EXIT** button to exit.



OPERATION

Using Automatic Picture Settings

Your TV has three automatic picture settings (“Dynamic”, “Standard”, “Movie” and “Custom”) that are preset at the factory. You can activate either Dynamic, Standard or Movie by pressing P.Mode (or by making a selection from the menu). Or, you can select “Custom” which automatically recalls your personalized picture settings.

1

Press the **MENU** button.

Press the **▼** button to select “Picture”, then press the **ENTER** button.

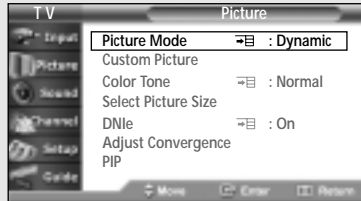

2

Press the **ENTER** button to select “Picture Mode”.

Press the **▲** or **▼** button to select the “Dynamic” “Standard” “Movie” or “Custom” picture setting.

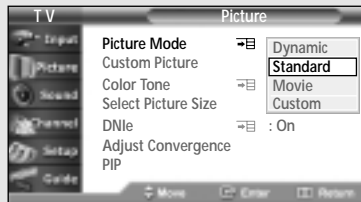

Alternate method:
Simply press the **P.Mode** button on the remote control to select one of the standard picture settings.



- Choose *Dynamic* for viewing the TV during the day or when there is bright light in the room.
- Choose *Standard* for the standard factory settings.
- Choose *Movie* when viewing the Movie.
- Choose *Custom* if you want to adjust the settings according to personal preference (see “Customizing the Picture, page 39).

OPERATION

Selecting the Color Tone

1

Press the **MENU** button.

Press the **▼** button to select "Picture", then press the **ENTER** button.

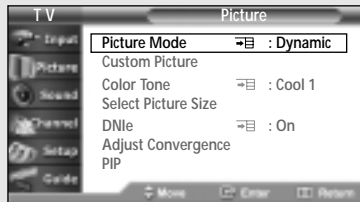

2

Press the **▼** button to select "Color Tone", then press the **ENTER** button.

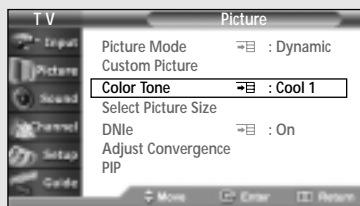

3

Press the **▲** or **▼** button to select "Cool2", "Cool1", "Normal" or "Warm1", "Warm2"

Press the **EXIT** button to exit.

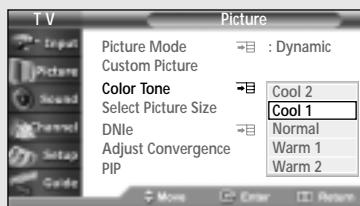

Sound Control

Adjusting the Volume

Press the **VOL +** or **VOL -** buttons to increase or decrease the volume.

Using Mute

At any time, you can temporarily cut off the sound using the Mute button.

1

Press the **MUTE** button and the sound cuts off. The word "MUTE" will appear in the lower-left corner of the screen.



2

To turn mute off, press either the **VOL -** or **VOL +** button.

Customizing the Sound

The sound settings can be adjusted to suit your personal preferences. (Alternatively, you can use one of the "automatic" settings. See next page.)

1

Press the **MENU** button.

Press the **▼** button to select "Sound", then press the **ENTER** button.

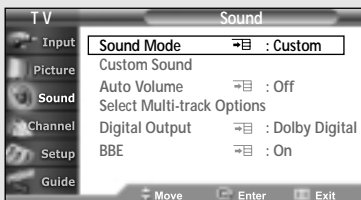

2

Press the **▼** button to select "Custom Sound", then press the **ENTER** button.

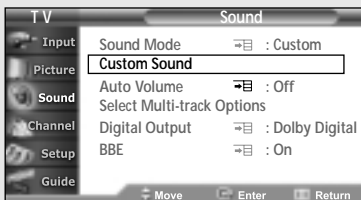

OPERATION

3

Press the ► or ◀ button to highlight a particular item to be changed.

Press the ▲ or ▼ button to increase or decrease the value of a particular item.

Press the EXIT button to exit.



Using Automatic Sound Settings

Your TV has four automatic sound settings (“Standard”, “Music”, “Movie”, and “Speech”) that are preset at the factory. You can activate either Standard, Music, Movie or Speech by pressing the S.MODE button (or by making a selection from the menu). Or, you can select “Custom,” which automatically recalls your personalized sound settings.

1

Press the **ENTER** button.

Press the ▼ button to select “Sound”, then press the **ENTER** button.

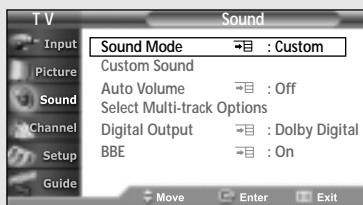

2

Press the **ENTER** button, then press the ▲ or ▼ button to select “Standard,” “Music,” “Movie,” “Speech” or “Custom” sound settings.

Press the **EXIT** button to exit.

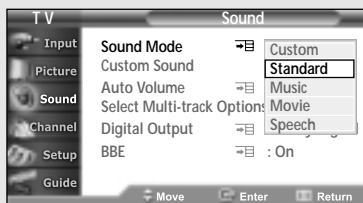

Alternate method:

Simply press the **S.MODE** button on the remote control to select one of the standard sound settings.



- Choose *Standard* for the standard factory settings.
- Choose *Music* when watching music videos or concerts.
- Choose *Movie* when watching movies.
- Choose *Speech* when watching a show that is mostly dialogue (i.e., news).
- Choose *Custom* to recall your personalized settings.

Setting the Clock

Setting the clock is necessary in order to use the various timer features of the TV. Also, you can check the time while watching the TV. (Just press Display.)

Option 1: Setting the Clock Manually

1

Press the MENU button.

Press the ▼ button to select "Setup", then press the ENTER button.

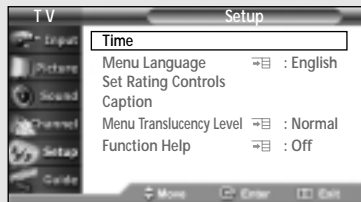

2

Press the ENTER button, then press the ▼ button to select "Manual". Press the ENTER button.

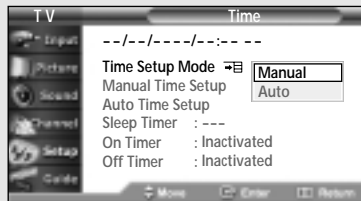

3

Press the ▼ button to select "Manual Time Setup", then press the ENTER button.

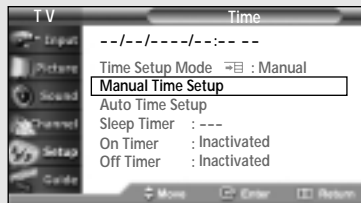

4

Move to 'Month' by pressing the ► or ◀ button, and then set the month you want by pressing the ▲ or ▼ button. Press the ENTER button to move to the next step. Set other items using the same method as listed above. Press the ENTER button twice.

Press the EXIT button to exit.

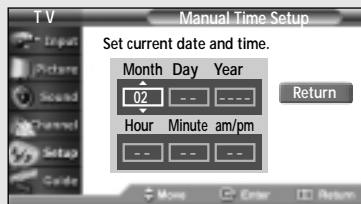

◀ The time will appear every time you press the INFO button.

Notes:

- You can set the hour and minutes directly by pressing the number buttons on the remote control.
- You can view the current time by pressing the INFO button.

OPERATION

Option 2: Setting the Clock Automatically

The Clock can be set automatically if you are receiving a digital signal.

1

Press the **MENU** button.

Press the **▼** button to select "Setup", then press the **ENTER** button.

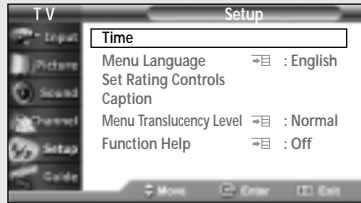

2

Press the **ENTER** button, then press the **▼** button to select "Auto". Press the **ENTER** button.

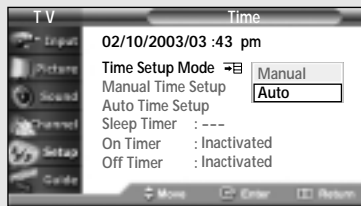

3

Press the **▼** button to select "Auto Time Setup". Press the **ENTER** button.

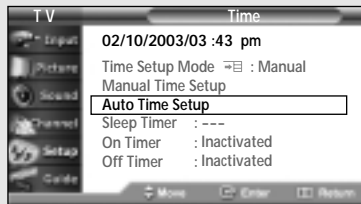

4

Press the **ENTER** button to select "Daylight Savings Time". Press the **▼** button to select "No" or "Yes", then press the **ENTER** button.



5

Press the **▼** to select "Time Zone Picture", then press the **ENTER** button.

Press the **▲** or **▼** button to highlight the time zone for your local area (and to move highlight to the appropriate time zone on the map of the United States). Press **ENTER**.

The time will be set automatically.

Press the **EXIT** button to exit.

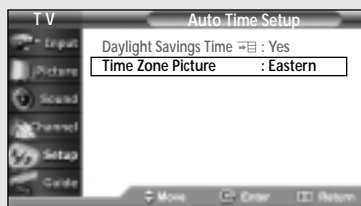

◀ The set time can be changed according to the broadcasting station and signal when you set up Auto Time.

If there is a difference between the real time and set time, please use "Manual Time Setup".

Viewing an External Signal Source

Use the remote control to switch between viewing signals from connected equipment, such as VCRs, DVD, Set-Top box and the TV source (broadcast or cable).

Setting the Signal Source

1

Press the MENU button.

Press the **ENTER** button to select "Input".



2

Press the **▲** or **▼** button to select signal source, then press the **ENTER** button



When you connect equipment to the TV, you can choose between the following sets of jacks : Video 1, Video 2, Video 3, S-Video 1, S-Video 2, Component 1, Component 2 or DVI on the TV's rear panel, and Video 3 or S-Video 2 on the TV's side panel.

Assigning Names to External input mode

1

Press the MENU button.

Press the **ENTER** button to select "Input".



2

Press the **▼** button to select "Edit Name".



OPERATION

3

Press the MENU button.

Press the **ENTER** button to select "Input".



4

Press the **ENTER** button.
Press the ▲ or ▼ button to select external device :
VCR, DVD, D-VHS, Cable STB, HD STB, Satellite STB, PVR STB, AV Receiver, DVD Receiver, Game, Camcorder, Combo, PC, VOD STB, TV.

Set other signal sources (Video2, Video3, S-Video1, S-Video2, Component1, Component2, DVI) using the same method as listed above.

Press the **ENTER** button

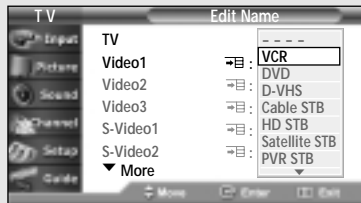

Chapter Four

SPECIAL FEATURES

Analog Fine Tuning Analog Channels

The Fine Tuning function lets you manually adjust the TV's tuner if you have difficulty tuning analog channels.

1

Press the **MENU** button.

Press the **▼** button to select "Channel", then press the **ENTER** button.

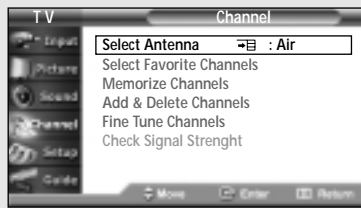

2

Press the **▼** button to select "Fine Tune Channels (Analog)", then press the **ENTER** button.

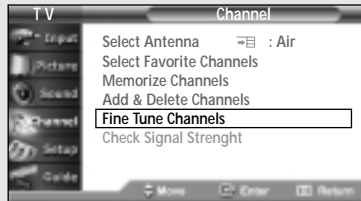

3

Press the **▶** or **◀** button to adjust the fine tuning.

To store the fine tuning setting in the TV's memory, press the **ENTER** button.

To reset the fine tuning to "0", press the **▼** button to select "Reset".

To reset the adjusted values, move to "Reset" by pressing the **▼** button and then press the **ENTER** button.

Press the **EXIT** button exit.



Note

- Only analog TV channels can be fine tuned.

Digital Checking the Digital-Signal Strength

Unlike analog channels, which can vary in reception quality from “snowy” to clear, digital (HDTV) channels have either perfect reception quality or you will not receive them at all. So, unlike analog channels, you cannot fine tune a digital channel. You can, however, adjust your antenna to improve the reception of available digital channels.

1

Press the **MENU** button.

Press the **▼** button to select “Channel”, then press the **ENTER** button.

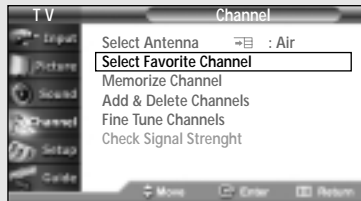

2

Press the **▼** button to select “Check Signal Strength (Digital)”, then press the **ENTER** button.

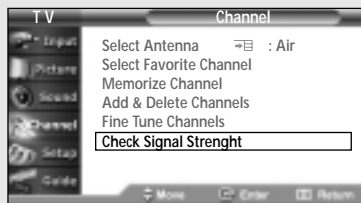

3

If the signal strength meter indicates that the signal is weak, physically adjust your antenna to increase the signal strength. Continue to adjust the antenna until you find the best position with the strongest signal.

Press the **MENU** button return.

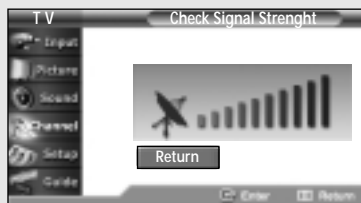

Note

- “No Signal” may appear on the screen depending on the broadcasting station conditions, even though an incoming broadcast signal exists.

Changing the Screen Size

1
Press the **MENU** button.

Press the **▼** button to select "Picture", then press the **ENTER** button.

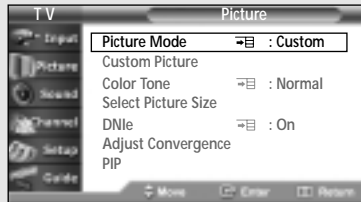

◀ Quick way to change the Screen size: Simply press the "ASPECT" button on the remote control.

2
Press the **▼** button to select "Select Picture Size", then press the **ENTER** button.

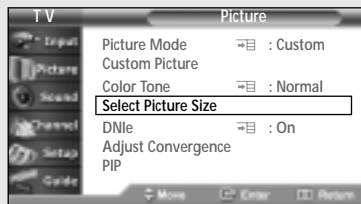

3
Press the **▶** or **◀** button to highlight the screen format you want.

Press the **EXIT** button to exit.

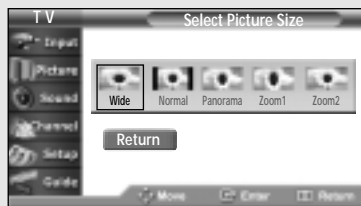

◀ You can also exit using this method: Move to "Return" by pressing the **▼** button and then press the **ENTER** button.

- **Wide:** Sets the picture to 16:9 wide mode.
- **Normal :** Sets the picture to 4:3 normal mode.
- **Panorama:** Use this mode for the wide aspect ratio of a panoramic picture.
- **Zoom 1:** Magnifies the size of the picture on the screen. You can also move the picture on screen pressing the **▲/▼** buttons.
- **Zoom 2:** Expands the Zoom 1 format picture. You can also move the picture on screen pressing the **▲/▼** buttons.

Note

- Changing the Screen Format feature availability depends on the current broadcasting signal format.
- Analog signal : Wide → Normal → Panorama → Zoom1 → Zoom2
- Digital signal : Wide → Normal

SPECIAL FEATURES

DNiE (Digital Natural Image engine)

Samsung's New Technology brings you more detailed images with contrast, white enhancement and 3D noise reduction.

1

Press the **MENU** button.

Press the **▼** button to select "Picture", then press the **ENTER** button.

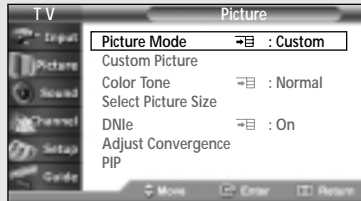

◀ Quick way to select DNiE :
Simply press the "DNiE" button on
the remote control:

2

Press the **▼** button to select "DNiE", then press the **ENTER** button. Press the **▼** button to select "On", "Off" or "Demo".

Press the **EXIT** button to exit.

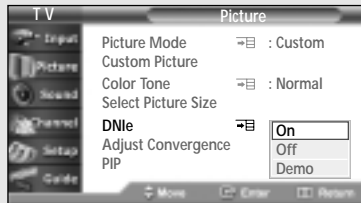

Viewing Picture-in-Picture

You can use the PIP feature to simultaneously watch two video sources.

Note: When PIP is selected in the Zoom mode, the Mode is automatically converted to the Normal mode.

Activating Picture-in-Picture

1

Press the **MENU** button.

Press the **▼** button to select "Picture", then press the **ENTER** button.

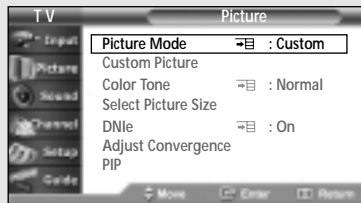

◀ Quick way to access the PIP menu: Simply press the "PIP" button on the remote control.

2

Press the **▼** button to select "PIP", then press the **ENTER** button.

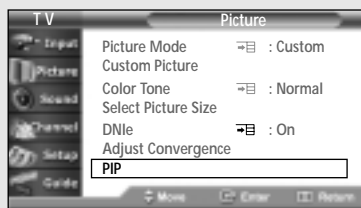

◀ If you turn TV off while watching and turn it on again, the PIP window will disappear.

3

Press the **ENTER** button. Press the **▼** button to select "On", then press the **ENTER** button.

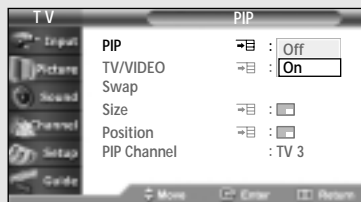

Notes

- Picture-in-Picture doesn't function when the V-chip is active.
- Screen size cannot be changed in the PIP Double Size mode.
- The PIP feature doesn't work with Component1, Component2(480p,720p,1080i) and DVI modes.
- When the cable box output is connected to ANT-B, it cannot be viewed in the PIP window.
- DIGITAL Channel does not function when changing PIP channels.

SPECIAL FEATURES

Selecting a Signal Source (External A/V) for PIP

You can use PIP to view a signal from an external source, such as a VCR.

1

Press the **MENU** button.

Press the **▼** button to select "Picture", then press the **ENTER** button.

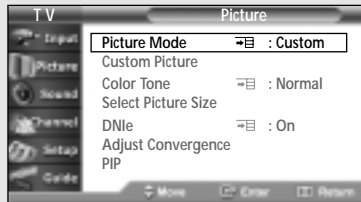

2

Press the **▼** button to select "PIP", then press the **ENTER** button.

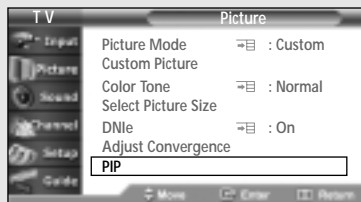

3

Press the **▼** button to select "TV/VIDEO", then press the **ENTER** button. Press the **▲** or **▼** button to select the signal source.

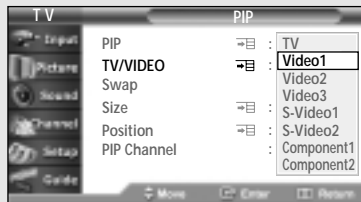

The signal from these inputs will not appear if you have not connected any equipment to the input jacks.

Press the **EXIT** button to exit.

SPECIAL FEATURES

Swapping the Contents of the PIP Image and Main Image

1

Press the **MENU** button.

Press the **▼** button to select "Picture", then press the **ENTER** button.

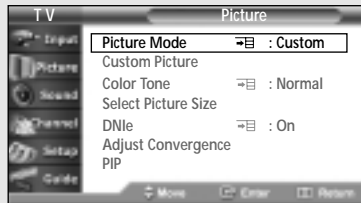

2

Press the **▼** button to select "PIP", then press the **ENTER** button.

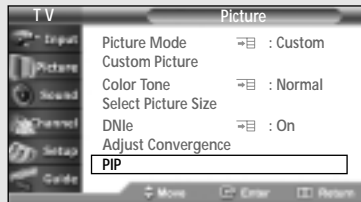

3

Press the **▼** button to select "Swap", then press the **ENTER** button.

The image in the PIP window will appear on the main screen, and vice versa.

Press the **EXIT** button to exit.

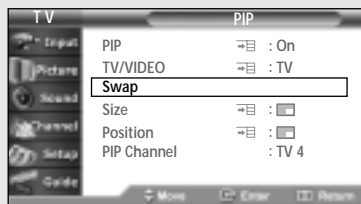

Notes:

- When ANT-B is selected, the PIP Swap function doesn't work.
- When main image is selected to DTV, Component (480p/720p/1080i) or DVI mode, the PIP Swap function doesn't work.

SPECIAL FEATURES

Changing the Size of the PIP Window

1

Press the **MENU** button.

Press the **▼** button to select "Picture", then press the **ENTER** button.

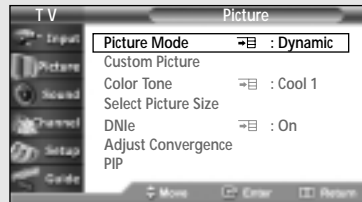

2

Press the **▼** button to select "PIP", then press the **ENTER** button.

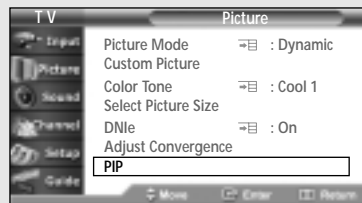

3

Press the **▼** button to select "Size", then press the **ENTER** button.

Press the **▲** or **▼** button to select the PIP size, then press the **ENTER** button.

Press the **EXIT** button to exit.

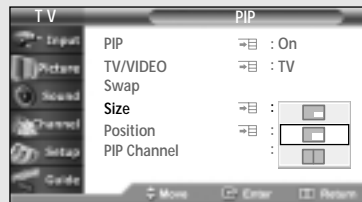

SPECIAL FEATURES

Changing the Position of the PIP

1

Press the **MENU** button.

Press the **▼** button to select "Picture", then press the **ENTER** button.

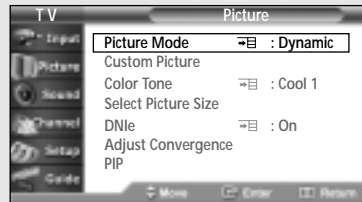

2

Press the **▼** button to select "PIP", then press the **ENTER** button.

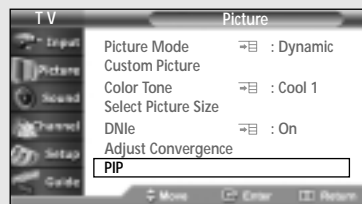

3

Press the **▼** button to select "Position", then press the **ENTER** button.

Press the **▲** or **▼** button to position the PIP screen where you want, then press the **ENTER** button.

Press the **EXIT** button to exit.

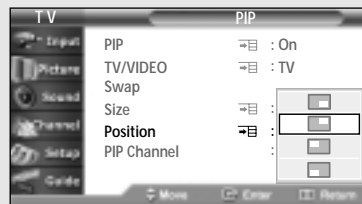

SPECIAL FEATURES

Changing the PIP Channel

1

Press the **MENU** button.

Press the **▼** button to select "Picture", then press the **ENTER** button.

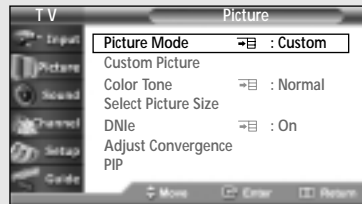

◀ Quick way to access PIP CH: Simply press the (PIP) "CH ▲▼" button on the remote control.

2

Press the **▼** button to select "PIP", then press the **ENTER** button.

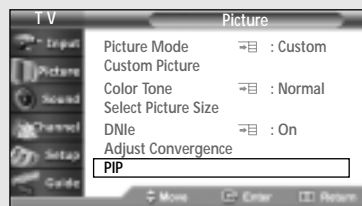

3

Press the **▼** button to select "PIP Channel", then press the **ENTER** button.

Press the **▲** or **▼** button to change the channel that appears in the PIP window. You can also press PIP CH **▼**, **▲** buttons on the remote control

Press the **EXIT** button to exit.

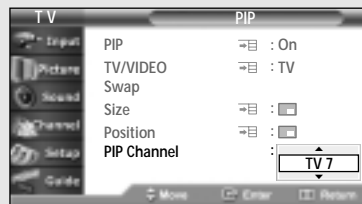

Note: The PIP channels are not available when RF is set to ANT-B. (The PIP channels link to ANT-A).

Extra sound settings (Auto Volume, BBE)

Auto Volume

Each broadcasting station has its own signal conditions, which can make it necessary to adjust the volume every time the channel is changed. "Auto volume" lets you automatically adjust the volume of the desired channel by lowering the sound output when the modulation signal is high or by raising the sound output when the modulation signal is low.

1

Press the **MENU** button.

Press the **▼** button to select "Sound", then press the **ENTER** button.

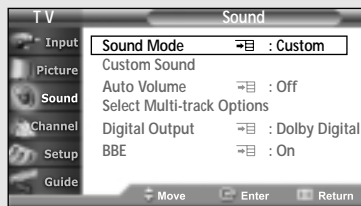

2

Press the **▼** button to select "Auto Volume", then press the **ENTER** button.

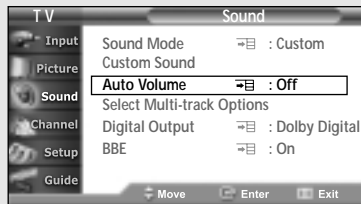

3

Press the **▼** button to select "On".

Press the **EXIT** button to exit

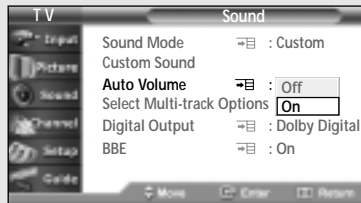

SPECIAL FEATURES

BBE

BBE is a built-in effect that adds clarity, punch and dynamics to the sound.

1

Press the **MENU** button.

Press the **▼** button to select "Sound", then press the **ENTER** button.

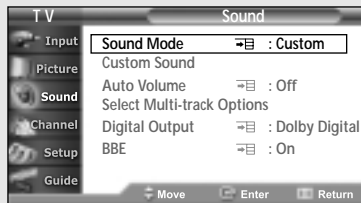

◀ Quick way to select BBE:
Simply press the "BBE" button on
the remote control:

2

Press the **▼** button to select "Auto Volume" or "BBE", then press the **ENTER** button.

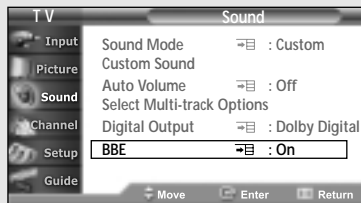

3

Press the **▼** button to select "On".

Press the **EXIT** button to exit.

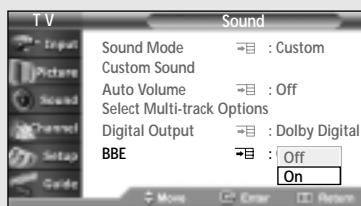

Digital Choosing a Multi-Channel Sound (MTS) Soundtrack

When a Digital Signal is received

The digital-TV transmission system is capable of simultaneous transmission of many audio tracks (for example, simultaneous translations of the program into foreign languages). The availability of these additional “multitracks” depends upon the program.

- 1**
Press the **MENU** button.

Press the **▼** button to select “Sound”, then press the **ENTER** button.

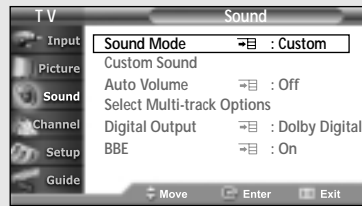

◀ Quick way to access the MTS menu: Just press the “MTS” button on the remote control.
You can listen in a language other than the favorite language by pressing the MTS button.

- 2**
Press the **▼** button to select “Select Multi-track Options”, then press the **ENTER** button.

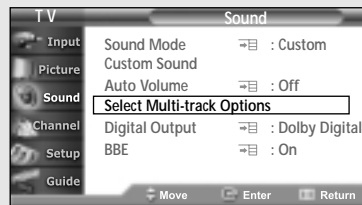

◀ The text at the bottom of the menu tells you if the incoming audio is Spanish, French or English.

- 3**
Press the **▲** or **▼** button to choose the language (English, Spanish, French) you want.
Press the **ENTER** button.



Press the **EXIT** button to exit

SPECIAL FEATURES

Analog When an Analog Signal is received

Depending on the particular program being broadcast, you can listen to Mono, Stereo or a SAP.

1
Press the **MENU** button.

Press the **▼** button to select "Sound", then press the **ENTER** button.

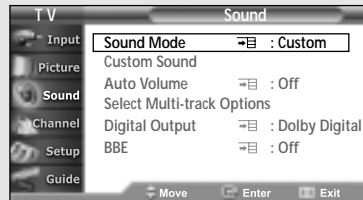

◀ Quick way to access the MTS menu: Just press the "MTS" button on the remote control.

2
Press the **▼** button to select "Select Multi-track Options", then press the **ENTER** button.

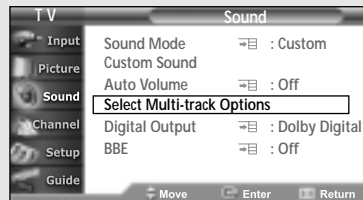

◀ The text at the bottom of the menu tells you if the incoming audio is Mono, Stereo or SAP.

3
Press the **▲** or **▼** button to select "Multi-track Sound", then press the **ENTER** button.



4
Press the **▲** or **▼** button to choose the submenu (Mono, Stereo, SAP) you want.
Press the **ENTER** button.



Press the **EXIT** button to exit

- Choose *Stereo* for channels that are broadcasting in stereo.
- Choose *Mono* for channels that are broadcasting in mono, or if you are having difficulty receiving a stereo signal.
- Choose *SAP* to listen to the Secondary Audio Program, which is usually a foreign-language translation.

SPECIAL FEATURES

Setting the On/Off Timer

1

Press the MENU button.

Press the ▼ button to select "Setup", then press the ENTER button.



2

Press the ENTER button, then press the ▼ button to select "On Timer".

Press the ENTER button.

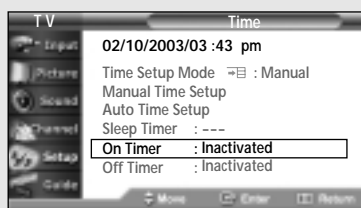

3

Press the ▲ or ▼ button to adjust "Hour", then press the ENTER button.

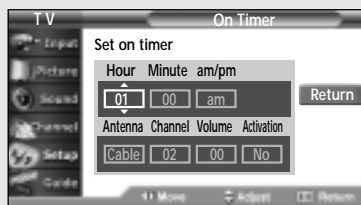

4

Press the ▲ or ▼ button to adjust "Minute", then press the ENTER button.

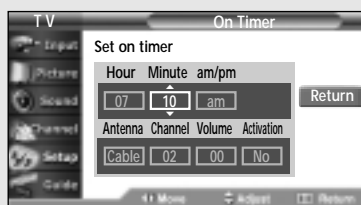

5

Press the ▲ or ▼ button to select "am" or "pm", then press the ENTER button.

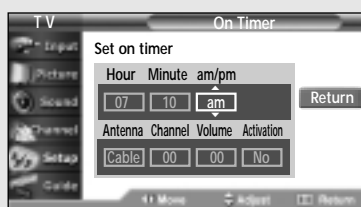

SPECIAL FEATURES

6

Press the ▲ or ▼ button to select Antenna (Cable, Air), then press the **ENTER** button.

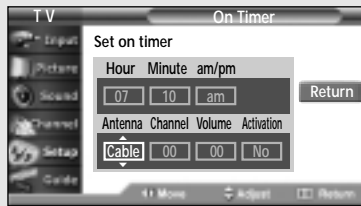

7

Press the ▲ or ▼ button to adjust "Channel", then press the **ENTER** button.

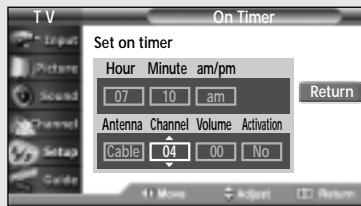

8

Press the ▲ or ▼ button to adjust "Volume", then press the **ENTER** button.

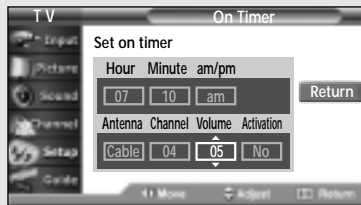

9

Press the ▲ or ▼ button to select "Activation" (Yes, No), then press the **ENTER** button.

When finished, press the **ENTER** to return.



10

Set the Off Timer, press the ▼ button to select "Off Timer", then press the **ENTER** button.

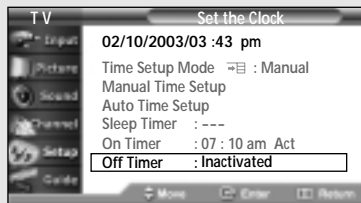

◀ If no function buttons (including remote control buttons or front panel buttons) are operated for three hours after the TV is turned on with the by the "On time" feature, TV will automatically turn off.

SPECIAL FEATURES

11

Press the ▲ or ▼ button to adjust “Hour”.
Press the **ENTER** button to move to the next step.
Set other items using the same method as listed on the previous page.

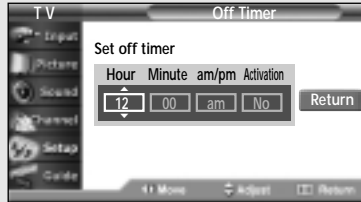

When finished setting the timer, press the **EXIT** button to exit.

Setting the Sleep Timer

The sleep timer automatically shuts off the TV after a preset time (from 10 to 180 minutes).

1

Press the **MENU** button.

Press the ▼ button to select “Setup”, then press the **ENTER** button.



2

Press the **ENTER** button.
Press the ▼ button to select “Sleep Timer”.
Press the **ENTER** button.

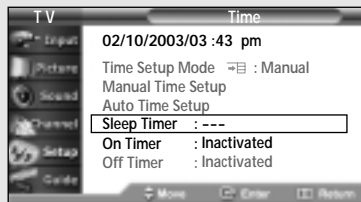

3

Press the ▲ or ▼ button to adjust to the minute you want.
Press the **ENTER** button.



4

Press the ▲ or ▼ button to select “Yes”, then press the **ENTER** button.

Press the **MENU** button to exit

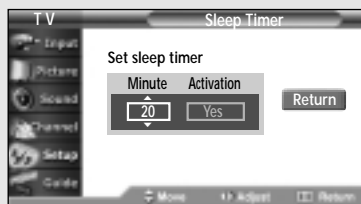

◀ Press the Sleep button on the remote control.

Press Sleep repeatedly until the appropriate time interval appears (any of the preset values from “Off” to “180”).

Rating Control Menu

Access to channels and programs is controlled by a password (i.e., a 4-digit secret code that is defined by the user). The on-screen menu will instruct you to assign a password (and you can change it later, if necessary).

How to Change Your Password

1

Press the MENU button.

Press the ▼ button to select "Setup", then press the ENTER button.

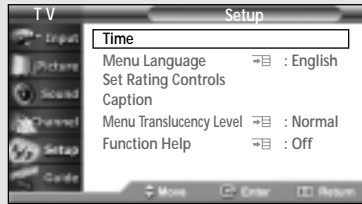

2

Press the ▼ button to select "Set Rating Controls", then press the ENTER button.



3

Press the ▼ button to select "Enter New PIN", then press the ENTER button.



4

Press the number buttons (0 – 9) on the remote control to enter your current password.

Press the number buttons (0 – 9) to enter a new password.

Re-enter the new password to confirm.

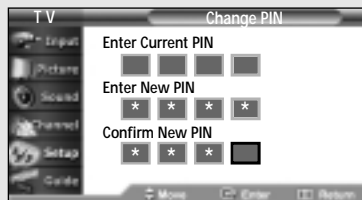
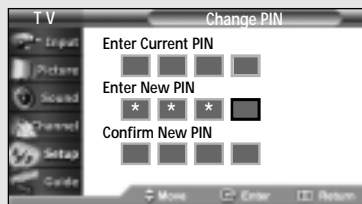

◀ Password Error:

- If you forget the password, re-do steps 1~3.
At step 4, when the display asks you to enter the current password, press the master buttons (INFO, 1, 8, and 2). Enter a new password and proceed with steps 5~6.
- The master buttons are available only in the Rating Control menu and cannot be operated during normal viewing. (If the display asks you to enter the password while blocked, the master buttons cannot be operated.)
- The Rating Control feature doesn't operate with D-VHS recordings.
- The factory default password is '0000'.

SPECIAL FEATURES

How to Set up Restrictions Using the “TV Parental Guidelines”

Parental restrictions can be set up using either of two methods: The TV guidelines or the MPAA rating.

1

Press the MENU button.

Press the ▼ button to select “Setup”, then press the ENTER button.

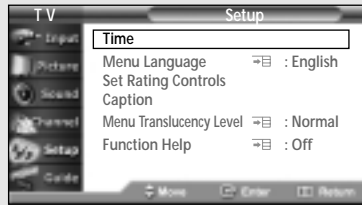

2

Press the ▼ button to select “Set Rating Controls”, then press the ENTER button.

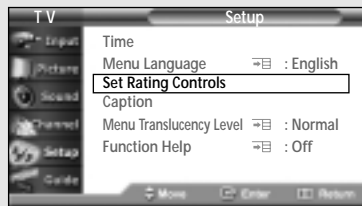

3

Enter your password correctly.



4

Press the ENTER button to select “TV Parental Guidelines”

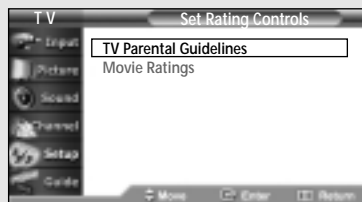

5

You can independently lock the TV ratings. The locked TV (FCC) ratings are indicated by the symbol .

Press the ▲/▼/▶/◀ buttons and the ENTER button to activate the appropriate restrictions for TV (FCC) rating system.

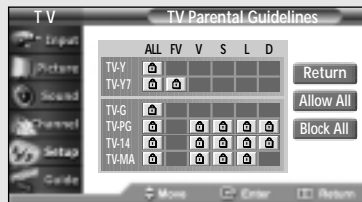

TV-Y	Young children
TV-Y7	Children 7 and over

TV-G	General audience
TV-PG	Parent Guidance
TV-14	Viewers 14 and over
TV-MA	Mature audience

◀ Note: These categories consist of two separate groups: TV-Y and TV-Y7 (young children through age 7), and TV-G through TV-MA (everybody else).

The restrictions for these two groups work independently: If a household includes very young children as well as young adults, the TV guidelines must be set up separately for each age group. (See next step.)

SPECIAL FEATURES

How to Set up Restrictions using the Movie Ratings: G, PG, PG-13, R, NC-17, X

The Movie rating system uses the Motion Picture Association of America (MPAA) system, and its main application is for movies.

When the Rating Controls is on, the TV will automatically block any programs that are coded with objectionable ratings (either MPAA or TV-Ratings).

1

Press the MENU button.

Press the ▼ button to select "Setup", then press the ENTER button.



2

Press the ▼ button to select "Set Rating Controls", then press the ENTER button.



3

Enter your password correctly.



4

Press the ENTER button to select "Movie Ratings"

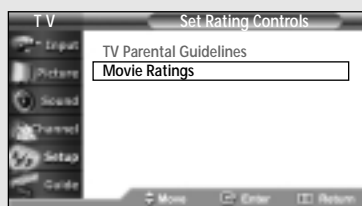

5

You can independently lock the Movie ratings. The locked Movie ratings are indicated by the symbol .

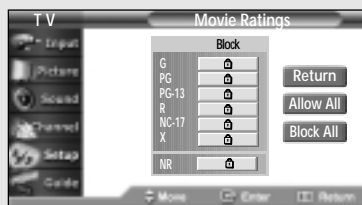

Press the ▲/▼/▶/◀ buttons and the ENTER button to activate the appropriate restrictions for Movie rating system.

SPECIAL FEATURES

Important Notes About Parental Locks

Explanation of the MPAA and TV (FCC) Rating Systems:

TV (FCC) Age-Based Ratings

TV-MA

Mature audiences only. This program may contain mature themes, profane language, graphic violence and explicit sexual content.

TV-14

Parents strongly cautioned. This program may contain sophisticated themes, sexual content, strong language and more intense violence.

TV-PG

Parental guidance suggested. The program may contain infrequent coarse language, limited violence, some suggestive sexual dialogue and situations.

TV-G

General audience. It contains little or no violence, no strong language, and little or no sexual dialogue or situations.

TV-Y7

Directed to older children. Themes and elements in this program may include mild physical or comedic violence, or may frighten children under the age of seven.

TV-Y

All children. The themes and elements in this program are specifically designed for a very young audience, including children from ages two – six.

TV (FCC) Content Category

V	Violence.
S	Sexual content.
L	Offensive language.
D	Dialogue...sexual innuendo.
FV	Fantasy or cartoon violence.

MPAA Rating System (Movies)

G	General audience. No restriction.
PG	Children under 13 should be accompanied by an adult.
PG-13	Parental guidance suggested. Children under 13 should be accompanied by an adult.
R	Restricted. Viewers should be 17 or older.
NC-17	Not classified. Viewers should be 17 or older.
X	Adults only.

- TV (FCC) ratings: The particular rating that you have selected will be locked (and indicated as a red "L" on a blue background). Also, all of the age-based ratings will be locked within the particular group (i.e., "group 1" or "group 2").
Suppose that the TV-G rating and all of its contents (V, S, L, and D) are locked. In that case, more restrictive ratings (TV-PG, TV-14, and TV-MA) and all of their contents (V, S, L, and D) are automatically locked as well.
- MPAA ratings: The particular rating that you have selected will be locked. In addition, more restrictive ratings will be locked as well.
- Neither TV (FCC) ratings nor MPAA ratings apply to news programs.

Digital Viewing Closed Captions

Setting Up Digital Captions (On-Screen Text Messages)

The Digital Captions function operates on digital channels.

◀ Quick way to access captions menu: Simply press the "Caption" button on the remote control:

1

Press the MENU button.

Press the ▼ button to select "Setup", then press the ENTER button.



2

Press the ▼ button to select "Captions", then press the ENTER button.

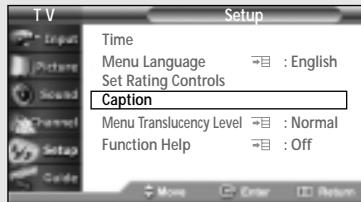

3

Press the ENTER button. Press the ▼ button to select "On", then press the ENTER button.



4

Press the ▼ button to select "Digital Caption Options", then press the ENTER button.

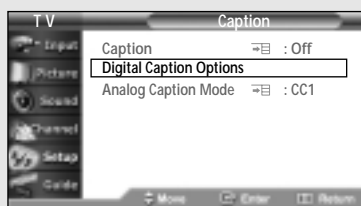

SPECIAL FEATURES

5

Press the ▲, ▼ button to select the option (Service, Size, Style, Foreground or Background) you want.

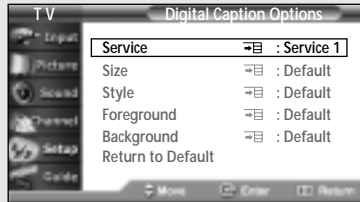

Service :

This option consists of Service 1 - Service6. The default is Service 1. Either the reading level or the language may change depending on the service option.

Size :

This option consists of Default, Small, Standard, Large. The default is Standard.

Style:

This option consists of Default, Style0 ~ Style 7. You can change the font you want. The default is Style 0.

Foreground:

This option consists of Default, White, Black, Red, Green, Blue, Yellow, Magenta, Cyan. You can change the color of the letter. The default is White.

Background:

This option consists of Default, White, Black, Red, Green, Blue, Yellow, Magenta, Cyan. You can change the background color of the caption. The default is Black.

Return to Default :

This option sets each of Service, Size, Style, Foreground, Background to its default.

Notes:

- The availability of captions depends on the program being broadcast.
- For other channels, which don't operate with the Digital Captions feature, each press of the CAPTION button will alternate among CC1, CC2, CC3, CC4, and OFF
 - *CC1; The Primary Synchronous Caption Service. These are captions in the primary language that must be in sync with the sound, preferably matched to a specific frame.
 - *CC2; The Special Non-Synchronous Use Captions. This channel carries data that is intended to augment information carried in the program.
 - *CC3; Secondary Synchronous Caption Service. Alternate program-related caption data, typically second language captions.
 - *CC4; Special Non-Synchronous Use Captions. Similar to CC2.

Analog Viewing Closed Caption

Setting Up Analog Caption (On-Screen Text Messages)

The Analog Caption function operates in either analog RF channel mode or external signal mode. (Depending on the broadcasting signal, the Analog Caption function may operate on digital channels.)

◀ Quick way to access captions menu: Simply press the “Caption” button on the remote control:

1

Press the **MENU** button.

Press the **▼** button to select “Setup”, then press the **ENTER** button.



2

Press the **▼** button to select “Caption”, then press the **ENTER** button.

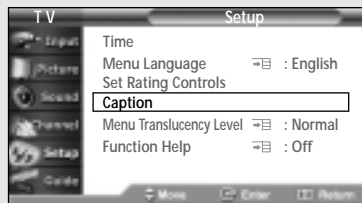

3

Press the **ENTER** button. Press the **▼** button to select “On”, then press the **ENTER** button.



4

Press the **▼** button to select “Analog Caption Mode”, then press the **ENTER** button. Press the **▲** or **▼** button to select submenu (CC1, CC2, CC3, CC4) you want.

Press the **MENU** button to exit



Notes:

- The Caption feature doesn't work in DVI mode.
- The availability of captions depends on the program being broadcast.
- You can also alternate among CC1, CC2, CC3 or CC4 by pressing the CAPTION button on the remote control.

SPECIAL FEATURES

Menu Translucency Level

Adjusts the transparency of the menu screen.

1

Press the MENU button.

Press the ▼ button to select "Setup", then press the ENTER button.

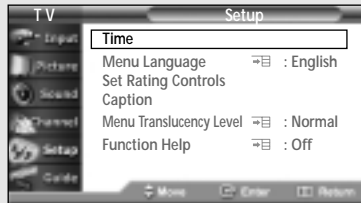

2

Press the ▼ button to select "Menu Translucency Level", then press the ENTER button.

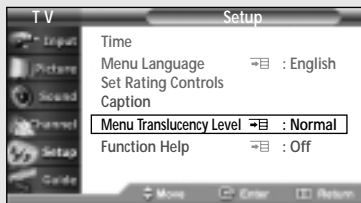

3

Press the ▼ button to select level, then press the ENTER button.

Press the EXIT button to exit.



SPECIAL FEATURES

Setting the Function Help

Displays help on the menu functions.

1

Press the MENU button.

Press the ▼ button to select "Setup", then press the ENTER button.

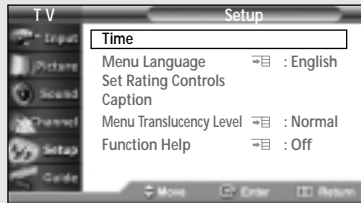

2

Press the ▼ button to select "Function Help", then press the ENTER button.

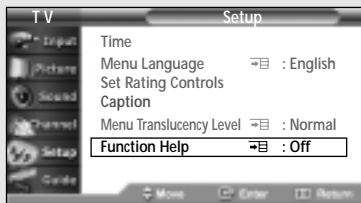

3

Press the ▼ button to select "On", then press the ENTER button.

Press the EXIT button to exit.



Digital Electronic Program Guide

Your TV has an “Electronic Program Guide” to help you navigate through all the possible viewing options. The EPG supplies information, such as program lists, start and end times of all available channels.

In addition, detailed information about the program is often available in the EPG. (The availability and the amount of program details will vary depending on the broadcaster.)

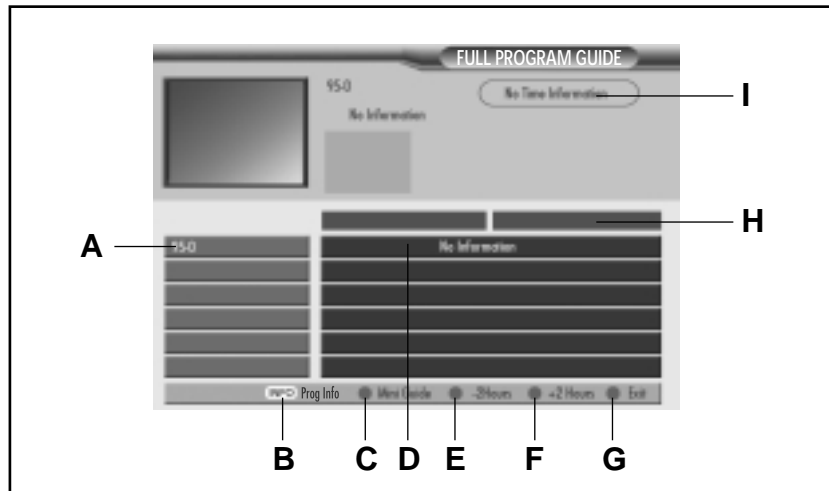

Viewing the Electronic Program Guide

- | | |
|-----------------------------------------------------------------------------------------------------------------------------------------------------------------------------------------------------------------------------------------------------------------------------------------------------------------------------------------------------------------------------------------------------------------------------------------------------------------------------------------------------------------------------------------------------------------------------------------------------------------------------------------------------------------------------------------------------------------------|-----------------------------------------------------------------------------------------------------------------------------------------------------------------------------------------------------------------------------------------------------------------------------------------------------------------------------------------------------------------------------------------------------------------------------------------------------------------------------------------------------------------------------------------------------------------------------|
| <p>A Displays which channel is currently selected to show program information in the Channel Guide.</p> <p>B Press to view detailed information for the selected digital program.</p> <p>C Switches to the mini program guide. The mini guide shows the titles of the available programs of one channel. Press the Red button on the remote control. The set default guide is Mini Guide.</p> <p>D Scrolls backwards quickly (2 hours). Press the Green button on the remote control.</p> <p>E Displays titles and other details about upcoming programs of particular channels. Highlight the program and press INFO. to see additional and detailed information. (The avail-</p> | <p>ability of additional details depends on the broadcaster.) Use the Menu ▲, ▼ buttons to search information about another channel.</p> <p>F Scrolls forward quickly (2 hours). Press the Yellow button on the remote control and repeatedly press ENTER until the appropriate time is displayed.</p> <p>G Exits from the Program Guide and returns to normal viewing mode. Press the Blue button on the remote control.</p> <p>H Displays the program times (arranged in 1 hour time blocks)</p> <p>I Displays the current time and date.</p> |
|-----------------------------------------------------------------------------------------------------------------------------------------------------------------------------------------------------------------------------------------------------------------------------------------------------------------------------------------------------------------------------------------------------------------------------------------------------------------------------------------------------------------------------------------------------------------------------------------------------------------------------------------------------------------------------------------------------------------------|-----------------------------------------------------------------------------------------------------------------------------------------------------------------------------------------------------------------------------------------------------------------------------------------------------------------------------------------------------------------------------------------------------------------------------------------------------------------------------------------------------------------------------------------------------------------------------|

Note:

You can use the Guide button on the remote control to display the Electronic Program Guide. The EPG begins its list with the channel that is currently active. The EPG will only work when you are receiving digital channels.

SPECIAL FEATURES

Using the Electronic Program Guide

1

Press the MENU button.

Press the ▼ button to select "Guide", then press the ENTER button.

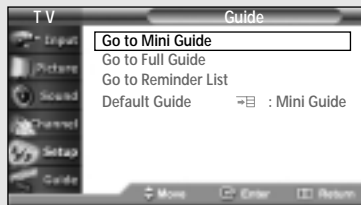

2

Press the ▼ button to select "Default Guide", then press the ENTER button.

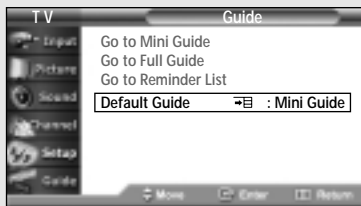

3

Press the ▼ button to select "Mini Guide" or "Full Guide", then press the ENTER button.

Press the EXIT button to exit.

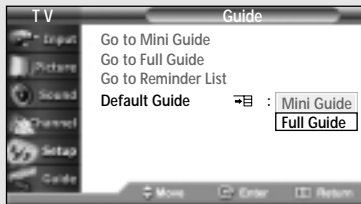

Mini Guide:

Displays the guide for one channel.

Full Guide:

Displays the guide for all channels.

SPECIAL FEATURES

Viewing Information about a Single Channel

1

Press the MENU button.

Press the ▼ button to select "Guide", then press the ENTER button.

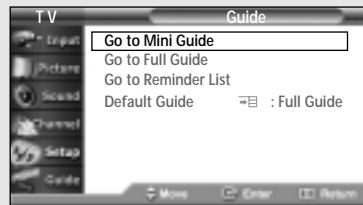

2

Press the ▼ button to select "Go to Mini Guide", then press the ENTER button.

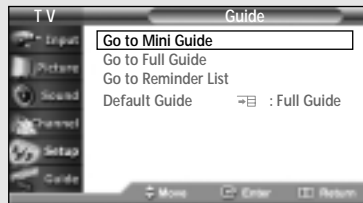

3

Press the ▼ button to select "Mini Guide" or "Full Guide", then press the ENTER button.

Press the ▲/▼ buttons to view information about one channel by time.

You can switch between Full Guide mode and Mini Guide mode by pressing the Red button repeatedly.

Select the program you want by pressing the ▲/▼ buttons and press the INFO button on the remote control.



ENTER button:

Press the ENTER button to watch the selected channel.

Red button:

Press the Red button to switch to the program guide for all channels. Press the Red button again to switch to the program information for the selected channel.

Blue button:

Press the Blue button to exit.

Green button:

Press the Green button to move to the previous page.

Yellow button:

Press the Yellow button to move to the next page.

INFO button:

Press to view detailed information for the selected digital program.

4

Press the Blue button or EXIT button to exit.

Notes:

- You can also view information about a single channel by pressing the GUIDE button on the remote control. (The EPG should be pre-set in Mini Guide mode.)
- Press the INFO button on the remote control to view the program information for the current channel.
- However, this function is available only when the default program guide setting has been set to "Current Program Guide".

SPECIAL FEATURES

Viewing Information about Channels

Displays the program time and content for all channels. This function is available only when the program is digital.

1

Press the MENU button.

Press the ▼ button to select "Guide", then press the ENTER button.

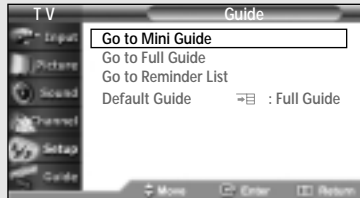

2

Press the ▼ button to select "Go to Full Guide", then press the ENTER button.

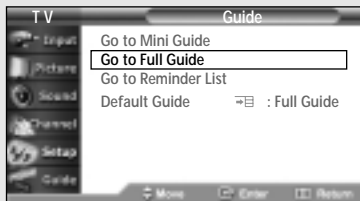

3

Press the Green button to activate "-2 Hours" and the Yellow button to activate "+2 Hours".

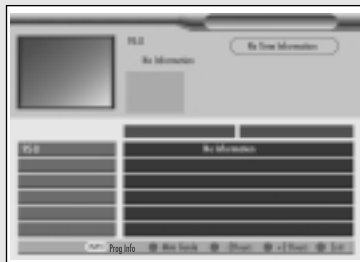

4

You may now:

- Jump to a channel directly: Use the ▲/▼ buttons to highlight the program in the ► column and press ENTER.
- Obtain additional program details: Highlight the title of a program using the ▲/▼/►/◄ buttons and press the INFO button.
- Exit from the Program Guide and return to normal viewing mode: Press Blue button or the EXIT button.

Notes:

- Displays the program times in two hour segments.
- Displays the current date and time on the top right of the screen.
- The current time displayed on the program information is subject to the time information sent from the broadcasting station, so it may differ from the actual time.
- Press the GUIDE button on the remote control to view the program information for all channels. However, this function is available only when the default program guide setting is set to "All Program Guide".

INFO button:

Displays detailed information for the selected digital program.

▲/▼ button:

Displays program information for each channel, based on the time. Select your desired program using the Up/Down button, and then press the ENTER button to view the program information for the selected program.

Red button:

Each press of the Red button switches between program information for one channel and all channels.

Green button:

Press the Green button to view the program information from two hours ago.

Yellow button:

Press the Yellow button to view the program information for two hours from now.

Blue button:

Press the Blue button to exit.

Reminder List

Reminded Viewing List

If you have made a scheduled viewing list of programs you would like to see, the channel will be automatically switched to the scheduled program at the scheduled time even if you are watching another program.

1

First, select the channel you want to add to your list. Press the **MENU** button.

Press the **▼** button to select "Guide", then press the **ENTER** button.

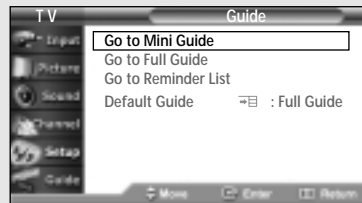

2

Press the **▼** button to select "Go to Mini Guide", then press the **ENTER** button.



3

Press the **▼** button to select programs you would like to see, then press the **ENTER** button. The symbol "✓" will be displayed. Each press of the **ENTER** button will switch between "Reminded" and "Clear".

Press the **EXIT** button to exit.

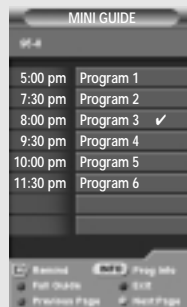

SPECIAL FEATURES

To view the Reminder List

1

First, select the channel you want to add to your list. Press the **ENTER** button.

Press the **▼** button to select "Guide", then press the **ENTER** button.



2

Press the **▼** button to select "Go to Reminder List", then press the **ENTER** button.

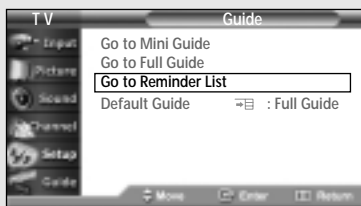

To remove all the scheduled programs

Press the **▼** button to select "Cancel All", then press the **ENTER** button. All the scheduled programs are removed.

Press the **EXIT** button to exit.



Customizing Your Remote Control

Your TV comes equipped with a “universal” remote control. In addition to controlling the TV, the universal remote can also operate most VCRs, DVDs and cable boxes (even if your VCR, Cable box or DVD are made by manufacturers other than Samsung).

Setting Up Your Remote Control to Operate Your VCR (Cable box, DVD player)

1

Turn off your VCR. (or Cable box, DVD player)

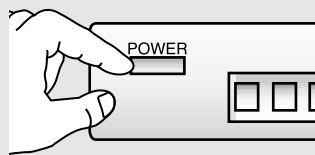

2

Press the **MODE** button to select **VCR**. (VCR mode is displayed on LED screen).

◀ The remote control has four “modes”: “TV,” “VCR,” “Cable”, “DVD”.

Press the “MODE” button to switch the remote control to the “VCR” (or DVD, CATV) mode.

3

Press the **SET** button on your TV’s remote control.

4

Enter 3 digits of the VCR (or Cable box or DVD) code listed on page 82 for your brand of VCR (or Cable box or DVD).

◀ Make sure you enter 3 digits of the code, even if the first digit is a “0.”

If more than one code listed, try the first one.

5

Press the **POWER** button on the remote control. Your VCR (or Cable box or DVD) should turn on. If your VCR (or Cable box or DVD) turns on, your remote control is now set correctly.

◀ If your VCR (or Cable box, DVD) does not turn on, repeat steps 2, 3, and 4, but try one of the other codes listed for the brand of your particular VCR (or Cable box, DVD). If no other codes are listed, try each code, 000 through 089.

6

Once your remote control is set up, press the **MODE** button any time you want to use the remote to operate your VCR (or Cable box or DVD).

◀ When your remote control is in the “VCR” (or CATV or DVD) mode, the volume buttons still control your TV’s volume.

When your remote is in the “TV” mode, the VCR control buttons (PLAY, PAUSE, etc.) will still operate your VCR.

SPECIAL FEATURES

Setting Up Your Remote Control to Operate Your Cable Box

1

Turn off your cable box.

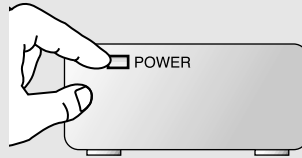

2

Press the **MODE** button to select **CATV**. (CATV mode is displayed on LED screen).

◀ The remote control has four “modes”: “TV,” “VCR,” “CABLE” and “DVD.”

Press the “MODE” button to switch the remote control to the “Cable” mode.

3

On your Samsung remote control, press **SET**.

4

Enter 3 digits of the cable box code listed below for your brand of cable box.

◀ Make sure you enter 3 digits of the code, even if the first digit is a “0.” (If more than one code listed, try the first one.)

5

Press **POWER**. Your cable box should turn on. If your cable box turns on, your remote control is now “set up” correctly.

◀ If your cable box does not turn on, repeat steps 2, 3, and 4, but try one of the other codes listed for your particular brand of cable box. (If no other codes are listed, try each cable box code, 000 through 077.)

6

Once your remote control is set up, press the **MODE** button any time you want to use the remote to operate your cable box.

◀ When your remote control is in the “CABLE” mode, the volume buttons still control your TV’s volume. Also, the VCR control buttons (PLAY, PAUSE, etc.) will still operate your VCR.

SPECIAL FEATURES

VCR Codes

000	Samsung	023	Colortyme, Curtis-Mathes, DB, Goldstar,	054	Candle, Citizen, Daewoo, Portland, Sharp
001	LG		Harman Kardon, JC Penney, JCL,	055	Candle, Citizen, Curtis-Mathes, Goldstar, JCL,
002	LG		Kenwood, Marantz, NEC		Kenwood, Marantz, NEC, Pentex, Research+
003	Daewoo	024	Aiwa, Curtis-Mathes, Dynatech, Emerson,	056	Emerson
004	Daewoo		Funai, Hitachi, Lloyd, LXI, MTC, Multitech,	057	Fisher, Sears, Toshiba
005	Daewoo		Radio Shack/Realistic: Signature, Sylvania,	058	Emerson, Scott, Toshiba
006	Daewoo		Symphonic, Tandy, Teac, Teknika	059	Pioneer
007	Daewoo, LG	025	Audio Dynamics, DB, JC Penney, JCL,	060	JC Penney
008	Daewoo		Kenwood, Marantz, NEC, Pioneer, Sansui	061	Candle, Citizen, Portland
009	Curtis-Mathes, Dimensia General, Electric Proscan, RCA	026	Akai, Shintom, Sony	062	Canon, Curtis-Mathes, General Electric, JC Penney, Magnavox, Panasonic, Philco, Radio Shack/Realistic, Sylvania
010		027	Fisher, Sears		
011	Bell & Howell, Fisher, JC Penney JCL, Kenwood, Marantz, NEC, Quartz, Radio Shack/Realistic, Sanyo, Sears, Tandy	028	Fisher, Radio Shack/Realistic, Sears, Toshiba	063	RCA
012		029	Emerson	064	Shintom
013		030	Teknika	065	Magnavox, Philco, Sylvania
014	Hitachi, JC Penney, Pentax, Pioneer, RCA, Sears, Toshiba	031	Akai, Samsung	066	Emerson
015	Admiral, Optimus, Radio Shack/ Realistic, Sharp	032	Akai, Emerson	067	Fisher
016	Candle, Citizen, Craig, Curtis-Mathes, General Electric, Go Video, JC Penney, MTC, Multitech, RCA, Samsung, Totevision	033		068	
017	Canon, Curtis-Mathes, Emerson, General Electric, Instant Replay, JC Penney, JCL, Magnavox, Marantz, Panasonic, Philco, Philips, Quasar, Radio Shack/Realistic, RCA, Sylvania, Technics, Teknika	034		069	Goldstar
018	Candle, Citizen, Emerson, Goldstar, Radio Shack/Realistic, Sears, Toshiko, Teknika, Totevision	035	Shintom, Sony	070	Marantz, NEC
019	Broksonic Emerson	036	Electrohome, Emerson, Radio Shack/Realistic, Sharp	071	Emerson
020		037	RCA	072	
021	Craig, Fisher, Radio Shack/Realistic, Sanyo, Sears	038	Magnavox, Marantz, Philco, Philips, Sylvania	073	Curtis-Mathes, NEC
022	Audio Dynamics, Candle, Citizen, Daewoo, Emerson, Samsung, Scott, Toshiba	039	JC Penney, JCL, Kenwood, Marantz, NEC, Tatung, Teac	074	Emerson
		040	Logik, Multitech, Shintom	075	
		041	General Electric, Multitech, Samsung	076	Curtis-Mathes, Emerson, TMK
		042	Pioneer	077	Emerson, Scott
		043	Emerson	078	RCA, Teac
		044	Hitachi, JC Penney, Pentax, RCA, Sears	079	Emerson
		045	Hitachi	080	
		046	RCA	081	
		047	Sony	082	KLH
		048	Sharp	083	
		049		084	Panasonic
		050	Emerson, Scott	085	Daewoo
		051	Emerson, Samsung	086	Panasonic
		052	Fisher, Radio Shack/Realistic, Sears	087	
		053	Portland, Quasar	088	Admiral

Cable Box Codes

000	Samsung	024	Oak, Osk, Sigma	052	Pioneer, Samsung, Warner, Amex
001	Nawoo	025	Tocom	053	
002	TaePyungYang	026	Pioneer	054	General, Instrument, Hitachi,
003	DeaRyung	027	Magnavox, Philips, Viewstar		Jerrold, Signature, Starcom
004	DongKuk	028	Pioneer	055	
005	DaeHan	029	Magnavox, Philips, Tocom, Viewstar	056	Hamlin
006	LG	030	Samsung	057	Tocom
007	SAEWOO	031	GI, Jerrold	058	Tocom
008	RCA	032	GI, Jerrold	059	Universal
009		033	GI, Jerrold	060	Universal
010	Regency	034	Magnavox, Philips, Viewstar	061	
011	Hamlin, Panasonic, Regal, Samsung	035	RCA, Panasonic, Sprucer	062	
012	GI, Hamlin, Jerrold	036	Magnavox, Philips, Viewstar	063	Tocom
013	GI, Jerrold	037	Magnavox, Philips, Viewstar	064	
014		038	GI, Jerrold	065	Zenith
015	Anvision, Cable Star, Eagle, Magnavox, Philips, Randtek, Viewstar	039	Unika	066	Stargate 2000
016	Anvision, Cable Star, Eagle, Magnavox, Philips, Randtek, Viewstar	040	Magnavox, Philips, Unika, Viewstar	067	Sylvania, Texscan
017	NSC	041	Magnavox, Philips, Regency, Viewstar	068	
018		042	Hamlin	069	Panasonic, Zenith
019	Sylvania, Texscan	043		070	Jerrold
020	Eastern, International, Hamlin, Regal	044	GI, Jerrold	071	Samsung
021	Hamlin, Regal	045	Hitachi, Macom	072	Samsung
022	Zenith	046	Oak	073	Jerrold
023	GI Jerrold	047	Panasonic	074	RCA
		048	Magnavox, Philips, Viewstar	075	GI
		049	Magnavox, Philips, Unika, Viewstar	076	GI
		050	Zenith	077	GI
		051	Hitachi, Macom		

DVD Codes

000	Samsung	005	Sharp
001	LG	006	Panasonic
002	Toshiba	007	Philips
003	JVC	008	RCA Proscan
004	Sony	009	CurtisMathes

Note: The remote control might not be compatible with all DVD Players, VCRs, and Cable boxes.

Chapter Five

TROUBLESHOOTING

If the TV seems to have a problem, first try this list of possible problems and solutions. If none of these troubleshooting tips apply, then call your nearest service center.

Identifying Problems

Problem	Possible Solution
Poor picture.	Try another channel. Adjust the antenna. Check all wire connections.
Poor sound quality.	Try another channel. Adjust the antenna.
No picture or sound.	Try another channel. Press the TV/Video button. Make sure the TV is plugged in. Check the antenna connections.
No color, wrong colors or tints.	Make sure the program is broadcast in color. Adjust the picture settings.
Picture rolls vertically.	Adjust the antenna. Check all wire connections.
The TV operates erratically.	Unplug the TV for 30 seconds, then try operating it again.
Your remote control does not operate your TV.	Press the "MODE" button to put your remote control in the "TV" mode.
The TV won't turn on.	Make sure the wall outlet is working.
Digital broadcasting screen problem	Please check the digital signal strength and input antenna.
Color smudge on screen.	Please operate the Perfect Focus function of Side-AV terminal on Menu.

Note

If you watch a still image or the screen in the Normal(4:3) aspect ratio format for a long time, images may be burned onto the screen.

Cleaning and Maintaining Your TV

With proper care, your TV unit will give you many years of service. Please follow these guidelines to get the maximum performance from your TV.

Placement

- Do not place the TV near extremely hot, cold, humid or dusty places.
- Do not place the TV near appliances with electric motors that create magnetic fields, such as vacuum cleaners.
- Keep the ventilation openings clear; do not place the TV on a soft surface, such as cloth or paper.
- Place the TV in a vertical position only.

Liquids

- Do not handle liquids near or on the TV. Liquids that spill into it can cause serious damage.

Cabinet

- Never open the cabinet or touch the parts inside.
- Wipe your TV with a clean, dry cloth. Never use water, cleaning fluids, wax, or chemicals.
- Do not put heavy objects on top of the cabinet.

Temperature

- If your TV is suddenly moved from a cold to a warm place, unplug the power cord, and allow at least two hours for moisture that may have formed inside the unit to dry completely.

Using Your TV in Another Country

If you plan to take your TV with you to a foreign country, please be aware of the different television systems that are in use around the world. A TV designed for one system may not work properly with another system due to differences in the TV channel frequencies

Specifications

Model	HCN479W / HCN529W / HCN559W / HCN5529W / HCN659W
Voltage	AC 120V
Frequency of Operation	60Hz
Power Consumption	240 Watts
Dimensions	<p>HCN479W: 1132 x 624 x 1325 mm ; 44.6 x 24.5 x 52.1 inches</p> <p>HCN529W: 1230 x 530 x 1393 mm ; 48.4 x 20.8 x 54.8 inches</p> <p>HCN559W: 1312 x 651 x 1435 (mm) ; 51.6 x 25.6 x 56.5 inches</p> <p>HCN5529W: 1312 x 695 x 1441 (mm) ; 51.6 x 27.3 x 56.7 inches</p> <p>HCN659W: 1529 x 736 x 1587 mm ; 60.0 x 28.9 x 62.4 inches</p>
Weight	<p>HCN479W: 76 Kg ; 167 lbs, HCN529W: 73.5 Kg ; 167 lbs,</p> <p>HCN559W : 99.5 Kg ; 219 lbs, HCN5529W : 87.8 Kg ; 192 lbs,</p> <p>HCN659W: 136 Kg ; 299 lbs</p>

Free Manuals Download Website

<http://myh66.com>

<http://usermanuals.us>

<http://www.somanuals.com>

<http://www.4manuals.cc>

<http://www.manual-lib.com>

<http://www.404manual.com>

<http://www.luxmanual.com>

<http://aubethermostatmanual.com>

Golf course search by state

<http://golfingnear.com>

Email search by domain

<http://emailbydomain.com>

Auto manuals search

<http://auto.somanuals.com>

TV manuals search

<http://tv.somanuals.com>