

SAMSUNG

**ST42W5P/ST47W3PC
ST55W3PC/ST65W3PC
ST43T8PC/ST54T8PC
ST62T8PC**

PROJECTION TELEVISION



**Owner's
Instructions**

BP68-00056B-00(ENG)

Warning! Important Safety Instructions



CAUTION: TO REDUCE THE RISK OF ELECTRIC SHOCK, DO NOT REMOVE COVER (OR BACK). NO USER SERVICEABLE PARTS INSIDE. REFER SERVICING TO QUALIFIED SERVICE PERSONNEL.

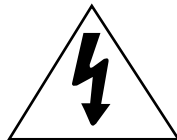

This symbol indicates high voltage is present inside. It is dangerous to make any kind of contact with any inside part of this product.



This symbol alerts you that important literature concerning operation and maintenance has been included with this product.

Note to CATV system installer: This reminder is provided to call CATV system installer's attention to Article 820-40 of the National Electrical Code (Section 54 of Canadian Electrical Code, Part I), that provides guidelines for proper grounding and, in particular, specifies that the cable ground shall be connected to the grounding system of the building as close to the point of cable entry as practical.

Caution: *FCC/CSA regulations state that any unauthorized changes or modifications to this equipment may void the user's authority to operate it.*

Caution: *To prevent electric shock, match the wide blade of plug to the wide slot, and fully insert the plug.*

Attention: *pour eviter les chocs electriques, introduire la lame le plus large de la fiche dans la borne correspondante de la prise et pousser jusqu'au fond.*

Important: One Federal Court has held that unauthorized recording of copyrighted TV programs is an infringement of U.S. copyright laws. Certain Canadian programs may also be copyrighted and any unauthorized recording in whole or in part may be in violation of these rights.

To prevent damage which may result in fire or electric shock hazard, do not expose this appliance to rain or moisture.

Thank You for Choosing Samsung

Thank you for choosing Samsung! Your new Samsung Projection TV represents the latest in television technology. We designed it with easy-to-use on-screen menus and closed captioning capabilities, making it one of the best products in its class. We are proud to offer you a product that will provide convenient, dependable service and enjoyment for years to come.

Important Safety Information

 Always be careful when using your TV receiver. To reduce the risk of fire, electrical shock, and other injuries, keep these safety precautions in mind when installing, using, and maintaining your machine.

- Read all safety and operating instructions before operating your TV.
- Keep the safety and operating instructions for future reference.
- Heed all warnings on the TV receiver and in the operating instructions.
- Follow all operating and use instructions.
- Unplug the TV receiver from the wall outlet before cleaning. Use a damp cloth; do not use liquid or aerosol cleaners.
- Never add any attachments and/or equipment without approval of the manufacturer. Such additions can increase the risk of fire, electric shock, or other personal injury.
- Do not use the TV receiver where contact with or immersion in water is a possibility, such as near bath tubs, sinks, washing machines, swimming pools, etc.
- Do not place the TV on an unstable cart, stand, tripod, bracket, or table where it can fall. A falling TV can cause serious injury to a child or adult, and serious damage to the appliance. Use only with a cart, stand, tripod, bracket, or table recommended by the manufacturer or sold with the TV. Follow the manufacturer's instructions when mounting the unit, and use a mounting accessory recommended by the manufacturer. Move the TV and cart with care. Quick stops, excessive force, and uneven surfaces can make the unit and cart unsteady and likely to overturn.
- Provide ventilation for the TV receiver. The unit is designed with slots in the cabinet for ventilation to protect it from overheating. Do not block these openings with any object, and do not place the TV receiver on a bed, sofa, rug, or other similar surface. Do not place it near a radiator or heat register. If you place the TV receiver on a rack or bookcase, ensure that there is adequate ventilation and that you've followed the manufacturer's instructions for mounting.
- Operate your TV receiver only from the type of power source indicated on the marking label. If you are not sure of the type of power supplied to your home, consult your appliance dealer or local power company.
- Use only a grounded or polarized outlet. For your safety, this TV is equipped with a polarized alternating current line plug having one blade wider than the other. This plug will fit into the power outlet only one way. If you are unable to insert the plug fully into the outlet, try reversing the plug. If the plug still does not fit, contact your electrician to replace your outlet.



- Protect the power cord. Power supply cords should be routed so that they won't be walked on or pinched by objects placed on or against them. Pay particular attention to cords at plugs, convenience receptacles, and the point where they exit from the unit.
- Unplug the TV from the wall outlet and disconnect the antenna or cable system during a lightning storm or when left unattended and unused for long periods of time. This will prevent damage to the unit due to lightning and power-line surges.
- Avoid overhead power lines. An outside antenna system should not be placed in the vicinity of overhead power lines or other electric light or power circuits or where it can fall into such power lines or circuits. When installing an outside antenna system, be extremely careful to keep from touching the power lines or circuits. Contact with such lines can be fatal.
- Do not overload the wall outlet or extension cords. Overloading can result in fire or electric shock.
- Do not insert anything through the openings in the unit, where they can touch dangerous voltage points or damage parts. Never spill liquid of any kind on the TV.
- Ground outdoor antennas. If an outside antenna or cable system is connected to the TV, be sure the antenna or cable system is grounded so as to provide some protection against voltage surges and built-up static charges. Section 810 of the National Electrical Code, ANSI/NFPA No.70-1984, provides information about proper grounding of the mast and supporting structure, grounding of the lead-in wire to an antenna discharge unit, size of grounding conductors, location of antenna discharge unit, connection to grounding electrodes, and requirements for the grounding electrode.

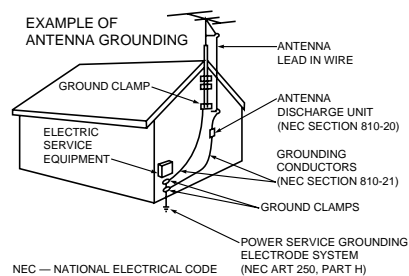

- Do not attempt to service the TV yourself. Refer all servicing to qualified service personnel. Unplug the unit from the wall outlet and refer servicing to qualified service personnel under the following conditions:
 - when the power-supply cord or plug is damaged
 - if liquid has been spilled on the unit or if objects have fallen into the unit
 - if the TV has been exposed to rain or water
 - if the TV does not operate normally by following the operating instructions
 - if the TV has been dropped or the cabinet has been damaged
 - when the TV exhibits a distinct change in performance
- If you make adjustments yourself, adjust only those controls that are covered by the operating instructions. Adjusting other controls may result in damage and will often require extensive work by a qualified technician to restore the TV to normal.
- When replacement parts are required, be sure the service technician uses replacement parts specified by the manufacturer or those that have the same characteristics as the original part. Unauthorized substitutions may result in additional damage to the unit.
- Upon completion of any service or repairs to this TV, ask the service technician to perform safety checks to determine that the TV is in a safe operating condition.

This device complies with part 15 of the FCC Rules. Operation is subject to the following two conditions:

- (1) This device may not cause harmful interference, and**
- (2) This device must accept any interference that may cause undesired operation.**

This television receiver provides display of television closed captioning in accordance with §15.119 of the FCC rules.

Important Warranty Information Regarding Television Format Viewing

Standard screen format televisions (4:3, the aspect ratio of the screen width to height) are primarily designed to view standard format full-motion video. The images displayed on them should primarily be in the standard 4:3 ratio format and constantly moving. Displaying stationary graphics and images on screen, such as the dark top and bottom letterbox bars (wide screen pictures), should be limited to no more than 15% of the total television viewing per week.

Wide screen format televisions (16:9, the aspect ratio of the screen width to height) are primarily designed to view wide screen format full-motion video. The images displayed on them should primarily be in the wide screen 16:9 ratio format, or expanded to fill the screen if your model offers this feature, and constantly moving. Displaying stationary graphics and images on screen, such as the dark side-bars on non-expanded standard format television video and programming, should be limited to no more than 15% of the total television viewing per week.

Additionally, viewing other stationary images and text such as stock market reports, video game displays, station logos, web sites or computer graphics and patterns, should be limited as described above for all televisions. *Displaying any stationary images that exceed the above guidelines can cause uneven aging of picture tubes (CRTs) that leave subtle, but permanent burned-in ghost images in the television picture. To avoid this, vary the programming and images, and primarily display full screen moving images, not stationary patterns or dark bars.* On television models that offer picture sizing features, use these controls to view the different formats as a full screen picture.

Be careful in the selection and duration of television formats used for viewing. Uneven CRT aging as a result of format selection and use, as well as other burned-in images, is not covered by your Samsung limited warranty.

Chapter 1: Your New TV 1.1

List of Features	1.1
Familiarizing Yourself with Your New TV	1.2
Front Panel Buttons	1.2
Side Panel Jacks	1.3
Rear Panel Jacks (Depending on the model)	1.4
Remote Control	1.5

Chapter 2: Installation 2.1

Connecting VHF and UHF Antennas	2.1
Antennas with 300-ohm Flat Twin Leads	2.1
Antennas with 75-ohm Round Leads	2.2
Separate VHF and UHF Antennas	2.2
Connecting Cable TV	2.2
Cable without a Cable Box	2.2
Connecting to a Cable Box that Descrambles All Channels	2.3
Connecting to a Cable Box that Descrambles some Channels	2.3
Connecting a VCR	2.5
Connecting a Second VCR to Record from the TV	2.6
Connecting a Camcorder	2.6
Connecting a DVD Player, DTV Set-Top Box (480i, 480p, 1080i)	2.7
Connecting to Y, P _B , P _R	2.7
Connecting to regular audio and video jacks	2.7
Connecting a DTV Set-Top Box (480p, 1080i)	2.8
Installing Batteries in the Remote Control	2.9

Chapter 3: Operation 3.1

Turning the TV On and Off	3.1
Plug & Play Feature	3.1
Using the Perfect Focus Feature	3.3
Adjusting Manual convergence	3.4
Adjust Red Convergence	3.5
Viewing the Menus and On-Screen Displays	3.6
Viewing the Menu	3.6
Viewing the Display	3.6
Selecting a Menu Language	3.7
Selecting the Antenna Input	3.7
Memorizing the Channels	3.8
Selecting the Video Signal-source	3.8
Storing Channels in Memory (Automatic Method)	3.9
Adding and Erasing Channels (Manual Method)	3.9
Changing Channels	3.10
Using the Channel Buttons	3.10
Using the Number Buttons	3.10
Using the Previous Channel	3.10
Selecting Your Favorite Channels	3.11
To Store Your Favorite Channels:	3.11
To View Your Favorite Channels:	3.11
Adding and Erasing Channels (Manual Method)	3.12
Labeling the Channels	3.13
Picture Control	3.14
Customizing the Picture	3.14
Using Automatic Picture Settings	3.15
Selecting the Color Tone	3.16

CONTENTS

Chapter 3: Operation (Cont.)	3.16
Sound Control	3.16
Adjusting the Volume	3.16
Using Mute	3.16
Customizing the Sound	3.17
Using Automatic Sound Settings	3.18
Setting the Clock	3.19
Viewing an External Signal Source	3.20
Chapter 4: Special Features	4.1
Fine Tuning Channels	4.1
Digital Noise Reduction	4.2
Changing the Screen Size	4.3
Using the R.surf Feature	4.4
Setting the On/Off Timer	4.5
Setting the Sleep Timer	4.6
Extra sound settings	4.7
Choosing a Multi-Channel Sound (MTS) track	4.8
Viewing Closed Captions	4.9
Viewing Picture-in-Picture	4.10
Activating Picture-in-Picture	4.10
Selecting a Signal Source (Antenna or Cable) for PIP	4.11
Selecting a Signal Source (External A/V) for PIP	4.11
Swapping the Contents of the PIP image and Main image	4.12
Changing the Size of the PIP Window	4.12
Changing the PIP Channel	4.13
Changing the Location (Rotating) the PIP mode	4.13
Scanning the Available Channels	4.13
Viewing the Demonstration	4.14
Customizing Your Remote Control	4.15
Setting Up Your Remote Control to Operate Your VCR or DVD	4.15
Setting Up Your Remote Control to Operate Your Cable Box	4.16
Chapter 5: Troubleshooting	5.1
Identifying Problems	5.1
Appendix	A.1
Cleaning and Maintaining Your TV	A.1
Using Your TV in Another Country	A.1
Specifications	A.1

Chapter One

YOUR NEW TV

List of Features

Your Samsung TV was designed with the latest technology. This TV is a high-performance unit that includes the following special features:

- Easy-to-use remote control
- Easy-to-use on-screen menu system
- Automatic timer to turn the TV on and off
- Adjustable picture and sound settings that can be stored in the TV's memory
- Automatic channel tuning for up to 181 channels
- A special filter to reduce or eliminate reception problems
- Fine tuning control for the sharpest picture possible
- A built-in multi-channel sound decoder for stereo and bilingual listening
- Built-in, dual channel speakers
- A special sleep timer
- Picture-in-Picture
- Component Video Input jacks to obtain a sharper image from external sources
- Perfect Focus

Familiarizing Yourself with The TV

Front Panel Buttons

The buttons on the front panel control your TV's basic features, including the on-screen menu. To use the more advanced features, you must use the remote control.

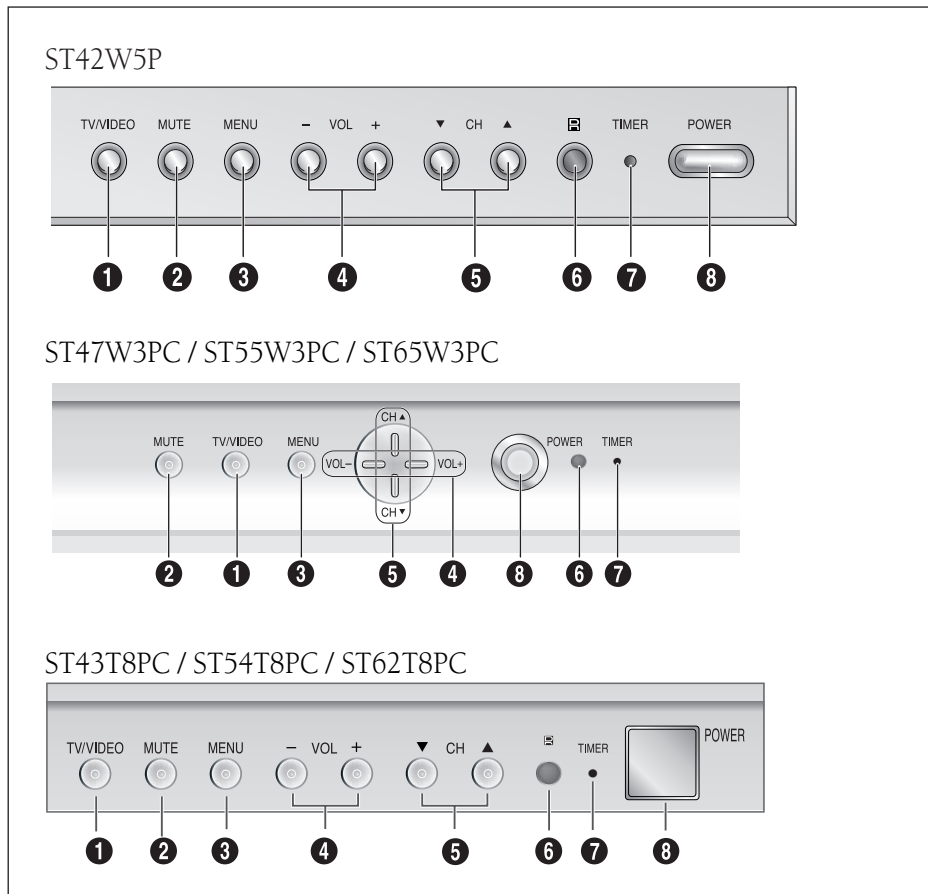

1 TV/VIDEO

All the inputs connected to the external component jacks will be shown in regular sequence.

2 MUTE

Press to temporarily cut off the sound.

3 MENU

Press to see an on-screen menu of your TV's features.

4 VOL - , +

Press to increase or decrease the volume. Also used to select items on the on-screen menu.

5 CH▼ and CH▲

Press to change channels. Also press to highlight various items on the on-screen menu.

6 Remote Control Sensor

Aim the remote control towards this spot on the TV.

7 Timer indicator

When the TV is turned on, the Timer indicator blinks about ten times. This indicator illuminates when the Timer mode is set to the "On" position after setting the clock and either the On timer or Off timer, with the remote control. Even if the power is turned off, this indicator stays lit. (Clock must be set before using this function.).

8 POWER

Press to turn the TV on and off.

YOUR NEW TV

Side Panel Jacks

You can use the side panel jacks to connect an A/V component that is used only occasionally, such as a camcorder or video game. (For information on connecting equipment, see pages 2.1 – 2.8.)

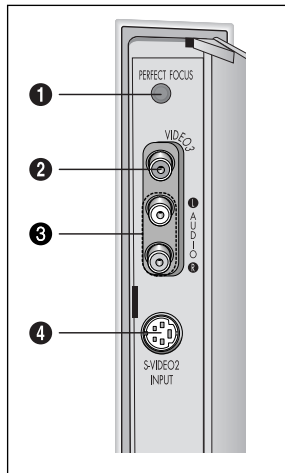

1 PERFECT FOCUS

Press to adjust for the optimum picture set in the Factory.

2 VIDEO INPUT jack

Use to connect a video signal from a camcorder or a video game.

3 AUDIO INPUT jacks

Use to connect the audio signals from a camcorder or video game.

4 S-VIDEO INPUT jack

Use to connect an S-Video signal from a camcorder or a video game.

Using the Component Shelf

You can place a VCR, a DVD player, etc. on the Component Shelf.

ST47W3PC / ST55W3PC / ST65W3PC

<p>1 Press the symbol "⏏" in the center of the Component Shelf door.</p>	<p>2 As shown in figure below, hold the center of door and lift it up.</p>	<p>3 After placing a component on the shelf, hold the center of door and pull it down as shown in figure below.</p>	<p>4 Shut the door by pressing the "⏏" symbol.</p>
			<p>Note: When placing a component on the shelf, make sure it is no more than 5 inches tall and leave one inch of space from the front and sides for ventilation.</p>

ST54T8PC / ST62T8PC

<p>1 Hold the center of the door and lift it up in the direction of arrow.</p>	<p>2 After placing a component you have in the display deck, hold the center of the door and pull it down.</p>	<p>Note: You should display only the component that is within 126mm high. When displaying a component in the display deck, please space it out 30mm from the front, 20mm from either end.</p>

YOUR NEW TV

Rear Panel Jacks (Depending on the model)

Use the rear panel jacks to connect an A/V component that will be connected continuously, such as a VCR or a DVD player.

Because there are two sets of input jacks, you can connect two different A/V components (i.e., a VCR and a DVD, 2 VCRs, etc.)

For more information on connecting equipment, see pages 2.1 – 2.8.

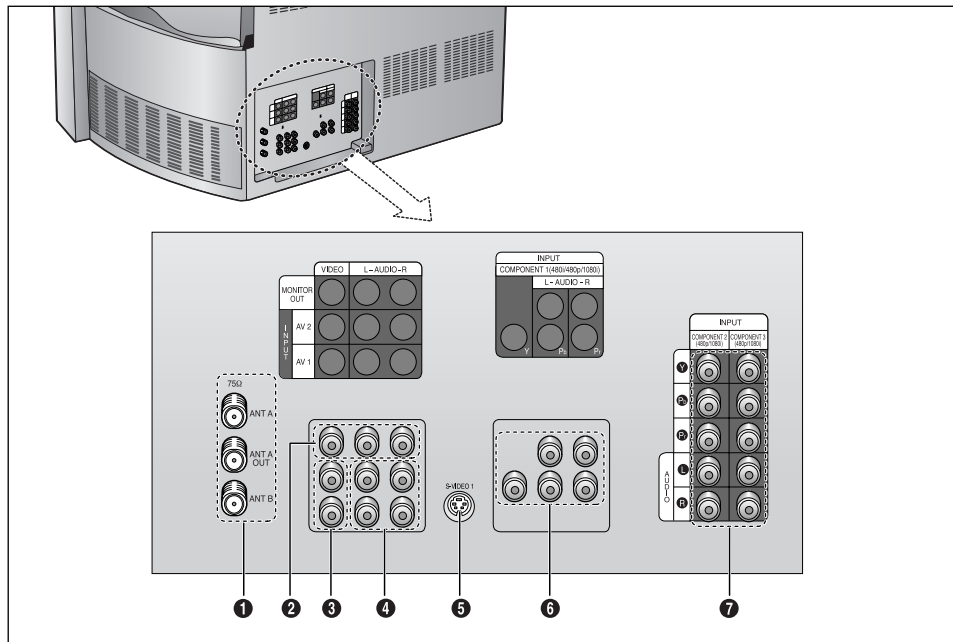

1 ANTENNA terminals

Two independent cables or antennas can be connected to these terminals. Use ANT-A and ANT-B terminals to receive a signal from VHF/UHF antennas or your cable system. Use the ANT-A OUT terminal to send the signal being received by the ANT-A terminal out to another component (such as a Cable Set Top Box). The PIP channel can be received only when a signal source is connected to ANT-A.

2 AUDIO-VIDEO MONITOR OUTPUT jacks

Connect to the audio/video input jacks of a recording VCR.
Note: The monitor out does not operate in DVD or DTV mode.

3 VIDEO INPUT jacks

Connect to the video output jacks of VCRs, DVD players and similar devices (Two sets are available: Video1 and Video2).

4 AUDIO INPUT jacks

Connect to the audio output jacks of VCRs, DVD players and similar devices.

5 S-VIDEO INPUT jack

Connect to an S-VHS VCR or DVD player.

6 COMPONENT 1 (480i, 480p, 1080i) AUDIO/VIDEO INPUT jacks

Connect a source that outputs 480i/480p/1080i Y, P_B and P_R signals, such as a DVD (or DTV Set-Top Box).

7 COMPONENT 2, 3 (480p, 1080i) AUDIO/VIDEO INPUT jacks

Connect a source that outputs 480p/1080i Y, P_B and P_R signals, such as a DTV Set-Top Box. (The Component3 jack is available on ST47W3PC / ST55W3PC / ST65W3PC)

YOUR NEW TV

Remote Control

You can use the remote control up to about 23 feet from the TV. When using the remote, always point it directly at the TV.

You can also use your remote control to operate your VCR and cable box. See page 4.20 for details.

1 Power

Turns the TV on and off.

2 +100

Press to select channels over 100. For example, to select channel 121, press "+100," then press "2" and "1."

3 Still(Main)

Press to stop the action during a particular scene. Press again to resume normal video.

4 CH \downarrow and CH \uparrow (Channel Up/Down)

Press CH \downarrow or CH \uparrow to change channels.

VOL -, VOL +

Press increase or decrease the volume.

5 Sleep

Press to select a preset time interval for automatic shutdown.

6 Display

Press to display the current channel and the audio-video settings.

7 Aspect

Press to change the screen size.

8 BBE

BBE is a built-in effect that adds clarity, punch and dynamics to the sound.

9 MTS (Multichannel Television Sound)

Press to choose stereo, mono or Separate Audio Program (SAP broadcast).

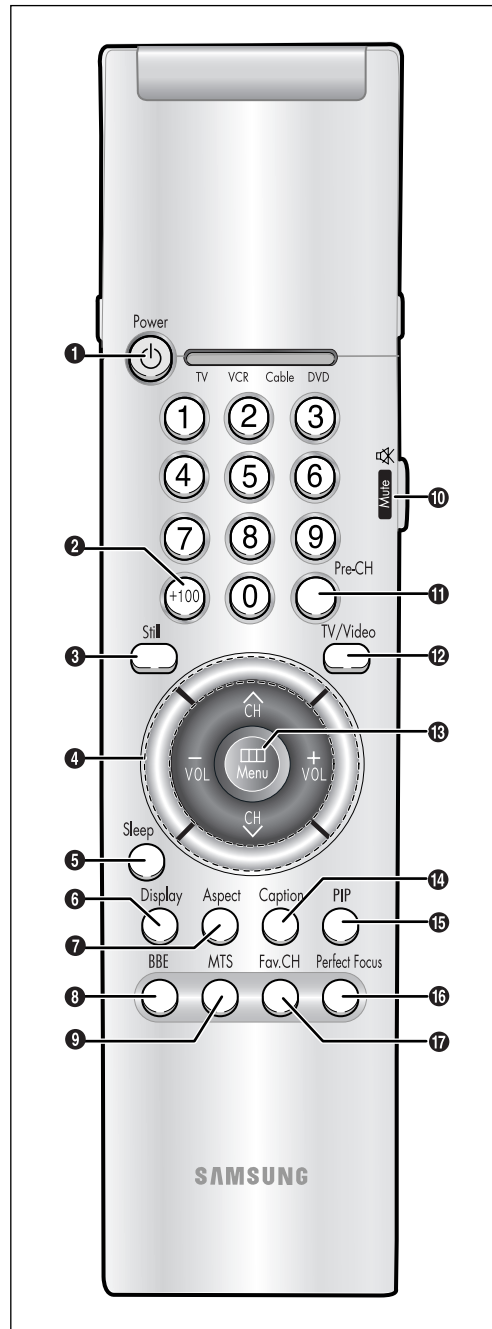

10 Mute

Press to temporarily cut off the sound.

11 Pre-CH

Tunes to the previous channel.

12 TV/Video

All the inputs connected to the external component jacks will be shown in regular sequence.

13 Menu

Displays the main on-screen menu.

14 Caption

Controls the caption decoder.

15 PIP

Activates picture in picture.

16 Perfect Focus

Press to adjust for the optimum picture set in the Factory.

17 Fav. CH (Favorite Channel)

Press to switch between your favorite channels.

YOUR NEW TV

Remote Control (continued)

18 ANT A/B

Press to select the ANT A or ANT B.

19 R.surf

Press to automatically return to a preferred channel after a user-preset time delay.

20 S.Mode

Adjust the TV sound by selecting one of the preset factory settings (or select your personal, customized sound settings).

21 P.Mode

Adjust the TV picture by selecting one of the preset factory settings (or select your personal, customized picture settings).

22 VCR controls

Controls VCR tape functions: Rewind, Play, Fast Forward, Stop, Pause.

23 PIP Controls

Source

Press to select one of the available signal sources for the PIP window.

Scan

Press to memorize (scan) the available channels.

Locate

Press to move the PIP window to any of the four corners of the TV screen.

Swap

Exchanges the video signal that is currently displayed on the main screen with the signal in the PIP window.

Size

Press to make the PIP window large, small or stock ticker.

CH

Displays the available channels in sequence. (These buttons change channels in the PIP window only).



24 Mode

Selects a target device to be controlled by the Samsung remote control (i.e., TV, VCR, Cable box or DVD).

25 Set

Used during set up of this Samsung remote control, so that it will work compatibly with other devices (VCR, cable box, DVD.)

26 V.Chip

Press to set up and activate the parental locks. (Not available)

27 Add/Erase

Press to add or erase channels in the TV's memory.

Chapter Two

INSTALLATION

Connecting VHF and UHF Antennas

If your antenna has a set of leads that look like this, see “Antennas with 300-ohm Flat Twin Leads,” below.

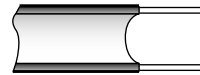

If your antenna has one lead that looks like this, see “Antennas with 75-ohm Round Leads,” on page 2.2.

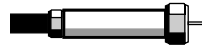

If you have two antennas, see “Separate VHF and UHF Antennas,” on page 2.2.

Antennas with 300-ohm Flat Twin Leads

If you are using an off-air antenna (such as a roof antenna or “rabbit ears”) that has 300-ohm twin flat leads, follow the directions below.

1

Place the wires from the twin leads under the screws on the 300-75 ohm adaptor (not supplied). Use a screwdriver to tighten the screws.

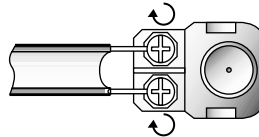

2

Plug the adaptor into the ANT-A or ANT-B terminal on the rear panel.

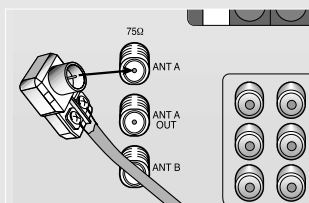

INSTALLATION

Antennas with 75-ohm Round Leads

Plug the antenna lead into the ANT-A or ANT-B terminal on the rear panel.

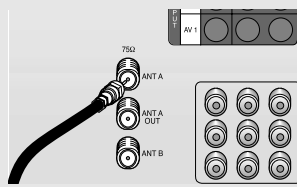

Separate VHF and UHF Antennas

If you have two separate antennas for your TV (one VHF and one UHF), you must combine the two antenna signals before connecting the antennas to the TV. This procedure requires an optional combiner-adaptor (available at most electronics shops).

1

Connect both antenna leads to the combiner.

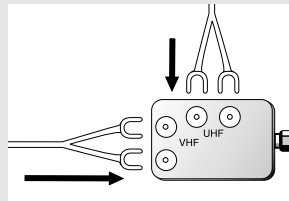

2

Plug the combiner into the ANT-A or ANT-B terminal on the rear panel.

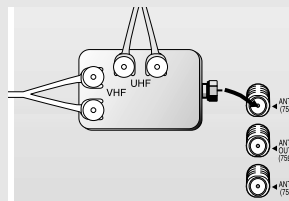

Connecting Cable TV

You can connect different cable systems to your TV, including cable without a cable box, and cable with a cable box that descrambles some or all channels.

Cable without a Cable Box

If you want to connect cable, and you do not need to use a cable box:

Plug the incoming cable into the ANT-A or ANT-B antenna terminal on the rear of the TV.

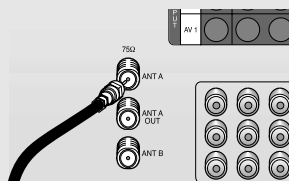

INSTALLATION

Cable with a Cable box that Descrambles All Channels

1

Find the cable that is connected to the ANTENNA OUT terminal on your cable box. This terminal might be labeled "ANT OUT", "VHF OUT", or simply, "OUT".

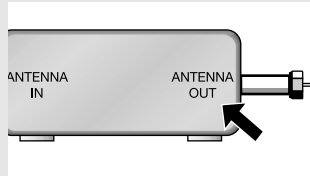

2

Connect the other end of this cable to the ANT-A or ANT-B terminal on the rear of the TV.

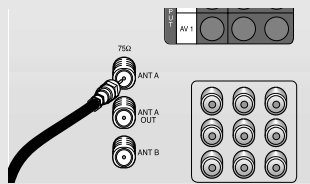

Connecting to a Cable Box that Descrambles Some Channels

If your cable box descrambles only some channels (such as premium channels), follow the instructions below. You will need a two-way splitter, an RF (A/B) switch, and four lengths of coaxial cable. (These items are available at most electronics stores.)

1

Find and disconnect the cable that is connected to the ANTENNA IN terminal on your cable box.

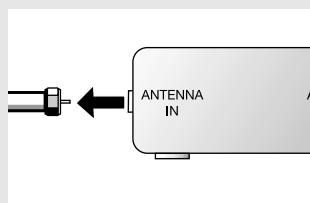

◀ This terminal might be labeled "ANT IN," "VHF IN," or simply, "IN."

2

Connect this cable to a two-way splitter.

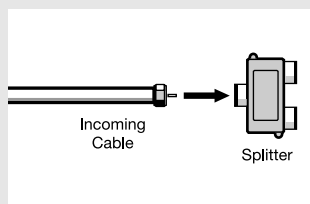

3

Connect a coaxial cable between an OUTPUT terminal on the splitter and the IN terminal on the cable box.

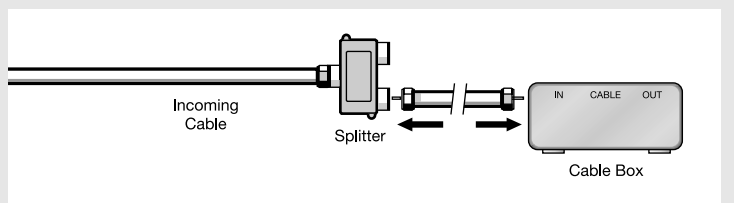

INSTALLATION

4

Connect a coaxial cable between the ANTENNA OUT terminal on the cable box and the B-IN terminal on the A/B switch.

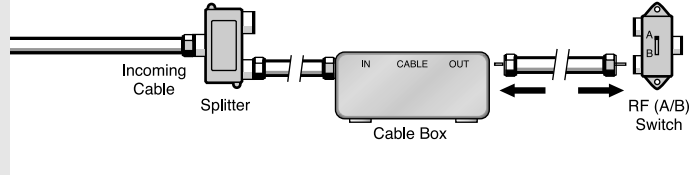

5

Connect another cable between the other OUT terminal on the splitter and the A-IN terminal on the RF (A/B) switch.

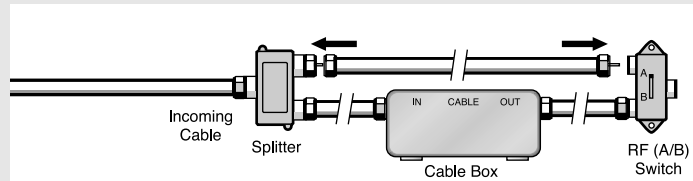

6

Connect the last coaxial cable between the OUT terminal on the RF (A/B) switch and the VHF/UHF terminal on the rear of the TV.

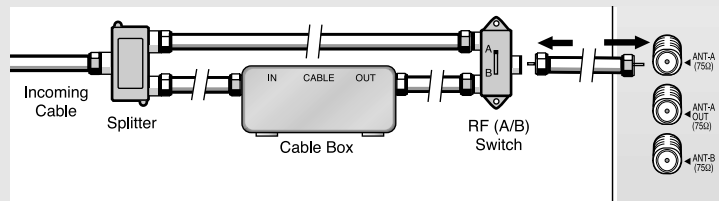

After you've made this connection, set the A/B switch to the "A" position for normal viewing. Set the A/B switch to the "B" position to view scrambled channels. (When you set the A/B switch to "B," you will need to tune your TV to the cable box's output channel, which is usually channel 3 or 4.)

INSTALLATION

Connecting a VCR

These instructions assume that you have already connected your TV to an antenna or a cable TV system (according to the instructions on pages 2.1-2.3). Skip step **1** if you have not yet connected to an antenna or a cable system.

1

Connect a coaxial cable between the ANTENNA OUT terminal on the VCR and the antenna terminal on the TV.

A coaxial cable is usually included with a VCR. (If not, check your local electronics store).

2

Connect a set of audio cables between the AUDIO OUT jacks on the VCR and the AUDIO jacks on the TV.

If you have a mono VCR, connect L (mono) to VCR audio out using only one audio cable.

3

Connect a video cable between the VIDEO OUT jack on the VCR and the VIDEO jack on the TV.

If you have a S-VHS VCR, use the S-Video connections and remove the video cable. Do not connect the video cable and the S-Video cable to video 1 simultaneously.

Follow the instructions in "Viewing a VCR or Camcorder Tape" to view your VCR tape.

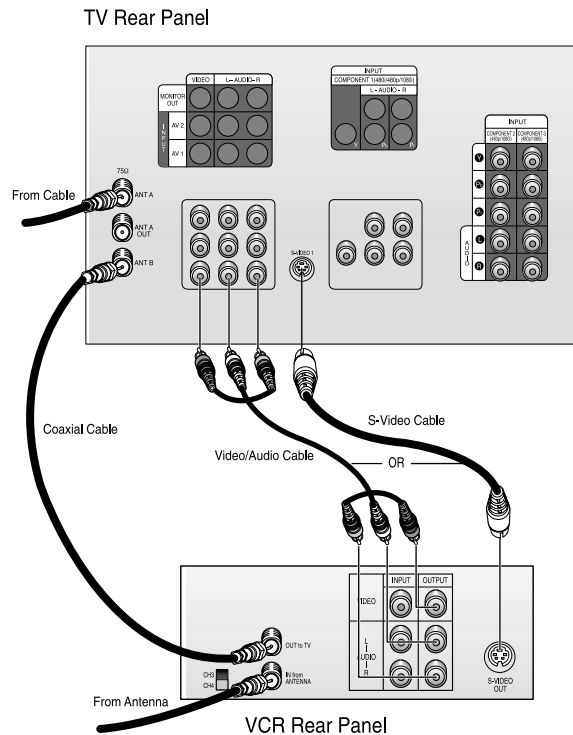

Note: This figure shows the Standard Connector-jack panel. The actual configuration on your TV may be different, depending on the model.

INSTALLATION

Connecting a Second VCR to Record from the TV

Your TV can send out signals of its picture and sound to be recorded by a second VCR. To do this, connect your second VCR as follows:

1

Connect a set of audio cables between the AUDIO OUT jacks on the TV and the AUDIO IN jacks on the VCR.

(The VCR input jacks might be either on the front or rear of the VCR.)

2

Connect a video cable between the VIDEO OUT jack on the TV and the VIDEO IN jack on the VCR.

Refer to your VCR's instructions for more information about how to record using this kind of connection.

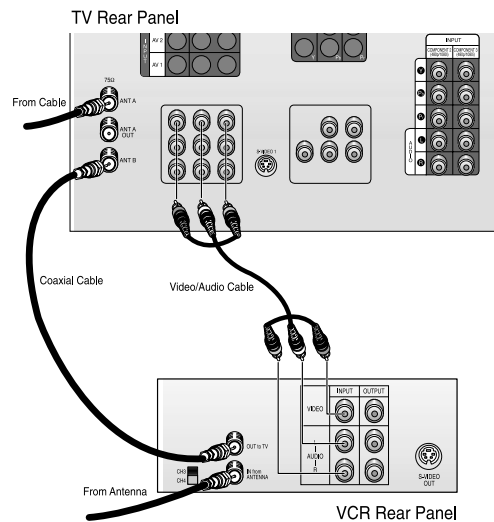

Connecting a Camcorder

The side panel jacks on your TV make it easy to connect a camcorder to your TV. They allow you to view the camcorder tapes without using a VCR.

1

Locate the A/V output jacks on the camcorder. They are usually found on the side or rear of the camcorder.

2

Connect an audio cable between the AUDIO OUTPUT jack on the camcorder and the AUDIO terminals on the side of the TV.

If you have mono camcorder, connect L(mono) to camcorder audio out using only one audio cable.

3

Connect a video cable between the VIDEO OUTPUT jack on the camcorder and the VIDEO terminal on the side of the TV.

The audio-video cables shown here are usually included with a Camcorder. (If not, check your local electronics store.) If your camcorder is stereo, you need to connect a set of two cables.

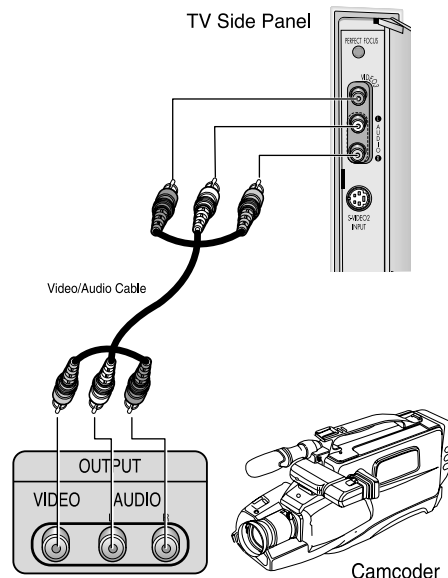

Note: This figure shows the Standard Connector-jack panel. The actual configuration on your TV may be different, depending on the model.

INSTALLATION

Connecting a DVD Player, DTV Set-Top Box (480i, 480p, 1080i)

The rear panel jacks on your TV make it easy to connect a DVD player (or DTV Set-Top Box) to your TV.

Connecting to Y, P_B, P_R

1

Connect a set of audio cables between the DVD audio in jacks on the TV and the AUDIO OUT jacks on the DVD player (or DTV Set-Top Box).

2

To enable Component video viewing, connect video cables between the Y, P_B, and P_R inputs on the TV and Y, P_B, and P_R (or Y, C_B, C_R) outputs on the DVD player (or DTV Set-Top Box).

Note: For an explanation of Component video, see your DVD player's (or DTV Set-Top Box) owner's instruction.

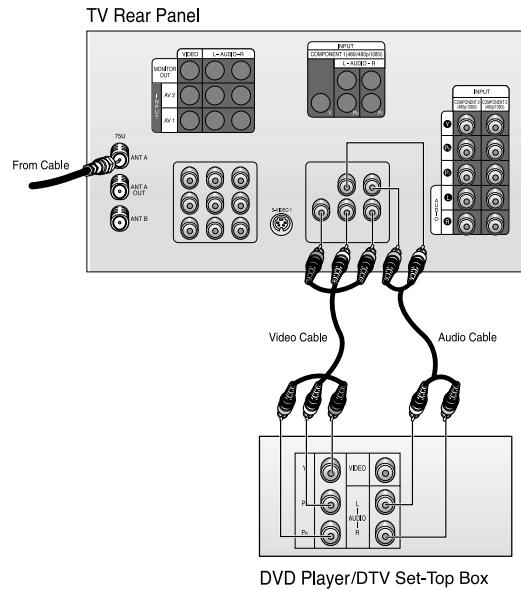

Connecting to regular audio and video jacks

1

Connect a set of audio cables between the AUDIO IN jacks on the TV and the AUDIO OUT jacks on the DVD player (or DTV Set-Top Box).

2

Connect video cables between the VIDEO OUT jack on the DVD player (or DTV Set-Top Box) and the VIDEO IN jack on the TV.

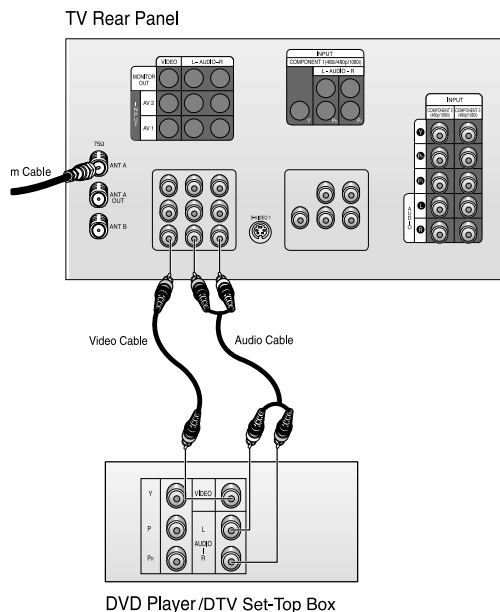

Note: This figure shows the Standard Connector-jack panel. The actual configuration on your TV may be different, depending on the model.

INSTALLATION

Connecting a DTV Set-Top Box (480p, 1080i)

When switching to the DTV mode, either 480p or 1080i format is automatically selected according to the input signal.

Note: Only 480p and 1080i formats are supported.

1

Connect a set of audio cables between the DTV Set-Top Box audio in jacks on the TV and the AUDIO OUT jacks on the DTV Set-Top box.

2

To enable Component video viewing, connect video cables between the Y, P_B, and P_R inputs on the TV and Y, P_B, and P_R (or Y, C_B, C_R) outputs on the DTV Set-Top box.

Note: For an explanation of Component video, see your DTV Set-top box's owner's instruction.

TV Real Panel

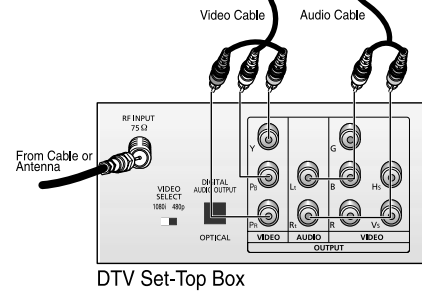
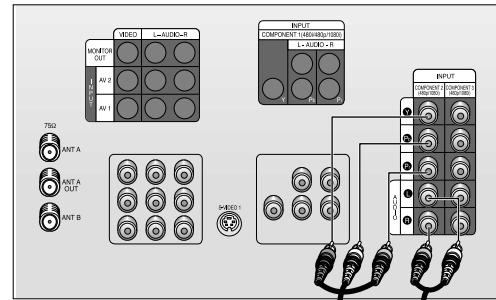

DTV Set-Top Box

INSTALLATION

Installing Batteries in the Remote Control

1

Slide the back cover all the way out to open the battery compartment of the remote control.

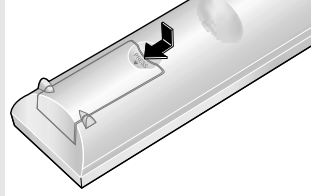

2

Install two AAA size batteries.

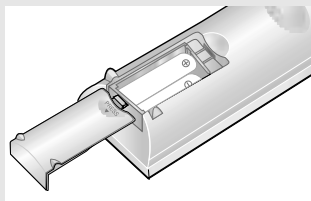

◀ Make sure to match the “+” and “-” ends of the batteries with the diagram inside the compartment.

3

Replace the cover.

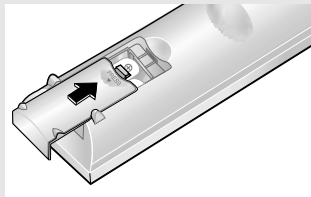

◀ Remove the batteries and store them in a cool, dry place if you won't be using the remote control for a long time.

The remote control can be used up to about 23 feet from the TV.

(Assuming typical TV usage, the Batteries last for about one year.)

Chapter Three

OPERATION

Turning the TV On and Off

Press the **Power** button.
You can also use the **POWER** button on the front panel.

Plug & Play Feature

When the TV is initially powered On, five basic customer settings proceed automatically and subsequently: Setting the language, Ant. input check, and Auto program/Setting the Clock.

1

Press the **Power** button on the remote control.

The message "Plug & Play" is displayed.
It flickers for a little while and then the "Language" menu is automatically displayed.



2

Press the **VOL +** or **VOL -** button to select the desired language. Press the **Menu** button to enter the language, and then the "ANT/CATV" menu is automatically displayed.

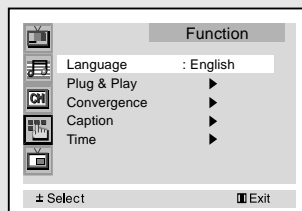

3

Press the **VOL +** or **VOL -** button to select the desired video signal source. Press the **Menu** button to enter the video signal source, and then the "Ant Input check" is automatically displayed.

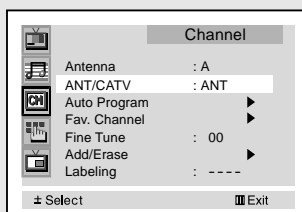

continued...

OPERATION

4

Make sure that the antenna is connected to the TV. And then press the **VOL +** or **VOL -** button to activate "Auto Program" or press the MENU button to skip. (refer to "Auto program" on page 3.9)

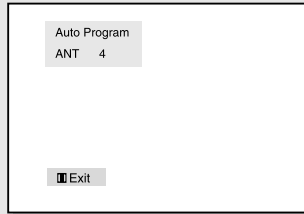

5

Press the **VOL +** or **VOL -** button to move to the hour or minute. Set the hour or minute by pressing the **CH ^** or **CH v** button. (refer to "Setting the clock" on page 3.19)

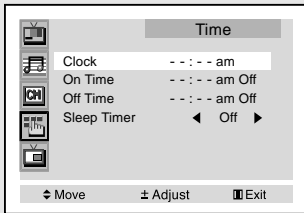

6

When you have finished, press the **Menu** button. The message "Enjoy your watching.." is displayed.



7

If you want to reset this feature

- (1) Press the **Menu** button.
- (2) Press the **CH v** button three times to select the Function menu and press the **VOL +** button.
- (3) Press the **CH v** button to select "Plug & Play" and press the **VOL +** button. The message "Plug & Play" is displayed.

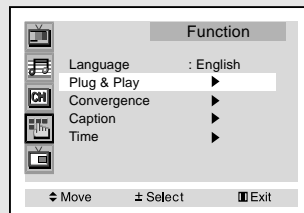

Note: Plug & Play feature doesn't work when in the A/V mode.

Using the Perfect Focus Feature

When the picture size is distorted after moving the TV set, use the Perfect Focus feature to adjust for the optimum picture size set in the Factory.

1

Press the **Menu** button.

Press the **CH** ∇ button to select "Function", then press the **VOL +** button.

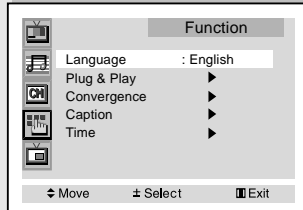

◀ You can also select Perfect Focus by pressing the Perfect Focus button.

2

Press the **CH** ∇ button to select "Convergence", then press the **VOL +** button.

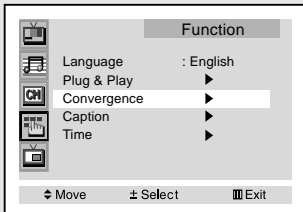

3

Press the **CH** ∇ button to select "Perfect Focus", then press the **VOL +** button.

Perform Perfect Focus in the following sequence: Green → Red → Blue.

Press **Menu** button to exit.

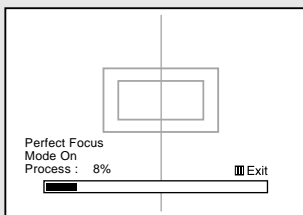
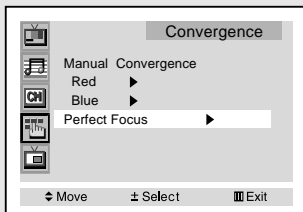

Notes

- If any error happens during Perfect Focus, then perform Perfect Focus once again.
- If you can't make adjustments after Perfect Focus, then make manual adjustments. Still you can't make adjustments, contact your Service Center.
- The Perfect Focus function doesn't operate when component input is in 480P.

OPERATION

Adjusting Manual Convergence

If the color appears spread out or “smeared” on the screen, the convergence probably needs alignment. Be sure to use the remote control for the convergence adjustments.

First steps:

1

Press the **Menu** button.

Press the **CH** ∇ button to select “Function”, then press the **VOL +** button.

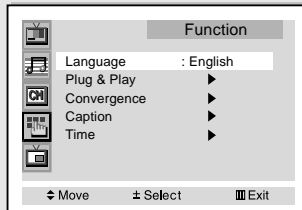

2

Press the **CH** ∇ button to select “Convergence”, then press the **VOL +** button.

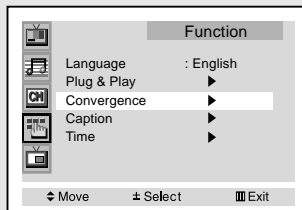

3

The “Manual Convergence” screen will appear, and the word “Red” will be highlighted.

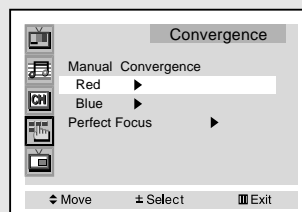

continued...

OPERATION

Adjust Red Convergence

4

While "Red" is highlighted, press the **VOL +** button: A crosshair pattern will appear on the screen. After moving the cursor to the position you want to adjust using the number buttons 2(up), 4(left), 6(right), 8(down) on the remote control, adjust Red Convergence by pressing the **VOL +/VOL -/CH ^/CH v** buttons.

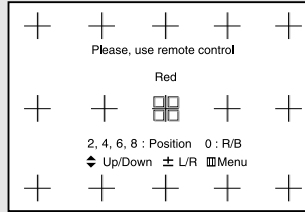

5

If a horizontal red line is visible, use **CH ^** and **CH v** buttons to move the line so that it is superimposed on the horizontal center-line (i.e., make a single horizontal line that is as white as possible.)

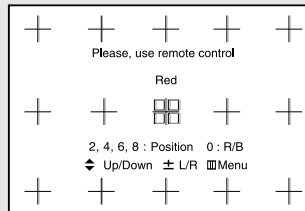

6

If a vertical red line is visible, use the **VOL +** and **VOL -** buttons to move the line so that it is superimposed on the vertical-center line (i.e., make a single vertical line that is as white as possible.)

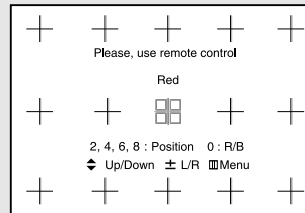

7

For 'Blue' adjustment, do the same as the above.

After the red convergence is correctly adjusted, press **Menu** to exit all the menus.

Viewing the Menus and On-Screen Displays

Viewing the Menus

1

With the power on, press the **Menu** button.

The "Picture" menu appears on the screen. Its left side has five icons: Picture, Sound, Channel, Function and PIP.

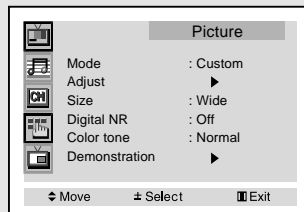

◀ The on-screen menus disappear from the screen after thirty seconds.

2

Press the **CH** \wedge or **CH** \vee button to move items in the menu (the icons blink when highlighted). Press the **VOL +** or **VOL -** button to display, change, or use the selected items. Press the **VOL +** button to enter items in the menu.

◀ You can also use the **Menu**, **CHANNEL**, and **VOLUME** buttons on the control panel of the TV to make selections.

3

Press the **Menu** button to exit.

Viewing the Display

The display identifies the current channel and the status of certain audio-video settings.

1

Press the **Display** button on the remote control.

The TV will display the channel, the type of audio, and the status of certain video and audio settings.

(" * " indicates a channel has been manually fine tuned.)

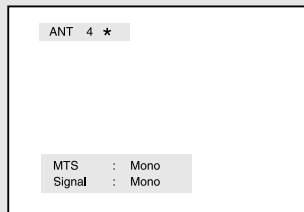

◀ The on-screen displays disappear after ten seconds.

OPERATION

Selecting a Menu Language

1

Press the **Menu** button.

Press the **CH** ∇ button to select "Function", then press the **VOL +** button.

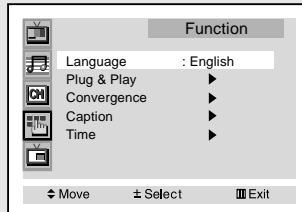

2

Press the **CH** ∇ button to select "Language", then press the **VOL +** or **VOL -** button to select the language.

Press the **Menu** button to exit.

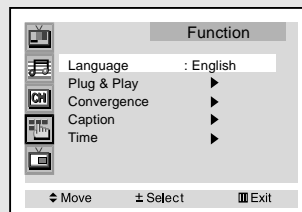

Selecting the Antenna Input

You can connect to two different signal sources by choosing the antenna input (Antenna A or Antenna B).

1

Press the **Menu** button .

Press the **CH** ∇ button to select "Channel", then press the **VOL +** button to enter.

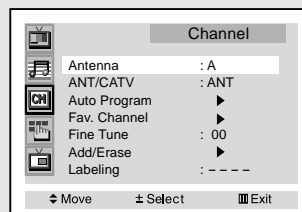

2

Press the **VOL +** or **VOL -** button to select "A" or "B".

Press the **Menu** button to exit.

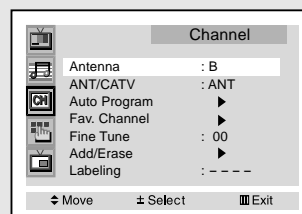

Memorizing the Channels

Your TV can memorize and store all of the available channels for both “off-air” (antenna) and cable channels. After the available channels are memorized, use the CH \wedge and CH \vee buttons to scan through the channels. This eliminates the need to change channels by entering the channel digits. There are three steps for memorizing channels: selecting a broadcast source, memorizing the channels (automatic) and adding and deleting channels (manual).

Selecting the Video Signal-source

Before your television can begin memorizing the available channels, you must specify the type of signal source that is connected to the TV (i.e., an antenna or a cable system).

1

Press the **Menu** button.

Press the **CH \vee** button to select “Channel”, then press the **VOL +** button.

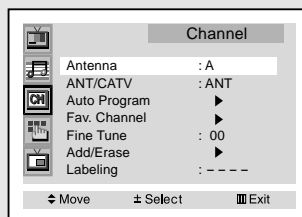

2

Press the **CH \vee** button to select “ANT/CATV”, then Press the **VOL +** or **VOL -** button to cycle through these choices: ANT (antenna), STD, HRC or IRC.

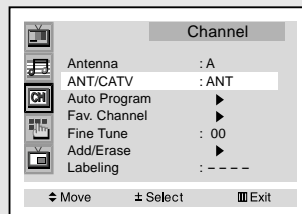

Note: STD, HRC and IRC identify various types of cable TV systems. Contact your local cable company to identify the type of cable system that exists in your particular area.

At this point the signal source has been selected. Proceed to “Storing Channels in Memory” (next page).

OPERATION

Storing Channels in Memory (Automatic Method)

1

First, select the correct signal source (ANT, STD, HRC, IRC). See steps 1-2 on previous page.

Press the **Menu** button.
Press the **CH** ∇ button to select "Channel", then press the **VOL +** button

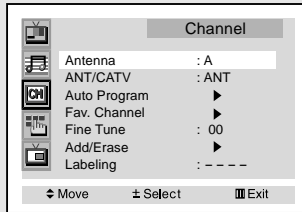

2

Press the **CH** ∇ button to select "Auto Program", then press the **VOL +** button.

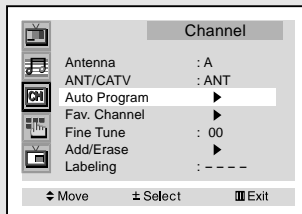

3

The TV will begin memorizing all of the available channels.

After all the available channels are stored, the Auto program menu reappears. Press the Menu button to exit.

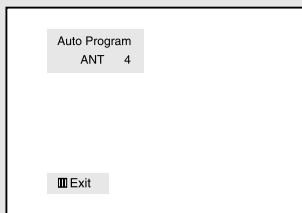

◀ The TV automatically cycles through all of the available channels and stores them in memory. This takes about one to two minutes.

Adding and Erasing Channels (Manual Method)

1

Use the number buttons to directly select the channel that will be added or erased.

2

Press the **Add/Erase** button:
Repeatedly pressing this button will alternate between "Added" and "Erased."

Press the **Menu** button to exit.

You can view any channel (including an erased channel) by using the number buttons on the remote control.

Changing Channels

Using the Channel Buttons

Press the **CH[^]** or **CH^v** button to change channels.

When you press **CH[^]** or **CH^v**, the TV changes channels in sequence. You will see all the channels that the TV has memorized. (The TV must have memorized at least three channels.) You will not see channels that were either erased or not memorized.

Using the Number Buttons

Use the number buttons to quickly tune to any channel.

Press the number buttons to go directly to a channel. For example, to select channel 27, press "2," then "7". The TV will change channels when you press the second number.

When you use the number buttons, you can directly select channels that were either erased or not memorized.

To select a channel over 100, press the +100 button. (For channel 122, press "+100," then "2," then "2.")

To change to single-digit channels (0–9) faster, press "0" before the single digit. (For channel "4," press "0," then "4.")

Using the Previous Channel

Press the **Pre-CH** button. The TV changes to the last channel you were watching.

Selecting Your Favorite Channels

You can store up to ten of your favorite channels for each available input source (such as TV and CATV). Then, when you press the Fav.CH button on the remote control, the TV displays only the favorite channels you previously stored, allowing you to quickly and easily find frequently watched channels.

To Store Your Favorite Channels:

1

Press the **Menu** button.

Press the **CH** ∇ button to select "Channel", then press the **VOL +** button.

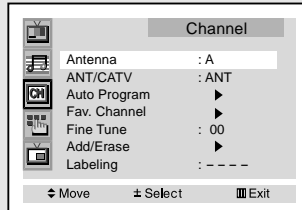

2

Press the **CH** ∇ button to select "Fav. Channel", then press the **VOL +** button.

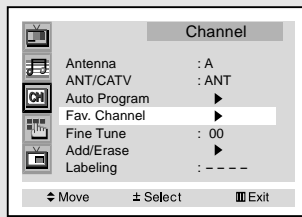

3

Press the **VOL +** or **VOL -** button to select the first channel.

To select more favorite channels, press **CH** \wedge or **CH** ∇ , then press **VOL +** or **VOL -**.

To erase the memorized Favorite Channel, select the channel by pressing the **VOL +/VOL -** buttons and then press the **Add/Erase** button.

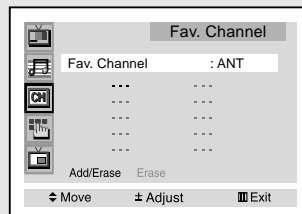

◀ Note: Only memorized channels can be set as Favorite channels.

To View Your Favorite Channels:

Press the **Fav.CH** button repeatedly to jump from one favorite channel to another.

OPERATION

Adding and Erasing Channels (Manual Method)

1

Press the **Menu** button.

Press the **CH** ∇ button to select "Channel", then press the **VOL +** button.

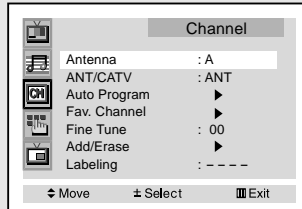

2

Press the **CH** ∇ button to select "Add/Erase", then press the **VOL +** button.

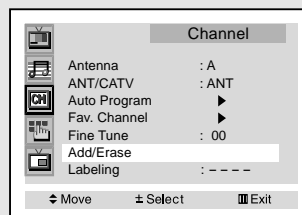

3

Press the **VOL +** button, then press **CH** \wedge / **CH** ∇ or number buttons to select the channel you want to add or erase. Press the **Menu** button.

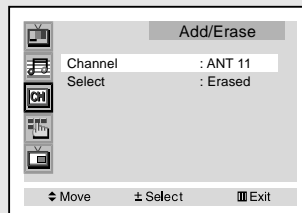

4

Press the **CH** \wedge or **CH** ∇ button to select "Select".

Press the **VOL +** or **VOL -** button to select "Added" or "Erased".

Press the **Menu** button to exit the menu.

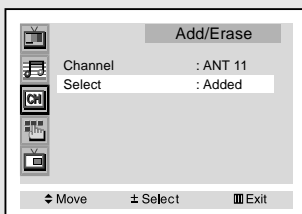

Labeling the Channels

Use this feature to assign an easy-to-remember label to any channel (i.e., “CBS”, “ESPN”, “PBS2”, CNN1”, etc.) A label consists of four fields, where each field is a letter, a number, “*”, or a blank. When the DISPLAY button is pressed, the channel label will appear next to the channel number.

1

Press **CH[^]** or **CH^v** to tune to the channel that will be labeled.

2

Press the **Menu** button.

Press the **CH^v** button to select “Channel”, then press the **VOL +** button.

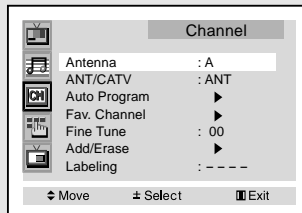

◀ Note: You cannot select “Labeling” in the A/V mode.

3

Press the **CH^v** button to select “Labeling”.

Press the **VOL +** button to begin labeling. The left-most field will be highlighted. (Each label has four fields. See top paragraph.)

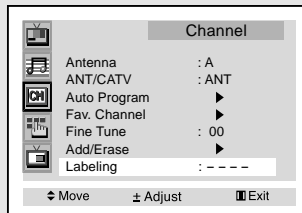

4

Press the **CH[^]** or **CH^v** button to select a letter, a number, or a blank. (Press the **CH[^]** or **CH^v** button results in this sequence: A,B,...Z, blank, 0,1,...9).

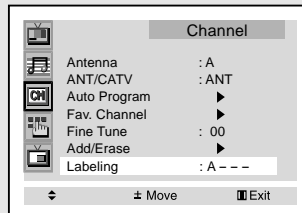

5

Press the **VOL +** button switch to the next field, which will be highlighted. Select a second letter or digit pressing the **CH[^]** or **CH^v** button, as above. Repeat the process to select the last two digits.

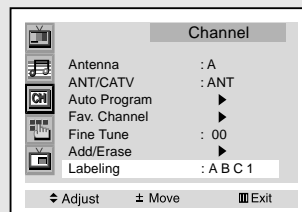

Press the **Menu** button to exit the menu.

Picture Control

You can use the on-screen menus to change the contrast, brightness, tint, color, and sharpness according to personal preference. (Alternatively, you can use one of the “automatic” settings. See next page.)

Customizing the Picture

1

Press the **Menu** button.

The “Picture” icon will be highlighted, then press the **VOL +** or **VOL -** button repeatedly, until the word “Custom” is selected.

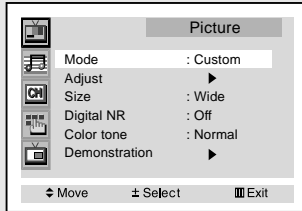

2

Press the **CH ∨** button to select “Adjust”, then press the **VOL +** button.

(The words Contrast, Brightness, Sharpness, Color, and Tint will appear on the screen.)

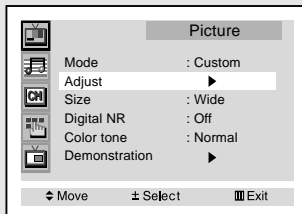

3

Press the **VOL +** button.

(The words Contrast, Brightness, Sharpness, Color, and Tint will appear on the screen.) Press the **CH ∧** or **CH ∨** button to select a particular item.

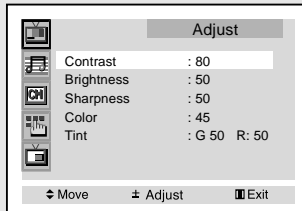

4

Press the **VOL +** or **VOL -** button to increase or decrease the value of a particular item.

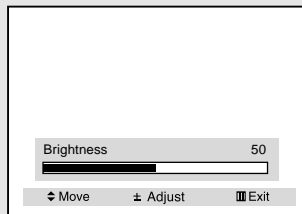

◀ After adjusting an item, the gauge will automatically disappear (after about 4 seconds).

OPERATION

Using Automatic Picture Settings

Your TV has three automatic picture settings (“Dynamic”, “Standard” and “Movie”) that are preset at the factory. You can activate either Dynamic, Standard or Movie by pressing PMode (or by making a selection from the menu). Or, you can select “Custom” which automatically recalls your personalized picture settings.

1

Press the **Menu** button.
Picture icon will be high-
lighted.

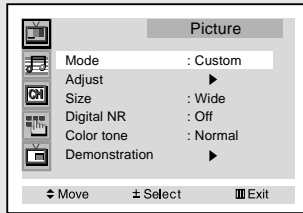

2

Press the **VOL +** or **VOL -**
button to select the
“Custom”, “Dynamic”,
“Standard” or “Movie”
picture setting.

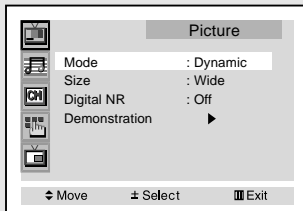

Alternate method:
Simply press the **P.Mode**
button on the remote
control to select one of
the standard picture
settings.

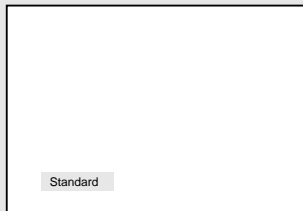

- Choose *Standard* for the standard factory settings.
- Choose *Dynamic* for viewing the TV during the day or when there is bright light in the room.
- Choose *Movie* when viewing the Movie.
- Choose *Custom* if you want to adjust the settings according to personal preference (see “Customizing the Picture, page 3.14).

OPERATION

Selecting the Color Tone

1

Press the **Menu** button.

The "Picture" icon will be highlighted. Then press the **VOL +** button.

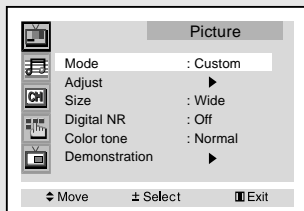

2

Press the **CH** button to select "Color Tone".

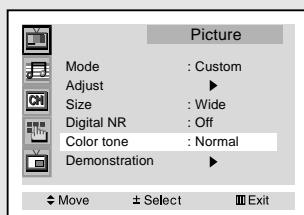

3

Press the **VOL +** or **VOL -** button to select "Normal", "Warm1", "Warm2", "Cool2" or "Cool1".

Press the **Menu** button to exit.

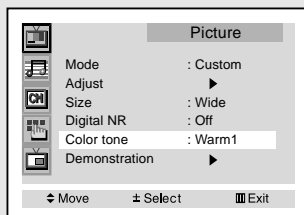

Sound Control

Adjusting the Volume

Press the **VOL +** or **VOL -** buttons to increase or decrease the volume.

Using Mute

At any time, you can temporarily cut off the sound using the Mute button.

1

Press the **Mute** button and the sound cuts off. The word "Mute" will appear in the lower-left corner of the screen.

2

To turn mute off, press the **Mute** button again, or simply press either the **VOL -** or **VOL +** button.

OPERATION

Customizing the Sound

The sound settings can be adjusted to suit your personal preferences.
(Alternatively, you can use one of the “automatic” settings. See next page.)

1

Press the **Menu** button.

Press the **CH** ∇ button to select “Sound”, the press the **VOL +** button.

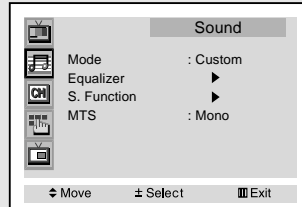

2

Press the **VOL +** or **VOL -** button repeatedly, until the word “Custom” is selected. (When Custom is selected, the words “Equalizer” will appear on the screen.)

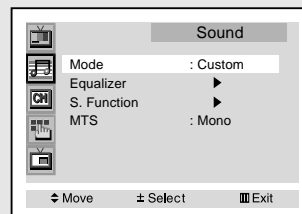

3

Press the **CH** ∇ button to select “Equalizer”, then press the **VOL+** button.

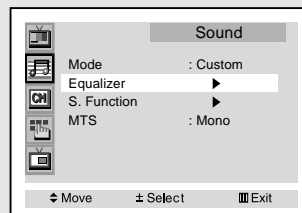

4

Press the **VOL +** or **VOL -** button to highlight a particular item to be changed.

Press the **CH** \wedge or **CH** ∇ button to increase or decrease the value of a particular item.

Press the **Menu** button exit.

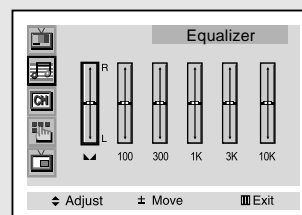

Using Automatic Sound Settings

Your TV has four automatic sound settings (“Standard,” “Music,” “Movie,” and “Speech”) that are preset at the factory. You can activate either Standard, Music, Movie or Speech by pressing the S.MODE button (or by making a selection from the menu). Or, you can select “Custom,” which automatically recalls your personalized sound settings.

1

Press the **Menu** button.

Press the **CH** ∇ button to select the “Sound”, then press the **VOL +** button.

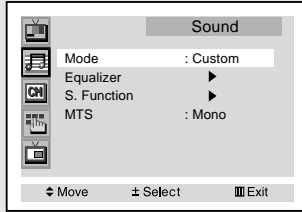

2

Press the **VOL -** or **VOL +** button repeatedly to select the “Standard,” “Music,” “Movie,” “Speech” or “Custom” sound settings.

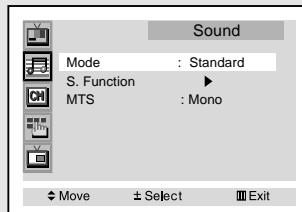

Alternate method:

Simply press the **S.MODE** button on the remote control to select one of the standard sound settings.

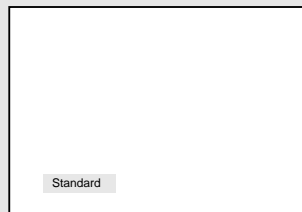

- Choose *Standard* for the standard factory settings.
- Choose *Music* when watching music videos or concerts.
- Choose *Speech* when watching a show that is mostly dialogue (i.e., news).
- Choose *Movies* when watching movies.
- Choose *Custom* to recall your personalized settings.

Setting the Clock

Setting the clock is necessary in order to use the various timer features of the TV. Also, you can check the time while watching the TV. (Just press Display.)

1

Press the Menu button.

Press the **CH** ∇ button to select "Function", then press the **VOL** + button.

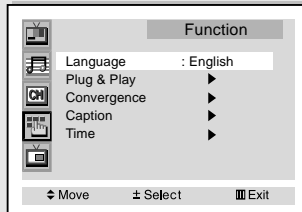

2

Press the **CH** ∇ button to select "Time" menu.

Press the **VOL** + button: The Time menu will appear on the screen, and "Clock" will be highlighted.

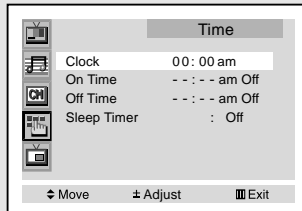

3

Press the **VOL** + button again (the hours digits will be highlighted). Press the **CH** \wedge or **CH** ∇ button repeatedly until the correct hour appears.

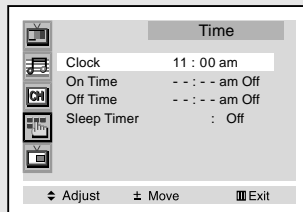

◀ When selecting the hours, be sure to select the proper time of day (AM or PM).

4

After the hour is entered, Press the **VOL** + button. (at this point the minutes digits will be highlighted). Press the **CH** \wedge or **CH** ∇ button to select the correct minutes.

After selecting the correct minutes, press the **VOL** + button.

Press the **Menu** button to exit.

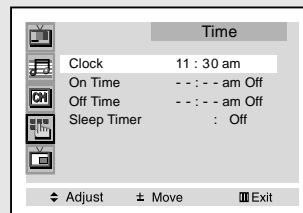

◀ The time will appear every time you press the Display button.

OPERATION

Viewing an External Signal Source

Use the remote control to switch between viewing signals from connected equipment, such as VCRs, DVD, Set-Top box and the TV source (broadcast or cable).

1

Press the TV/Video button. You will switch between viewing the signals coming from equipment connected to the TV's A/V jacks, and the TV signal.

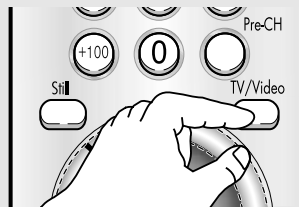

When you connect equipment to the TV, you can choose between the following sets of jacks : Video 1, Video 2, S-Video 1, Component 1 or Component 2 on the TV's rear panel, and Video 3 or S-Video 2 on the TV's side panel.

Chapter Four

SPECIAL FEATURES

Fine Tuning Channels

Use fine tuning to manually adjust a particular channel for optimal reception.

1

Select the appropriate channel.

Press the **Menu** button.
Press the **CH ∨** button to select the "Channel", then press the **VOL +** button.

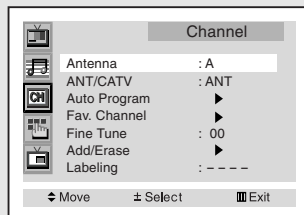

2

Press the **CH ∨** button to select "Fine Tune".

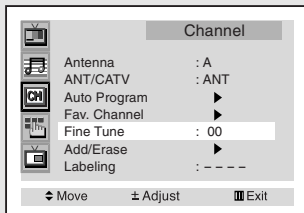

3

Press the **VOL +** or **VOL -** button to adjust the fine tuning.

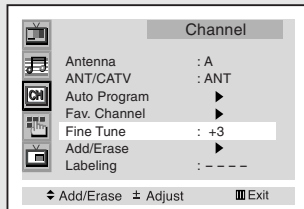

◀ After you adjust the fine tuning, "*" will appear when you press Display while watching this channel.

4

To store the fine tuning setting in the TV's memory, press the **CH ^** button. (A star icon<*>will appear.)

To reset the fine tuning to "00", press the **CH ∨** button.

Press the **Menu** button to exit.

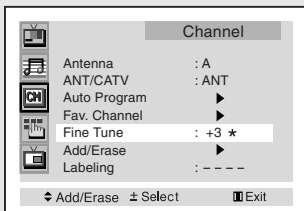

Digital Noise Reduction

If the broadcast signal received by your TV is weak, you can activate the Digital Noise Reduction feature to help reduce any static and ghosting that may appear on the screen.

1

Press the **Menu** button.

Press the **CH** ∇ button to select "Picture", then press the **VOL +** button.

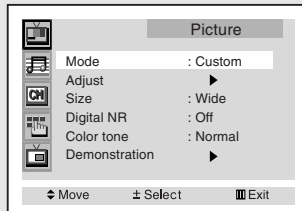

2

Press the **CH** ∇ button to select "Digital NR".

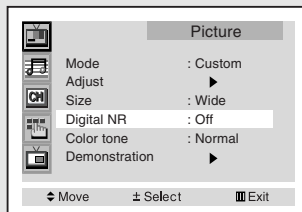

3

Press the **VOL +** or **VOL -** button to select "On".

Press the **Menu** button to exit.

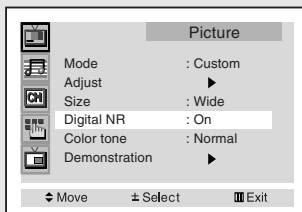

Changing the Screen Size

Press the **Aspect** button to change the screen.

4:3 TV

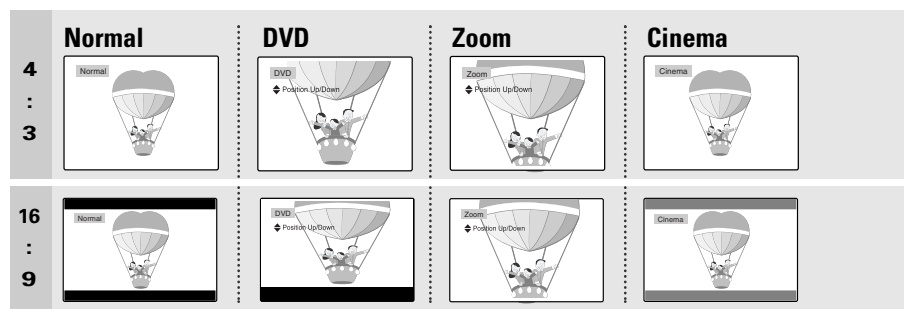

Wide TV (16:9)

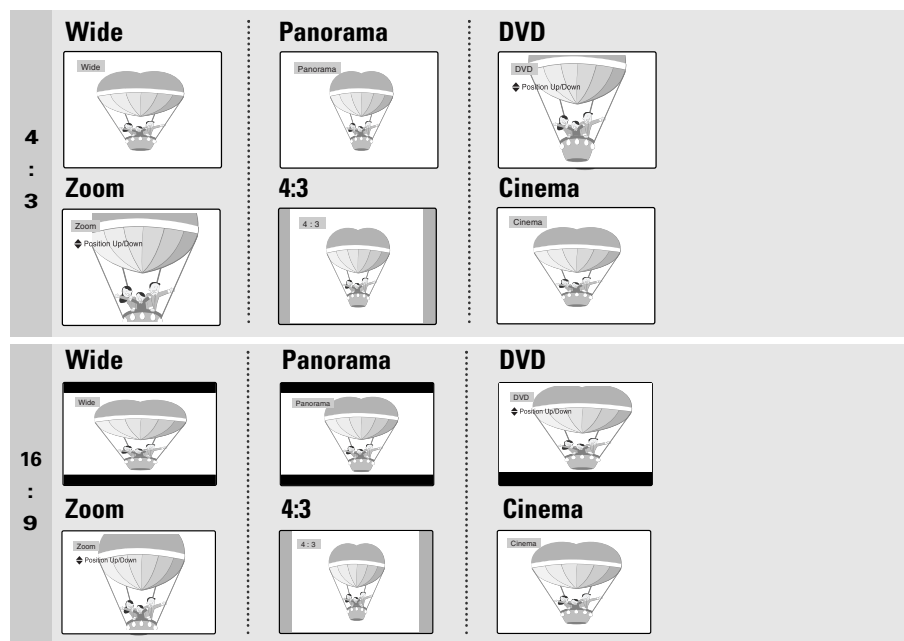

- **Wide:** Sets the picture to 16:9 wide mode.
- **Panorama:** Use this mode for the wide aspect ratio of a panoramic picture.
- **DVD:** Magnifies the size of the picture and moves the magnified picture up. You can also move the picture on screen pressing the **CH** \wedge or **CH** \vee button.
- **Zoom:** Magnifies the size of the picture on screen. You can also move the picture on screen pressing the **CH** \wedge or **CH** \vee button.
- **4:3(Normal):** Sets the picture to 4:3 normal mode.
- **Cinema:** The broadcasting signal is enlarged automatically to optimum screen size. The margins appear grayed. ST43T8PC, ST54T8PC, ST62T8PC have no change in screen size and only margins will turn gray.

Notes

- Changing the Screen size doesn't work with Component1, 2, 3(480p) signals. The ST43T8PC, ST54T8PC, ST62T8PC models operate only Zoom function with Component1, 2 (1080i) signals.
- Screen size cannot be changed in the PIP mode.
- It's possible to be a little difference to perform a grey letterbox by the specification of the DVD or VCR Tapes.

Using the R.surf feature

This feature allows you to set the TV to return to a particular channel after a certain amount of time. For example, you may be watching a channel when commercials start. You can set the R.Surf to “5 minutes”, then switch channels. After 5 minutes, the TV will return to the original channel. To use the R.surf:

1

While you are watching the channel to which you want to return, press the **R.surf** button. The on-screen display will read “Surf off”.

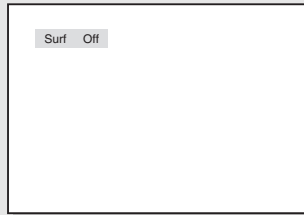

2

Press the **R.surf** button again to set the timer in thirty second intervals, up to five minutes.



3

The time you set will begin counting down on the screen. When the time runs out, the TV will return to the channel you were watching when you set the timer.

Setting the On/Off Timer

1

Press the **Menu** button.

Press the **CH** ∇ button to select "Function", then press the **VOL +** button.

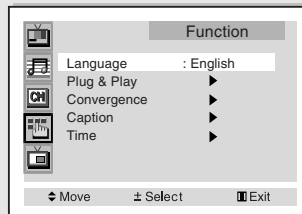

◀ Before using the timer, you must set the TV's clock. (See "Setting the Clock" on page 3.19)

When any of the timers are set, the "Timer" LED will illuminate (front panel of TV).

2

Press the **CH** ∇ button to select "Time", then press the **VOL +** button.

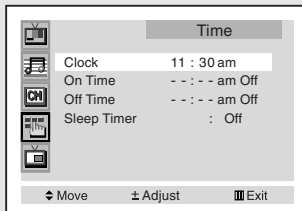

3

Press the **CH** ∇ button to select "On time".

Press the **VOL +** button to select the "On time" hours. (The hours digits will be highlighted.)

Press the **CH** \wedge or **CH** ∇ button repeatedly to select the appropriate hours (i.e., the hour when the TV will turn on.)

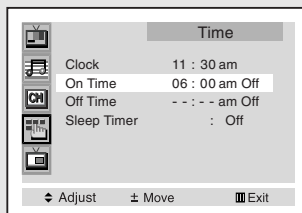

◀ When you set the hours, make sure the correct time of day (AM or PM) appears to the left of the hour.

4

Press the **VOL +** button to select the "On time" minutes. (The minutes digits will be highlighted.)

Press the **CH** \wedge or **CH** ∇ button to select the appropriate minutes.

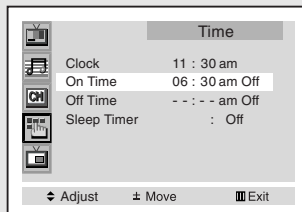

SPECIAL FEATURES

5

Press the **VOL +** button to select "On/Off."

Press the **CH ^** or **CH v** button to turn the on-timer "On." (Repeatedly pressing the **CH ^** or **CH v** button will alternate between on and off.)

When finished, press the **VOL +** button.

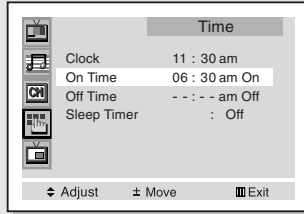

◀ To deactivate the "On time," select "Off" during this step.

6

To set the Off time, press the **CH v** button to select "Off time."

Press the **VOL +** button and set the hours and minutes. (Follow the same procedure as in steps 1-6 above.)

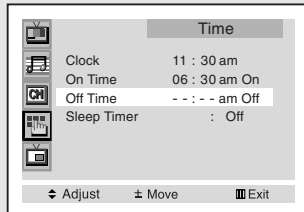

◀ If no function buttons (including remote control buttons or front panel buttons) are operated for three hours after the TV is turned on with the by "On time" feature, the TV will be automatically turned off.

7

When finished setting the timer, press the **Menu** button to exit.

Setting the Sleep Timer

The sleep timer automatically shuts off the TV after a preset time (from 10 to 180 minutes).

1

Press the **Sleep** button on the remote control.

2

Press **Sleep** repeatedly until the appropriate time interval appears (any of the preset values from "Off" to "180").

◀ After about 5 seconds, the sleep display will disappear from the screen, and the time interval will be set.

Extra sound settings (Surround, Auto Volume, Melody, BBE)

The following sound settings can be adjusted to suit your personal preferences.

1

Press the **Menu** button.

Press the **CH** ∇ button to select "Sound", then press the **VOL** + button.

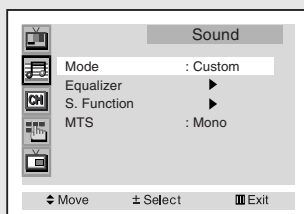

◀ Before using the timer, you must set the TV's clock. (See "Setting the Clock" on page 3.19)

When any of the timers are set, the "Timer" LED will illuminate (front panel of TV).

2

Press the **CH** ∇ button to select "S. Function", then press the **VOL** + button.

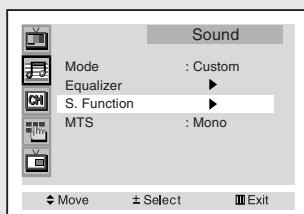

3

Press the **CH** \wedge or **CH** ∇ button to select the required item, then press the **VOL** + button to select "On".

Press the **Menu** button to exit

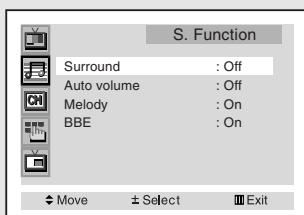

- **Surround**

Your Samsung TV can create a "surround" effect such that the sound seems to come from all directions. Once the "Surround" is set to "On", the setting applies to sound effects such as Standard, Music, Movie and Speech.

- **Auto Volume**

Each broadcasting station has its own signal conditions, which can make it necessary to adjust the volume every time the channel is changed. "Auto volume" lets you automatically adjust the volume of the desired channel by lowering the sound output when the modulation signal is high or by raising the sound output when the modulation signal is low.

- **Melody**

You can hear clear a melody sound when the TV is powered on or Off.

- **BBE**

BBE is a built-in effect that adds clarity, punch and dynamics to the sound.

Choosing a Multi-Channel Sound (MTS) Soundtrack

Depending on the particular program being broadcast, you can listen to stereo, mono, or a Separate Audio Program. (SAP audio is usually a foreign-language translation. Sometimes SAP has unrelated information like news or weather.)

1

Press the **Menu** button.

Press the **CH** ∇ button to select "Sound", then press the **VOL +** button.

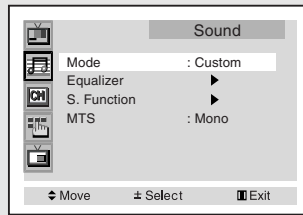

◀ Quick way to access the MTS menu: Just press the "MTS" button on the remote control.

2

Press the **CH** ∇ button to select "MTS", then Press the **VOL +** or **VOL -** button to select "Mono," "SAP," or "Stereo."

Press the **Menu** button to exit

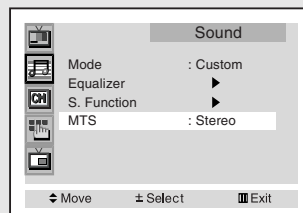

◀ The text at the bottom of the menu tells you if the incoming audio is Stereo, SAP, or Mono.

- Choose *Stereo* for channels that are broadcasting in stereo.
- Choose *Mono* for channels that are broadcasting in mono, or if you are having difficulty receiving a stereo signal.
- Choose *SAP* to listen to the Separate Audio Program, which is usually a foreign-language translation.

Viewing Closed Captions

Your TV decodes and displays the closed captions that are broadcast with certain TV shows. These captions are usually subtitles for the hearing impaired or foreign-language translations. All VCRs record the closed caption signal from television programs, so home-recorded video tapes also provide closed captions. Most pre-recorded commercial video tapes provide closed captions as well. Check for the closed caption symbol in your television schedule and on the tape's packaging: .

1

Press the **Menu** button.

Press the **CH** ∇ button to select "Function", then press the **VOL +** button.

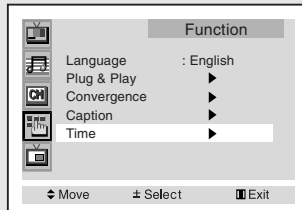

◀ Quick way to access captions menu: Simply press the "Caption" button on the remote control:

2

Press the **CH** ∇ button to select "Caption", then press the **VOL +** button.

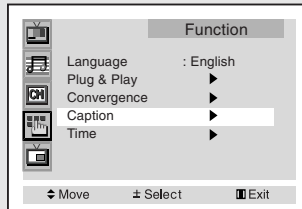

3

Press the **VOL +** or **VOL -** button to turn closed captioning "on" or "off".

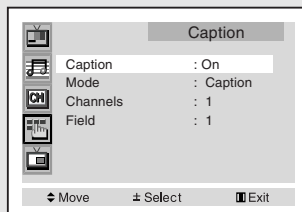

◀ Misspellings and unusual characters sometimes occur during closed caption transmissions, especially those of live events. There may be a small delay before captions appear when you change channels. These are not malfunctions of the TV.

4

Press the **CH** ∇ button to select "Mode", then press the **VOL +** or **VOL -** button to select "Caption" or "Text."

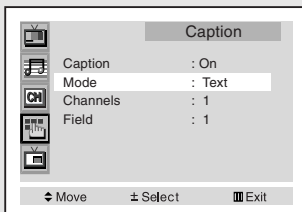

◀ In **caption mode**, captions appear at the bottom of the screen, and they usually cover only a small portion of the picture.

In **text mode**, information unrelated to the program, such as news or weather, is displayed. Text often covers a large portion of the screen.

5

Depending on the particular broadcast, it might be necessary to make changes to "Channels" and "Field": Use the **CH** \wedge , **CH** ∇ , **VOL +** and **VOL -** buttons to make the changes. (Follow the same procedure as in steps 3~4 above.)

Press the **Menu** button to exit.

◀ Different channels and fields display different information: Field 2 carries additional information that supplements the information in Field 1. (For example, Channel 1 may have subtitles in English, while Channel 2 has subtitles in Spanish.)

Note: The Caption feature doesn't work in Component1(480p, 1080i), Component2 or Component3 mode.

Viewing Picture-in-Picture

You can use the PIP feature to simultaneously watch two video sources.

Note: The PIP feature does not work with Component1, Component2, Component3 mode. When PIP is selected in the Zoom mode, the Mode is automatically converted into the Normal mode.

Activating Picture-in-Picture

1

Press the **Menu** button.

Press the **CH** ∇ button to select "PIP", then press the **VOL +** button.

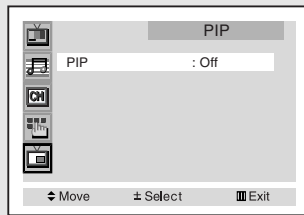

◀ Quick way to access the PIP menu: Simply press the "PIP" button on the remote control.

2

Press the **VOL +** or **VOL -** button to select PIP "On".

Press the **Menu** button to exit.

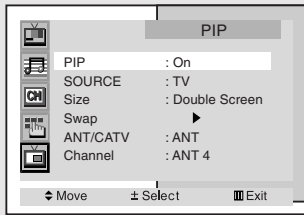

◀ If you turn TV off while watching and turn it on again, the PIP window will disappear.

Notes

- Picture-in-Picture doesn't function when the V-chip is active.
- Screen size cannot be changed in the PIP mode.
- The PIP feature doesn't work with Component1 or Component2, 3 signals.
- When the cable box output is connected to ANT-B, it cannot be viewed in the PIP window.
- Double Window isn't available on models ST42W5P / ST43T8PC / ST54T8PC / ST62T8PC.

Selecting a Signal Source (Antenna or Cable) for PIP

1

Press the **Menu** button.

Press the **CH** ∇ button to select "PIP", then press the **VOL +** button.

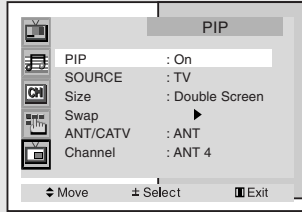

2

Press the **CH** ∇ button to select "ANT/CATV."

If an antenna is connected, the setting is "ANT."

If a Cable TV system is providing the signal, press the **VOL +** or **VOL -** button until the appropriate type of cable system is displayed ("STD," "HRC," or "IRC").

Press the **Menu** button to exit.

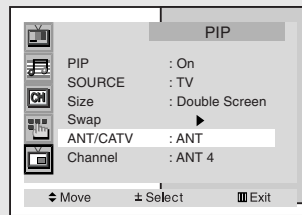

Selecting a Signal Source (External A/V) for PIP

1

Press the **Menu** button.

Press the **CH** ∇ button to select "PIP", then press the **VOL +** button.

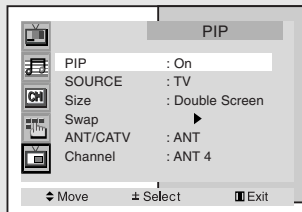

◀ Quick way to access the signal source (PIP): Simply press the "Source" button on the remote control.

2

Press the **CH** ∇ button to select "SOURCE", then press the **VOL +** or **VOL -** button to cycle through all of the available signal sources: "TV", "Video 1", "Video 2", "Video 3", "S-Video 1", and "S-Video 2".

Press the **Menu** button to exit.

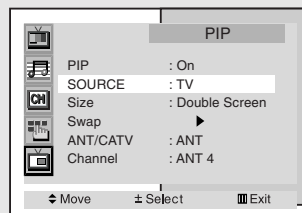

◀ If you select "TV", the PIP image is the same as the main image.

SPECIAL FEATURES

Swapping the Contents of the PIP Image and Main Image

1

Press the **Menu** button.

Press the **CH** ∇ button to select "PIP", then press the **VOL +** button.

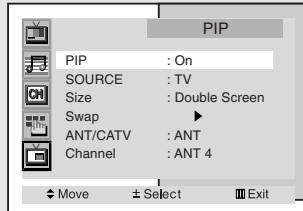

◀ Quick way to access swapping: Simply press the "Swap" button on the remote control.

2

Press the **CH** ∇ button to select "Swap," then press the **VOL +** or **VOL -** button

The image in the PIP window will appear on the main screen, and vice versa.

Press the **Menu** button to exit.

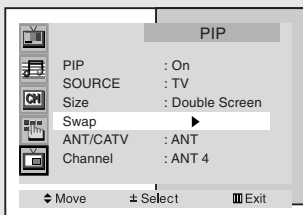

Note: When ANT-B is selected, the PIP Swap function doesn't work.

Changing the Size of the PIP Window

1

Press the **Menu** button.

Press the **CH** ∇ button to select "PIP", then press the **VOL +** button.

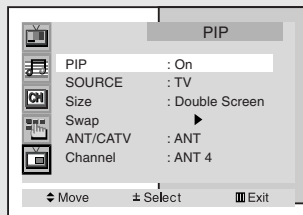

◀ Quick way to access PIP size: Simply press the "Size" button on the remote control.

2

Press the **CH** ∇ button to select "Size," then press the **VOL +** or **VOL -** button to select the "Small", "Double Screen", "Large", "Stock Ticker", "4 Pictures" or "13 Pictures".

Press the **Menu** button to exit.

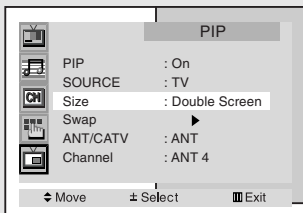

◀ ST42W5P / ST43T8PC / ST54T8PC / ST62T8PC : Large, Small, Stock Ticker

ST47W3PC / ST55W3PC / ST65W3PC : Double Screen, Large, Small, Stock Ticker, 4 Pictures, 13 Pictures.

Changing the PIP Channel

1

Press the **Menu** button.

Press the **CH** ∇ button to select "PIP", then press the **VOL +** button

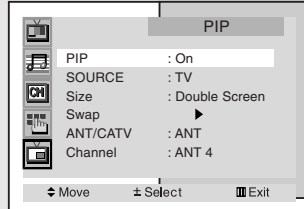

◀ Quick way to access PIP CH:
Simply press the (PIP) "CH" button
on the remote control.

2

Press the **CH** ∇ button to select "Channel," then press the **VOL +** or **VOL -** button to change the channel that appears in the PIP window.

Press the **Menu** button to exit.

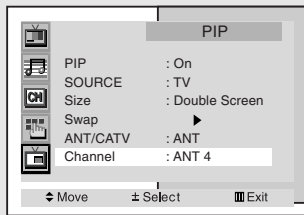

Note: The PIP channels are not available when RF is set to ANT-B. (The PIP channels link to ANT-A).

Changing the Location (Rotating) in PIP mode

When you press the **Locate** button repeatedly, the PIP window moves from corner to corner on the TV screen.

Scanning the Available Channels

This procedure scans all of the available channels and then stores them in memory.

Press the **Scan** button, and the memorized channels will appear in sequence for 2 to 3 seconds per channel.
Press the **Scan** button again to stop the scanning process.

When Scan stops, the viewing mode will return to its original setting.

Viewing the Demonstration

To become familiar with the various menus provided by your television, you can view the built-in demonstration.

1
Press the **Menu** button.

Picture icon will be highlighted (blinking).

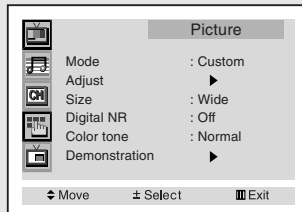

2
Press the **CH** ∇ button to select "Demonstration", then press the **VOL+** button.

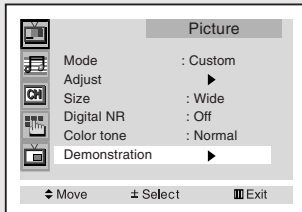

3
Each of the menu options is displayed in turn. When you wish to stop the demonstration, press any button on the remote control.

Press the **Menu** button to exit.

Note:
The Component3 jack is available on ST47W3PC / ST55W3PC / ST65W3PC.

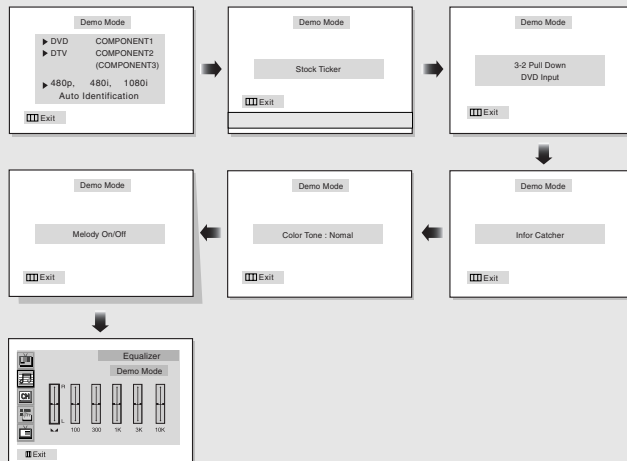

Customizing Your Remote Control

Your TV comes equipped with a “universal” remote control. In addition to controlling the TV, the universal remote can also operate most VCRs, DVDs and cable boxes (even if your VCR, cable box or DVD are made by manufacturers other than Samsung).

Setting Up Your Remote Control to Operate Your VCR (or DVD)

1

Turn off your VCR (or DVD.)

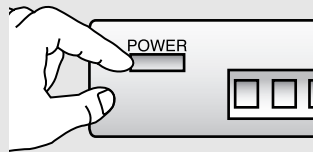

2

Press the **MODE** button and make sure that the **VCR (or DVD)** LED is illuminated.

◀ The remote control has four “modes”: “TV,” “VCR,” “Cable” and “DVD.” Press the “MODE” button to switch the remote control to the “VCR” (or DVD) mode.

3

On your Samsung remote control, press **Set**.

4

Enter 3 digits of the VCR (or DVD) code listed on page 4.22 for your brand of VCR (or DVD).

◀ Make sure you enter 3 digits of the code, even if the first digit is a “0.”

If more than one code listed, try the first one.

5

Press the **Power** button on the remote control. Your VCR (or DVD) should turn on. If your VCR (or DVD) turns on, your remote control is now set correctly.

◀ If your VCR (or DVD) does not turn on, repeat steps 2, 3, and 4, but try one of the other codes listed for the brand of your particular VCR (or DVD).

If no other codes are listed, try each code, 000 through 089.

6

Once your remote control is set up, press the **MODE** button any time you want to use the remote to operate your VCR (or DVD).

◀ When your remote control is in the “VCR” (or DVD) mode, the volume buttons still control your TV’s volume.

When your remote is in the “TV” mode, the VCR control buttons (PLAY, PAUSE, etc.) will still operate your VCR.

Setting Up Your Remote Control to Operate Your Cable Box

- 1**
Turn off your cable box.

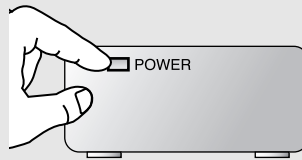

- 2**
Press the **MODE** button and make sure that the **Cable** LED is illuminated.

◀ The remote control has four “modes”: “TV,” “VCR,” “CABLE” and “DVD.”

Press the “MODE” button to switch the remote control to the “Cable” mode.

- 3**
On your Samsung remote control, press **SET**.

- 4**
Enter 3 digits of the cable box code listed below for your brand of cable box.

◀ Make sure you enter 3 digits of the code, even if the first digit is a “0.” (If more than one code listed, try the first one.)

- 5**
Press **Power**. Your cable box should turn on. If your cable box turns on, your remote control is now “set up” correctly.

◀ If your cable box does not turn on, repeat steps 2, 3, and 4, but try one of the other codes listed for your particular brand of cable box. (If no other codes are listed, try each cable box code, 000 through 077.)

- 6**
Once your remote control is set up, press the **MODE** button any time you want to use the remote to operate your cable box.

◀ When your remote control is in the “CABLE” mode, the volume buttons still control your TV’s volume. Also, the VCR control buttons (PLAY, PAUSE, etc.) will still operate your VCR.

SPECIAL FEATURES

VCR Codes

Admiral	006, 079	KLH	073	RCA	000, 005, 007, 008, 028, 035, 037, 054, 069
Aiwa	015	LG	009, 014, 046, 060	Samsung	007, 013, 022, 032, 042, 077
Akai	017, 022, 023, 027, 030	Lloyd	015	Sansui	016
Audio Dynamics	014, 016	Logik	031	Sanyo	002, 012
Bell & Howell	002	LXI	015	Scott	013, 041, 049, 068
Broksonic	010	Magnavox	008, 029, 053, 056	Sears	002, 005, 009, 012, 018, 019, 035, 043, 048
Candle	007, 009, 013, 045, 046, 052	Marantz	002, 008, 014, 016, 029, 030, 046, 061	Sharp	006, 027, 039, 045
Cannon	008, 053	Marta	009	Shintom	017, 026, 031, 055
Citizen	007, 009, 013, 045, 046, 052	MEI	008	Signature	015
Colortyme	014	Memorex	008, 009, 012, 015	Sony	017, 026, 038
Craig	007, 012	MGA	027	Sylvania	008, 015, 029, 053, 056
Curtis-Mathes	000, 007, 008, 014, 015, 046, 053, 064, 067	Midland	032	Symphonic	015
Daewoo	013, 045, 076	Minota	005, 035	Tandy	002, 015
DBX	014, 016	Mitsubishi	005, 027, 035, 040	Tashiko	009
Dimensia	000	Montgomery ward	006	Tatung	030
Dynatech	015	MTC	007, 015	Teac	015, 030, 069
Electrohome	027	Multiotech	007, 015, 031, 032	Technics	008
Emerson	008, 009, 010, 013, 015, 020, 023, 027, 034, 041, 042, 047, 049, 057, 062, 065, 067, 068, 070	NEC	002, 014, 016, 030, 046, 061, 064	Ternika	008, 009, 015, 021
Fisher	002, 012, 018, 019, 043, 048, 058	Optimus	006	TMK	067
Funai	015	Panasonic	008, 053, 075, 077	Toshiba	005, 013, 019, 048, 049
GE	000, 007, 008, 032, 053	Pentax	005, 035	Totevision	007, 009
Go Video	007	Pentex Reserch+	046	Unitech	007
Harman Kardon	014	Philco	008, 029, 053, 056	Vector Research	014, 016
Hitachi	005, 015, 035, 036	Philips	008, 029	Victor	016
Instant Replay	008	Pioneer	005, 016, 033, 050	Video Concepts	014, 016
JC Penney	002, 005, 007, 008, 014, 016, 030, 035, 051, 053	Portland	044, 045, 052	Videosonic	007
JCL	008, 002, 014, 016, 030, 046	ProScan	000	Wards	005, 006, 007, 008, 009, 012, 013, 015, 027, 031, 035
JVC	002, 014, 088, 089	Quartz	002	Yamaha	002, 014, 016, 030, 046
Kenwood	002, 014, 016, 030, 046	Quasar	008, 053	Zenith	011, 017, 026, 079
		Radio Shack/Realistic	002, 006, 008, 009, 012, 015, 019, 027, 045, 053		

Cable Box Codes

Anvision	007, 008	NSC	009	Signature	046
Cablestar	007, 008	Oak	016, 038	Sprucer	027
Eagle	007, 008	Osk Sigma	016	Starcom	046
Eastern Int.	002	Panasonic	003, 027, 039, 061, 073, 074	Stargate 2000	058
General Instrument	046	Philips	007, 008, 019, 021, 026, 028, 029, 032, 033, 040, 041	Sylvania	011, 059
GI	004, 005, 015, 023, 024, 025, 030, 036, 067, 068, 069	Pioneer	018, 020, 044, 074, 077	Texscan	011, 059
Hamlin	003, 012, 013, 034, 048	Randtek	007, 008	Tocom	017, 021, 049, 050, 055, 073
Hitachi	037, 043, 046	RCA	000, 027, 066	Unika	031, 032, 041
Jerrold	004, 005, 015, 023, 024, 025, 030, 036, 046, 062, 065	Regal	003, 012, 013	Universal	051, 052
Macom	037, 043	Regency	002, 033	Viewster	007, 008, 019, 021, 026, 028, 029, 032, 033, 040, 041
Magnavox	007, 008, 019, 021, 026, 028, 029, 032, 033, 040, 041	SA	070, 071, 072	Warner Amex	044
		Samsung	044, 003, 022, 063, 064	Zenith	014, 042, 057, 061, 075, 076

DVD Codes

Philips	001
Proscan	002
RCA	002
Toshiba	003
Panasonic	004
Sony	008
Samsung	000

Note: The remote control might not be compatible with all DVD Players, VCRs, and Cable boxes.

Chapter Five

TROUBLESHOOTING

If the TV seems to have a problem, first try this list of possible problems and solutions. If none of these troubleshooting tips apply, then call your nearest service center.

Identifying Problems

Problem	Possible Solution
Poor picture.	Try another channel. Adjust the antenna. Check all wire connections.
Poor sound quality.	Try another channel. Adjust the antenna.
No picture or sound.	Try another channel. Press the TV/Video button. Make sure the TV is plugged in. Check the antenna connections.
No color, wrong colors or tints.	Make sure the program is broadcast in color. Adjust the picture settings.
Picture rolls vertically.	Adjust the antenna. Check all wire connections.
The TV operates erratically.	Unplug the TV for 30 seconds, then try operating it again.
Your remote control does not operate your TV.	Press the "MODE" button to put your remote control in the "TV" mode.
The TV won't turn on.	Make sure the wall outlet is working.

Note

Wide TV(16:9): If you watch a still image or the screen in the Normal(4:3) aspect ratio format for a long time, images may be burned onto the screen.

Normal TV(4:3): If you watch a still image or the screen in the Wide(16:9) aspect ratio format for a long time, images may be burned onto the screen.

Cleaning and Maintaining Your TV

With proper care, your TV unit will give you many years of service. Please follow these guidelines to get the maximum performance from your TV.

Placement

- Do not place the TV near extremely hot, cold, humid or dusty places.
- Do not place the TV near appliances with electric motors that create magnetic fields, such as vacuum cleaners.
- Keep the ventilation openings clear; do not place the TV on a soft surface, such as cloth or paper.
- Place the TV in a vertical position only.

Liquids

- Do not handle liquids near or on the TV. Liquids that spill into it can cause serious damage.

Cabinet

- Never open the cabinet or touch the parts inside.
- Wipe your TV with a clean, dry cloth. Never use water, cleaning fluids, wax, or chemicals.
- Do not put heavy objects on top of the cabinet.

Temperature

- If your TV is suddenly moved from a cold to a warm place, unplug the power cord, and allow at least two hours for moisture that may have formed inside the unit to dry completely.

Using Your TV in Another Country

If you plan to take your TV with you to a foreign country, please be aware of the different television systems that are in use around the world. A TV designed for one system may not work properly with another system due to differences in the TV channel frequencies

Specifications

Model	ST42W5P / ST47W3PC / ST55W3PC / ST65W3PC / ST43T8PC / ST54T8PC / ST62T8PC
Voltage	AC 100-240V
Frequency of Operation	50/60 Hz
Power Consumption	240 Watts
Dimensions	ST42W5P : 1002 x 450 x 1079 mm ; 39.4 x 17.7 x 42.4 inches ST47W3PC : 1132 x 588 x 1325 mm ; 44.6 x 23.1 x 52.2 inches ST55W3PC : 1312 x 651 x 1435 mm ; 51.7 x 25.6 x 56.5 inches ST65W3PC : 1529 x 736 x 1587 mm ; 60.2 x 29.0 x 62.5 inches ST43T8PC : 959 x 505 x 1110 mm ; 37.8 x 19.9 x 43.7 inches ST54T8PC : 1162 x 635 x 1525 mm ; 45.7 x 25 x 60 inches ST62T8PC : 1321 x 738 x 1694 mm ; 52 x 29.1 x 66.7 inches
Weight	ST42W5P : 49 Kg ; 108 lbs, ST47W3PC : 76 Kg ; 167.5 lbs ST55W3PC : 99.5 Kg ; 219.4 lbs, ST65W3PC : 136 Kg ; 299.8 lbs ST43T8PC : 47 Kg ; 103.6 lbs, ST54T8PC : 78 Kg ; 172 lbs, ST62T8PC : 99 Kg ; 218.3 lbs

MEMO

MEMO

Free Manuals Download Website

<http://myh66.com>

<http://usermanuals.us>

<http://www.somanuals.com>

<http://www.4manuals.cc>

<http://www.manual-lib.com>

<http://www.404manual.com>

<http://www.luxmanual.com>

<http://aubethermostatmanual.com>

Golf course search by state

<http://golfingnear.com>

Email search by domain

<http://emailbydomain.com>

Auto manuals search

<http://auto.somanuals.com>

TV manuals search

<http://tv.somanuals.com>