

FE-R700\*\*

# Electric Range

## user manual

imagine the possibilities

Thank you for purchasing this Samsung product.  
To receive more complete service, please register  
your product at  
[www.samsung.com/global/register](http://www.samsung.com/global/register)



# features of your new range

---

Enhanced convenience. Better cooking. Easy maintenance. Your new electric range has been designed to bring you these benefits and more.

- **The latest in heat-distribution technology**

Other ranges with just one fan tend to make a swirl of heat that fails to cover the whole inside of the oven. This means uneven heat distribution and uneven cooking. Your new range has Surround Airvection™, which Samsung innovated by adding a third heating element and a multi-fan system that circulates the heat evenly in all directions. You get more efficient energy consumption and more even cooking.

- **Steam Quick cleaning**

Thanks to Steam Quick™, Samsung's unique technology for light-duty cleaning jobs, keeping your oven Spic-and-Spic is a snap — no hassle, no odor, no chemicals. Steam Quick™ cleans the inside of your range with high-temperature steam in just 20 minutes.

- **Bigger is better**

With a capacity of 5.9 cubic feet, your new range is equipped with more space than any of its competitors in the U.S. market. This means greater convenience for you when cooking for the holidays or when entertaining.

- **A cooktop with 5 burners**

Four main burners with two that dial heat up to different pot sizes.

A smaller warming burner in the center of the range top.

# important safety instructions











**Read and follow all instructions before using your oven to prevent the risk of fire, electric shock, personal injury, or damage when using the range.** This guide does not cover all possible conditions that may occur. Always contact your service agent or manufacturer about problems that you do not understand.

## WHAT YOU NEED TO KNOW ABOUT SAFETY INSTRUCTIONS

Warnings and Important Safety Instructions in this manual do not cover all possible conditions and situations that may occur. It is your responsibility to use common sense, caution, and care when installing, maintaining, and operating your oven.

## IMPORTANT SAFETY SYMBOLS AND PRECAUTIONS

What the icons and signs in this user manual mean:

 <b>WARNING</b>	Hazards or unsafe practices that may result in <b>severe personal injury or death.</b>
 <b>CAUTION</b>	Hazards or unsafe practices that may result in <b>minor personal injury or property damage.</b>
 <b>CAUTION</b>	To reduce the risk of fire, explosion, electric shock, or personal injury when using your oven, follow these basic safety precautions.
	Do NOT attempt.
	Do NOT disassemble.
	Do NOT touch.
	Follow directions explicitly.
	Unplug the power plug from the wall socket.
	Make sure the machine is grounded to prevent electric shock.
	Call the service center for help.
	Note

These warning signs are here to prevent injury to you and others. Please follow them explicitly.

After reading this section, keep it in a safe place for future reference.

# ANTI-TIP DEVICE

---



**WARNING-**To reduce the risk of tipping the range, the range must be secured by a properly installed Anti-Tip device. Refer to the installation manual for instructions.



## WARNING

**ALL RANGES CAN TIP AND CAUSE INJURIES TO PERSONS**



**INSTALL THE ANTI-TIP DEVICE PACKED WITH RANGE  
FOLLOW ALL INSTALLATION INSTRUCTIONS**

- Do not step, lean, or sit on the doors of the range.** These can cause the range to tip, resulting in burns or serious injuries.
- Check to see that the Anti-Tip device is installed properly. Then grasp the top rear edge of the range and carefully attempt to tilt it forward. Verify that the Anti-Tip device is engaged.

If you pull the range out from the wall for any reason, make sure the device is properly engaged when you push the range back against the wall. If it is not, there is a possible risk of the range tipping over and causing injury if you or a child stand, sit or lean on an open door.

## FOR YOUR SAFETY

---

**When using electrical appliances, basic safety precautions should be followed, including the following:**



Use this appliance only for its intended purpose as described in this Owner's Manual.

Potentially hot surfaces include the cooktop, areas facing the cooktop, oven vent opening, surfaces near the opening, crevices around the oven door.



Be sure your appliance is properly installed and grounded by a qualified technician.



**User servicing-** Do not repair or replace any part of the appliance unless specifically recommended in the manual. All other servicing should be referred to a qualified technician.



Always disconnect power to appliance before servicing by removing the fuse or switching off the circuit breaker.

 **Do not enter inside the oven.**

**Do not store items of interest to children in cabinets above a range or on the back guard of a range.** Children climbing on the range to reach items could be seriously injured.

**Do not leave children alone.** Children should not be left alone or unattended in an area where appliance is in use. They should never be allowed to sit or stand on any part of the appliance.

**Never use your appliance for warming or heating the room.**

**Do not use water on grease fires.** Turn off the oven to avoid spreading the flame. Smother the fire or flame by closing the door or use dry chemical, baking soda, or foam-type extinguisher.

 **Storage in or on appliance.** Flammable materials should not be stored in an oven or near surface units. Be sure all packing materials are removed from the appliance before operating it. Keep plastics, clothes, and paper away from parts of the appliance that may become hot.

**Wear proper apparel.** Loose-fitting or hanging garments should never be worn while using the appliance.

**Use only dry potholders.** Moist or damp potholders on hot surfaces may result in burns from steam. Do not let the potholder touch hot heating elements. Do not use a towel or other bulky cloth.

Teach children not to play with the controls or any other part of the range.

## SURFACE COOKING UNITS

---

 **Never leave surface units unattended at high heat settings.** Boilovers cause smoking and greasy spillovers that may ignite.

**Do not lift the cooktop.** Lifting the cooktop can lead to damage and improper operation of the range.

**Do not operate the cooktop when there is no cookware.** If the cooktop operates without a cookware, the control knob will become hot.

Never use the glass cooktop surface as a cutting board.

★ **Use care when touching the cooktop.** The glass surface of the cooktop will retain heat after the controls have been turned off.

**Be careful when placing spoons or other stirring utensils on the glass cooktop surface** when it is in use. They may become hot and could cause burns.

**Use proper pan sizes.** This appliance is equipped with surface units of different size. Select utensils having flat bottoms large enough to cover the surface unit heating element. The use of undersized utensils will expose a portion of the heating element to direct contact and may result in ignition of clothing. Proper relationship of utensil to burner will also improve efficiency.

**Glazed cooking utensils.** Only certain types of glass, glass/ceramic, ceramic, earthenware, or other glazed utensils are suitable for range-top service without breaking due to the sudden change in temperature.

**Utensil handles should be turned outward and not extend over adjacent surface units.** To reduce the risk of burns, ignition of flammable materials, and spillage due to unintentional contact with the utensil, the handle of a utensil should be positioned so that it is turned outward, and does not extend over adjacent surface units.

Read and follow all instructions and warnings on the cleaning cream labels.

Be sure you know which control knob operates each surface unit. Make sure you turned on the correct surface unit.

Always turn the surface units off before removing cookware.

When preparing flaming foods under the hood, turn the fan on.

Keep an eye on foods being fried at high or medium high heat settings.

# OVEN

---

 **DO NOT TOUCH HEATING ELEMENTS OR INTERIOR SURFACES OF THE OVEN.** Heating elements may be hot even though they are dark in color. Interior surfaces of an oven become hot enough to cause burns. During and after use, do not touch or let clothing or other flammable materials contact heating elements or interior surfaces of oven until they have had sufficient time to cool. Other surfaces of the appliance may become hot enough to cause burns. Among these surfaces are oven vent openings and surfaces near these openings, oven doors, and windows of oven doors.

**Do not heat unopened food containers.** Build-up of pressure may cause the container to burst and result in injury.

**Do not use the oven to dry newspapers.** If overheated, they can catch on fire.

**Do not use the oven for a storage area.** Items stored in an oven can ignite.

 **Use care when opening door.** Let hot air or steam escape before you remove or replace food in the oven.

**Protective liners.** Do not use aluminum foil to line the oven bottoms, except as suggested in the manual. Improper installation of these liners may result in a risk of electric shock or fire.





**Keep oven vent ducts unobstructed.** The oven vent is located above the right rear surface unit. this area could become hot during oven use. Never block this vent or place plastic or heat-sensitive items on it.

**Placement of oven racks.** Always place oven racks in the desired location while the oven is cool. If the rack must be moved while the oven is hot, do not let the potholder come in contact with the hot heating element in the oven.

 Do not allow aluminum foil or a meat probe to contact heating elements.

## WARMING DRAWER

---

-  **DO NOT TOUCH THE HEATING ELEMENT OR THE INTERIOR SURFACE OF THE DRAWER.** These surfaces may be hot enough to burn.  
**REMEMBER:** The inside surface of the drawer may be hot when the drawer is opened.
-  **The purpose of the warming drawer is to hold hot cooked foods at serving temperature.** Always start with hot food; cold food cannot be heated or cooked in the warming drawer.
-  **Use care when opening the drawer.** Open the drawer a crack and let hot air or steam escape before removing or replacing food. Hot air or steam which escapes can cause burns to hands, face and/or eyes.
-  **Do not use the drawer to dry newspapers.** If overheated, they can catch on fire.

**Do not use aluminum foil to line the drawer.** Foil is an excellent heat insulator and will trap heat beneath it. This will upset the performance of the drawer and it could damage the interior finish.



Do not leave paper products, plastics, canned food or combustible materials in the drawer.

Never leave jars or cans of fat drippings in or near your drawer.

Do not warm food in the drawer for more than three hours.

## SELF-CLEANING OVENS

---

-  **Do not clean the door gasket.** The door gasket is essential for a good seal. Care should be taken not to rub, damage, or move the gasket.
-  **Never keep pet birds in the kitchen.** The health of birds is extremely sensitive to the fumes released during an oven self-clean cycle. Fumes may be harmful or fatal to birds. Move birds to a well-ventilated room.

**Clean only parts listed in this manual in the self-clean cycle.** Before self-cleaning the oven, remove the broil pan, rack, utensils, and food.

No commercial oven cleaner or oven liner protective coating of any kind should be used in or on the outside of the oven. Use only a ceramic cooktop cleaner or the cleaner supplied with this appliance on the glass cooktop.



- ★ Nickel oven shelves should be removed from the oven before beginning the self-cleaning cycle, or they may discolor.

If the self-clean mode malfunctions, turn the oven off and disconnect the power supply. Have it serviced by a qualified technician.

## VENTILATING HOOD

---

- ★ **Clean ventilating hoods frequently.** Grease should not be allowed to accumulate on the hood or filter.

**When flaming foods under the hood, turn the fan on.**

## GLASS/CERAMIC COOKING SURFACES

---

- ☐ **DO NOT TOUCH SURFACE UNITS OR AREAS NEAR UNITS.** Surface units may be hot even though they are dark in color. Areas near surface units may become hot enough to cause burns. During and after use, do not touch, or let clothing or other flammable materials contact surface units or areas near units until they have had sufficient time to cool. Among these areas are the cook-top and facing the cook-top.

**Do not cook on broken cooktop.** If cooktop should break, cleaning solutions and spillovers may penetrate the broken cook-top and create a risk of electric shock. Contact a qualified technician immediately.

- ★ **Clean cooktop with caution.** If a wet sponge or cloth is used to wipe spills on a hot cooking area, be careful to avoid steam burn. Some cleaners can produce noxious fumes if applied to a hot surface.

## BEFORE YOU BEGIN

---

- ★ **Clean the oven thoroughly before using for the first time.** Remove accessories and operate the oven at the bake setting at 400°F for 1 hour before using. There will be a distinctive odor; this is normal, but ensure your kitchen is well ventilated during this conditioning period.



## SEVERE WARNING SIGNS FOR INSTALLATION

---

- The installation of this appliance must be performed by a qualified technician or service company.

- Failing to do so may result in electric shock, fire, an explosion, problems with the product, or injury.

Unpack the oven, remove all packaging material and examine the oven for any damages such as dents on the interior or exterior of the oven, broken door latches, cracks in the door, or a door that is not lined up correctly. If there is any damage, do not operate the oven and notify your dealer immediately.

Plug the power cord into a properly grounded outlet of standard. Your oven should be the only connected on this circuit.

Keep all packaging materials out of the reach of children. Children may use them for play.

Install your appliance on a level and hard floor that can support its weight.

- Failing to do so may result in abnormal vibrations, noise, or problems with the product.

- This appliance must be properly grounded.

Do not ground the appliance to a gas pipe, plastic water pipe, or telephone line.

- This may result in electric shock, fire, an explosion, or problems with the product

Do not cut or remove the ground prong from the power cord under any circumstances.

Connect the oven to a properly grounded circuit

- Do not install this appliance in a humid, oily or dusty location, in a location exposed to direct sunlight and water (rain drops).

- This may result in electric shock or fire.

Do not use a damaged power cord or loose wall socket.

- This may result in electric shock or fire.

Do not operate any other heating or cooking appliance beneath this appliance.

Do not mount unit over or near any portion of a heating or cooking appliance.

Do not mount over a sink.

Do not pull or excessively bend the power cord.

Do not twist or tie the power cord.

Do not hook the power cord over a metal object, place a heavy object on the power cord, insert the power cord between objects.

- This may result in electric shock or fire.

- When the power cord is damaged, contact your nearest service center.



## SEVERE WARNING SIGNS FOR USING

---

- If the appliance is flooded please contact your nearest service center : Failing to do so may result in electric shock or fire.

If the appliance generates a strange noise, a burning smell or smoke, unplug the power plug immediately and contact your nearest service center.

- Failing to do so may result in electric shock or fire

In the event of a gas leak (such as propane gas, LP gas, etc.), ventilate immediately without touching the power cord. Do not touch the appliance.

- A spark may result in an explosion or fire.

Take care that the door, heater or any of the other parts do not come into contact with the body while cooking or just after cooking.

- Failing to do so may result in burns.

If materials inside oven should ignite, keep the oven door closed, turn the oven off and disconnect the power cord, or shut off power at the fuse or circuit breaker panel. If the door is opened, the fire may spread.

Always observe Safety Precautions when using your oven. Never try to repair the oven on your own - there is dangerous voltage inside. If the oven needs to be repaired, contact an authorized service center near you.

Use the appliance only after closing the door.

If you use the appliance when it is contaminated by alien substances such as food waste, it may result in a problem with the appliance.

Take care when removing the wrapping when taking food out of the appliance.

- If the food is hot, hot steam may be emitted abruptly when removing the wrapping and this may result in burns.

- Do not attempt to repair, disassemble, or modify the appliance yourself.
  - Since a high voltage current enters the product chassis, it may result in electric shock or fire.
  - When repairing the appliance is required, contact your nearest service center.

- If any foreign substance such as water has entered the appliance, contact your nearest service center.
  - Failing to do so may result in electric shock or fire.

- Do not touch the power cord with wet hands.
  - This may result in electric shock.

Do not turn the appliance off while an operation is in progress.

- This may cause a spark and result in electric shock or fire.

Keep all packaging materials well out of the reach of children, as packaging materials can be dangerous to children.

- If a child places a bag over its head, it may result in suffocation.

- ☐ Do not let children or any person with reduced physical, sensory or mental capabilities use this appliance unsupervised.

Make sure that the appliance is out of the reach of children.

- Failing to do so may result in electric shock, burns or injury.

Do not touch the inside of the appliance immediately after cooking, because the inside of the appliance is hot after being heated for a long time or heating a small amount of food.

- Failing to do so may result in burns.

Do not use or place inflammable sprays or objects near the oven.

- This may result in fire or an explosion.

Do not insert fingers, foreign substances or metal objects such as pins or needles into the inlet, outlet, and holes. If foreign substances are inserted into any of these holes, contact your product provider or nearest service center.

Do not tamper with or make any adjustments or repairs to the door. Under no circumstances should you remove the outer cabinet.

Do not store or use oven outdoors.

Never use this appliance for purposes other than cooking.

- This may result in fire.

Open the cap or stopper of a sealed container (herb tonic tea bottle, baby bottle, milk bottle and so on) and make a hole in food items such as shells or nuts (eggs, chestnuts, etc) with a knife, before cooking them.

- Failing to do so may result in burns or injury.

Never heat plastic or paper containers and do not use them.

- Failing to do so may result in fire.

Do not heat food wrapped in paper such as magazines and newspaper.

- This may result in fire.

Do not open the door when the food in the cooking compartment is burning.

- If you open the door, it causes an inflow of oxygen and this may result in fire.

Do not apply excessive pressure or impact to the door or the inside of the appliance.

- Hanging on to the door may result in the product falling and causing injury.
- If the door is damaged, do not use the appliance and contact a service center.

Do not hold food or any part there of during or immediately after cooking.

- Use cooking gloves because it may be very hot and you could burn yourself.



## CAUTION SIGNS FOR USING

---

-  When the surface is cracked, turn the power switch of the appliance off.
- Failing to do so may result in electric shock.

Dishes and containers can become hot. Handle with care.

Hot foods and steam can cause burns. Carefully remove container coverings, directing steam away from hands and face.

Remove lids from baby food before heating. After heating baby food, stir well to distribute the heat evenly. Always test temperature by tasting before feeding the baby. The glass jar or surface of the food may appear to be cooler than the interior, which can be so hot as to burn the infant's mouth.

Make sure all cookware used in the oven.

Take care as beverages or food may be very hot after heating.

- Especially when feeding a child, check that it has cooled sufficiently.

Take care when heating liquids such as water or other beverages.

- Make sure to stir during or after cooking.
- Avoid using a slippery container with a narrow neck.
- Remove the container at least 30 seconds after heating.
- Failing to do so may result in an abrupt overflow of the contents and cause burns.

 Do not stand on top of the appliance or place objects (such as laundry, oven cover, lighted candles, lighted cigarettes, dishes, chemicals, metal objects, etc.) on the appliance.

- Items, such as a cloth, may be caught in the door.
- This may result in electric shock, fire, problems with the product, or injury.

Do not operate the appliance with wet hands.

- This may result in electric shock.

Do not spray volatile material such as insecticide onto the surface of the appliance.

- As well as being harmful to humans, it may also result in electric shock, fire or problems with the product.

Do not put your face or body close to the appliance while cooking or when opening the door just after cooking.

- Take care that children do not come too close to the appliance.
- Failing to do so may result in children burning themselves.

Do not place food or heavy objects over the door when opening the door.

- The food or object may fall and this may result in burns or injury.

Do not abruptly cool the door, the inside of the appliance, or the dish by pouring water over it during or just after cooking.

- This may result in damage to the appliance. The steam or water spray may result in burns or injury.

Do not operate while empty except for self-cleaning.

Do not cook without the glass tray in place on the oven floor. Food will not cook properly without the tray.

Do not defrost frozen beverages in narrow-necked bottles. The containers can break.

Do not scratch the glass of the oven door with a sharp object.

- This may result in the glass being damaged or broken.

Do not store anything directly on top of the appliance when it is in operation.

Do not use sealed containers. Remove seals and lids before use. Sealed containers can explode due to buildup of pressure even after oven has been turned off.

Take care that food does not come into contact with the heater when cooking food with the oven.

- This may result in fire.

Do not over-heat food.

- Failing to do so may result in fire.



## SEVERE WARNING SIGNS FOR CLEANING

- ★ Do not clean the appliance by spraying water directly on to it.

Do not use benzene, thinner or alcohol to clean the appliance.

- This may result in discoloration, deformation, damage, electric shock or fire.

Take care not to hurt yourself when cleaning the appliance (external/internal).

- You may hurt yourself on the sharp edges of the appliance.

Do not clean the appliance with a steam cleaner.

- This may result in corrosion.

Keep the inside of the oven clean. Food particles or spattered oils stuck to the oven walls or floor can cause paint damage and reduce the efficiency of the oven.



## APPLIANCE OUTLETS

- ★ The 120V appliance outlets located on the control console may be used to run portable appliances placed on countertops beside the range.

The outlets operate independently and are not affected by range control settings.

- ☐ Do not place portable appliances on the cooktop. Damage to the portable appliance could result if the cooktop is hot.

- ☐ **Appliance outlet circuit breakers:** The circuit breakers for the appliance outlets on your range are located on top of the control console. They are rated for 15 amps, that may trip if the appliance plugged into it exceeds 15 amps. To reset the circuit breaker, press the switch of located on the control console.

- ★ If appliance outlet don't operate, test out your small portable appliance by plugging into other outlets.

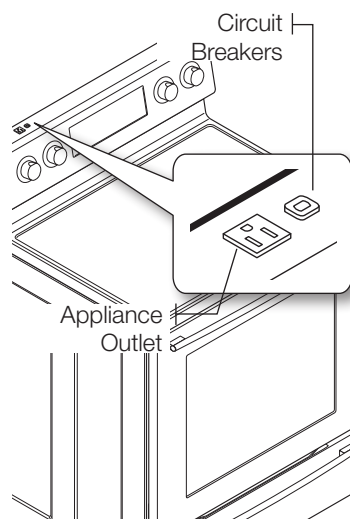

# contents

---

## **INTRODUCING YOUR NEW RANGE**

17

- 17 Overview
- 17 What's included with your range

## **SURFACE COOKING**

18

- 18 About surface cooking
- 20 How to set the appliance for surface cooking
- 23 Using the proper cookware
- 23 Choosing the proper cookware
- 24 Protecting the smoothtop surface

## **USING THE WARMING DRAWER**

25

- 25 About the warming drawer
- 26 Turning the warming drawer on or off

## **OPERATING THE OVEN**

27

- 27 The oven control panel
- 28 Setting the clock
- 29 Minimum and maximum settings
- 29 Setting the kitchen timer
- 30 Using the oven racks
- 31 Baking
- 32 Convection baking
- 34 Convection roasting
- 36 Timed cooking
- 37 Delay timed cooking
- 38 Broiling
- 40 Using the custom cook feature
- 41 Proofing
- 42 Using the keep warm function
- 43 Extra features
- 45 Turning the oven light on and off

## **MAINTAINING YOUR APPLIANCE**

47

- 47 Self-cleaning
- 49 Steam-cleaning
- 50 Care and cleaning of the oven
- 52 Care and cleaning of the glass cooktop
- 54 Removing and replacing the oven door
- 55 Removing and replacing the warming drawer
- 56 Changing the oven light

## **TROUBLESHOOTING**

57

- 57 Troubleshooting

## **WARRANTY**

61



# introducing your new range

## OVERVIEW

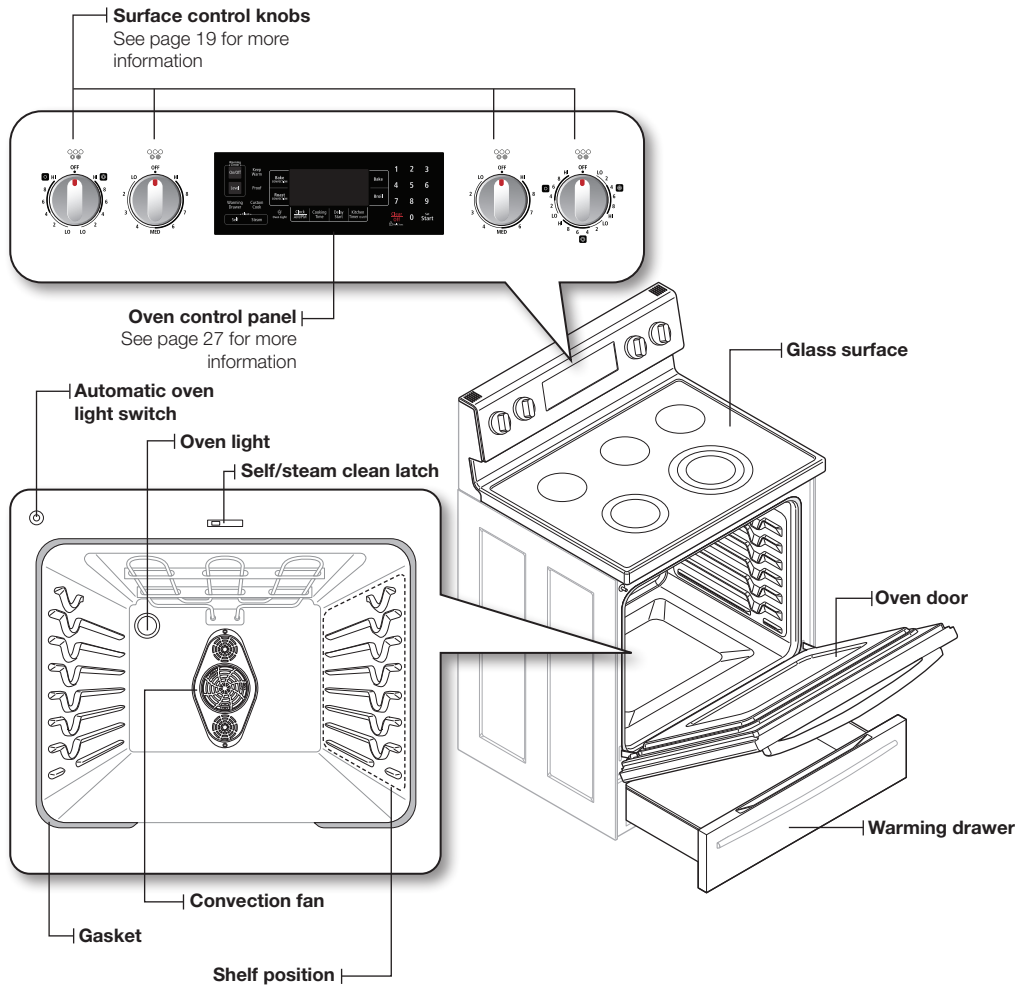

## WHAT'S INCLUDED WITH YOUR RANGE

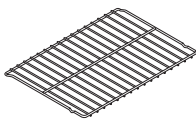

Wire racks

DG75-01001A

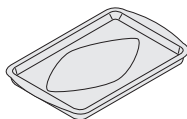

Broil pan

DG63-00067A

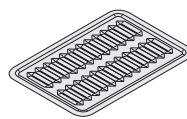

Broil pan insert

DG63-00068A



Cleaner & cleaning pad

DG97-00085A

# surface cooking

---

## ABOUT SURFACE COOKING

---



### BEFORE COOKING

- Do not use the glass cooktop surface as a cutting board.
- Do not place or store items that can melt or catch fire on the glass cooktop, even when it is not being used.
- Turn the surface units on only after placing the cookware on them.
- Do not store heavy items above the cooktop surface. They could fall and damage it.



### DURING COOKING

- Do not place aluminum foil or plastic items such as salt and pepper shakers, spoon holders, or plastic wrappings on the range when it is in use. The hot air from the vent could melt plastics or ignite flammable items.
- Make sure the correct surface unit is turned on.
- Never cook directly on the glass. Always use cookware.
- Always place the pan in the center of the surface unit you are cooking on.
- Never leave surface units unattended while using a high heat setting. Boilovers cause smoking and/or greasy spllovers spillovers that may catch on fire.
- Turn the surface units off before removing cookware.
- Do not use plastic wrap to cover food. Plastic may melt onto the surface and be very difficult to remove.



### AFTER COOKING

- Do not touch the surface units until they have cooled down.
- The surface may be still be hot and burns may occur if the glass surface is touched before it has cooled down sufficiently.
- Immediately clean spills on the cooking area to prevent a tough cleaning chore later.
- If cabinet storage is provided directly above the cooking surface, make sure that the items are infrequently used and can be safely stored in an area subjected to heat. Temperatures may be unsafe for items such as volatile liquids, cleaners or aerosol sprays.

## About the radiant surface elements

---

The temperature rises gradually and evenly. As the temperature rises, the radiant element will glow red. To maintain the selected setting, the element will cycle on and off. The heating element retains enough heat to provide a uniform and consistent heat during the off cycle. For efficient cooking, turn off the element several minutes before cooking is complete. This will allow residual heat to complete the cooking process.



Radiant elements have a limiter that allows the element to cycle ON and OFF, even at the HI setting. This helps to prevent damage to the ceramic cooktop. Cycling at the HI setting is normal and can occur if the cookware is too small for the radiant element or if the cookware bottom is not flat.

## Location of the radiant surface elements and controls

The radiant control knobs operate the radiant surface elements on the cooktop as shown below.

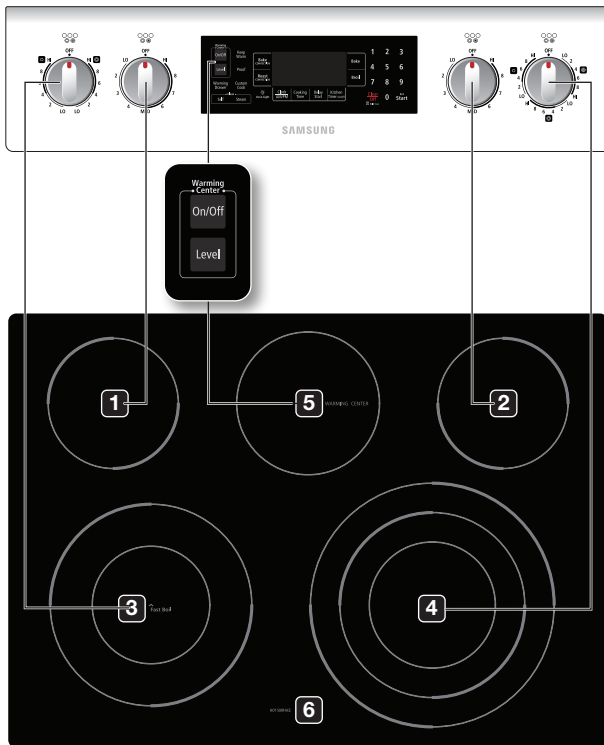

1. **Single element:** Left rear
2. **Single element:** Right rear
3. **Dual element:** Left front
4. **Triple element:** Right front
5. **Warming center:** Center rear
6. **Hot surface indicator**

## Hot surface indicator

**HOT SURFACE**

- Comes on when the unit is turned on or hot to the touch.
- Stays on even after the unit is turned off.
- Glows until the unit is cooled to approximately 150°F.

## Cooking areas

- The cooking areas on your range are identified by permanent circles on the glass cooking surface. For the most efficient cooking, fit the pan size to the element size.
- **Pans should not extend more than ½” to 1” beyond the cooking area.**
- When a control is turned on, a glow can be seen through the glass cooking surface. **The element will cycle on and off to maintain the preset heat setting, even at high settings.**
- For more information on selecting proper types of cookware, refer to the section “Using the proper cookware” on page 23.

## HOW TO SET THE APPLIANCE FOR SURFACE COOKING



- The surface elements may be hot and burns may occur. Do not touch the surface elements until they have cooled down sufficiently.
- At high or medium-high settings, never leave food unattended. Boilovers cause smoking and greasy spillovers may catch on fire.
- Be sure you turn the control knob to **OFF** when you finish cooking.

### Single surface unit control knob (left rear, right rear)

1. Push the knob in.
  2. Turn in either direction to the setting you want.
- At both the off and high settings, the knob clicks into position.

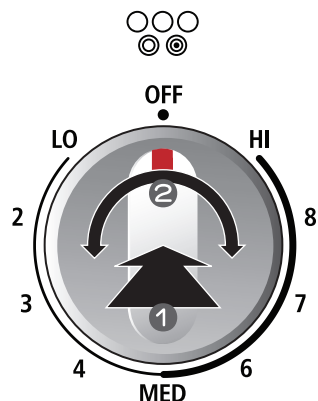

### Dual surface unit control knob (left front)

The dual surface unit has 2 cooking sizes to select from so you can match the size of the unit to the size of the cookware you are using.

1. Push the knob in.
  2. Turn in either direction to the setting you want.
- To use the small surface unit, turn the control knob to the **small burner (A)** settings.
  - To use the large surface unit, turn the control knob to the **large burner (B)** settings.

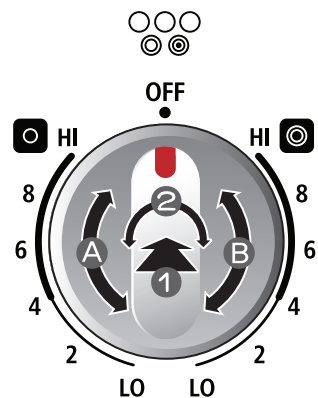

The area between the high and off settings is not appropriate for cooking.

## Triple surface unit control knob (right front)

The dual surface unit has 3 cooking sizes to select from so you can match the size of the unit to the size of the cookware you are using.

1. Push the knob in.
2. Turn in either direction to the setting you want.
  - To use the small surface unit, turn the control knob to the **small burner (A)** settings.
  - To use the middle surface unit, turn the control knob to the **middle burner (B)** settings.
  - To use the large surface unit, turn the control knob to the **large burner (C)** settings.

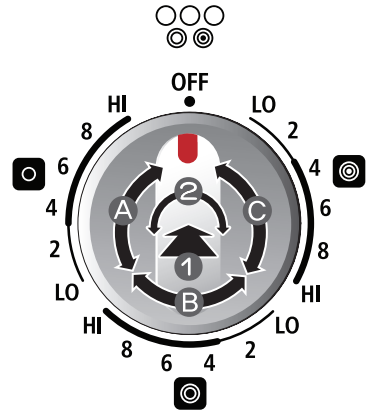

The area between the high and off settings is not appropriate for cooking.



When changing from a high heat setting to a lower heat setting, the surface unit may stop glowing. This is normal.

## Recommended settings

SETTING	TYPE OF COOKING
<b>HIGH</b>	Starting most foods, bringing water to a boil, pan broiling
<b>MEDIUM HIGH</b>	Continuing a rapid boil, frying, deep fat frying
<b>MEDIUM</b>	Maintaining a slow boil, thickening sauces and gravies, steaming vegetables
<b>MEDIUM LOW</b>	Keeping foods cooking, poaching, stewing
<b>LOW</b>	Keeping warm, melting, simmering

## Using the warming center

The **warming center**, located in the back center of the glass surface, will keep hot, cooked food at serving temperature.



- **The surface warmer will not glow red like the cooking elements.**



- Do not warm food on the warming center for more than two hours.
- Use only cookware and dishes recommended as safe for oven and cooktop use.
- Always use potholders or oven mitts when removing food from the warming center as cookware and plates will be hot.
- When warming pastries and breads, the cover should have an opening to allow moisture to escape.
- Do not use plastic wrap to cover foods. Plastic may melt onto the surface and be very difficult to clean.
- Food should be kept in its container and covered with a lid or aluminum foil to maintain food quality.
- Always start with hot food. Eating uncooked or cold food placed on the warming center could result in illness.

1. Turn the warming center on.

Press the **WARMING CENTER ON/OFF** pad.

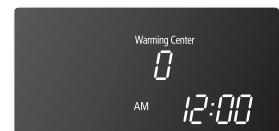

2. Select the power setting you want.

Pressing the **WARMING CENTER LEVEL** pad once will set it to the level 1 setting. Press the pad twice for the level 2 setting, 3 times for level 3.

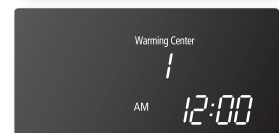

3. Turn the warming center off.

Press the **WARMING CENTER ON/OFF** pad.



- Pressing the **CLEAR/OFF** pad does not turn the warming center off.
- For best results, all foods on the warming center should be covered with a lid or aluminum foil. When warming pastries or breads, the cover should be vented to allow moisture to escape.

## Recommended settings



LEVEL	TYPE OF FOOD
1	Breads/pastries, casseroles, gravies, eggs
2	Dinner plate with food, soups (cream), vegetables, sauces, stews, meats
3	Fried foods, soups (liquid), hot beverages

## USING THE PROPER COOKWARE

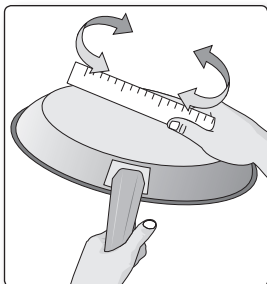
Using the right cookware can prevent many problems, such as uneven cooking or extended cooking times. Using the proper pans will reduce cooking times and cook food more evenly.

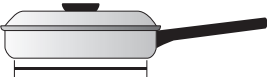
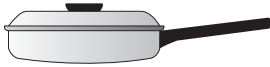
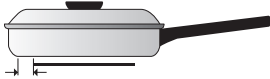

Check for flatness by rotating a ruler across the bottom of the cookware.

CORRECT	INCORRECT
 <p>Flat bottom and straight sides.</p> <ul style="list-style-type: none"> <li>• Tight fitting lids.</li> <li>• Weight of handle does not tilt pan.</li> <li>• Pan is well balanced.</li> <li>• Pan size matches the amount of food to be prepared and the size of the surface element.</li> <li>• Made of a material that conducts heat well.</li> <li>• Always match pot diameter to element surface diameter.</li> </ul>	 <p>Curved and warped pan bottoms.</p>  <p>Pan overhangs element by more than one-half inch.</p>  <p>Pan is smaller than element.</p>  <p>Heavy handle tilts pan.</p>

## CHOOSING THE PROPER COOKWARE

What your cookware is made of determines how evenly and quickly heat is transferred from the surface element to the pan bottom.

- **ALUMINUM** - Excellent heat conductor. Some types of food will cause the aluminum to darken. (Anodized aluminum cookware resists staining & pitting.) If aluminum pans are slid across the ceramic cooktop, they may leave metal marks that resemble scratches. Remove these marks as soon as the cooktop cools down.
- **COPPER** - Excellent heat conductor but discolors easily. May leave metal marks on ceramic glass (see above).
- **STAINLESS STEEL** - Slow heat conductor with uneven cooking results. Is durable, easy to clean and resists staining.
- **CAST IRON** - A poor conductor; retains heat very well. Cooks evenly once cooking temperature is reached. Not recommended for use on ceramic cooktops.
- **ENAMELWARE** - Heating characteristics will vary depending on base material. Porcelain-enamel coating must be smooth to avoid scratching ceramic cooktops.
- **GLASS** - Slow heat conductor. Not recommended for ceramic cooktop surfaces because it may scratch the glass.

## PROTECTING THE SMOOTHTOP SURFACE

---

### Cleaning

---

- Clean the cooktop before using it for the first time.
- Clean your cooktop daily or after each use. This will keep your cooktop looking good and can prevent damage.
- If a spillover occurs while cooking, immediately clean the spill from the cooking area while it is hot to prevent a tough cleaning chore later. Using extreme care, wipe the spill with a clean dry towel.
- Do not allow spills to remain on the cooking area or the cooktop trim for a long period of time.
- **Do not** use abrasive cleansing powders or scouring pads, which will scratch the cooktop.
- **Do not** use chlorine bleach, ammonia, or other cleansers not specifically recommended for use on a glass-ceramic surface.

### Preventing marks and scratches

---

- Do not use glass cookware. It may scratch the cooktop.
- **Do not** place a trivet or wok ring between the cooktop and the pan. These items can mark or scratch the cooktop.
- Make sure the cooktop and the pan bottom are clean.
- **Do not** slide metal pans across the cooktop.

### Preventing stains

---

- **Do not** use a soiled dish cloth or sponge to clean the cooktop surface. A film will remain, which may cause stains on the cooking surface after the area is heated.
- Continuously cooking on a soiled surface may/will result in a permanent stain.

### Preventing other damage

---

- Do not allow plastic, sugar, or foods with high sugar content to melt onto the hot cooktop. Should this happen, clean immediately.
- Do not let a pan boil dry as this will damage the cooktop. and the pan.
- **Do not** use the cooktop as a work surface or cutting board.
- **Do not** cook food directly on the cooktop without the proper cookware.



# using the warming drawer

## ABOUT THE WARMING DRAWER

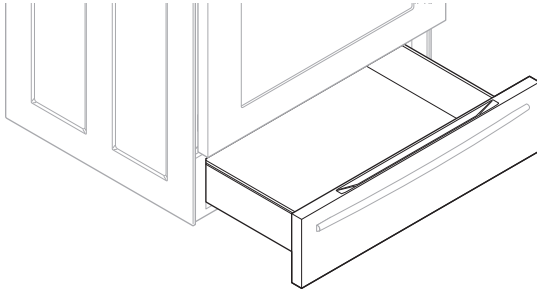

The **warming drawer** will keep hot, cooked foods warm. Always start with hot food. Do not use to warm cold food other than bread, crisping crackers, chips or dry cereal.

Allow approximately 25 minutes for the warming drawer to preheat.

- **Do not line the warming drawer or pan with aluminum foil. Foil is an excellent heat insulator and will trap heat beneath it. This will upset the performance of the drawer and could damage the interior finish.**
- Do not put liquid or water in the warming drawer.
- All foods placed in the warming drawer should be covered with a lid or aluminum foil. When warming pastries or breads, the cover should be vented to allow moisture to escape.
- Remove serving spoons, etc., before placing containers in the warming drawer.
- Food should be kept hot in its cooking container or transferred to a heat-safe serving dish.



Plastic containers or plastic wrap will melt if in direct contact with the drawer, pan or a hot utensil. Melted plastic may not be removable and is not covered under your warranty.

## TURNING THE WARMING DRAWER ON OR OFF

1. Set the warming drawer to the heat level you want.

Press the **WARMING DRAWER** pad once for low, twice for medium, or 3 times for high or 4 times for off.

The warming drawer starts automatically once you have finished selecting the level you want.



2. To turn the warming drawer off, press the **WARMING DRAWER** pad until the warming drawer turns off.

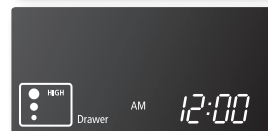

- Pressing the **CLEAR/OFF** pad does not turn the warming drawer off.
- The warming drawer cannot be used during a self-cleaning cycle.

### Recommended settings

LEVELS		TYPE OF FOOD
	<b>Low</b>	Rolls (soft), empty dinner plates
	<b>Medium</b>	Gravies, eggs, biscuits, pastries, casseroles, vegetables, rolls (hard), roasts (beef, pork, lamb)
	<b>High</b>	Bacon, poultry, pizza, hamburger patties, pork chops, fried foods

- Different types of food may be placed in the warming drawer at the same time. For best results, do not leave foods in the warming drawer for longer than 1 hour. Do not leave smaller quantities or heat-sensitive foods, such as eggs, for longer than 30 minutes.
- The warming drawer will shut off automatically after 3 hours.

# operating the oven

## THE OVEN CONTROL PANEL

**READ THE INSTRUCTIONS CAREFULLY BEFORE USING THE OVEN.** For satisfactory use of your oven, become familiar with the various features and functions of the oven as described below. **Detailed instructions for each feature and function follow later in this user manual.**

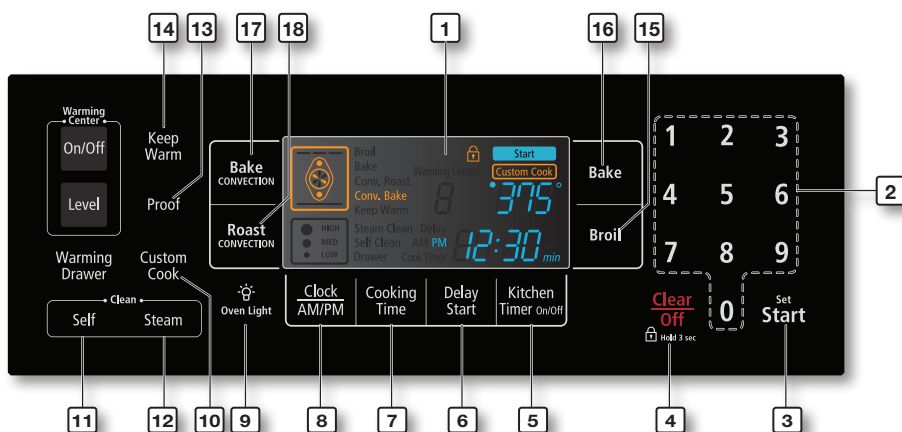

- 1. DISPLAY:** Shows the time of day, oven temperature, whether the oven is in the bake, broil or self-cleaning mode, and the times set for the timer or automatic oven operations.
- 2. NUMBER PADS:** Use to set any function requiring numbers such as the time of day on the clock, the timer, the oven temperature, the start time and length of operation for timed baking.
- 3. SET/START:** Must be pressed to start any cooking or cleaning function.
- 4. CLEAR/OFF:** Press to cancel all oven operations except the clock and timer, warming center, and warming drawer.
- 5. KITCHEN TIMER ON/OFF:** Press to select the timer feature.
- 6. DELAY START:** Use along with Bake, Conv. Bake, Conv. Roast, Cooking Time, and Self Clean pads to set the oven to start and stop automatically at a time you set.
- 7. COOKING TIME:** Press and then use the number pads to set the amount of time you want your food to cook. The oven will shut off when the cooking time has run out.
- 8. CLOCK AM/PM:** Press to set the time of day.
- 9. OVEN LIGHT:** Press to turn the oven light on or off.
- 10. CUSTOM COOK:** Press to record and recall your favorite recipe setting.
- 11. SELF CLEAN:** Press to select the self-cleaning function.
- 12. STEAM CLEAN:** Press to select the steam-cleaning function.
- 13. PROOF:** Press to select a warm environment useful for rising yeast-leavened products.
- 14. KEEP WARM:** Press to keep cooked foods warm.
- 15. BROIL:** Press to select the broil function.
- 16. BAKE:** Press to select the bake function.
- 17. CONVECTION BAKE:** Press to select baking with the convection function.
- 18. CONVECTION ROAST:** Press to select roasting with the convection function.

## SETTING THE CLOCK

---

The **clock** must be set to the correct time of day for the automatic oven timing functions to work properly.

- The time of day cannot be changed during a timed cooking, a delay-timed cooking or a self-cleaning cycle.
- You can choose between a 12-hour or 24-hour display. The default is 12-hour.

### How to set the clock

---

1. Start the setup.

Press the **CLOCK AM/PM** pad.

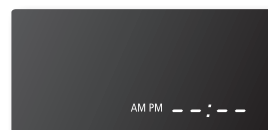

2. Select AM or PM.

Press the **CLOCK AM/PM** pad again, once to select AM or twice to select PM.

This step is skipped in the 24-hour display mode.



3. Enter the present time.

Enter the current time in hours and minutes on the number pad, eg. 1, 3, 0, for 1:30.



4. Exit the set up.

Press the **SET/START** or **CLOCK AM/PM** pad.

### How to change between a 12-hour and 24-hour display

---

1. Start the setup.

Press **CLOCK AM/PM** and **0** on the number pad at the same time for 3 seconds.

The display will show the present mode (eg. 12 hour).



2. Select the display mode you want.

Press **0** on the number pad to select 12 hour or 24 hour.

Pressing **0** on the number pad changes the display between 12 hour and 24 hour.

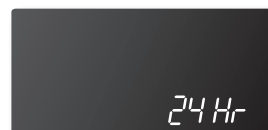

3. Exit the set up.











Press the **SET/START** pad.



## MINIMUM AND MAXIMUM SETTINGS

All of the features listed have minimum and maximum time or temperature settings.

A beep will sound each time a pad on the control panel is pressed and the entry is accepted. An error tone will sound in the form of a long beep if the entered temperature or time is below the minimum or above the maximum setting for the feature.

FEATURE	MINIMUM	MAXIMUM
 Bake	150°F (65°C)	550°F (285°C)
 Broil	LO	HI
 Self Clean	2 Hr.	4 Hr.
 Convection Bake	175°F (80°C)	550°F (285°C)
 Convection Roast	175°F (80°C)	550°F (285°C)
 Keep Warm	-	3 Hr.
 Warming Center	-	3 Hr.
 Warming Drawer	-	3 Hr.
 Proof	-	12 Hr.
 Steam Clean	20 Min.	20 Min.

## SETTING THE KITCHEN TIMER

The kitchen timer serves as an extra timer that will beep when the set time has elapsed. It does not start or stop cooking functions. The feature can be used during any of the other oven functions.

### How to set the timer

1. Turn the timer on.

Press the **KITCHEN TIMER ON/OFF** pad.

2. Select the unit of time you want.

Press the **KITCHEN TIMER ON/OFF** pad once to select hours/minutes, twice to select seconds or three times to turn the kitchen timer off.



3. Enter the amount of time you want.

Enter the amount of time you want using the number pad, eg. 1, 5. The timer can be set for any amount of time from 1 minute to 9 hours and 99 minutes or 1 second to 99 minutes and 99 seconds. If you make a mistake, press the **KITCHEN TIMER ON/OFF** pad and start again.

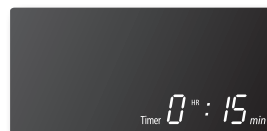

4. Start the timer.

Press the **KITCHEN TIMER ON/OFF** pad.

5. When the set time has elapsed, the oven will beep and the display will show End until you press the **KITCHEN TIMER ON/OFF** pad. You can cancel the timer at any time by pressing the **KITCHEN TIMER ON/OFF** pad.

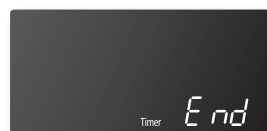

# USING THE OVEN RACKS

## Oven rack positions

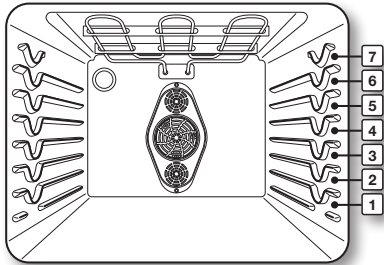

The oven has 7 rack positions (1~7).

TYPE OF FOOD	RACK POSITION
Frozen pies	4
Angel food cake	2
Bundt or pound cakes	3
Biscuits, muffins, brownies, cookies, cupcakes, layer cakes, pies	4
Casseroles	4
Small roast, ham	2
Turkey, large roast	1

## Baking layer cakes

Centering the baking pans in the oven as much as possible will produce better results. If baking with more than one pan, place the pans so each has at least 1" to 1½" of air space around it.

If baking four cake layers at the same time, place the oven racks in positions 2 and 5. Place two pans in the front of the top rack and the other two pans in the rear of the bottom rack.

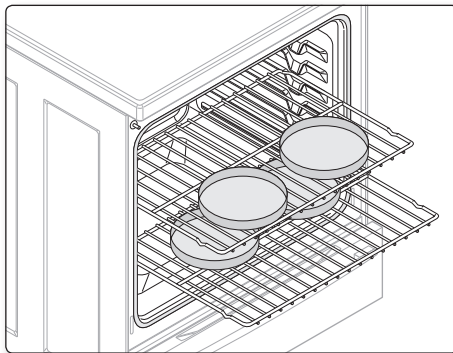

Fig. 1

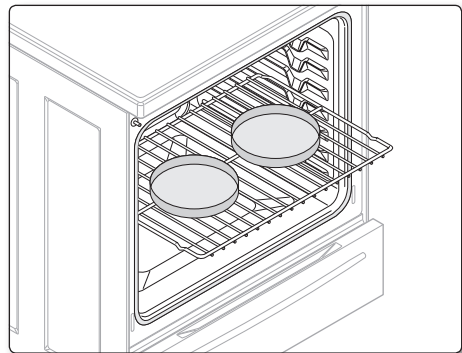

Fig. 2

## Before using the racks

The oven has three racks.

Each rack has stops that need to be placed correctly on the supports. These stops will keep the rack from coming completely out.

REMOVING THE RACKS	REPLACING THE RACKS
1. Pull the rack straight out until it stops.	1. Place the end of the rack on the support.
2. Lift up the front of the rack and pull it out.	2. Tilt the front end up and push the rack in.



- Do not cover a rack with aluminum foil or place on the oven bottom. This will disturb the heat circulation, resulting in poor baking, and may damage the oven bottom.
- Arrange the oven racks only when the oven is cool.

## BAKING

The oven can be programmed to bake at any temperature from 150°F to 550°F.

### How to set the thermostat

1. Start the set up.

Press the **BAKE** pad. The default temperature is 350°F.

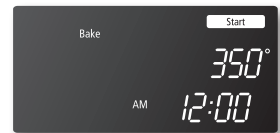

2. Enter the temperature you want on the number pad, eg. 3, 7, 5.

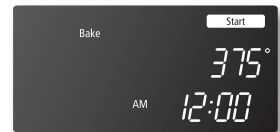

3. Start the bake function.

Press the **SET/START** pad. The temperature display will start to change once the oven temperature reaches 150°F.

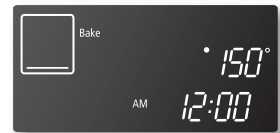

4. If you want to cancel baking or if you have finished, press the **CLEAR/OFF** pad.



Place food in the oven after preheating if the recipe calls for it. Preheating is very important for good results when baking cakes, cookies, pastry, and breads. After the oven has reached the desired temperature, a long beep will sound 6 times.

### How to adjust the thermostat while cooking

1. Start the setup.

Press the **BAKE** pad. The display will show the present temperature, eg. 375°F.



2. Enter the temperature you want, eg. 425°F, by using the number pad.

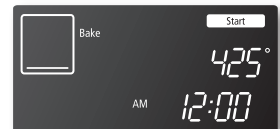

3. Complete the entry by pressing the **SET/START** pad.

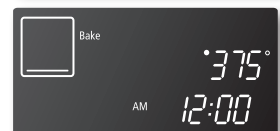

## CONVECTION BAKING

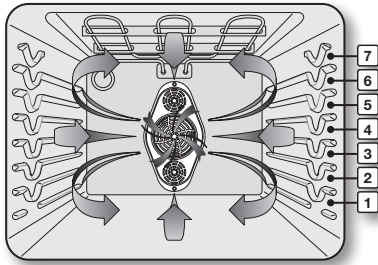

By using the convection bake feature, you will be able to cook faster. You can program the oven for convection baking at any temperature between 175°F and 550°F.

Convection baking uses a fan to circulate the oven's heat evenly and continuously within the oven. This improved heat distribution allows for even cooking and excellent results using multiple racks at the same time. Foods cooked on a single oven rack will generally cook faster and more evenly with convection baking. Multiple oven

rack cooking may slightly increase cook times for some foods, but the overall result is time saved. Breads and pastries brown more evenly.

### Tips for convection baking

The amount of time you save will vary depending on the amount and type of food you are cooking. When baking cookies or biscuits, you should use pans with no sides or very low sides to allow the heated air to circulate around the food. Using a pan with a dark finish will allow faster cooking times.

When using convection baking with a single rack, place the oven rack in **position 4**. If cooking on multiple racks, place the oven racks in **positions 2 and 5** or **positions 2, 4 and 6**.

When baking a cake, using the bake mode will produce better results.

### How to set the oven for convection baking

1. Start the convection baking mode.

Press the **CONV. BAKE** pad. The default temperature is 350°F.

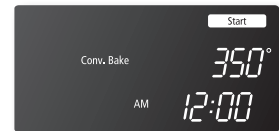

2. Enter the temperature you want, eg. 400°F, by using the number pads.

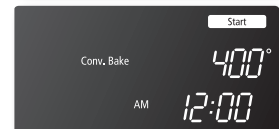

3. Press the **SET/START** pad to begin convection baking.

Conv. Bake and the adjusted oven temperature, eg. 375°F, will appear in the display for 2 seconds.

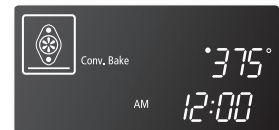

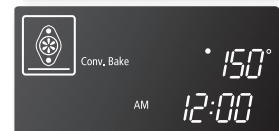

The temperature display will start to change once the oven temperature reaches 150°F.

A beep will sound 6 times when the adjusted oven temperature, eg. 375°F, is reached and the display will show the auto-converted oven temperature.



4. Turn off or cancel convection baking by pressing the **CLEAR/OFF** pad.

 In convection baking mode, the oven automatically reduces the set regular baking temperature by 25°F to the appropriate conversion temperature.

 The convection oven fan shuts off when the oven door is opened. DO NOT leave the door open for long periods of time while using convection cooking or you may shorten the life of the convection heating element.



## Recommended convection baking guide

Food Item	Rack Position	Temp.* (preheated oven) ( °F )	Convection bake time ** (min)
<b>Cake</b>			
Cupcakes	4	325	17-19
Bundt Cake	3	325	35-43
Angel Food	2	325	35-39
<b>Pie</b>			
2 crust, fresh, 9"	3	350-400	45-55
2 crust, frozen fruit, 9"	3	350	68-78
<b>Cookies</b>			
Sugar	4	325-350	12-17
Chocolate Chip	4	325-350	14-18
Brownies	4	325	29-36
<b>Breads</b>			
Yeast bread, loaf, 9x5	3	350	18-22
Yeast rolls	4	350-375	13-18
Quick Bread, loaf, 8x4	3	325-350	45-55
Biscuits	4	350-375	9-14
Muffins	4	400	15-19
<b>Pizza</b>			
Frozen	4	375-425	23-26
Fresh	4	400-425	12-15



\* The convection bake temperature is 25°F less than recommended on packages or recipes. The temperature in this chart has been reduced 25°F.

\*\* Actual times depend on the mixes or recipes baked. Follow recipe or package directions and reduce temperature appropriately.

## CONVECTION ROASTING

Convection roasting is good for cooking large tender cuts of meat, uncovered.

Heat comes from the top heating element. The convection fan circulates the heated air evenly over and around the food. Meat and poultry are browned on all sides as if they were cooked on a rotisserie. The heated air seals in juices quickly for a moist and tender product while, at the same time, creating a rich golden brown exterior.

### How to set the oven for convection roasting

1. Start the convection roasting mode.

Press the **CONV. ROAST** pad. The default temperature is 350°F.

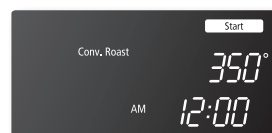

2. Enter the temperature you want, eg. 400°F, by using the number pads.

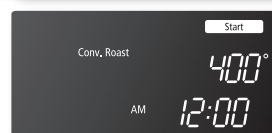

3. Press the **SET/START** pad to begin convection roasting.

Conv. Roast and the adjusted oven temperature, eg. 375°F, will appear in the display for 2 seconds.

The temperature display will start to change once the oven temperature reaches 150°F.

A beep will sound 6 times when the adjusted oven temperature, eg. 375°F, is reached and the display will show the auto-converted oven temperature.

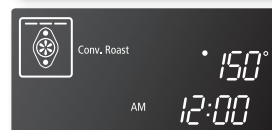
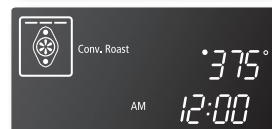

4. Turn off or cancel convection roasting by pressing the **CLEAR/OFF** pad.



In the convection roasting mode, the oven will automatically reduce the set regular baking temperature by 25°F to the appropriate conversion temperature.



The convection oven fan shuts off when the oven door is opened. DO NOT leave the door open for long periods of time while using convection cooking or you may shorten the life of the convection heating element.

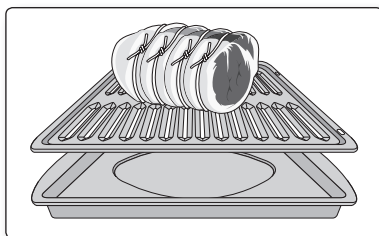

When you use the convection roasting feature, it is important that you use the broil pan and insert. The pan is used to catch grease spills and the grid is used to prevent grease splatters.

## Recommended convection roasting guide

Meat	Weight (lb)	Oven temp. ( °F )	Roasting time* (min per lb)	Internal temp. ( °F )
<b>Beef</b>				
Rib Roast	4-6	325	25-28 28-32	145 (med/rare) 160 (medium)
Rib Eye Roast, (boneless)	4-6	325	24-29 29-34	145 (med/rare) 160 (medium)
Rump, Eye, Tip Sirloin (boneless)	3-6	325	25-30 28-35	145 (med/rare) 160 (medium)
Tenderloin Roast	2-3	325	28-38	145 (med/rare)
<b>Pork</b>				
Loin Roast (boneless or bone-in)	5-8	350	15-25	170
Shoulder	3-6	350	20-30	160
<b>Poultry</b>				
Chicken - whole	3-4	375	17-23	180
Turkey, unstuffed**	12-15	325	12-16	180
Turkey, unstuffed**	16-20	325	11-15	180
Turkey, unstuffed**	21-25	325	8-12	180
Turkey Breast	3-8	325	20-25	170
Cornish Hen	1-1½	350	45-75 (total time)	180
<b>Lamb</b>				
Half Leg	3-4	325	25-30 30-35	160 (medium) 170 (well)
Whole Leg	6-8	325	25-30 30-35	160 (medium) 170 (well)



\* Roasting times are approximate and may vary depending on the shape of the meat. The convection roast temperature is 25°F less than recommended on packages or recipes. The temperature in this chart has been reduced 25°F.

\*\* Stuffed turkey requires additional roasting time. The minimum safe temperature for stuffing in poultry is 165°F.

## TIMED COOKING

In timed cooking, the oven turns on immediately and cooks for the length of time you select. At the end of the cooking time, the oven turns off automatically.

- You can use the timed cooking feature only with another cooking operation (bake, convection bake, or convection roast).
- You can set the oven for timed cooking before setting other cooking operations.
- The clock must be set to the current time.

### How to set the oven for timed cooking

1. Enter the setup.

Press the pad for the cooking operation you want, eg. BAKE. The default temperature is 350°F.

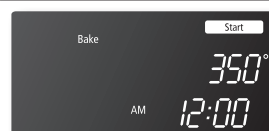

2. Enter the temperature you want, eg. 375°F, by using the number pads.

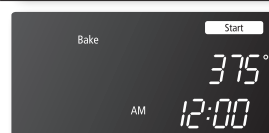

3. Press the **COOKING TIME** pad.

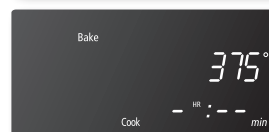

4. Enter the cooking time you want, eg. 45 min, by using the number pads.

You can set the cooking time for any amount from 1 minute to 9 hours and 99 minutes.

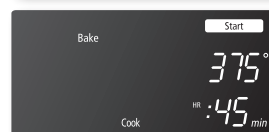

5. Press the **SET/START** pad to begin cooking operation.

The temperature display will start to change once the oven temperature reaches 150°F.

The oven will continue to cook until the set amount of time has elapsed, then turn off automatically unless the keep warm feature was set. (Refer to the section on the keep warm feature on page 42.)



6. You can cancel a timed cooking at any time by pressing the **CLEAR/OFF** pad.



Place food in the oven after preheating if the recipe calls for it. Preheating is important for good results when baking cakes, cookies, pastry, and breads. After the oven has reached the desired temperature, a long beep will sound 6 times.



Use caution with the **timed cooking** or **delay timed cooking** features. Use these features when cooking cured or frozen meats and most fruits and vegetables. Foods that can easily spoil, such as milk, eggs, fish, meat or poultry, should be chilled in the refrigerator first. Even when chilled, they should not stand in the oven for more than 1 hour before cooking begins, and should be removed promptly when cooking is completed. Eating spoiled food can result in sickness from food poisoning.

## DELAY TIMED COOKING

In a delay timed cooking, the oven's timer turns the oven on and off at times you select in advance.

- You can use the delay timed cooking feature only with another cooking operation (bake, convection bake, or convection roast).
- You can set the oven for a delay timed cooking before setting other cooking operations.
- The clock must be set to the current time.

### How to set the oven for delay timed cooking

1. Position the oven rack(s) and place the food in the oven.

2. Enter the setup.

Press the pad for the cooking operation you want, eg. BAKE. The default temperature is 350°F.

3. Use the number pads to enter the temperature you want, eg. 375°F.

4. Press the **COOKING TIME** pad.

5. Enter the cooking time you want, eg. 45 min, by using the number pad.

You can set the cooking time for any amount of time from 1 minute to 9 hours and 99 minutes.

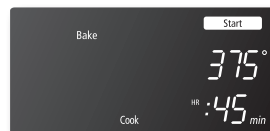

6. Press the **DELAY START** pad.

"AM, PM" is not displayed in 24 hour mode.

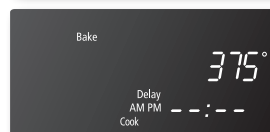

7. Select AM or PM.

Press the **CLOCK AM/PM** pad once to select AM or twice to select PM.

This step is skipped in the 24-hour display mode.

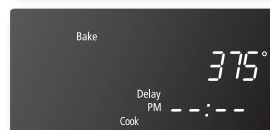

8. Enter the time you want the oven to turn on, eg. 4:30, by using the number pads.

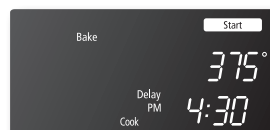

9. Press the **SET/START** pad.

At the set time, a short beep will sound. The oven will begin to bake. When the oven has reached the desired temperature, a long beep will sound 6 times.

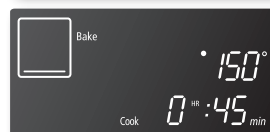
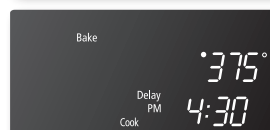

- ★ Place food in the oven after preheating if the recipe calls for it. Preheating is important for good results when baking cakes, cookies, pastry, and breads. After the oven has reached the desired temperature, a long beep will sound 6 times.

# BROILING

## Broil stop position

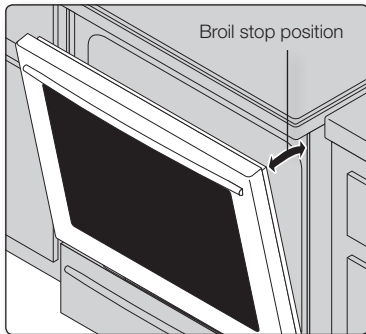

Leave the door open to the broil stop position. The door will stay open by itself, yet the proper temperature is maintained in the oven.

## Using the broil pan

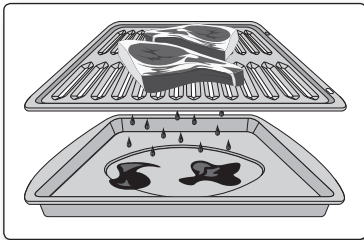

The broil pan and the insert allow grease to drain and be kept away from the high heat of the broiler.

- **Do not** use the pan without the insert.
- **Do not** cover the insert with foil; the exposed grease could ignite.



Should an oven fire occur, close the oven door and turn the oven off. If the fire continues, throw baking soda on the fire or use a foam-type fire extinguisher. Do not put water or flour on the fire. Flour may be explosive and water can cause a grease fire to spread and cause personal injury.

## How to set the oven for broiling

1. Select the broil setting you want.

Press the **BROIL** pad once for HI or twice for LO.

Use LO to cook foods such as poultry or thick cuts of meat thoroughly without over-browning them.

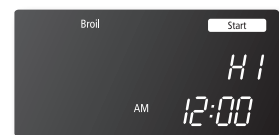

2. Start the broiling function.

Press the **SET/START** pad.

Broil on one side until food is browned; turn and cook on the other side.

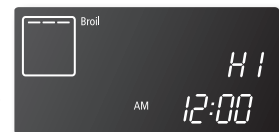

3. Press the **CLEAR/OFF** pad once you have finished cooking or if you want to cancel broiling.

## Recommended broiling guide

The size, weight, thickness, starting temperature, and your preference of doneness will affect broiling times.

This guide is based on meats at refrigerator temperature.

Food	Quantity and/or thickness	Shelf position	First side time (min.)	Second side time (min.)	Comments
<b>Ground Beef</b> Well Done	1 lb. (4 patties) ½ to ¾" thick	7	8-10	4-6	Space evenly. Up to 8 patties may be broiled at once.
<b>Beef Steaks</b>					
Rare	1" thick 1 to 1½ lbs.	7	8	3-5	Steaks less than 1" thick. Cook through before browning.
Medium		7	10	4-6	
Well Done		7	12	5-7	
Rare	1½" thick 2 to 2½ lbs.	6	14	7-9	Pan frying is recommended. Slash fat.
Medium		6	16	8-11	
Well Done		6	19	11-13	
<b>Chicken</b>	1 whole cut up 2 to 2½ lbs., split lengthwise	4	23-28	13-18	Broil skin-side-down first.
	2 Breasts	5	13-18	5-10	
<b>Lobster Tails</b>	2-4 10 to 12 oz. each	4	14-18	Do not turn over.	Cut through back of shell. Spread open. Brush with melted butter before broiling and halfway through broiling time.
<b>Fish Fillets</b>	¼ to ½" thick	6	5-9	3-4	Handle and turn very carefully. Brush with lemon butter before and during cooking, if desired.
<b>Ham Slices</b> (precooked)	½" thick	6	5-7	3-5	Increase time 5 to 10 minutes per side for 1½" thick or home-cured ham.
<b>Pork Chops</b>	2 (½" thick)	6	7	6-8	Slash fat.
Well Done	2 (1" thick) about 1 lb.	5	9-10	7-9	
<b>Lamb Chops</b>					
Medium	2 (1" thick) about 10 to 12 oz.	6	6	4-6	Slash fat.
Well Done		6	8	7-9	
Medium	2 (1½" thick) about 1 lb.	6	11	9	
Well Done		6	13	9-11	
<b>Salmon</b>	2 (1" thick)	6	8	3-4	Grease pan. Brush steaks with melted butter.
Steaks	4 (1" thick) about 1 lb.	6	9	4-6	

## USING THE CUSTOM COOK FEATURE

---

By using the custom cook feature, you can record up to 3 different recipe settings. The feature may be used for baking, convection baking, or convection roasting. It will not work with any other function, including the delay start feature.

### How to record a recipe setting

---

1. Press the pad for the cooking operation you want to store, eg. BAKE. The default temperature is 350°F.
2. Use the number pad to enter the temperature you want, eg. 375°F.
3. Press the **CUSTOM COOK** pad the number of times corresponding to where you want to store the setting, eg. for recipe setting 2, press the **CUSTOM COOK** pad twice.  
Recipe settings can be stored at 1, 2, or 3.

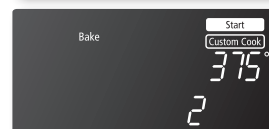
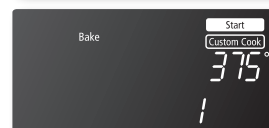
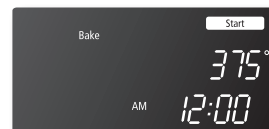

4. Press the **SET/START** pad.

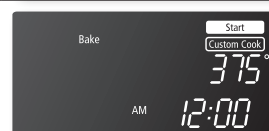

### How to recall a setting

---

1. Press the **CUSTOM COOK** pad the number of times corresponding to where the recipe setting is stored, eg. for recipe setting 2, press the **CUSTOM COOK** pad twice.

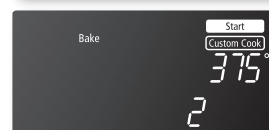
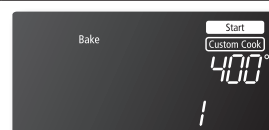

2. Start the stored cooking operation.  
Press the **SET/START** pad.

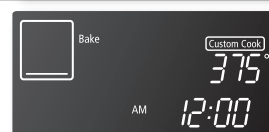



# PROOFING

The proofing feature maintains a warm environment useful for rising yeast-leavened products.

## How to set the oven for proofing

1. Enter the proofing mode.

Press the **PROOF** pad.

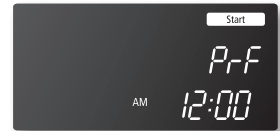

2. Start the proofing function.

Press the **SET/START** pad.

The proofing feature automatically provides the optimum temperature for the proof process, and therefore does not have a temperature adjustment.

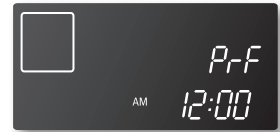

3. Press the **CLEAR/OFF** pad at any time to turn off the proofing feature.



- If you press the **PROOF** pad when the oven temperature is above 100°F, **Hot** will appear in the display. Because these functions produce the best results when started while the oven is cool, we recommend that you wait until the oven has cooled down and Hot disappears from the display.
- To avoid lowering the oven temperature and lengthening proofing time, do not open the oven door unnecessarily.
- Check bread products early to avoid over-proofing.
- Do not use the proofing mode for warming food or keeping food hot. The proofing oven temperature is not hot enough to hold foods at safe temperatures. Use the keep warm feature (see next page).
- For best results, cover the dough with a cloth or with plastic wrap (the plastic may need to be anchored underneath the container so the oven fan will not blow it off).

## USING THE KEEP WARM FUNCTION

---

The keep warm feature will maintain an oven temperature of 170°F. You should not use this feature to reheat cold foods. The keep warm feature will keep cooked food warm for serving up to 3 hours after cooking has finished.

After 3 hours, the feature will shut the oven off automatically. The feature may be used without any other cooking operations or may be set to activate after a timed or delay timed cooking operation.

### How to use the keep warm feature

---

1. Press the **KEEP WARM** pad.

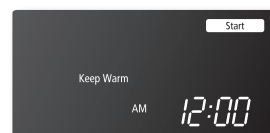

2. Press the **SET/START** pad.

3. Press the **CLEAR/OFF** pad at any time to turn the feature off.

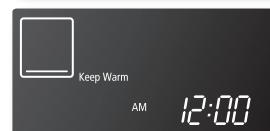

### How to set the oven to activate the keep warm mode after a timed cooking

---

1. Press the **KEEP WARM** pad during a cooking operation, eg. baking.

The oven is now programmed to activate the keep warm mode automatically after completing the cooking operation.

2. Press the **CLEAR/OFF** pad at any time to turn the feature off.



## EXTRA FEATURES

---

### 12 hour energy saving

---

With this feature, should you forget and leave the oven on, the control will automatically turn off the oven after 12 hours during baking functions or after 3 hours during a broil function.

#### How to turn 12 hour energy saving feature on or off

---

1. Press **COOKING TIME** and the **0** number pad at the same time for 3 seconds.

The display will show **12 Hr** (12 hour shut-off) or **-- Hr** (no shut-off).

The default is 12 Hr.



2. Press the **0** number pad to select OFF or ON.

Pressing the **0** number pad changes the mode between 12 Hr and -- Hr.



3. Press the **SET/START** pad..
- 

### Fahrenheit or Celsius temperature selection

---

The oven control can be programmed to display temperatures in Fahrenheit or Centigrade. The oven has been preset at the factory to display in Fahrenheit.

#### How to change the display from Fahrenheit to Centigrade or from Centigrade to Fahrenheit

---

1. Press **BROIL** and the **0** number pad at the same time for 3 seconds.

The display shows **F** (Fahrenheit) or **C** (Centigrade).

The default is F.



2. Press the **0** number pad to select F or C.

Pressing the **0** number pad changes the display between F and C.



3. Press the **SET/START** pad.
-

## Convection auto conversion feature

---

When using convection bake, the convection auto conversion feature will automatically convert entered regular baking temperatures to convection baking temperatures.

This feature is activated so that the display will show the actual converted (reduced) temperature. For example, if you enter a regular recipe temperature of 350°F and press the Set/Start pad, the display will show the converted temperature of 325°F.

### How to disable or enable the auto conversion feature

---

1. Press **CONV. BAKE** and the **0** number pad at the same time for 3 seconds.

The display will show **Con On** (enabled) or **Con OFF** (disabled).

The default setting is Con On.



2. Press the **0** number pad to select Con On or Con OFF.

Pressing the **0** number pad changes the mode between Con On and Con OFF.



3. Press the **SET/START** pad.
- 

## Thermostat adjustment

---

The temperature in the oven has been preset at the factory. When first using the oven, be sure to follow recipe times and temperatures. If you think the oven is too hot or too cool, the temperature in the oven can be adjusted. Before adjusting, test a recipe by using a temperature setting that is higher or lower than the recommended temperature. The baking results should help you to decide how much of an adjustment is needed.

The oven temperature can be adjusted  $\pm 35^{\circ}\text{F}$  ( $\pm 19^{\circ}\text{C}$ ).

### How to adjust the oven temperature

---

1. Press **BAKE** and the **0** number pad at the same time for 3 seconds.

The display will show **AdJ 0**.



2. Enter the adjustment you want, eg. 20°F, by using the number pads.

You can adjust the temperature to lower than the factory setting by pressing the **BAKE** pad.



3. Press the **SET/START** pad.
- 



This adjustment will not affect the broiling or the self-cleaning temperatures. The adjustment will be retained in memory after a power failure.

## Sound on/off

---

By using this feature, you can set the oven controls to operate silently.

### How to turn the sound on or off

---

1. Press **Oven Light** and the **0** number pad at the same time for 3 seconds.

The display will show **Snd On** (sound on) or **Snd OFF** (sound off).

The default setting is Snd On.



2. Press the **0** number pad to select OFF or ON.

Pressing the **0** number pad changes the mode between Snd On and Snd OFF.



3. Press the **SET/START** pad.
- 

## Control lockout

---

This feature will allow you to lock the buttons on the touch pad so they cannot be activated accidentally.

### How to activate the control lockout feature

---

1. Press the **CLEAR/OFF** pad for 3 seconds.

The display will show Loc and a Lock icon continuously, as well as the current time.

All functions must be cancelled before the control lockout is activated.

This function is available under 400°F.

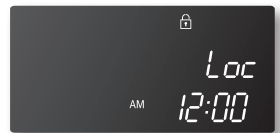

### How to unlock the controls

---

1. Press the **CLEAR/OFF** pad for 3 seconds.

**Loc** and the **lock icon** will disappear from the display.

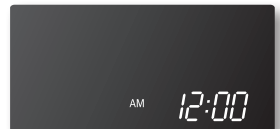

## TURNING THE OVEN LIGHT ON AND OFF

---

- The oven light turns on automatically when the door is opened.
- The oven light turns off automatically when the door is closed.
- You can turn the oven light on and off manually by pressing the OVEN LIGHT pad.

## Setting the Sabbath

### (For use on the Jewish Sabbath & Holidays)

The Sabbath feature can be used with baking only. The oven temperature may be set higher or lower after setting the Sabbath feature (the oven temperature adjustment feature should be used only during Jewish holidays). The display, however, will not change and tones will not sound when a change occurs. Once the oven is properly set for baking with the Sabbath feature active, the oven will remain continuously on until cancelled. This will override the factory preset 12 hour energy saving feature. If the oven light is needed during the Sabbath, press the **OVEN LIGHT** pad before activating the Sabbath feature. Once the oven light is turned on and the Sabbath feature is active, the oven light will remain on until the Sabbath feature is turned off. If the oven light needs to be off, be sure to turn the oven light off before activating the Sabbath feature.

### How to use the Sabbath feature

1. Press the **BAKE** pad.

The default temperature is 350°F.

2. Enter the temperature you want, eg. 375°F, by using the number pad.

3. Press the **SET/START** pad.

The temperature display will start to change once the oven temperature reaches 150°F.

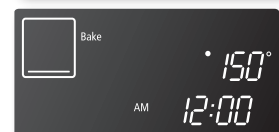
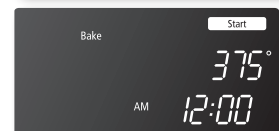
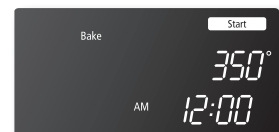

4. Press the **CLOCK AM/PM** and the **KITCHEN TIMER ON/OFF** pads at the same time for 3 seconds.

The display will show **SAb**.

Once SAb appears in the display, the oven control will no longer beep or display any further changes.

You may change the oven temperature once baking has started. Remember that the oven control will no longer beep or display any further changes once the Sabbath feature.

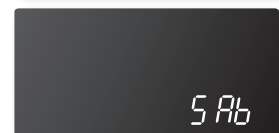

5. You can turn the oven off at any time by pressing the **CLEAR/OFF** pad. This will turn only the oven off. If you want to deactivate the Sabbath feature, hold down the **CLOCK AM/PM** and **KITCHEN TIMER ON/OFF** pads at the same time for 3 seconds. Sab will disappear from the display.



It is not advised to attempt to activate any other program feature except BAKE while the Sabbath feature is active. ONLY the following key pads will function correctly with the Sabbath feature: **NUMBER, BAKE, SET/START and CLEAR/OFF pad**. **ALL OTHER KEYPADS** should not be used once the Sabbath feature is activated.

# maintaining your appliance

## SELF-CLEANING

This self-cleaning oven uses high temperatures (well above cooking temperatures) to burn off leftover grease and residue completely or reduce them to a finely powdered ash that you can wipe away with a damp cloth.



- During the self-cleaning cycle, the outside of the range will become very hot to the touch. **Do not** leave small children unattended near the appliance.
- The health of some birds is extremely sensitive to the fumes given off during the self-cleaning cycle of any range. Move birds to another well-ventilated room.
- **Do not** line the oven walls, racks, bottom or any other part of the range with aluminum foil. Doing so will result in poor heat distribution, produce poor baking results and cause permanent damage to the oven interior (aluminum foil will melt to the interior surface of the oven).
- **Do not** force the oven door open. This can damage the automatic door locking system. Use care when opening the oven door after the self-cleaning cycle is complete. Stand to the side of the oven when opening the door to allow hot air or steam to escape. The oven may still be **VERY HOT**.

### Before a self-cleaning cycle

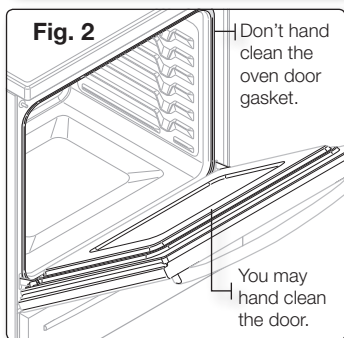
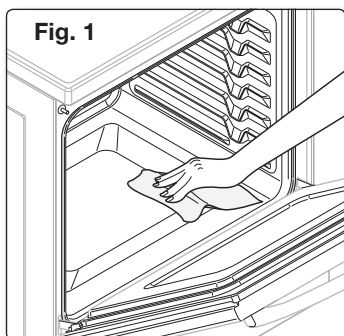

- We recommend venting your kitchen with an open window or using a ventilation fan or hood during the self-cleaning cycle.
- Remove the wire rack, broil pan, broil pan insert, all cookware and any aluminum foil from the oven.
- Wipe up debris from the oven bottom. (Fig. 1)
- The silver-colored oven racks can be self-cleaned, but they will darken, lose their luster and become hard to slide.
- Residue on the front frame of the range and outside the gasket on the door will need to be cleaned by hand. Clean these areas with hot water, soap-filled steel-wool pads or cleansers such as Soft Scrub. Rinse well with clean water and dry.
- Do not clean the gasket. The fiberglass material of the oven door gasket cannot withstand abrasion. It is essential for the gasket to remain intact. If you notice it becoming worn or frayed, replace it. (Fig. 2)
- Make sure the oven light bulb cover is in place and the oven light is off.

## How to set the oven for self-cleaning

---

1. Select the length of time for the self-cleaning operation, eg. 3 hours.

Press the **SELF CLEAN** pad once for a 3 hour clean time, twice for a 4 hour clean time, or 3 times for a 2 hour clean time.

The default setting is 3 hours.

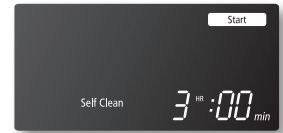

2. Start the self-cleaning cycle.

Press the **SET/START** pad. The motor-driven door lock will engage automatically.

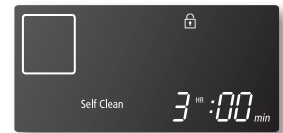

- ★ You will not be able to start a self-cleaning cycle if the control lockout feature is activated or if the oven's temperature is too hot.
- The oven door locks automatically. The display will show the clean time remaining. It is not possible to open the oven door until the temperature drops to a safe/cool temperature.
- The self-cleaning feature will not operate when a surface element is on. If a surface element gets turned on during a self-cleaning cycle, the cycle will turn off automatically.

## How to delay the start of self-cleaning

---

1. Press the **SELF CLEAN** pad.  
Select the desired self-clean time by pressing the **SELF CLEAN** pad.
2. Press the **DELAY START** pad.
3. Using the **CLOCK AM/PM** and number pads, enter the time you want the clean cycle to start.
4. Press the **SET/START** pad.  
The display will show **Delay, Self clean** and Lock icon. The motor-driven door lock will engage automatically.
5. Self-Cleaning cycle will turn on automatically at the set time.

## How to turn off the self-cleaning feature

---

You may find it necessary to stop or interrupt a self-cleaning cycle due to smoke in the oven. (When the self-cleaning cycle is done, End will show in the display and a beep will sound 6 times.)

1. Press the **CLEAR/OFF** pad.
2. You will be able to open the oven door once the oven has cooled down for approximately 1 hour.

## After a self-cleaning cycle

---

- You may notice some white ash in the oven. Wipe it up with a damp cloth after the oven cools. (If white spots remain, remove them with a soap-filled steel wool pad and rinse thoroughly with a vinegar and water mixture.)
- If the oven is not clean after one cycle, repeat the cycle.
- You cannot set the oven for cooking until the oven is cool enough for the door to unlock.



## STEAM-CLEANING

### How to set the oven for steam-cleaning

Steam-cleaning saves time and energy for light cleaning. For heavier-duty cleaning of debris and grease, use the self-cleaning function.

1. Remove all accessories from the oven.
2. Pour approximately 10 oz. (300 ml) of water onto the bottom of the empty oven and close the oven door.  
Use normal water only, no distilled water.

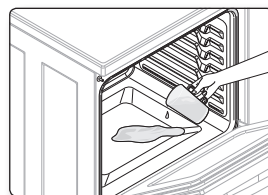

3. Press the **STEAM CLEAN** pad.

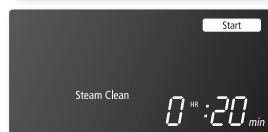

4. Press the **SET/START** pad.  
When the operation is complete, the display will blink and a beep will sound.

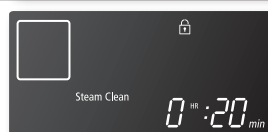

5. Press the **CLEAR/OFF** pad.
6. Clean the oven's interior.  
There will be a significant amount of water remaining on the bottom of the oven after a steam-cleaning cycle. Remove the residual water with a sponge or soft dry cloth.

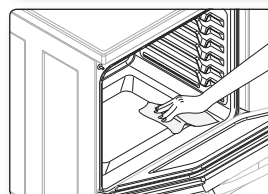

- ★ When steam-cleaning, use exactly 10 oz. of water since this produces the best results.
- ✍ If you press the **STEAM CLEAN** pad when the oven temperature is above 100°F, **Hot** will appear in the display. Because these functions produce the best results when started while the oven is cool, we recommend that you wait until the oven has cooled down and Hot disappears from the display.

### After a steam-cleaning cycle

- Take care when opening the door before a steam-cleaning procedure has ended; the water on the bottom is hot.
- Open the oven door and remove the remaining water with a sponge. Do not leave the residual water in the oven for any length of time. Wipe the oven clean and dry with a soft cloth (do not forget to wipe under the oven door seal).
- Use a detergent-soaked sponge, a soft brush, or a nylon scrubber to wipe the oven interior. Remove stubborn residue with a nylon scourer. You can remove lime deposits with a cloth soaked in vinegar.
- If the oven remains dirty, you can repeat the procedure once the oven has cooled.
- For heavy residue, such as grease left over from roasting, we recommend that you rub detergent into the residue before activating the steam-cleaning function.
- After cleaning, leave the oven door ajar at a 15° angle to allow the interior enamel surface to dry thoroughly.

## CARE AND CLEANING OF THE OVEN



- Be sure all controls are OFF and all surfaces are COOL before cleaning any part of the range.
- If your range is removed for cleaning, servicing or any reason, be sure the Anti-Tip device is re-engaged properly when the range is replaced. Failure to take this precaution could result in tipping of the range and cause injury.



### Oven vent

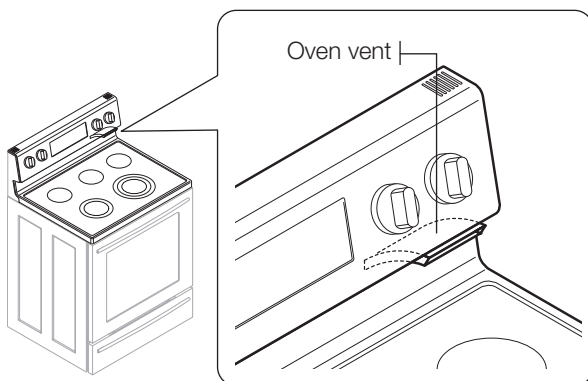

- The oven vent is located above the right rear surface unit.
- This area could become hot during oven use.
- It is normal for steam to come out of the vent.
- The vent is important for proper air circulation. Never block this vent.

### Cleaning painted parts and decorative trim

- For general cleaning, use a cloth with hot and soapy water.
- For more difficult residue and built-up grease, apply a liquid detergent directly onto the area and leave for 30 to 60 minutes. Wipe with a damp cloth and dry. Do not use abrasive cleaners on any of these surfaces; they can scratch.

### Cleaning stainless steel surfaces

1. Shake the bottle of Stainless Steel Appliance Cleaner or polish well.
2. Place a small amount of stainless steel appliance cleaner or polish on a damp cloth or damp paper towel.
3. Clean a small area, rubbing with the grain of the stainless steel if applicable.
4. Dry and buff with a clean, dry paper towel or soft cloth.
5. Repeat as necessary.



- **Do not use a steel-wool pad; it will scratch the surface.**
- If a mineral oil-based stainless steel appliance cleaner has been used before to clean the appliance, wash the surface with dishwashing liquid and water prior to using the Stainless Steel Appliance Cleaner or polish.

## Cleaning the broil pan and insert

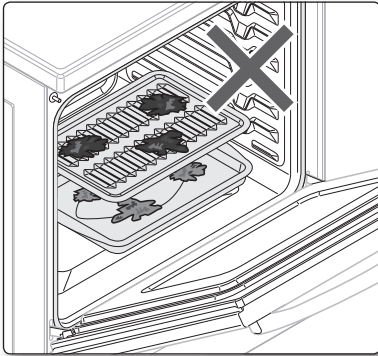

- **Do not attempt to clean the broil pan or insert by leaving it in the oven during a self-cleaning cycle.**
- After broiling, remove the broil pan from the oven. Remove the insert from the pan. Carefully pour out the grease from the pan into a proper container.
- **Wash and rinse the broil pan and grid in hot water with a soap-filled scouring pad.**
- Soaking the pan will remove burned-on foods.
- Both the broil pan and insert may be cleaned with a commercial oven cleaner and are dishwasher-safe.
- **Do not store a soiled broil pan and insert anywhere in the range.**

## Oven racks

- If the racks are left in the oven during a self-cleaning cycle, their color will turn slightly blue and the finish will be dull. After the self-cleaning cycle is complete and the oven has cooled, rub the sides of the racks with wax paper or a clothing containing a small amount of cooking oil. This will help the racks glide more easily into their tracks.

## Oven door

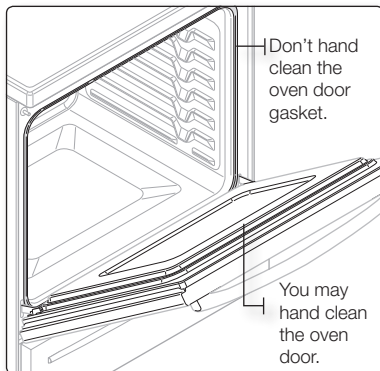

- Use soap & water to thoroughly clean the top, sides, and front of the oven door. Rinse well. You may use a glass cleaner on the outside glass of the oven door. **DO NOT** immerse the door in water. **DO NOT spray or allow water or the glass cleaner to enter the door vents.** **DO NOT** use oven cleaners, cleaning powders, or any harsh abrasive cleaning materials on the outside of the oven door.
- **DO NOT clean the oven door gasket.** The oven door gasket is made of a woven material which is essential for a good seal. Care should be taken not to rub, damage or remove this gasket.

## CARE AND CLEANING OF THE GLASS COOKTOP

---

### Normal daily use cleaning

---

Use only a ceramic cooktop cleaner or the cleaner supplied with this appliance on the glass cooktop. Other creams may not be as effective.

By following these steps, you can maintain and protect the surface of your glass cooktop.

1. Before using the cooktop for the first time, clean it with a ceramic cooktop cleaner or the included cleaner. This helps protect the top and makes cleanup easier.
2. Daily use of a ceramic cooktop cleaner or the included cleaner will help keep the cooktop looking new.
3. Shake the cleaning cream well. Apply a few drops of cleaner directly to the cooktop.
4. Use a paper towel or a cleaning pad for ceramic cooktops to clean the entire cooktop surface.
5. Use a dry cloth or paper towel to remove all cleaning residue. No need to rinse.



**DAMAGE** to your glass surface may occur if you use scrub pads other than those recommended.

### Removing burned-on residue

---

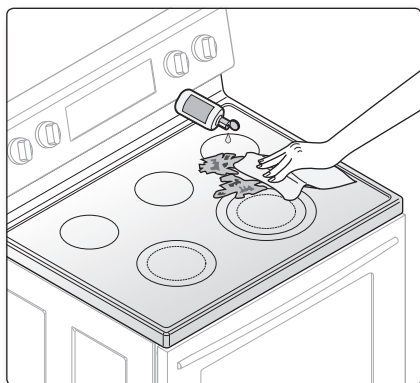

1. Allow the cooktop to cool.
2. Spread a few drops of ceramic cooktop cleaner on the entire burned residue area.
3. Using the included cleaning pad for ceramic cooktops, rub the residue area, applying pressure as needed.
4. If any residue remains, repeat the steps listed above as needed.
5. For additional protection, after all residue has been removed, polish the entire surface with ceramic cooktop cleaner and a paper towel.

### Removing heavy, burned-on residue

---

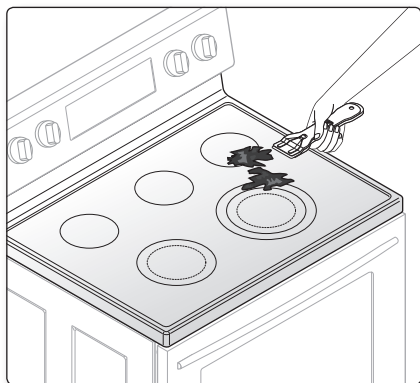

1. Allow the cooktop to cool.
2. Use a single-edge razor-blade scraper at approximately a 45° angle against the glass surface and scrape the soil. It will be necessary to apply pressure in order to remove the residue.
3. After scraping with the razor scraper, spread a few drops of ceramic cooktop cleaner on the entire burned residue area. Use the included cleaning pad to remove any remaining residue. (Do not scrape the seal.)
4. For additional protection, after all residue has been removed, polish the entire surface with the included cooktop cleaner and a paper towel.

## Removing metal marks and scratches

---

1. Be careful not to slide pots and pans across your cooktop. It will leave marks on the cooktop surface. You can remove these marks by applying ceramic cooktop cleaner or the included cleaner with a cleaning pad for ceramic cooktops.
2. If pots with a thin overlay of aluminum or copper are allowed to boil dry, the overlay may leave black discoloration on the cooktop. You should remove this discoloration immediately or it may become permanent.



Carefully check the bottoms of pans for roughness that may scratch the cooktop.

## Cleaning the cooktop seal

---

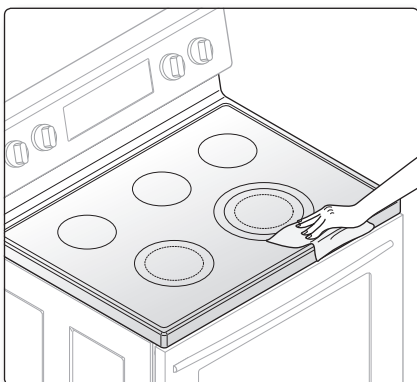

To clean the seal around the edges of the glass, lay a wet cloth on it for a few minutes, then wipe clean with a nonabrasive cleaner.

## Potential for permanent damage to the glass surface

---

- Sugary spillovers (such as jellies, fudge, candy, syrups) or melted plastics can cause pitting of the surface of your cooktop. This is not covered under the warranty. You should clean the spill while it is still hot. Take special care when removing hot substances. Refer to the following section.
- When using a scraper, be sure it is new and the razor blade is still sharp; do not use a dull or nicked blade.

## Cleaning sugary spills and melted plastic

---

1. Turn off all surface units. Remove hot pans.
2. Wearing an oven mitt, use a single-edge razor-blade scraper to move the spill to a cool area of the cooktop. Remove the spill with paper towels.
3. Any remaining spillover should be left until the surface of the cooktop has cooled.
4. Don't use the surface units again until all of the residue has been completely removed.



If pitting or indentation in the glass surface has already occurred, the cooktop glass will have to be replaced. In this case, service will be necessary.

# REMOVING AND REPLACING THE OVEN DOOR

## How to remove the door



- The door is very heavy. Be careful when removing and lifting the door. Do not lift the door by the handle.
- Turn the power OFF before removing the door.

1. Open the door completely.
2. Pull the hinge locks down toward the door frame to the unlocked position.

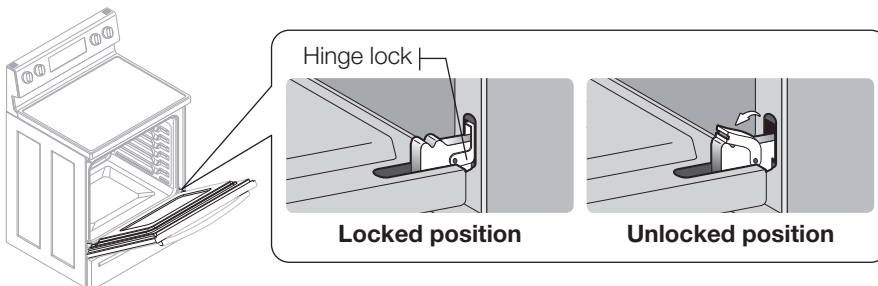

3. Firmly grasp both sides of the door at the top.
4. Close the door to the door removal position, which is approximately 5 degrees from vertical (Fig. 1).
5. Lift door up and out until the hinge arm is clear of the slot (Fig. 2).

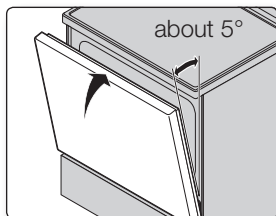

Fig. 1

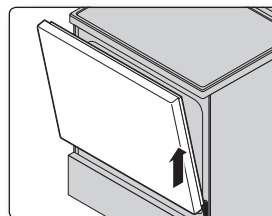
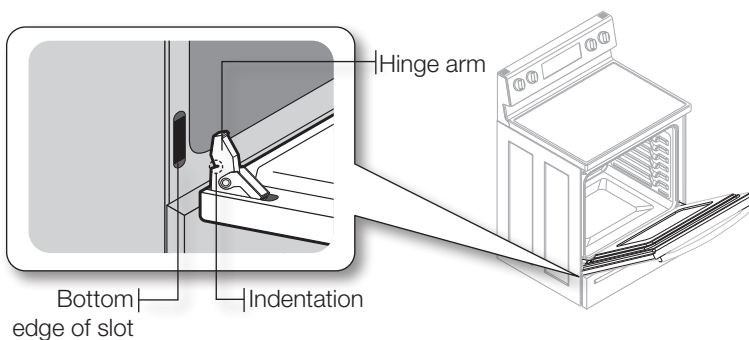

Fig. 2

## How to replace the door

1. Firmly grasp both sides of the door at the top.
2. With the door at the same angle as the removal position, slide the indentation of the hinge arm into the bottom edge of the hinge slot. The notch in the hinge arm must be fully inserted into the bottom of the slot.



3. Open the door fully. If the door will not open fully, the indentation is not inserted correctly in the bottom edge of the slot.
4. Push the hinge locks up against the front frame of the oven cavity to the locked position.

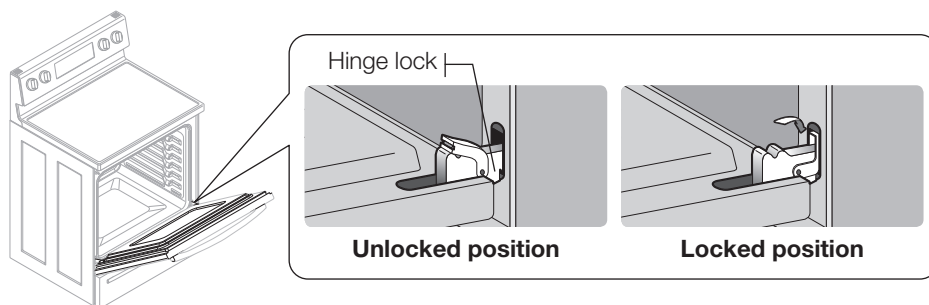

5. Close the oven door.

## REMOVING AND REPLACING THE WARMING DRAWER



Turn the power OFF before removing the warming drawer.

### How to remove the warming drawer

1. Open the drawer to the fully opened position.
2. Locate the glide lever on each side of the drawer; push down on the left glide lever and pull up on the right glide lever.

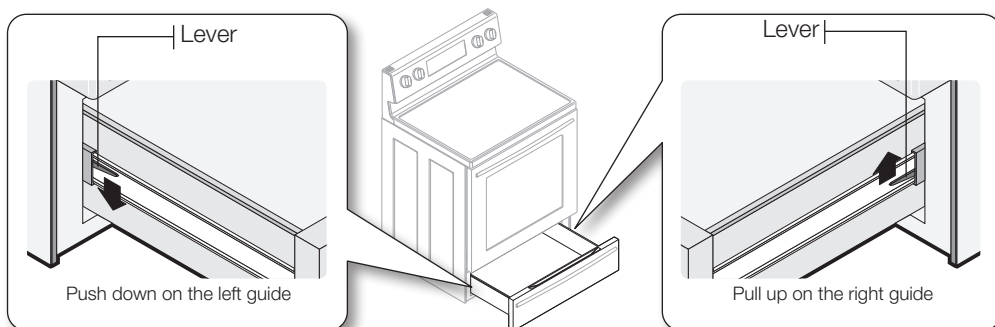

3. Pull the warming drawer away from the range.

### How to replace the warming drawer

1. Replace the shield on the right glide of the drawer body.
2. Pull the bearing glides to the front of the chassis glide.
3. Align the glide on each side of the drawer with the glide slots on the range.
4. Push the drawer into the range until levers click (approximately 2 inches). Pull the drawer open again to seat bearing glides into position. If you do not hear the levers click or the bearing glides do not feel seated, remove the drawer and repeat step 1-This will minimize possible damage to the bearing glides.

## CHANGING THE OVEN LIGHT

The oven light is a standard 40-watt appliance bulb. It will come on when the oven door is open. When the oven door is closed, press the **OVEN LIGHT** pad to turn it on or off. It will not work during a self-cleaning cycle.

1. Make sure the oven and the bulb are cool.
2. Unplug the range or disconnect power.
3. Turn the glass bulb cover in the back of the oven counterclockwise to remove.
4. Turn the bulb counterclockwise to remove it from its socket.

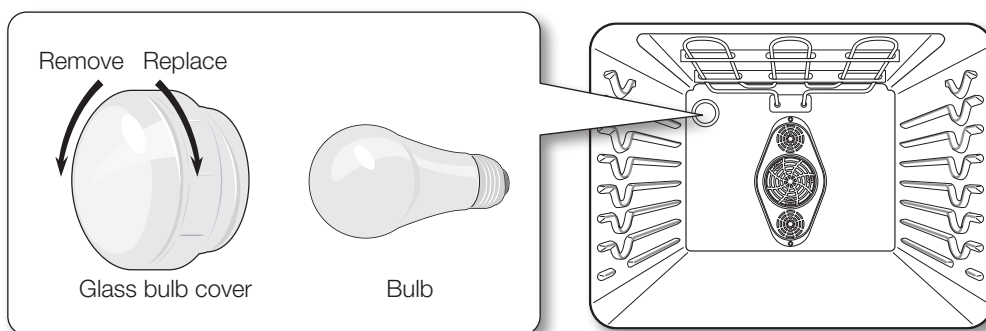

5. Replace the light bulb and glass bulb cover by turning them clockwise.
6. Plug in the range or reconnect power.



Before changing your oven light bulb, disconnect the electrical power to the range at the main fuse or circuit breaker panel. Make sure the oven and the bulb are cool.



# troubleshooting

## TROUBLESHOOTING

Samsung works hard to ensure that you don't have problems with your new electric range. If you run into unexpected trouble, look first for a solution in the table below. If, after trying the suggested solution, you're still having trouble, call Samsung at 1-800-SAMSUNG (1-800-726-7864).

PROBLEM	POSSIBLE CAUSE	SOLUTION														
<b>The range is not level.</b>	The appliance has been installed improperly.	<ul style="list-style-type: none"> <li>Place the oven rack in the center of the oven. Place a level on the oven rack. Adjust the leveling legs at the base of the range until the oven rack is level.</li> <li>Insure the floor is level and strong and stable enough to adequately support the range.</li> </ul>														
	The floor is sagging or sloping.	<ul style="list-style-type: none"> <li>Contact a carpenter to correct the situation.</li> </ul>														
	The kitchen cabinets are not properly aligned and make the range appear to be not level.	<ul style="list-style-type: none"> <li>Insure the cabinets are square and provide sufficient room for installation.</li> </ul>														
<b>The appliance must be accessed for servicing and cannot be moved easily.</b>	The kitchen cabinets are not square and built too tightly in to the appliance.	<ul style="list-style-type: none"> <li>Contact a builder or installer to make the appliance accessible.</li> </ul>														
	The carpet is interfering with movement of the range.	<ul style="list-style-type: none"> <li>Provide sufficient space so the range can be lifted over the carpet.</li> </ul>														
<b>The oven control beeps and displays an F error code.</b>	You have a function error code.	<ul style="list-style-type: none"> <li>Press the <b>CLEAR/OFF</b> pad and restart the oven. If the problem persists, disconnect all power to the range for at least 30 seconds and then reconnect the power. If this does not solve the problem, call for service.</li> </ul>														
	<table border="1"> <thead> <tr> <th>CODE</th> <th>CAUSE</th> </tr> </thead> <tbody> <tr> <td>-SE-</td> <td>Shorted key</td> </tr> <tr> <td>E-27</td> <td>Oven sensor opened</td> </tr> <tr> <td>E-28</td> <td>Oven sensor shorted</td> </tr> <tr> <td>E-08</td> <td>Oven heating error</td> </tr> <tr> <td>E-0A</td> <td>Oven heating over</td> </tr> <tr> <td>E-0E</td> <td>Door locking error</td> </tr> </tbody> </table>		CODE	CAUSE	-SE-	Shorted key	E-27	Oven sensor opened	E-28	Oven sensor shorted	E-08	Oven heating error	E-0A	Oven heating over	E-0E	Door locking error
	CODE		CAUSE													
	-SE-		Shorted key													
	E-27		Oven sensor opened													
	E-28		Oven sensor shorted													
	E-08		Oven heating error													
E-0A	Oven heating over															
E-0E	Door locking error															
<b>The surface units will not maintain a rolling boil or will not cook fast enough.</b>	Improper cookware is being used.	<ul style="list-style-type: none"> <li>Use pans which are flat and match the diameter of the surface unit selected.</li> </ul>														
	In some areas, the power (voltage) may be low.	<ul style="list-style-type: none"> <li>Cover the pan with a lid until the desired heat is obtained.</li> </ul>														
<b>The surface units will not turn on.</b>	A fuse in your home may be blown or the circuit breaker tripped.	<ul style="list-style-type: none"> <li>Replace the fuse or reset the circuit breaker.</li> </ul>														
	The cooktop controls are set improperly.	<ul style="list-style-type: none"> <li>Check to see the correct control is set for the surface unit you are using.</li> </ul>														
<b>The surface unit stops glowing when changed to a lower setting.</b>	This is normal. The unit is still on and hot.															

PROBLEM	POSSIBLE CAUSE	SOLUTION
<b>Areas of discoloration on the cooktop</b>	Food spillover was not cleaned.	<ul style="list-style-type: none"> <li>Refer to the section on care and cleaning of the glass cooktop on page 54.</li> </ul>
	The surface is hot and the model features a light-colored cooktop.	<ul style="list-style-type: none"> <li>This is normal. The surface may appear discolored when it is hot. This is temporary and will disappear as the glass cools.</li> </ul>
<b>The surface unit frequently cycles on and off.</b>	This is normal.	<ul style="list-style-type: none"> <li>The element will cycle on and off to maintain the heat setting.</li> </ul>
<b>The oven will not turn on.</b>	The range is not completely plugged into the electrical outlet.	<ul style="list-style-type: none"> <li>Make sure the electrical plug is inserted into a live, properly grounded outlet.</li> </ul>
	A fuse in your home may be blown or the circuit breaker tripped.	<ul style="list-style-type: none"> <li>Replace the fuse or reset the circuit breaker.</li> </ul>
	The oven controls have been set improperly.	<ul style="list-style-type: none"> <li>See the chapter on operating the oven.</li> </ul>
	The oven is too hot.	<ul style="list-style-type: none"> <li>Allow the oven to cool.</li> </ul>
<b>The appliance will not turn on.</b>	The appliance is not completely plugged into the electrical outlet or a fuse in your home may be blown or the circuit breaker tripped.	<ul style="list-style-type: none"> <li>Make sure the power cord is plugged into a live, properly grounded outlet. Check the fuse and circuit breakers.</li> </ul>
	Incomplete service wiring.	<ul style="list-style-type: none"> <li>Call for service.</li> </ul>
	Power outage.	<ul style="list-style-type: none"> <li>Check to see if the house lights will turn on. If required, call your local electric company for service.</li> </ul>
<b>The oven light will not turn on.</b>	The light bulb is loose or defective.	<ul style="list-style-type: none"> <li>Tighten or replace the bulb.</li> </ul>
	The switch operating light is broken.	<ul style="list-style-type: none"> <li>Call for service.</li> </ul>
<b>Oven smokes excessively during broiling.</b>	The control has not been set properly.	<ul style="list-style-type: none"> <li>Refer to the section on setting oven controls.</li> <li>Make sure the oven door is opened to the broil stop position.</li> </ul>
	The meat has been placed too close to the element.	<ul style="list-style-type: none"> <li>Reposition the rack to provide proper clearance between the meat and the element. Preheat the broil element for searing.</li> </ul>
	The meat has not been properly prepared.	<ul style="list-style-type: none"> <li>Remove the excess fat from the meat. Cut away fatty edges that may curl, leaving the lean intact.</li> </ul>
	The insert on the broiler pan has been positioned upside down, preventing the grease from draining.	<ul style="list-style-type: none"> <li>Position the insert on the pan so that the ribs are up and the slots are down, allowing the grease to drip into the pan.</li> </ul>
	Grease has built up on oven surfaces.	<ul style="list-style-type: none"> <li>Regular cleaning is necessary when broiling frequently.</li> </ul>
<b>Food does not bake or roast properly.</b>	The oven controls have not been set correctly.	<ul style="list-style-type: none"> <li>See the chapter on operating the oven.</li> </ul>
	The oven rack has been positioned incorrectly or is not level.	<ul style="list-style-type: none"> <li>See the section on using the oven racks on page 52.</li> </ul>
	Incorrect cookware or cookware of improper size being used.	
	The oven sensor needs to be adjusted.	<ul style="list-style-type: none"> <li>See the section on adjusting the thermostat on page 46.</li> </ul>

PROBLEM	POSSIBLE CAUSE	SOLUTION
<b>Food does not broil properly.</b>	The oven controls have been set incorrectly.	<ul style="list-style-type: none"> <li>Press the <b>BROIL</b> pad.</li> </ul>
	The rack has not been properly positioned.	<ul style="list-style-type: none"> <li>See the broiling guide on page 41.</li> </ul>
	Cookware not suited for broiling.	<ul style="list-style-type: none"> <li>Use suitable cookware.</li> </ul>
	Aluminum foil used on the broiling pan and grid has not been fitted properly and slit as recommended.	<ul style="list-style-type: none"> <li>See the section on broiling on page 42.</li> </ul>
	In some areas the power (voltage) may be low.	<ul style="list-style-type: none"> <li>Preheat the broil element for 10 minutes.</li> <li>See the broiling guide on page 41.</li> </ul>
<b>The oven temperature is too hot or too cold.</b>	The oven sensor needs to be adjusted.	<ul style="list-style-type: none"> <li>See the section on adjusting the thermostat on page 46.</li> </ul>
<b>Scratches or abrasions on cooktop surface</b>	The cooktop is being cleaned improperly.	<ul style="list-style-type: none"> <li>Scratches are not removable. Tiny scratches will become less visible in time as a result of cleaning.</li> </ul>
	Cookware with rough bottoms were used on the cooktop or there were coarse particles (eg. salt or sand) present between the cookware and the surface of the cooktop.	<ul style="list-style-type: none"> <li>To avoid scratches, use the recommended cleaning procedures. Make sure bottoms of cookware are clean before use, and use cookware with smooth bottoms.</li> </ul>
	Cookware has been slid across the cooktop surface.	
<b>Brown streaks or specks</b>	Boilovers have been cooked onto the surface.	<ul style="list-style-type: none"> <li>Use the blade scraper to remove soil.</li> <li>See the section on care and cleaning of the glass cooktop on page 54.</li> </ul>
<b>Areas of discoloration with metallic sheen</b>	Mineral deposits from water and food have been left on the surface of the cooktop.	<ul style="list-style-type: none"> <li>Remove using a ceramic-glass cooktop cleaning cream.</li> <li>Use cookware with clean, dry bottoms.</li> </ul>
<b>The oven will not self-clean.</b>	The oven temperature is too high to set a self-clean operation.	<ul style="list-style-type: none"> <li>Allow the range to cool and reset the controls.</li> </ul>
	The oven controls have been set incorrectly.	<ul style="list-style-type: none"> <li>See the section on self-cleaning on page 47.</li> </ul>
	A self-cleaning cycle cannot be started if the oven lockout feature has been activated or if a radiant surface element is on.	
<b>“Crackling” or “popping” sound</b>	This is the sound of the metal heating and cooling during both the cooking and cleaning functions.	<ul style="list-style-type: none"> <li>This is normal.</li> </ul>
<b>Excessive smoking during a self-cleaning cycle</b>	There is excessive soiling in the oven.	<ul style="list-style-type: none"> <li>Press the <b>CLEAR/OFF</b> pad. Open the windows to rid the room of smoke. Wait until the self-cleaning cycle is cancelled. Wipe up the excessive soil and reset the oven for self-cleaning.</li> </ul>
<b>The oven door will not open after a self-cleaning cycle.</b>	The oven is too hot.	<ul style="list-style-type: none"> <li>Allow the oven to cool.</li> </ul>

<b>PROBLEM</b>	<b>POSSIBLE CAUSE</b>	<b>SOLUTION</b>
<b>Oven not clean after a self-cleaning cycle</b>	The oven controls were not set correctly.	<ul style="list-style-type: none"> <li>• See the section on self-cleaning on page 49.</li> </ul>
	The oven was heavily soiled.	<ul style="list-style-type: none"> <li>• Wipe up heavy spillovers before starting the self-cleaning cycle. Heavily soiled ovens may need to self-clean again or for a longer period of time.</li> </ul>
<b>Steam from the vent</b>	When using the convection feature, it is normal to see steam coming out of the oven vent.	<ul style="list-style-type: none"> <li>• This is normal.</li> </ul>
	As the number of racks or amount of food being cooked increases, the amount of visible steam will increase.	
<b>Burning or oily odor emitting from the vent</b>	This is normal in a new oven and will disappear in time.	<ul style="list-style-type: none"> <li>• To speed the process, set a self-cleaning cycle for a minimum of 3 hours.</li> <li>• See the section on self-cleaning on page 49.</li> </ul>
<b>Strong odor</b>	An odor from the insulation around the inside of the oven is normal for the first few times the oven is used.	<ul style="list-style-type: none"> <li>• This is temporary.</li> </ul>
<b>Fan noise</b>	A convection fan may automatically turn on and off.	<ul style="list-style-type: none"> <li>• This is normal.</li> </ul>
<b>Oven racks are difficult to slide.</b>	The shiny, silver-colored racks were cleaned in a self-cleaning cycle.	<ul style="list-style-type: none"> <li>• Apply a small amount of vegetable oil to a paper towel and wipe the edges of the oven racks with the paper towel.</li> </ul>
<b>Display goes blank.</b>	A fuse in your home may be blown or the circuit breaker tripped.	<ul style="list-style-type: none"> <li>• Replace the fuse or reset the circuit breaker.</li> </ul>
<b>Display flashes.</b>	There was a power failure.	<ul style="list-style-type: none"> <li>• Reset the clock.</li> </ul>
<b>Drawer does not slide smoothly or drags.</b>	The drawer is out of alignment.	<ul style="list-style-type: none"> <li>• Fully extend the drawer and push it all the way in. See the page 57.</li> </ul>
	The drawer is over-loaded or the load is unbalanced.	<ul style="list-style-type: none"> <li>• Reduce weight. Redistribute drawer contents.</li> </ul>
<b>Warming drawer will not work.</b>	A fuse in your home may be blown or the circuit breaker tripped.	<ul style="list-style-type: none"> <li>• Replace the fuse or reset the circuit breaker.</li> </ul>
	The controls are not set correctly.	<ul style="list-style-type: none"> <li>• See the chapter on using the warming drawer on page 27.</li> </ul>
<b>Excessive condensation in the drawer</b>	There is liquid present in the drawer.	<ul style="list-style-type: none"> <li>• Remove the liquid.</li> </ul>
	Uncovered foods.	<ul style="list-style-type: none"> <li>• Cover food with a lid or aluminum foil.</li> </ul>
	The temperature is set too high.	<ul style="list-style-type: none"> <li>• Adjust the temperature to a lower setting.</li> </ul>
<b>Food dries out in the warming drawer.</b>	Moisture is escaping.	<ul style="list-style-type: none"> <li>• Cover food with a lid or aluminum foil.</li> </ul>
	The drawer is not fully closed.	<ul style="list-style-type: none"> <li>• Push the drawer in until the latch engages.</li> </ul>

**PLEASE DO NOT DISCARD THIS REPLACES THE WARRANTY PAGE IN THE USE & CARE GUIDE**

## **SAMSUNG ELECTRIC RANGE**

### **LIMITED WARRANTY TO ORIGINAL PURCHASER**

This SAMSUNG brand product, as supplied and distributed by SAMSUNG ELECTRONICS CANADA INC. (SAMSUNG) and delivered new, in the original carton to the original consumer purchaser, is warranted by SAMSUNG against manufacturing defects in materials and workmanship for a limited warranty period of:

#### **One (1) Year Parts and Labor, Five (5) Years Parts Warranty For Glass Cooktop and Radiant Surface Unit**

**During this limited additional four-year warranty, you will responsible for any labor or in-home service.**

This limited warranty begins on the original date of purchase, and is valid only on products purchased and used in Canada. To receive warranty service, the purchaser must contact SAMSUNG for problem determination and service procedures. Warranty service can only be performed by a SAMSUNG authorized service center, and any unauthorized service will void this warranty. The original dated bill of sale must be presented upon request as proof of purchase to SAMSUNG or SAMSUNG's authorized service center. Samsung will provide in-home service during the one (1) year warranty period at no charge subject to availability within Canada. In home service is not available in all areas. To receive in home service product must be unobstructed and accessible to the service agent. If service is not available Samsung may elect to provide transportation of the product to and from an authorized service center.

SAMSUNG will repair or replace this product, at our option and at no charge as stipulated herein, with new or reconditioned parts or products if found to be defective during the limited warranty period specified above. All replaced parts and products become the property of SAMSUNG and must be returned to SAMSUNG. Replacement parts and products assume the remaining original warranty, or ninety (90) days, whichever is longer.

This limited warranty covers manufacturing defects in materials and workmanship encountered in normal, noncommercial use of this product and shall not apply to the following: damage which occurs in shipment; delivery and installation; applications and uses for which this product was not intended; altered product or serial numbers; cosmetic damage or exterior finish; accidents, abuse, neglect, fire, water, lightning or other acts of nature; use of products, equipment, systems, utilities, services, parts, supplies, accessories, applications, installations, repairs, external wiring or connectors not supplied or authorized by SAMSUNG which damage this product or result in service problems; incorrect electrical line voltage, fluctuations and surges; customer adjustments and failure to follow operating instructions, maintenance and environmental instructions that are covered and prescribed in the instruction book; product removal and reinstallation; problems caused by pest infestations, and overheating or overcooking by user. This limited warranty shall not cover cases of incorrect electric current, voltage or supply, light bulbs, house fuses, house wiring, cost of a service call for instructions, or fixing installation errors. Furthermore, damage to the glass cooktop caused by the use of cleaners other than the recommended cleaners and pads, damage to the glass cook top caused by hardened spills of sugary materials or melted plastic that are not cleaned according to the directions in the use and care guide are not covered. SAMSUNG does not warrant uninterrupted or error-free operation of the product.

EXCEPT AS SET FORTH HEREIN THERE ARE NO WARRANTIES ON THIS PRODUCT EITHER EXPRESS OR IMPLIED AND SAMSUNG DISCLAIMS ALL WARRANTIES INCLUDING, BUT NOT LIMITED TO, ANY IMPLIED WARRANTIES OF MERCHANTABILITY, INFRINGEMENT OR FITNESS FOR A PARTICULAR PURPOSE. NO WARRANTY OR GUARANTY GIVEN BY ANY PERSON, FIRM OR CORPORATION WITH RESPECT TO THIS PRODUCT SHALL BE BINDING ON SAMSUNG. SAMSUNG SHALL NOT BE LIABLE FOR LOSS OF REVENUE OR PROFITS, FAILURE TO REALIZE SAVINGS OR OTHER BENEFITS, OR ANY OTHER SPECIAL, INCIDENTAL OR CONSEQUENTIAL DAMAGES CAUSED BY THE USE, MISUSE OR INABILITY TO USE THIS PRODUCT, REGARDLESS OF THE LEGAL THEORY ON WHICH THE CLAIM IS BASED, AND EVEN IF SAMSUNG HAS BEEN ADVISED OF THE POSSIBILITY OF SUCH DAMAGES. NOR SHALL RECOVERY OF ANY KIND AGAINST SAMSUNG BE GREATER IN AMOUNT THAN THE PURCHASE PRICE OF THE PRODUCT SOLD BY SAMSUNG AND CAUSING THE ALLEGED DAMAGE. WITHOUT LIMITING THE FOREGOING, PURCHASER ASSUMES ALL RISK AND LIABILITY FOR LOSS, DAMAGE OR INJURY TO PURCHASER AND PURCHASER'S PROPERTY AND TO OTHERS AND THEIR PROPERTY ARISING OUT OF THE USE, MISUSE OR INABILITY TO USE THIS PRODUCT. THIS LIMITED WARRANTY SHALL NOT EXTEND TO ANYONE OTHER THAN THE ORIGINAL PURCHASER OF THIS PRODUCT, IS NONTRANSFERABLE AND STATES YOUR EXCLUSIVE REMEDY.

Some states do not allow limitations on how long an implied warranty lasts, or the exclusion or limitation of incidental or consequential damages, so the above limitations or exclusions may not apply to you. This warranty gives you specific legal rights, and you may also have other rights which vary from state to state.

To obtain warranty service, please contact SAMSUNG at:

**SAMSUNG ELECTRONICS CANADA INC.,  
55 STANDISH COURT MISSISSAUGA ONTARIO, L5R 4B2  
1-800-SAMSUNG (726-7864) and [www.samsung.com/ca](http://www.samsung.com/ca)**



QUESTIONS OR COMMENTS?

COUNTRY	CALL	OR VISIT US ONLINE AT
IN THE US	1-800-SAMSUNG(726-7864)	<a href="http://www.samsung.com/us">www.samsung.com/us</a>
IN CANADA	1-800-SAMSUNG(726-7864)	<a href="http://www.samsung.com/ca">www.samsung.com/ca</a>

DG68-00294A\_EN

## Free Manuals Download Website

<http://myh66.com>

<http://usermanuals.us>

<http://www.somanuals.com>

<http://www.4manuals.cc>

<http://www.manual-lib.com>

<http://www.404manual.com>

<http://www.luxmanual.com>

<http://aubethermostatmanual.com>

Golf course search by state

<http://golfingnear.com>

Email search by domain

<http://emailbydomain.com>

Auto manuals search

<http://auto.somanuals.com>

TV manuals search

<http://tv.somanuals.com>