

SCC-B5367
SCC-B5369
SCC-B5367S
SCC-B5369S

DIGITAL COLOR DOME CAMERA

user manual

ENG

FRC

SPA-M

JAP

POR-B

imagine the possibilities

Thank you for purchasing this Samsung product.
To receive more complete service,
please register your product at
www.samsungsecurity.com



Safety information



CAUTION

RISK OF ELECTRIC SHOCK.
DO NOT OPEN



CAUTION: TO REDUCE THE RISK OF ELECTRIC SHOCK, DO NOT REMOVE COVER (OR BACK) NO USER SERVICEABLE PARTS INSIDE. REFER SERVICING TO QUALIFIED SERVICE PERSONNEL.



This symbol indicates that dangerous voltage consisting a risk of electric shock is present within this unit.



This exclamation point symbol is intended to alert the user to the presence of important operating and maintenance (servicing) instructions in the literature accompanying the appliance.

WARNING

- To reduce the risk of fire or electric shock, do not expose this appliance to rain or moisture.
- To prevent injury, this apparatus must be securely attached to the floor/wall in accordance with the installation instructions.
- If this power supply is used at 240V ac, a suitable plug adapter should be used.

WARNING

1. Be sure to use only the standard adapter that is specified in the specification sheet. Using any other adapter could cause fire, electrical shock, or damage to the product.
2. Incorrectly connecting the power supply or replacing battery may cause explosion, fire, electric shock, or damage to the product.
3. Do not connect multiple cameras to a single adapter. Exceeding the capacity may cause abnormal heat generation or fire.
4. Securely plug the power cord into the power receptacle. Insecure connection may cause fire.
5. When installing the camera, fasten it securely and firmly. The fall of camera may cause personal injury.

2 – DIGITAL COLOR DOME CAMERA

Safety information

6. Do not place conductive objects (e.g. screwdrivers, coins, metal parts, etc.) or containers filled with water on top of the camera. Doing so may cause personal injury due to fire, electric shock, or falling objects.
7. Do not install the unit in humid, dusty, or sooty locations. Doing so may cause fire or electric shock.
8. If any unusual smells or smoke come from the unit, stop using the product. In such case, immediately disconnect the power source and contact the service center. Continued use in such a condition may cause fire or electric shock.
9. If this product fails to operate normally, contact the nearest service center. Never disassemble or modify this product in any way. (SAMSUNG is not liable for problems caused by unauthorized modifications or attempted repair.)
10. When cleaning, do not spray water directly onto parts of the product. Doing so may cause fire or electric shock.

CAUTION

1. Do not drop objects on the product or apply strong blows to it. Keep away from a location subject to excessive vibration or magnetic interference.
2. Do not install in a location subject to high temperature (over 140°F), low temperature (below -14°F), or high humidity. Doing so may cause fire or electric shock.
3. If you want to relocate the already installed product, be sure to turn off the power and then move or reinstall it.
4. Remove the power plug from the outlet when there is a lightning storm. Neglecting to do so may cause fire or damage to the product.
5. Keep out of direct sunlight and heat radiation sources. It may cause fire.
6. Install it in a place with good ventilation.
7. Avoid aiming the camera directly towards extremely bright objects such as sun, as this may damage the CCD image sensor.
8. Apparatus shall not be exposed to dripping or splashing and no objects filled with liquids, such as vases, shall be placed on the apparatus.
9. The Mains plug is used as a disconnect device and shall stay readily operable at any time.

ENG

Safety information

FCC Statement

This device complies with part 15 of the FCC Rules. Operation is subject to the following two conditions :

- 1) This device may not cause harmful interference, and
- 2) This device must accept any interference received including interference that may cause undesired operation.

Caution

This equipment has been tested and found to comply with the limits for a Class A digital device, pursuant to part 15 of FCC Rules. These limits are designed to provide reasonable protection against harmful interference when the equipment is operated in a commercial environment.

This equipment generates, uses, and can radiate radio frequency energy and, if not installed and used in accordance with the instruction manual, may cause harmful interference to radio communications. Operation of this equipment in a residential area is likely to cause harmful interference in which case the user will be required to correct the interference at his own expense.



IC Compliance Notice

This Class A digital apparatus meets all requirements of the Canadian Interference-Causing Equipment Regulations of ICES-003.

Important Safety Instructions

WARNING

1. Read these instructions.
2. Keep these instructions.
3. Heed all warnings.
4. Follow all instructions.
5. Do not use this apparatus near water.
6. Clean only with dry cloth.
7. Do not block any ventilation openings. Install in accordance with the manufacturer's instructions.
8. Do not install near any heat sources such as radiators, heat registers, or other apparatus (including amplifiers) that produce heat.
9. Do not defeat the safety purpose of the polarized or grounding-type plug. A polarized plug has two blades with one wider than the other. A grounding type plug has two blades and a third grounding prong. The wide blade or the third prong is provided for your safety. If the provided plug does not fit into your outlet, consult an electrician for replacement of the obsolete outlet.
10. Protect the power cord from being walked on or pinched particularly at plugs, convenience receptacles, and the point where they exit from the apparatus.
11. Only use attachments/accessories specified by the manufacturer.
12. Use only with cart, stand, tripod, bracket, or table specified by the manufacturer, or sold with the apparatus.
13. Unplug this apparatus when a card is used. Use caution when moving the cart/ apparatus combination to avoid injury from tip-over.
14. Refer all servicing to qualified service personnel. Servicing is required when the apparatus has been damaged in any way, such as powersupply cord or plug is damaged, liquid has been spilled or objects have fallen into the apparatus, the apparatus has been exposed to rain or moisture, does not operate normally, or has been dropped.



Apparatus shall not be exposed to dripping or splashing and no objects filled with liquids, such as vases, shall be placed on the apparatus



ENG

Contents

Introduction

Features	7
Product & Accessories	8
Part Names and Functions	9

Installation

Before installation	12
Installation procedure	12
Adjusting the camera direction	14

How to use OSD Menu

Using Icons in the Menu	15
Main Menu	15
Profile	16
Camera Setup	18
Intelligence	26
Privacy Zone Setup	28
Other Set	30
System Information	30
Language	30

Specifications

Specifications	32
----------------	----

FEATURES

❖ High Resolution

- This camera has realized high resolution of 600 lines using the top-notch full digital image processing and special algorithm technologies.

❖ VPS(Virtual Progressive Scan)

- This is an advanced technology that reproduces a sharp progressive image. This is appropriate to high quality recording and file transfer via the Internet.

❖ Intelligent Motion Detection & Tracking

- This is an intelligent function that automatically detects a motion of an object. You can set a virtual fence so it displays an alert if an object passes / enters /exits the virtual fence or virtual area.

❖ WDR

- WDR extends the contrast range as it takes a picture of each of dark and bright areas before compositing the two, which is useful if you take a picture of windows inside a building. Namely, it improves the picture quality of the outdoor scenery as well as indoor.

❖ XDR (eXtended Dynamic Range)

- Actively controls the gamma compensation in the way it operates the ambient luminance contrast in a certain pixel unit to determine the optimal visibility.

❖ DAY/NIGHT

- This function can make the IR Cut filtering function inactive under the illumination below the normal value.

❖ High Sensitivity

- It implements images of high sensitivity using the up-to-date SONY Super-HAD Progressive CCD.

❖ Low Illumination

- It uses the digital signal technologies such as low illumination and Day/Night functions that make your camera identify objects even in the worst environment.

❖ Superior Backlight Adjustment

- When an object has a bright illumination or sunlight behind it, this camera automatically improves the shaded object picture quality.

❖ Digital Power Synchronization

- The full digital Line Lock function directly adjusts the vertical camera synchronization to enhance the operationability and reliability of this camera.

Introduction

❖ Output Signal Setting

- You can set the following Video output signals: Image reversion (Horizontal, Vertical, or both), Privacy, Horizontal/Vertical profiling, and digital zooming.

❖ OSD(On Screen Display) Menu

- OSD menu is provided to display the status of camera and to configure the functions interactively.

❖ Coaxial Cable Communication

- This is a remote control function that overlaps the coaxial cable (for a transfer of the video signal) with the control signal. In installation or repair, this helps you control the communication controller (optional) without additional cabling.

PRODUCT & ACCESSORIES

❖ Product & Accessories

- Main Product

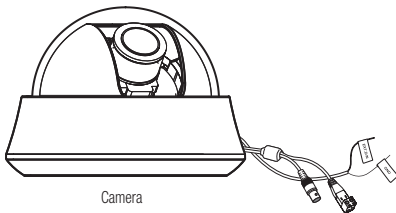

Camera

- Accessories



Test Monitor Cable



Tab screw



User's Manual

■ Note :

- The test monitor cable is used to test the camera by connecting to a portable display. If you really want to connect the camera to a monitoring display, use the BNC cable.

8 – DIGITAL COLOR DOME CAMERA

Introduction

PART NAMES AND FUNCTIONS

❖ Components of your camera

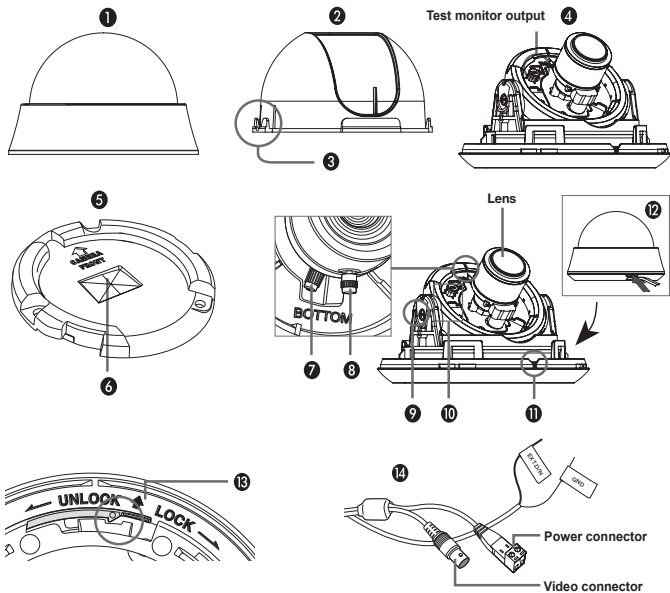

ENG

English - 9

Introduction

No	Name	Brief description
1	Cover dome	Covers the inner cover, lens, and main body to protect them.
2	Inner cover	Covers the main body to protect it.
3	Wing locker	Push a long thin screwdriver into its narrow spot and press it outward when you want to remove the inner cover.
4	Main body	Includes a lens, a switch board, a PCB board, screws, and such.
5	Mount bracket	Used as a ceiling or wall fixture. It is fixed using three long tab screws provided in the package.
6	Wiring Passage	This passage is designed to make arrangement of the cables if you drill a hole to extend the wiring.
7	Zoom lever	Using this lever, the lens zoom can be adjusted and fixed.
8	Focus lever	The lens focus can be adjusted by rotating it left or right. Rotate it clockwise for fixing.
9	Tilt fixing screw	Using this screw, the slope of the lens can be adjusted and fixed.
10	5-way Switch	This switch is used to set and adjust the settings of the camera's functions.
11	Groove mark	To attach the Main body to the Mount bracket, align this groove mark on the Main body with the wide groove in the CAMERA FRONT side on the Mount bracket.
12	Locker	Used to open or close the Cover dome. To open the cover dome, press the locker.
13	Lock releaser	Push it outward and rotate the main body in UNLOCK direction when you want to remove the Mount bracket from the Main body or to remove the installed camera from the Mount bracket.
14	Cable	Connect the Video connector to BNC cable and Power connector to power adapter. EXT. D/N is a port for DAY/NIGHT conversion. High(DC +3V ~ +5V); DAY(COLOR) Mode. Low(0V); NIGHT (BW) Mode.

❖ Setting switches

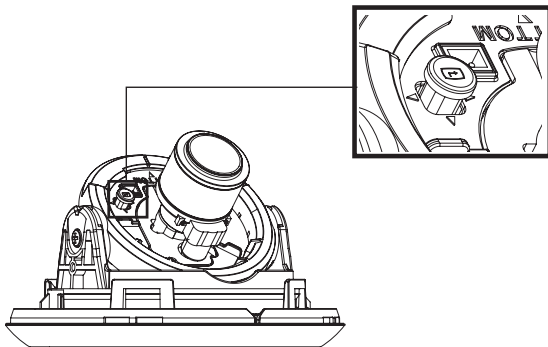

ENG

• SETUP Switch

This switch is used to set the function or property. When this switch is pressed for at least 2 seconds, the MAIN MENU appears.

- ◀ ▶ (Left/Right) : By pressing this switch left or right, you can move left or right on the menu or change the displayed value.
- ▲ ▼ (Up/Down) : By pressing this switch up or down, you can move up or down on the menu.
- ◻ : When you press this switch in the menu, the selected function is confirmed. To enter a submenu, press this button.

Installation

BEFORE INSTALLATION

Before installing your camera, you have to read the following cautions.

- You have to check whether the location (ceiling or wall) can bear five times the weight of your camera.
- Don't let the cable to be caught in improper place or the electric line cover to be damaged. Otherwise it may cause a breakdown or fire.
- When installing your camera, don't allow any person to approach the installation site. If you have any valuable things under the place, move them away.

INSTALLATION PROCEDURE

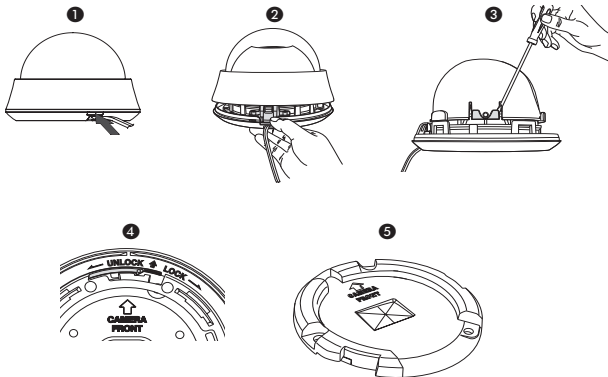

12 – DIGITAL COLOR DOME CAMERA

Installation

- ❶ Press the Locker button on the bottom of your camera and remove the Cover dome from the Main body using the other hand. The Main body and Inner cover will be exposed to you.
- ❷ To install and adjust your camera, you have to first remove the Inner cover. To remove the Inner cover from the Main body, push a long thin screwdriver into the narrow spot of the Wing locker and press it outward to remove the cover.
- ❸ Remove the Mount bracket from the Main body by rotating the Main body in the UNLOCK direction while pushing the Lock releaser outward. If it is not easily done, rotate the Mount bracket in the LOCK direction while holding small holes on the Mount bracket.
- ❹ Fix the Mount bracket to the location (ceiling or wall) with supplied three screws.
 - Note :
 - The CAMERA FRONT sign on the Mount bracket should face the camera monitoring area.
- ❺ Extend the wiring up to the ceiling or wall through the bracket.
- ❻ Now attach the Main body to the Mount bracket by rotating it in the LOCK direction after aligning the Groove mark on the Main body with the wide groove around the CAMERA FRONT inlay.
- ❼ Adjust the camera direction. For more details on the direction control, see "Adjusting the camera direction," on the same page. When required to adjust the zoom and focus for your camera, see "Connecting cables and changing the settings," on page 10.
- ❽ Attach the Inner cover to the Main body by pressing it until a "click" sound is heard after aligning two screw holes on the Wing lockers of the Inner cover with two screw holes on the Main body's left and right sides.
- ❾ Finally attach the Cover dome to the Main body by pressing it until a "click" sound is heard after aligning the bump inside the Cover dome with the Groove mark on the Main body.

ENG

Installation

ADJUSTING THE CAMERA DIRECTION

When the camera is fixed on the ceiling, you can adjust the camera viewing angle. You can rotate your camera leftward or rightward (Panning), and can change the slope of your camera upward or downward (Tilting).

In case of panning, the rotation limit of your camera is set to 355 degree (100 degree clockwise and 255 degree counterclockwise). The rotation is stopped by the Stopper inside of the camera. For panning control, first unfasten two screws located on the bottom and rotate in the direction you want, and then fasten them to fix the camera.

In case of tilting, you can change the slope of your camera from zero to 90 degree. However if the slope angle is under 17 degree, you can encounter a partial image hide problem. To fix the location after adjusting the tilting angle, use the Tilt fixing screws.

To adjust the focus and zoom of your camera, use the Zoom lever and Focus lever. When you install the camera on the inclined ceiling or wall, you can rotate the camera lens to see a correct direction image.

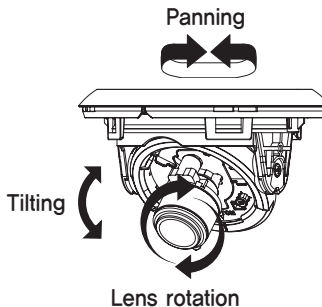

How to use OSD Menu

USING ICONS IN THE MENU

- **☒ (EXIT)**
Exits the menu setting.
Before you exits the menu setting, select SAVE to save your settings, or select QUIT to cancel.
- **↶ (RET)**
Returns to the previous menu.
- **🏠 (HOME)**
Returns to the main menu.
- **☑ (SAVE)**
Used to save your settings of MASK AREA, PRIVACY ZONE and more.
Once you save your settings, they will remain even if you select QUIT in the menu.
- **🗑 (DEL)**
Used to deletes your settings of MASK AREA, PRIVACY ZONE and more.
Once you delete your settings, they will not be restored even if you select QUIT in the menu.

MAIN MENU



- **PROFILE**
You can set a mode according to the camera installation conditions.
- **CAMERA SET**
Configure Camera related functions and data.
- **INTELLIGENCE**
You can configure the settings of motion detection, tracking and more.
- **PRIVACY ZONE**
You can configure the privacy related settings.
- **OTHER SET**
You can configure for Factory Defaults, and more.
- **SYSTEM INFO.**
Displays the system information including the camera version and communication settings.
- **LANGUAGE**
Select a preferred one from the supported languages.

ENG

How to use OSD Menu

PROFILE

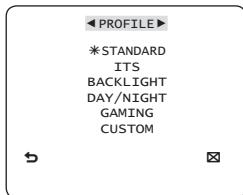

In the **PROFILE** menu, you can configure the following camera settings at once.

CAMERA SET Menu		STANDARD	ITS	BACKLIGHT	DAY/NIGHT	GAMING
Previous Menu	Sub-menus					
VPS		OFF	ON	OFF	OFF	OFF
IRIS		ALC	ALC	ALC	ALC	ALC
	ALC	-	-	-	-	-
	LENS	DC	DC	DC	DC	DC
	LEVEL	0	0	0	0	0
	BACKLIGHT	OFF	OFF	OFF	OFF	OFF
	WDR	-	-	WDR	-	-
	WEIGHT	User setting allowed	User setting allowed	MID	User setting allowed	User setting allowed
	WDR LEVEL	User setting allowed	User setting allowed	0	User setting allowed	User setting allowed
	WHITE BAL	User setting allowed	User setting allowed	User setting allowed	User setting allowed	
MOTION		(F.FAST)---	(F.FAST)---	NORM	(F.FAST)---	SLOW
DNR		MID	MID	MID	MID	MID
SHUTTER		OFF	AUTO1/250	OFF	OFF	OFF
SENS-UP		AUTOx4	AUTOx2	AUTOx4	AUTOx4	AUTOx4

16 – DIGITAL COLOR DOME CAMERA

How to use OSD Menu

CAMERA SET Menu		STANDARD	ITS	BACKLIGHT	DAY/NIGHT	GAMING
Previous Menu	Sub-menus					
XDR		MID	MID	MID	MID	MID
DAY/NIGHT		AUTO	AUTO	DAY	AUTO	DAY
	NIGHT	-	-	-	-	-
WHITE BAL	BURST	OFF	ON	OFF	OFF	OFF
		DAY	DAY/NIGHT	DAY	DAY/NIGHT	DAY
	DAY	-	-	-	-	-
	MODE	ATW2	ATW1	ATW1	ATW1	ATW1
	RED	0	0	0	0	0
	BLUE	0	0	0	0	0
	NIGHT	-	-	-	-	-
	BRIGHTNESS	User setting allowed	MID	User setting allowed	MID	User setting allowed
	MODE	OFF	ATW2	OFF	ATW2	OFF
	RED	User setting allowed	0	User setting allowed	0	User setting allowed
BLUE	User setting allowed	0	User setting allowed	0	User setting allowed	
DETAIL		2	2	2	2	2

ENG

❖ ITS

It will be set automatically so you can easily check the traffic conditions.

❖ BACKLIGHT

It will be set automatically so you can distinguish the object from the background in a severe backlighting scene.

❖ DAY/NIGHT

It will be set automatically so it optimizes to the day or night conditions, respectively.

❖ GAMING

It will be set automatically to help you take a picture in a regular indoor lighting condition.

How to use OSD Menu

CAMERA SETUP

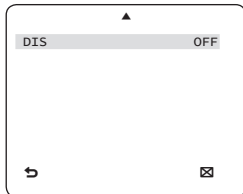
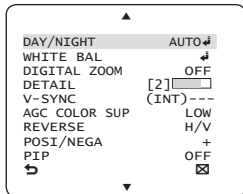
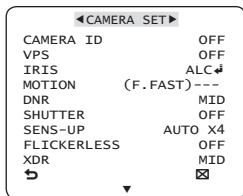

Setup the general functions of zoom camera module.

Use the ▲▼◀▶ switch to select a menu item.

❖ CAMERA ID [OFF, ON]

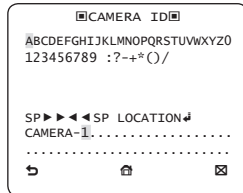

The **CAMERA ID** menu is used for you to assign a unique name to a camera. If you press the **SETUP** switch with the **CAMERA ID** menu selected, you will see the appropriate screen.

You can enter up to 54 alphanumeric or special characters for the **CAMERA ID**. Select **LOCATION** and press the **SETUP** switch to move the display position of the **CAMERA ID**.

❖ VPS [OFF, ON]

If you set the **VPS** (Virtual Progressive Scan) option, the camera will display the image in progressive format.

❖ IRIS [ALC]

The **IRIS** menu is used if you want to adjust the intensity of radiation incoming to the camera.

How to use OSD Menu

• ALC (Automatic Light Control)

- ① If you press the **SETUP** switch with an **ALC**-based sub menu selected, you will see the appropriate screen.

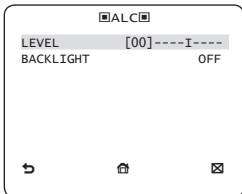

The **LEVEL** menu is used to adjust the overall brightness, where "+" will increase the brightness and "-" will decrease it.

- ② If you set the **BACKLIGHT** option to **BLC**, you will see a menu where you can set the **BLC** area.

you can set the desired **BLC** zone by defining the size and location.

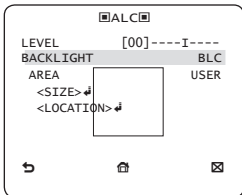

If you use an ordinary camera in a scene with an intensive backlight, the object will be displayed dark on the monitor affected by the backlight. To solve this problem, you can use the **BLC**(Back Light Compensation) function to improve the sharpness of the image in such a high contrast scene.

- ③ If you set the **BACKLIGHT** option to **WDR**, you will see a menu where you can set the WDR options.

You can adjust the shutter speed in **WDR LEVEL** and the brightness in **WEIGHT**.

You can also select any of **OUTDOOR**, and **INDOOR** in **WHITE BAL**.

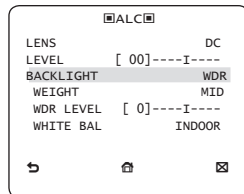

WDR(Wide Dynamic Range) extends the gain range of the screen that is mostly useful if you take a simultaneous picture of both indoor and outside of the window.

Namely, it improves the sharpness of the picture in outdoor scenery as well as indoor.

■ Note :

- If you use the **VPS** (Virtual Progressive Scan) function, the **CCD** reads differently so you can not use **WDR** simultaneously. If you set **VPS** to **ON**, **WDR** will be automatically set to **OFF**.

ENG

How to use OSD Menu

❖ AGC

[OFF, VERY LOW, LOW, MID, HIGH, VERY HIGH, USER, FIX]

The **AGC** (Auto Gain Control) menu is used to set the **AGC** level of the camera. When the **AGC** is active, the camera automatically increases the sensitivity by amplifying the Video signal when the strength of the signal falls below the normal value.

If **OFF** or **FIX** mode is selected in the **SENS-UP** menu, you can specify the **AGC** level.

If you press the **SETUP** switch with a **USER** sub menu selected, you will see the appropriate screen.

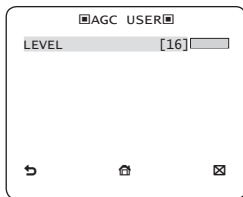

In **USER** mode, you can break down the level in 16 steps from **VERY LOW** to **VERY HIGH** to your preference.

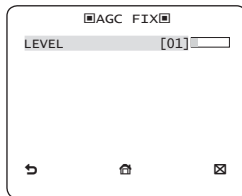

If you press the **SETUP** switch with a **FIX** sub menu selected, you will see the appropriate screen.

As a fixed value of the **AGC** gain is used in **FIX** mode, you can select one of the 16 detailed levels from **VERY LOW** to **VERY HIGH** before fixing it.

FIX mode is not available if you set the **BACKLIGHT** function to **WDR**.

■ Note :

- If the **DAY/NIGHT** menu of the **CAMERA SET** is set to **AUTO**, the **AGC** menu will be deactivated.
- If **FLICKERLESS** is set to **ON**, the **AGC FIX** mode will be disabled.

❖ MOTION [S.SLOW, SLOW, NORM, FAST, F.FAST]

The **MOTION** menu is used to adjust the strength of the **AGC** level for a control of the camera motion. This is available only if the **SENS-UP** menu is set to **AUTO**.

You can select one from **S.SLOW**, **SLOW**, **NORM**, **FAST** and **F.FAST** for the **AGC** level.

If you monitor a fast moving object in a low contrast scene, select **F.FAST** while select **S.SLOW** for a hardly moving object in the same lighting condition.

How to use OSD Menu

■ Note :

- If the **DAY/NIGHT** menu of the **CAMERA SET** is set to **AUTO**, the **MOTION** menu will be deactivated.

❖ **DNR** [OFF,LOW,MID,HIGH, USER(1~16)]

You can configure the **DNR** (Digital Noise Reduction) related settings.

Reduces the noise on the screen.
This is especially useful for a severely distorted screen.

You can set the level if you set **DNR** to **USER**.

❖ **SHUTTER**

[OFF, AUTO 1/100(PAL:1/120), AUTO 1/250, AUTO 1/500, AUTO 1/1000, AUTO 1/2000, AUTO 1/4000, AUTO 1/10K, 1/100(PAL:1/120), 1/250, 1/500, 1/1000, 1/2000, 1/4000, 1/10K]

The **SHUTTER** menu is used to configure settings of the fixed / auto high-speed electronic shutter.

You can select one of 7 options from 1/100(PAL:1/120) to 1/10K for the fixed high speed electronic shutter, which is mostly used for imaging a fast moving object.

The auto high speed electronic shutter operates as the fixed high speed shutter in a high contrast scene but automatically focuses the target if the iris opens fully in a low contrast scene like in **ELC** mode. When it gets brighter back, the mode will switch to the fixed high speed electronic shutter mode.

However, the auto high speed shutter operates properly only in a camera featuring a DC or VIDEO lens.

■ Note :

- If the **SENS-UP** function is set to **AUTO**, only items of **OFF** and **AUTO** are available in the **SHUTTER** menu.
- If the **SENS-UP** mode is set to **FIX**, the **SHUTTER** menu will be deactivated.
- If the **FLICKERLESS** function is set to **ON**, the **SHUTTER** menu will be deactivated.

❖ **SENS-UP**

[OFF, AUTO X2, AUTO X4, AUTO X6, AUTO X8, AUTO X12, AUTO X16, AUTO X24, AUTO X32, AUTO X48, AUTO X64, AUTO X96, AUTO X128, AUTO X256, AUTO X512, FIX X2, FIX X4, FIX X6, FIX X8, FIX X12, FIX X16, FIX X24, FIX X32, FIX X48, FIX X64, FIX X96, FIX X128, FIX X256, FIX X512]

Automatically detects the ambient level of darkness in the dark or low contrast scene to extend the accumulated time, keeping the image bright and sharp; it can be also used as **FIX** mode.

■ Note :

- If the **SHUTTER** menu is set to fixed electronic shutter mode, the **SENS-UP** menu will not be available.
- If **FLICKERLESS** is set to **ON**, the **FIX** mode of the **SENS-UP** menu will be disabled.
- If the **SHUTTER** menu is set to **AUTO**, the **SENS-UP** menu can be set to either **OFF** or **AUTO** mode.
- If the **BACKLIGHT** function is set to **WDR**, the **SENS-UP** menu can not be set to **FIX**.

How to use OSD Menu

❖ FLICKERLESS [OFF, ON]

If set to **ON**, the shutter speed will be fixed to 1/100(PAL:1/120) second. This will prevent possible screen distortion due to a mismatch between the vertical sync frequency and the blinking frequency of the lighting.

▪ Note :

- If the SHUTTER menu is set to AUTO or FIX mode, the FLICKERLESS menu will not be available.
- If the SENS-UP function is set to FIX mode, the Flickerless menu will be deactivated.
- If AGC is set to FIX mode, the FLICKERLESS function will be disabled.

❖ XDR (eXtended Dynamic Range)

[OFF, LOW, MID, HIGH]

Actively controls the gamma compensation in the way it operates the ambient luminance contrast in a certain pixel unit to determine the optimal visibility.

Select one from **OFF, LOW, MID** and **HIGH**. Closing to **HIGH** will increase the compensation level.

❖ DAY/NIGHT [DAY,NIGHT,AUTO,EXT]

• DAY

If set to **DAY**, it will be fixed to **DAY** mode regardless of the ambient conditions.

• NIGHT

If set to **NIGHT**, it will be fixed to Black-and-White mode regardless of the ambient conditions.

If you press the **SETUP** switch with a **NIGHT** sub menu selected, you will see a menu where you can set Burst to **OFF/ON**.

If **BURST** is set to **ON**, the Burst signal will output together with the black-and-white composite video signal. If **BURST** is set to **OFF**, the Burst signal does not output.

You can set the **BURST** option to **OFF/ON**, or select to output the Burst signal in **NIGHT** mode.

• AUTO

The camera will automatically switch between **DAY** and **NIGHT** mode, according to the lighting condition.

If you press the **SETUP** switch with an **AUTO**-based sub menu selected, you will see the appropriate screen.

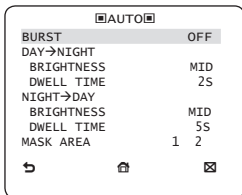

You can set the **BURST** option to **OFF/ON**, or select to output the Burst signal in **NIGHT** mode.

The **BRIGHTNESS** of **DAY→NIGHT** sets the brightness degree of color to BW switching, for which you can select from **LOW, MID**, and

How to use OSD Menu

HIGH. As you adjust it from **HIGH** to **LOW**, the screen switches to black and white mode under the darker situation.

DWELL TIME of DAY→NIGHT sets the time to maintain switched black and white mode.

The **BRIGHTNESS of NIGHT→DAY** sets the brightness degree of BW to color switching, for which you can select from **LOW**, **MID**, and **HIGH**. As you adjust it from **HIGH** to **LOW**, the screen switches to color mode under the darker situation.

DWELL TIME of NIGHT→DAY sets the time to maintain switched color mode.

The **MASK AREA** menu is used to prevent unintended mode switching or inability of determining the switching due to existence of high spot light source at night.

If you press the **SETUP** switch in item 1 or 2 of the **MASK AREA** menu, you will see a menu where you can specify an area to **MASK**.

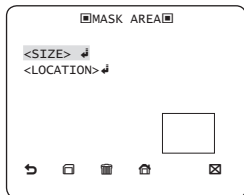

You can specify MASK 1 and 2 simultaneously.

The MASK is only for determining the mode switching, and any excessive bright area at night will be excluded by the configured MASK.

■ **Note :**

- If **BACKLIGHT** is set to **BLC**, the **MASK AREA** function will be deactivated.

• **EXT**

This enables an auto switch between **DAY** and **NIGHT** mode using the interface with the external sensor.

❖ **WHITE BAL [DAY/NIGHT]**

If you want to adjust the color scheme, use the **WHITE BALANCE** function.

• **DAY**

In **DAY** mode, you can set the color values of **RED** and **BLUE**. The screen will be displayed in colors according to your settings.

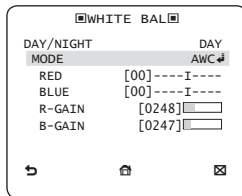

■ **Note :**

- You can set the values of **R-GAIN** and **B-GAIN** only in **AWC** mode.

ENG

How to use OSD Menu

• NIGHT

Use the **NIGHT** mode if you want to set the white balance differently according to the ambient luminance.

If the **NIGHT** mode is set to **OFF**, the white balance will always operate as set in **DAY** mode; if not to **OFF**, the camera will switch to as set in **DAY/NIGHT** mode according to the brightness.

In **NIGHT** mode, you can set the values of **RED**, **BLUE** and **BRIGHTNESS**. The screen will be displayed in colors according to your settings.

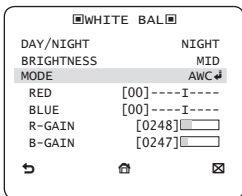

■ Note :

- You can set the values of **R-GAIN** and **B-GAIN** only in **AWC** mode.
- If **AGC** is set to **OFF** or **FIX**, you can not access the **NIGHT** menu.

– For adjusting the white balance, the following 5 modes are provided:

- **ATW1**(Auto Tracing White Balance mode 1): The camera can automatically adjust the color temperature in real time, according to

the ambient conditions. The color temperature ranges from approx. 2500K to 9300K.

- **ATW2**: The color temperature ranges from approx. 2,000K to 10,000K.
- **AWC** (Auto White Balance Control): If you press the **SETUP** switch in the appropriate item position, Auto White Balance will perform once.
- **3200K** : Set color temperature to 3200K
- **5600K** : Set color temperature to 5600K
- **RED** : Adjusts the strength of the red color.
- **BLUE** : Adjusts the strength of the blue color.
- **R-GAIN/B-GAIN** : Enables you to set the current color temperature manually.
- **BRIGHTNESS** : Select a brightness level in switching from setting in **DAY** mode to setting in **NIGHT** mode.

❖ DIGITAL ZOOM [ON/OFF]

You can set the digital zoom factor and position. If you press the **SETUP** switch with the **DIGITAL ZOOM** function set to **ON**, you will see the appropriate screen.

When the zoom factor and position are defined, the digital zoom function will operate.

How to use OSD Menu

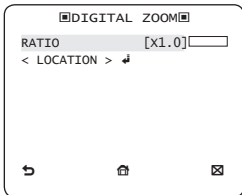

- **LOCATION** : If you press the **SETUP** switch in the condition where the image is enlarged as much as the ratio setting, you can watch an invisible area of the effective screen as well using the **▲▼▶◀** switch.

■ **Note** :

- If the digital zoom factor is set to larger than 1x, the **FENCE** function will be deactivated.
The **DIGITAL ZOOM** function enlarges the pixel itself, which can cause deterioration of the quality.

❖ **DETAIL** [0~3]

Controls the horizontal or vertical distinction.

❖ **V-SYNC** [INT, LINE]

Select the vertical sync mode for **INT** or **LINE**.

If you select **INT**, the camera will use the internal synchronization.

If selecting **LINE**, the camera will use the external power source frequency for the synchronization.

You can adjust the **LL-PHASE**.

■ **Note** :

- Use of DC 12V will fix **V-SYNC** to **INT**, which can not be changed.

❖ **AGC COLOR SUP** [LOW , MID, HIGH]

Adjust the color scheme according to the **AGC** value.

❖ **REVERSE** [OFF, H, V, H/V]

Mirrors video signals horizontally, vertically, or both.

❖ **POSI/NEGA** [+ , -]

Output as it is or mirror the video brightness signal.

❖ **PIP** [OFF, ON]

Displays a sub image together with the main image on the same screen using the Picture In Picture function.

■ **Note** :

- If more than one privacy zone is set and the **PRIVACY SET** is set to **ON**, the **PIP** function will be deactivated.
- If the **INTELLIGENCE** function is set to **FENCE** mode, the **PIP** menu will be deactivated.

❖ **DIS** [OFF, ON]

Digital Image Stabilization will set the anti-shake compensation.

■ **Note** :

- If you set **DIS** to **ON**, the compensation area will be enlarged as set in the digital zoom factor.
If you set the digital zoom factor to greater than the enlarged zoom factor for the compensation, the **DIS** function will be deactivated.

How to use OSD Menu

INTELLIGENCE

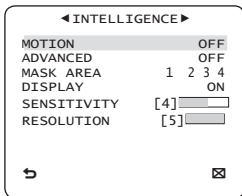

You can set the motion detection and tracking in the **INTELLIGENCE** menu.

❖ MOTION [OFF, TRACKING, DETECTION]

• TRACKING

Detects and tracks a moving object.

• DETECTION

Detects a moving object.

▪ Note :

– If it is set to **DETECTION**, you can not set such functions as **FIXED/MOVED** and **FENCE** in the **ADVANCED** menu.

❖ ADVANCED [OFF, FIXED/MOVED, FENCE]

Detects a motion of an object and displays an image of any moving object before tracking the moving route.

• FENCE

This is to detect if a moving object passes through the specified **LINE** or **AREA**.

In a condition where a moving object is detected in an analysis of the previous and current frames whose movement overlaps a certain area, the system displays "PASS" if the object's center line passes through the line while it displays "ENTER" or "EXIT" if the center point passes through the area.

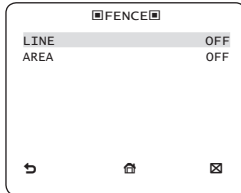

You can set the position and detection direction of the **LINE**, and the size and position of the **AREA**.

- How to set the line

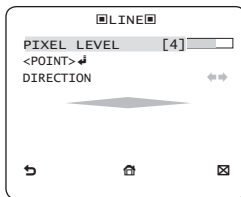

How to use OSD Menu

- ① If you press the **SETUP** switch with the **LINE** option set to **ON**, you can specify the position and detection direction of the line.
 - ② If you change the **PIXEL LEVEL** for setting the position, specify the pixel that moves by a single pressure of the **▲▼◀▶** switch.
 - ③ In **<POINT>**, you can specify the first position of the line by pressing the **SETUP** switch once, and the second position by pressing the switch again. Use the **▲▼◀▶** switch to specify the position. Set each position of the two points and press the **SETUP** switch to complete the positioning.
 - ④ If you change the **DIRECTION**, you can specify the detection direction. The detection direction based on the defined two points will be displayed on the screen.
- ② If you change the **PIXEL LEVEL** for setting the position, specify the pixel that moves by a single pressure of the **▲▼◀▶** switch.
 - ③ In **<SIZE>**, press the **SETUP** switch and use the **▲▼◀▶** switch to adjust the size. Press the **SETUP** switch again to complete the sizing.
 - ④ In **<LOCATION>**, press the **SETUP** switch and use the **▲▼◀▶** switch to specify the position. Press the **SETUP** switch again to complete the positioning.

■ Note :

- If you set the **LINE** of the **FENCE** to **ON**, **PRIVACY 12** will not be available. Functions of **FENCE**, **PIP**, **DIS** and **DIGITAL ZOOM** (if the digital zoom factor is set to larger than 1x) can not be used simultaneously.
- In the boundary of the defined **AREA** and **LINE**, a **FENCE** detection error may occur if two or more moving objects overlap with each other or one object separates in multiple directions.

• FIXED/MOVED

If an object on the screen suddenly disappears or an object comes out of nowhere and stays for a certain time, the area will be displayed.

A detection (**FIXED/MOVED**) error may occur if :

- multiple motions occur continuously in random directions
- a fixed object moves in one position continuously
- a second object screens the first moving object

- How to set the area

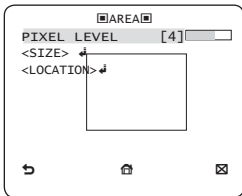

- ① If you press the **SETUP** switch with the **AREA** option set to **ON**, you can specify the position and size of the area.

ENG

English - 27

How to use OSD Menu

❖ MASK AREA [1~4]

Specify a detection exception area to mask.

Select a mask number and specify the size and position.

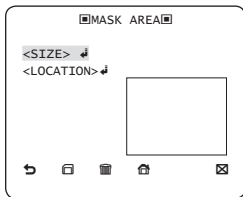

❖ DISPLAY [ON, OFF]

With the **DISPLAY** option set to **ON**, a motion or a set **ADVANCED** function will be displayed on the screen, if detected.

❖ SENSITIVITY [1~7]

Set the sensitivity of the motion detection.

❖ RESOLUTION [1~5]

If setting it to high, the camera can detect even a trivial movement of the target.

PRIVACY ZONE SETUP

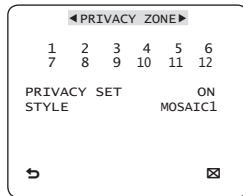

The **PRIVACY** function will protect your privacy by screening the privacy area that you have specified during monitoring. You can specify up to 12 privacy zones.

If you set the **PRIVACY SET** to **ON**, your **PRIVACY ZONE** settings will be applied.

You can change the style to adjust the mosaic size and color of the **PRIVACY ZONE**.

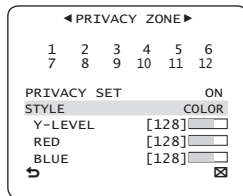

How to use OSD Menu

Use the ▲▼◀▶ switch to select one from **PRIVACY 1** through 12.

Select one from **PRIVACY 1-12** and press the **SETUP** switch to confirm your setting. You can specify a pixel that moves as you change the **PIXEL LEVEL** to set the position.

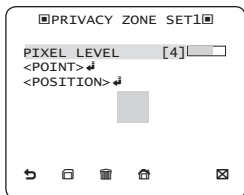

- How to set the point

You can set each position of the 4 points.

- ① If you press the **SETUP** switch in **<POINT>**, you will see the points available in the **PRIVACY ZONE**. Each time you press the **SETUP** switch, the points available will move.
- ② Use the ▲▼◀▶ switch to set the position of each point. Set each position of the four points and press the **SETUP** switch to complete the positioning.

- How to set the position

You can move the position of the overall area.

- ① By pressing the **SETUP** switch in **<POSITION>**, you can move the overall position of the privacy zone.
- ② Use the ▲▼◀▶ switch to move the position and press the **SETUP** switch to confirm it.

■ Note :

- If more than one **PRIVACY ZONE** is specified and the **PRIVACY SET** is set to **ON**, the **PIP** function will be deactivated.
- If the 12th **PRIVACY ZONE** is specified, the **LINE** function of **FENCE** will be deactivated.

ENG

How to use OSD Menu

OTHER SET

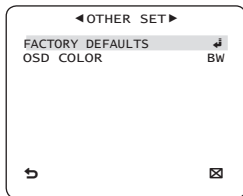

❖ FACTORY DEFAULTS

All the settings will be restored to the factory default.

However, the settings of **PROTOCOL**, **BAUD RATE**, **ADDRESS** and **LANGUAGE** will not be restored to the default.

❖ OSD COLOR [BW, R/G/B]

You can set the OSD(On-screen Display) color to COLOR or B/W.

SYSTEM INFORMATION

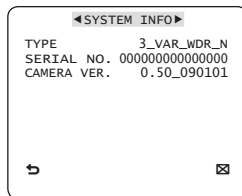

You can check the system information such as SERIAL NO and CAMERA VER.

LANGUAGE

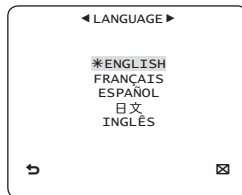

The camera supports 5 different languages.
Select a preferred language.

How to use OSD Menu

◆ Initial Configuration Table

• Camera Configuration	
CAMERA ID	OFF
VPS	OFF
IRIS	ALC
AGC	VERY HIGH
MOTION	(F.FAST)
DNR	MID
SHUTTER	OFF
SENS-UP	AUTO x4
FLICKERLESS	(OFF)
XDR	MID
DAY/NIGHT	AUTO
DIGITAL ZOOM	OFF
DETAIL	[2]
AGC COLOR SUP	MID
REVERSE	H/V
POSI/NEGA	+
PIP	OFF
DIS	OFF
V-SYNC	INT

ENG

Specifications

SPECIFICATIONS

Items	Sub-items	SCC-B5367N/SCC-B5367SN/SCC-B5369N/SCC-B5369SN					
Camera Type	CCTV Camera (WDR & DAY/NIGHT)						
Image	Device		1/3" Super-HAD PS CCD				
	Pixels	Total	811 x 508				
		Effective	768 x 494				
Scanning	System	Interlace/Progressive					
	Scanning Line	525 lines					
	Frame	30frame/1sec					
	Horizontal Frequency	Internal Mode	15,734 Hz				
		Line-lock Mode	15,750 Hz				
	Vertical Frequency	Internal Mode	59.94 Hz				
Line-lock Mode		60 Hz					
Min. Scene Illumination	Condition			Min. Scene Illumination			
	Sens-up	F.No.	Level	DAY	NIGHT		
	OFF	1.2	50 IRE	0.4 Lux	0.04	Lux	
	OFF	1.2	30 IRE	0.24 Lux	0.024	Lux	
	OFF	1.2	15 IRE	0.12 Lux	0.012	Lux	
	512 times	1.2	50 IRE	0.0008 Lux	0.00008	Lux	
	512 times	1.2	30 IRE	0.00047 Lux	0.000047	Lux	
	512 times	1.2	15 IRE	0.00023 Lux	0.000023	Lux	
Functions	Number of Privacy Zone		12 (Polygonal Method)				
	Day/Night		DAY/NIGHT/AUTO/EXT				
	Motion Detection		Off/Tracking/Detection				
	eXtended Dynamic Range(XDR)		Off/On (Level Setting)				
	Wide Dynamic Range(WDR)		Off/On (x128)				
	Virtual Progressive Scan(VPS)		Off/On				
	D-Zoom		x1 ~ x16 (x0.1 STEP)				
	PIP		Off/On				
	High Speed Shutter		1/60 ~ 1/10Ksec (OSD)				
Flickerless		Off/On					

32 – DIGITAL COLOR DOME CAMERA

Specifications

Items	Sub-items	SCC-B5367N/SCC-B5367SN/SCC-B5369N/SCC-B5369SN
	Sens-Up	x2 ~ x512
	AGC	Off/On (Max.Level Setting)
	Line Lock	Off/On (Phase Control)
	Camera ID	Off/On (Max.54ea/2Line)
	White Balance	ATW1/ATW2/AWC/3200K/5600K
	Digital Noise Reduction(DNR)	Off/On (Adaptive 3D+2D)
	Digital Image Stabilization(DIS)	Off/On
	Intelligent Video	Fixed/Moved, Fence
Resolution	Etc. Function	Detail, Reverse(H/V), Posi/Nega
	Horizontal	600 TV Lines
Video Output	Vertical	350 TV Lines
	-	VBS 1.0Vp-p, 75 Ω
S/N Ratio	S/N Ratio	Approx. 52dB
Lens	Lens Drive Type	Auto Iris (DC) SCC-B5367 : focal length = 2.5 to 6.0mm / Aperture ratio = F 1.2 SCC-B5369 : focal length = 2.8 to 11.0mm / Aperture ratio = F 1.2
PAN	Range	0 ~ 355°(100° in CW(Clockwise) direction, 255° in CCW (Counterclockwise) direction)
TILT	Range	0 ~ 90°
Remote Control	Coaxitron (Data On Coax cable)	Yes (with SCX-RD100)
Environmental Conditions	Operating Temperature	-10°C ~ +50°C
	Humidity	Less than 90%
Power	Power Requirement	AC24V ± 10%(60Hz ± 0.3Hz) DC12V ± 10%
	Power Consumption	about 2.6W
Physical Specification	Dimensions (Ø x H)	128(Ø) x 91(H)mm
	Weight	330g
	Color	SCC-B5367/SCC-B5369 : White SCC-B5367S/SCC-B5369S : Silver

ENG

Specifications

Items	Sub-items	SCC-B5367P/SCC-B5367SP/SCC-B5369P/SCC-B5369SP					
Camera Type	CCTV Camera (WDR & DAY/NIGHT)						
Image	Device		1/3" Super-HAD PS CCD				
	Pixels	Total	795 x 596				
		Effective	752 x 582				
Scanning	System		Interlace/Progressive				
	Scanning Line		625 lines				
	Frame		25frame/1sec				
	Horizontal Frequency	Internal Mode	15,625 Hz				
		Line-lock Mode	15,625 Hz				
	Vertical Frequency	Internal Mode	50 Hz				
		Line-lock Mode	50 Hz				
Min. Scene Illumination	Condition			Min. Scene Illumination			
	Sens-Up	F.No.	Level	DAY	NIGHT		
	OFF	1.2 50	IRE	0.4 Lux	0.04 Lux		
	OFF	1.2 30	IRE	0.24 Lux	0.024 Lux		
	OFF	1.2 15	IRE	0.12 Lux	0.012 Lux		
	512 times	1.2 50	IRE	0.0008 Lux	0.00008 Lux		
	512 times	1.2 30	IRE	0.00047 Lux	0.000047 Lux		
	512 times	1.2 15	IRE	0.00023 Lux	0.000023 Lux		
Functions	Number of Privacy Zone		12 (Polygonal Method)				
	Day/Night		DAY/NIGHT/AUTO/EXT				
	Motion Detection		Off/Tracking/Detection				
	eXtended Dynamic Range(XDR)		Off/On (Level Setting)				
	Wide Dynamic Range(WDR)		Off/On (x160)				
	Virtual Progressive Scan(VPS)		Off/On				
	D-Zoom		Max. x16				
	PIP		Off/On				
	High Speed Shutter		1/50 ~ 1/10Ksec (OSD)				
	Flickerless		Off/On				
	Sens-Up		x2 ~ x512				
	BLC		Off/On (Area Setting)				

34 – DIGITAL COLOR DOME CAMERA

Specifications

Items	Sub-items	SCC-B5367P/SCC-B5367SP/SCC-B5369P/SCC-B5369SP
	AGC	Off/On (Max.Level Setting)
	Line Lock	Off/On (Phase Control)
	Camera ID	Off/On (Max.54ea/2Line)
	White Balance	ATW1/ATW2/AWC/3200K/5600K
	Digital Noise Reduction(DNR)	Off/On (Adaptive 3D+2D)
	Digital Image Stabilization(DIS)	Off/On
	Intelligent Video	Fixed/Moved, Fence
	Etc. Function	Detail, Reverse(H/V), Posi/Nega
Resolution	Horizontal	600 TV Lines
	Vertical	350 TV Lines
Video Output	-	VBS 1.0Vp-p, 75 Ω
S/N Ratio	S/N Ratio	Approx. 52dB
Lens	Lens Drive Type	Auto Iris (DC)
		SCC-B5367 : focal length = 2.5 to 6.0mm / Aperture ratio = F 1.2 SCC-B5369 : focal length = 2.8 to 11.0mm / Aperture ratio = F 1.2
PAN	Range	0 ~ 355°(100° in CW(Clockwise) direction, 255° in CCW (Counterclockwise) direction)
TILT	Range	0 ~ 90°
Remote Control	Coaxitron (Data On Coax cable)	Yes (with SCX-RD100)
Environmental Conditions	Operating Temperature	-10°C ~ +50°C
	Humidity	Less than 90%
Power	Power Requirement	AC24V ± 10%(50Hz±0.3Hz) DC12V ± 10%
	Power Consumption	about 2.6W
Physical Specification	Dimensions (Ø x H)	128(Ø) x 91(H)mm
	Weight	330g
	Color	SCC-B5367/SCC-B5369 : White
		SCC-B5367S/SCC-B5369S : Silver

ENG



Free Manuals Download Website

<http://myh66.com>

<http://usermanuals.us>

<http://www.somanuals.com>

<http://www.4manuals.cc>

<http://www.manual-lib.com>

<http://www.404manual.com>

<http://www.luxmanual.com>

<http://aubethermostatmanual.com>

Golf course search by state

<http://golfingnear.com>

Email search by domain

<http://emailbydomain.com>

Auto manuals search

<http://auto.somanuals.com>

TV manuals search

<http://tv.somanuals.com>