

SCC-B5396

SCC-B5398

DIGITAL COLOR DOME CAMERA

user manual

ENG

FRE

GER

SPA

ITA

imagine the possibilities

Thank you for purchasing this Samsung product.
To receive more complete service,
please register your product at
www.samsungsecurity.com



Safety information



CAUTION

RISK OF ELECTRIC SHOCK.
DO NOT OPEN



CAUTION: TO REDUCE THE RISK OF ELECTRIC SHOCK, DO NOT REMOVE COVER (OR BACK) NO USER SERVICEABLE PARTS INSIDE. REFER SERVICING TO QUALIFIED SERVICE PERSONNEL.



This symbol indicates that dangerous voltage consisting a risk of electric shock is present within this unit.



This exclamation point symbol is intended to alert the user to the presence of important operating and maintenance (servicing) instructions in the literature accompanying the appliance.

WARNING

- To prevent damage which may result in fire or electric shock hazard, do not expose this appliance to rain or moisture.

WARNING

1. Be sure to use only the standard adapter that is specified in the specification sheet. Using any other adapter could cause fire, electrical shock, or damage to the product
2. Incorrectly connecting the power supply or replacing battery may cause explosion, fire, electric shock, or damage to the product.
3. Do not connect multiple cameras to a single adapter. Exceeding the capacity may cause abnormal heat generation or fire.
4. Securely plug the power cord into the power receptacle. Insecure connection may cause fire.
5. When installing the camera, fasten it securely and firmly. A falling camera may cause personal injury.
6. Do not place conductive objects (e.g. screwdrivers, coins, metal things, etc.) or containers filled with water on top of the camera. Doing so may cause personal injury due to fire, electric shock, or falling objects.
7. Do not install the unit in humid, dusty, or sooty locations. Doing so may cause fire or electric shock.

2 – DIGITAL COLOR DOME CAMERA

Safety information

8. If any unusual smells or smoke come from the unit, stop using the product. In such case, immediately disconnect the power source and contact the service center. Continued use in such a condition may cause fire or electric shock.
9. If this product fails to operate normally, contact the nearest service center. Never disassemble or modify this product in any way. (SAMSUNG is not liable for problems caused by unauthorized modifications or attempted repair.)
10. When cleaning, do not spray water directly onto parts of the product. Doing so may cause fire or electric shock.

CAUTION

1. Do not drop objects on the product or apply strong shock to it. Keep away from a location subject to excessive vibration or magnetic interference.
2. Do not install in a location subject to high temperature (over 50°C), low temperature (below -10°C), or high humidity. Doing so may cause fire or electric shock.
3. If you want to relocate the already installed product, be sure to turn off the power and then move or reinstall it.
4. Remove the power plug from the outlet when there is a lightning. Neglecting to do so may cause fire or damage to the product.
5. Keep out of direct sunlight and heat radiation sources. It may cause fire.
6. Install it in a place with good ventilation.
7. Avoid aiming the camera directly towards extremely bright objects such as sun, as this may damage the CCD image sensor.
8. Apparatus shall not be exposed to dripping or splashing and no objects filled with liquids, such as vases, shall be placed on the apparatus.
9. The Mains plug is used as a disconnect device and shall stay readily operable at any time.

ENG

Important Safety Instructions

WARNING

1. Read these instructions.
2. Keep these instructions.
3. Heed all warnings.
4. Follow all instructions.
5. Do not use this apparatus near water.
6. Clean only with dry cloth.
7. Do not block any ventilation openings. Install in accordance with the manufacturer's instructions.
8. Do not install near any heat sources such as radiators, heat registers, or other apparatus (including amplifiers) that produce heat.
9. Do not defeat the safety purpose of the polarized or grounding-type plug. A polarized plug has two blades with one wider than the other. A grounding type plug has two blades and a third grounding prong. The wide blade or the third prong is provided for your safety. If the provided plug does not fit into your outlet, consult an electrician for replacement of the obsolete outlet.
10. Protect the power cord from being walked on or pinched particularly at plugs, convenience receptacles, and the point where they exit from the apparatus.
11. Only use attachments/accessories specified by the manufacturer.
12. Use only with cart, stand, tripod, bracket, or table specified by the manufacturer, or sold with the apparatus.
13. Unplug this apparatus when a card is used. Use caution when moving the cart/apparatus combination to avoid injury from tip-over.
14. Refer all servicing to qualified service personnel. Servicing is required when the apparatus has been damaged in any way, such as power supply cord or plug is damaged, liquid has been spilled or objects have fallen into the apparatus, the apparatus has been exposed to rain or moisture, does not operate normally, or has been dropped.



4 – DIGITAL COLOR DOME CAMERA

Contents

Introduction

Features	6
Product & Accessories	7
Part Names and Functions	8

Installation

Installation procedure	11
Adjusting the camera direction	12

How to use OSD Menu

Using Icons in the Menu	14
Main Menu	14
Profile	15
Camera Setup	17
Intelligence	24
Privacy Zone Setup	27
Other Set	28
System Information	29
Language	29

Specifications

Specifications	30
----------------	----

ENG

Introduction

FEATURES

❖ High Resolution

- This camera has realized high resolution of 600 lines using the top-notch full digital image processing and special algorithm technologies.

❖ Intelligent Motion Detection & Tracking

- This is an intelligent function that automatically detects a motion of an object. You can set a virtual fence so it displays an alert if an object passes / enters / exits the virtual fence or virtual area.

❖ XDR (eXtended Dynamic Range)

- Actively controls the gamma compensation in the way it operates the ambient luminance contrast in a certain pixel unit to determine the optimal visibility.

❖ High Sensitivity

- It implements images of high sensitivity using the up-to-date SONY Super-HAD IT CCD..

❖ Low Illumination

- It uses the digital signal technologies such as low illumination and Day/Night functions that make your camera identify objects even in the worst environment.

❖ Superior Backlight Adjustment

- When an object has a bright illumination or sunlight behind it, this camera automatically improves the shaded object picture quality.

❖ Digital Power Synchronization

- The full digital Line Lock function directly adjusts the vertical camera synchronization to enhance the operability and reliability of this camera.

❖ Output Signal Setting

- You can set the following Video output signals: Image reversion (Horizontal, Vertical, or both), Privacy, Horizontal/Vertical profiling, and digital zooming.

❖ OSD(On Screen Display) Menu

- OSD menu is provided to display the status of camera and to configure the functions interactively.

❖ Coaxial Cable Communication

- This is a remote control function that overlaps the coaxial cable (for a transfer of the video signal) with the control signal. In installation or repair, this helps you control the communication controller (optional) without additional cabling.

Introduction

Components

Checking components in the package



Camera



Test Monitor Cable



User's Guide

Image	Part name	Standard	Quantity	Usage
	Plastic anchor	HUD 5	4 (EA)	Attach each piece to screw connection holes for strengthening connection
	ASSY screw machine	BH M5 X L6. (White+o-ring)	8	Used for filling in the holes when installing pipe and wall mount
	ASSY screw tapping	TH M4xL30 (Black+o-ring)	4	Used when installing your camera on the ceiling or wall.
	L-Wrench	TROX T-20	1	Used for assembling/disassembling the Dome cover
	Template		1	Used for guiding the installation
	Gasket-pipe hole	T2.5 W56	1	Used to make a wiring hole when installing the camera on the ceiling or wall

- NOTE

- The test monitor cable is used to test the camera by connecting to a portable display. If you really want to connect the camera to a monitoring display, use the BNC cable. .

ENG

English - 7

Introduction

Components of your camera

Your camera has the following components:

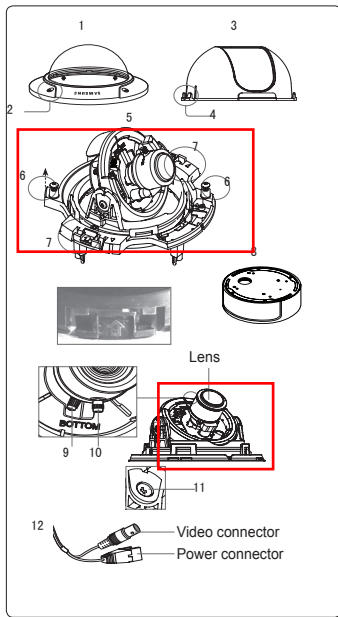

8 – DIGITAL COLOR DOME CAMERA

1. Dome cover: Covers the inner cover, lens, and main body to protect them.
2. Cover screw: Use it to assemble or disassemble both dome cover and case.
3. Inner cover: Covers the main body to protect it.
4. Wing locker: Push a long thin screwdriver into its narrow spot and press it outward when you want to remove the inner cover.
5. Main body: Includes a lens, a switch board, a PCB board, screws, and such.
6. Screws for assembly and disassembly: Using these 2 screws, the Main body is closely connected to the Case.
7. Hooker: By pulling the left/right levers in the arrow direction, the Main body can be detached from the Case.
8. Case: Used as a ceiling or wall fixture. It is fixed using four screws provided in the package.
9. Zoom lever: Using this lever, the lens zoom can be adjusted and fixed.
10. Focus lever: Using this lever, the lens focus can be adjusted and fixed.
11. Tilt fixing screw: Using this screw, the slope of the lens can be adjusted and fixed.
12. Cable: Connect the Video connector to BNC cable and Power connector to power adapter.

❖ Setting switches

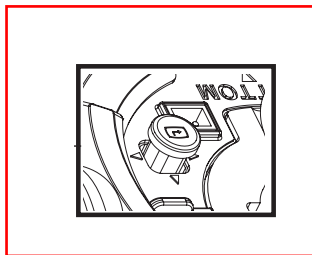

ENG

• SETUP Switch

This switch is used to set the function or property. When this switch is pressed for at least 2 seconds, the MAIN MENU appears.

- ◀ ▶ **(Left/Right)** : By pressing this switch left or right, you can move left or right on the menu or change the displayed value.
- ▲ ▼ **(Up/Down)** : By pressing this switch up or down, you can move up or down on the menu.
- ▣ : When you press this switch in the menu, the selected function is confirmed. To enter a submenu, press this button..

Installing camera

Before installation

Before installing your camera, you have to read the following cautions:

- You have to check whether the location (ceiling or wall) can bear five times the weight of your camera.
- Don't let the cable to be caught in improper place or the electric line cover to be damaged. Otherwise it may cause a breakdown or fire. You can use wall mount adaptor (SADT-102WM), and pole mount adaptor (SADT-100PM) for installing the camera on the wall or pipeline.
- When installing your camera, don't allow any person to approach the installation site. If you have any valuable things under the place, move them away.

About the installation holes

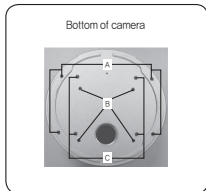

A: Use these holes when directly installing your camera on the ceiling or wall.

× While those are not used, fill in the holes using the screw machine (M5 X L6.) for waterproofing.

B: Use four holes when directly installing your camera on the junction box
× You can use the 4 1/8 diameter round type junction box for assembly.
(The junction box, gasket, and cover are separately purchased items.)

C: Use these holes when installing the wall mount adaptor (SADT-102WM)

× While those are not used, fill in the holes using the screw machine (M5 X L6.) for waterproofing.

The holes that are not used should be tightly sealed up using the screws provided for waterproofing. When the screws don't have rubber rings inside or are not closely attached, note that it can cause waterproofing problem.
For attaching screws, see page 16
Disassembling/assembling the Main body from the Case.

Installing on a pipe

Before installation, you have to be familiar with the above cautions and fill in the holes that are not used for installation.

To install your camera bottom on a pipe

1. After connecting the power and video cables, throw them inside the pipeline and screw the male thread pipe into the female pipe and screw the thread pipe into the female pipe and screw the male thread pipe into the female pipe thread in your camera tightly to fix the **Main body**. (In this case, be sure to tape with Teflon tape before assembly for waterproofing. Be careful for the wiring cable not to be stuck in the connection area.)



3. Attach the Dome cover. (Screw the connection bolts tightly using the L-Wrench for waterproofing.)
 - × To change the SAMSUNG logo position, move the location of the connection rubber band as show below and rotate for assembly. (The rotation limit is 180 degree.)



2. Adjust the angle of the camera in search of a better view.

- 1) Separate the Dome cover using the L-Wrench provided. (To make loose the screws, rotate counterclockwise.)



- 2) Adjust the lens direction. For more information, see page 17 "Adjusting the camera direction."

Installation

Adjusting the camera direction

When the camera is fixed on the ceiling, you can adjust the camera viewing angle. You can rotate your camera leftward or rightward (Panning), and can change the slope of your camera upward or downward (Tilting).

In case of panning, the rotation limit of your camera is set to 355 degree (100 degree clockwise and 255 degree counterclockwise). The rotation is stopped by the **Stopper** inside of the camera. For panning control, first unfasten two screws located on the bottom and rotate in the direction you want, and then fasten them to fix the camera.

In case of tilting, you can change the slope of your camera from zero to 90 degree. However if the slope angle is under 17 degree, you can encounter a partial image hide problem. To fix the location after adjusting the tilting angle, use the **Tilt fixing screws**.

To adjust the focus and zoom of your camera, use the **Zoom lever** and **Focus lever**. When you install the camera on the inclined ceiling or wall, you can rotate the camera lens to see a correct direction image.

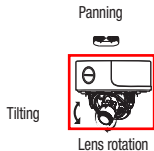

How to use OSD Menu

USING ICONS IN THE MENU

- **EXIT (EXIT)**
Exits the menu setting.
Before you exits the menu setting, select SAVE to save your settings, or select QUIT to cancel.
- **RET (RET)**
Returns to the previous menu.
- **HOME (HOME)**
Returns to the main menu.
- **SAVE (SAVE)**
Used to save your settings of MASK AREA, PRIVACY ZONE and more.
Once you save your settings, they will remain even if you select QUIT in the menu.
- **DEL (DEL)**
Used to deletes your settings of MASK AREA, PRIVACY ZONE and more.
Once you delete your settings, they will not be restored even if you select QUIT in the menu.

MAIN MENU



- **PROFILE**
You can set a mode according to the camera installation conditions.
- **CAMERA SET**
Configure Camera related functions and data.
- **INTELLIGENCE**
You can configure the settings of motion detection, tracking and more.
- **PRIVACY ZONE**
You can configure the privacy related settings.
- **OTHER SET**
You can configure for Factory Defaults, and more.
- **SYSTEM INFO.**
Displays the system information including the camera version and communication settings.
- **LANGUAGE**
Select a preferred one from the supported languages.

ENG

How to use OSD Menu

PROFILE

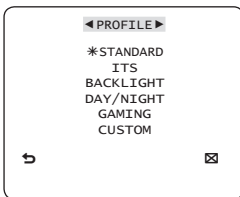

In the **PROFILE** menu, you can configure the following camera settings at once.

CAMERA SET Menu		STANDARD	ITS	BACKLIGHT	DAY/NIGHT	GAMING
Previous Menu	Sub-menus					
IRIS		ALC	ALC	ALC	ALC	ALC
	ALC	-	-	-	-	-
	LENS	DC	DC	DC	DC	DC
	LEVEL	0	0	0	0	0
	BACKLIGHT	OFF	OFF	BLC	OFF	OFF
MOTION		(F.FAST)---	(F.FAST)---	NORM	(F.FAST)---	SLOW
DNR		MID	MID	MID	MID	MID
SHUTTER		OFF	AUTO1/250	OFF	OFF	OFF
SENS-UP		AUTOx4	AUTOx2	AUTOx4	AUTOx4	AUTOx4
XDR		MID	MID	MID	MID	MID
DAY/ NIGHT		AUTO	AUTO	DAY	AUTO	DAY
	NIGHT	-	-	-	-	-
	BURST	OFF	ON	OFF	OFF	OFF

How to use OSD Menu

CAMERA SET Menu		STANDARD	ITS	BACKLIGHT	DAY/NIGHT	GAMING
Previous Menu	Sub-menus					
WHITE BAL		DAY	DAY/NIGHT	DAY	DAY/NIGHT	DAY
	DAY	-	-	-	-	-
	MODE	ATW2	ATW1	ATW1	ATW1	ATW1
	RED	0	0	0	0	0
	BLUE	0	0	0	0	0
	NIGHT	-	-	-	-	-
	BRIGHTNESS	User setting allowed	MID	User setting allowed	MID	User setting allowed
	MODE	OFF	ATW2	OFF	ATW2	OFF
	RED	User setting allowed	0	User setting allowed	0	User setting allowed
	BLUE	User setting allowed	0	User setting allowed	0	User setting allowed
DETAIL		2	2	2	2	2

ENG

❖ ITS

It will be set automatically so you can easily check the traffic conditions.

❖ BACKLIGHT

It will be set automatically so you can distinguish the object from the background in a severe backlighting scene.

❖ DAY/NIGHT

It will be set automatically so it optimizes to the day or night conditions, respectively.

❖ GAMING

It will be set automatically to help you take a picture in a regular indoor lighting condition.

How to use OSD Menu

CAMERA SETUP

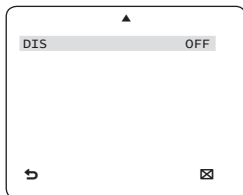
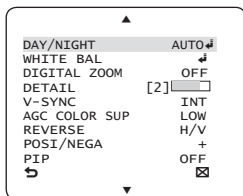
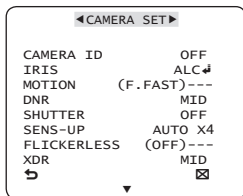

Setup the general functions of zoom camera module.

Use the ▲▼◀▶ switch to select a menu item.

❖ CAMERA ID [OFF, ON]

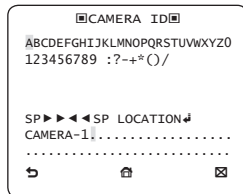

The **CAMERA ID** menu is used for you to assign a unique name to a camera. If you press the **SETUP** switch with the **CAMERA ID** menu selected, you will see the appropriate screen.

You can enter up to 54 alphanumeric or special characters for the **CAMERA ID**. Select **LOCATION** and press the **SETUP** switch to move the display position of the **CAMERA ID**.

❖ IRIS [ALC]

The **IRIS** menu is used if you want to adjust the intensity of radiation incoming to the camera.

• ALC (Automatic Light Control)

- ① If you press the **SETUP** switch with an **ALC**-based sub menu selected, you will see the appropriate screen.

How to use OSD Menu

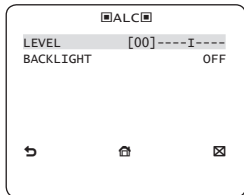

The **LEVEL** menu is used to adjust the overall brightness, where "+" will increase the brightness and "-" will decrease it.

- ② If you set the **BACKLIGHT** option to **BLC**, you will see a menu where you can set the **BLC** area.

you can set the desired **BLC** zone by defining the size and location.

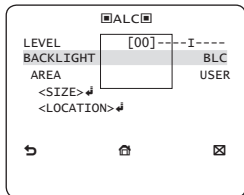

If you use an ordinary camera in a scene with an intensive backlight, the object will be

displayed dark on the monitor affected by the backlight. To solve this problem, you can use the **BLC**(Back Light Compensation) function to improve the sharpness of the image in such a high contrast scene.

- ❖ **AGC**
[OFF, VERY LOW, LOW, MID, HIGH, VERY HIGH, USER, FIX]

The **AGC** (Auto Gain Control) menu is used to set the **AGC** level of the camera. When the **AGC** is active, the camera automatically increases the sensitivity by amplifying the Video signal when the strength of the signal falls below the normal value.

If **OFF** or **FIX** mode is selected in the **SENS-UP** menu, you can specify the **AGC** level.

If you press the **SETUP** switch with a **USER** sub menu selected, you will see the appropriate screen.

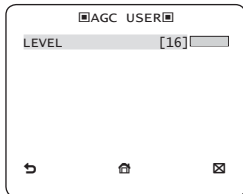

In **USER** mode, you can break down the level in 16 steps from **VERY LOW** to **VERY HIGH** to your preference.

ENG

English - 17

How to use OSD Menu

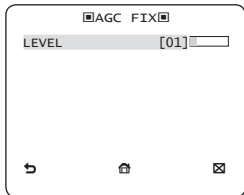

If you press the **SETUP** switch with a **FIX** sub menu selected, you will see the appropriate screen.

As a fixed value of the **AGC** gain is used in **FIX** mode, you can select one of the 16 detailed levels from **VERY LOW** to **VERY HIGH** before fixing it.

■ **Note :**

- If the **DAY/NIGHT** menu of the **CAMERA SET** is set to **AUTO**, the **AGC** menu will be deactivated.
- If **FLICKERLESS** is set to **ON**, the **AGC FIX** mode will be disabled.

❖ **MOTION** [S.SLOW, SLOW, NORM, FAST, F.FAST]

The **MOTION** menu is used to adjust the strength of the **AGC** level for a control of the camera motion. This is available only if the **SENS-UP** menu is set to **AUTO**.

You can select one from **S.SLOW**, **SLOW**, **NORM**, **FAST** and **F.FAST** for the **AGC** level.

If you monitor a fast moving object in a low contrast scene, select **F.FAST** while select **S.SLOW** for a hardly moving object in the same lighting condition.

18 – DIGITAL COLOR DOME CAMERA

■ **Note :**

- If the **DAY/NIGHT** menu of the **CAMERA SET** is set to **AUTO**, the **MOTION** menu will be deactivated.

❖ **DNR** [OFF,LOW,MID,HIGH, USER(1-16)]

You can configure the **DNR** (Digital Noise Reduction) related settings.

Reduces the noise on the screen.

This is especially useful for a severely distorted screen.

You can set the level if you set **DNR** to **USER**.

❖ **SHUTTER**

[OFF, AUTO 1/100(PAL:1/120), AUTO 1/250, AUTO 1/500, AUTO 1/1000, AUTO 1/2000, AUTO 1/4000, AUTO 1/10K , 1/100(PAL:1/120), 1/250, 1/500, 1/1000, 1/2000, 1/4000, 1/10K]

The **SHUTTER** menu is used to configure settings of the fixed / auto high-speed electronic shutter.

You can select one of 7 options from 1/100(PAL:1/120) to 1/10K for the fixed high speed electronic shutter, which is mostly used for imaging a fast moving object.

The auto high speed electronic shutter operates as the fixed high speed shutter in a high contrast scene but automatically focuses the target if the iris opens fully in a low contrast scene like in **ELC** mode. When it gets brighter back, the mode will switch to the fixed high speed electronic shutter mode.

However, the auto high speed shutter operates properly only in a camera featuring a DC or VIDEO lens.

How to use OSD Menu

■ Note :

- If the SENS-UP function is set to AUTO, only items of OFF and AUTO are available in the SHUTTER menu.
- If the SENS-UP mode is set to FIX, the SHUTTER menu will be deactivated.
- If the FLICKERLESS function is set to ON, the SHUTTER menu will be deactivated.

❖ SENS-UP

[OFF, AUTO X2, AUTO X4, AUTO X6, AUTO X8, AUTO X12, AUTO X16, AUTO X24, AUTO X32, AUTO X48, AUTO X64, AUTO X96, AUTO X128, AUTO X256, AUTO X512, FIX X2, FIX X4, FIX X6, FIX X8, FIX X12, FIX X16, FIX X24, FIX X32, FIX X48, FIX X64, FIX X96, FIX X128, FIX X256, FIX X512]

Automatically detects the ambient level of darkness in the dark or low contrast scene to extend the accumulated time, keeping the image bright and sharp; It can be also used as FIX mode.

■ Note :

- If the SHUTTER menu is set to fixed electronic shutter mode, the SENS-UP menu will not be available.
- If FLICKERLESS is set to ON, the FIX mode of the SENS-UP menu will be disabled.
- If the SHUTTER menu is set to AUTO, the SENS-UP menu can be set to either OFF or AUTO mode.

❖ FLICKERLESS [OFF, ON]

If set to ON, the shutter speed will be fixed to 1/100(PAL:1/120) second. This will prevent possible screen distortion due to a mismatch between the vertical sync frequency and the blinking frequency of the lighting.

■ Note :

- If the SHUTTER menu is set to AUTO or FIX mode, the FLICKERLESS menu will not be available.
- If the SENS-UP function is set to FIX mode, the Flickerless menu will be deactivated.
- If AGC is set to FIX mode, the FLICKERLESS function will be disabled.

❖ XDR (eXtended Dynamic Range) [OFF, LOW, MID, HIGH]

Actively controls the gamma compensation in the way it operates the ambient luminance contrast in a certain pixel unit to determine the optimal visibility.

Select one from OFF, LOW, MID and HIGH. Closing to HIGH will increase the compensation level.

❖ DAY/NIGHT [DAY,NIGHT,AUTO,EXT]

• DAY

If set to DAY, it will be fixed to DAY mode regardless of the ambient conditions.

• NIGHT

If set to NIGHT, it will be fixed to Black-and-White mode regardless of the ambient conditions.

How to use OSD Menu

If you press the **SETUP** switch with a **NIGHT** sub menu selected, you will see a menu where you can set Burst to **OFF/ON**.

If **BURST** is set to **ON**, the Burst signal will output together with the black-and-white composite video signal. If **BURST** is set to **OFF**, the Burst signal does not output.

You can set the **BURST** option to **OFF/ON**, or select to output the Burst signal in **NIGHT** mode.

• AUTO

The camera will automatically switch between **DAY** and **NIGHT** mode, according to the lighting condition.

If you press the **SETUP** switch with an **AUTO**-based sub menu selected, you will see the appropriate screen.

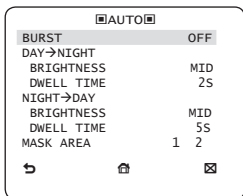

You can set the **BURST** option to **OFF/ON**, or select to output the Burst signal in **NIGHT** mode.

The **BRIGHTNESS** of **DAY→NIGHT** sets the brightness degree of color to BW switching,

for which you can select from **LOW**, **MID**, and **HIGH**. As you adjust it from **HIGH** to **LOW**, the screen switches to black and white mode under the darker situation.

DWELL TIME of **DAY→NIGHT** sets the time to maintain switched black and white mode.

The **BRIGHTNESS** of **NIGHT→DAY** sets the brightness degree of BW to color switching, for which you can select from **LOW**, **MID**, and **HIGH**. As you adjust it from **HIGH** to **LOW**, the screen switches to color mode under the darker situation.

DWELL TIME of **NIGHT→DAY** sets the time to maintain switched color mode.

The **MASK AREA** menu is used to prevent unintended mode switching or inability of determining the switching due to existence of high spot light source at night.

If you press the **SETUP** switch in item 1 or 2 of the **MASK AREA** menu, you will see a menu where you can specify an area to **MASK**.

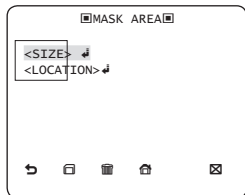

How to use OSD Menu

You can specify MASK 1 and 2 simultaneously. The MASK is only for determining the mode switching, and any excessive bright area at night will be excluded by the configured MASK.

▪ **Note :**

- If BACKLIGHT is set to BLC, the MASK AREA function will be deactivated.

❖ **WHITE BAL [DAY/NIGHT]**

If you want to adjust the color scheme, use the **WHITE BALANCE** function.

• **DAY**

In **DAY** mode, you can set the color values of **RED** and **BLUE**. The screen will be displayed in colors according to your settings.

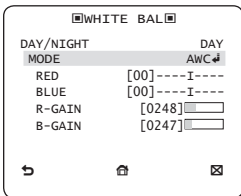

▪ **Note :**

- You can set the values of R-GAIN and B-GAIN only in AWC mode.

• **NIGHT**

Use the **NIGHT** mode if you want to set the white balance differently according to the ambient luminance.

If the **NIGHT** mode is set to **OFF**, the white balance will always operate as set in **DAY** mode; if not to **OFF**, the camera will switch to as set in **DAY/NIGHT** mode according to the brightness.

In **NIGHT** mode, you can set the values of **RED**, **BLUE** and **BRIGHTNESS**. The screen will be displayed in colors according to your settings.

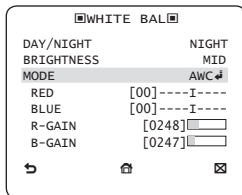

▪ **Note :**

- You can set the values of R-GAIN and B-GAIN only in AWC mode.
- If AGC is set to **OFF** or **FIX**, you can not access the **NIGHT** menu.
- For adjusting the white balance, the following 5 modes are provided:

ENG

How to use OSD Menu

- **ATW1**(Auto Tracing White Balance mode 1): The camera can automatically adjust the color temperature in real time, according to the ambient conditions. The color temperature ranges from approx. 2500K to 9300K.
- **ATW2**: The color temperature ranges from approx. 2,000K to 10,000K.
- **AWC** (Auto White Balance Control): If you press the **SETUP** switch in the appropriate item position, Auto White Balance will perform once.
- **3200K** : Set color temperature to 3200K
- **5600K** : Set color temperature to 5600K
- **RED** : Adjusts the strength of the red color.
- **BLUE** : Adjusts the strength of the blue color.
- **R-GAIN/B-GAIN** : Enables you to set the current color temperature manually.
- **BRIGHTNESS** : Select a brightness level in switching from setting in **DAY** mode to setting in **NIGHT** mode.

❖ DIGITAL ZOOM [ON/OFF]

You can set the digital zoom factor and position. If you press the **SETUP** switch with the **DIGITAL ZOOM** function set to **ON**, you will see the appropriate screen.

When the zoom factor and position are defined, the digital zoom function will operate.

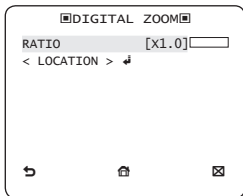

- **LOCATION** : If you press the **SETUP** switch in the condition where the image is enlarged as much as the ratio setting, you can watch an invisible area of the effective screen as well using the **▲▼◀▶** switch.

■ Note :

- If the digital zoom factor is set to larger than 1x, the **FENCE** function will be deactivated.
The **DIGITAL ZOOM** function enlarges the pixel itself, which can cause deterioration of the quality.

❖ DETAIL [0-3]

Controls the horizontal or vertical distinction.

❖ V-SYNC [INT, LINE]

Select the vertical sync mode for **INT** or **LINE**.

If you select **INT**, the camera will use the internal synchronization.

If selecting **LINE**, the camera will use the external power source frequency for the synchronization.

You can adjust the **LL-PHASE**.

How to use OSD Menu

■ **Note :**

- Use of DC 12V will fix V-SYNC to INT, which can not be changed.

❖ **AGC COLOR SUP** [LOW, MID, HIGH]

Adjust the color scheme according to the AGC value.

❖ **REVERSE** [OFF, H, V, H/V]

Mirrors video signals horizontally, vertically, or both.

❖ **POSI/NEGA** [+,-]

Output as it is or mirror the video brightness signal.

❖ **PIP** [OFF, ON]

Displays a sub image together with the main image on the same screen using the Picture In Picture function.

■ **Note :**

- If more than one privacy zone is set and the PRIVACY SET is set to ON, the PIP function will be deactivated.
- If the INTELLIGENCE function is set to FENCE mode, the PIP menu will be deactivated.

❖ **DIS** [OFF, ON]

Digital Image Stabilization will set the anti-shake compensation.

■ **Note :**

- If you set DIS to ON, the compensation area will be enlarged as set in the digital zoom factor.
- If you set the digital zoom factor to greater than the enlarged zoom factor for the compensation, the DIS function will be deactivated.

INTELLIGENCE

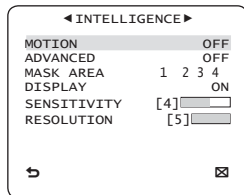

You can set the motion detection and tracking in the INTELLIGENCE menu.

❖ **MOTION** [OFF, TRACKING, DETECTION]

• **TRACKING**

Detects and tracks a moving object.

• **DETECTION**

Detects a moving object.

■ **Note :**

- If it is set to DETECTION, you can not set such functions as FIXED/MOVED and FENCE in the ADVANCED menu.

ENG

English - 23

How to use OSD Menu

◆ ADVANCED [OFF, FIXED/MOVED, FENCE]

Detects a motion of an object and displays an image of any moving object before tracking the moving route.

• FENCE

This is to detect if a moving object passes through the specified **LINE** or **AREA**.

In a condition where a moving object is detected in an analysis of the previous and current frames whose movement overlaps a certain area, the system displays "PASS" if the object's center line passes through the line while it displays "ENTER" or "EXIT" if the center point passes through the area.

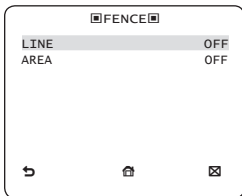

You can set the position and detection direction of the **LINE**, and the size and position of the **AREA**.

- How to set the line

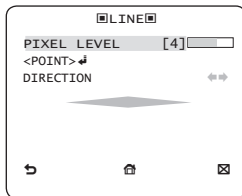

- ① If you press the **SETUP** switch with the **LINE** option set to **ON**, you can specify the position and detection direction of the line.
- ② If you change the **PIXEL LEVEL** for setting the position, specify the pixel that moves by a single pressure of the **▲▼◀▶** switch.
- ③ In **<POINT>**, you can specify the first position of the line by pressing the **SETUP** switch once, and the second position by pressing the switch again. Use the **▲▼◀▶** switch to specify the position. Set each position of the two points and press the **SETUP** switch to complete the positioning.
- ④ If you change the **DIRECTION**, you can specify the detection direction. The detection direction based on the defined two points will be displayed on the screen.

How to use OSD Menu

- How to set the area

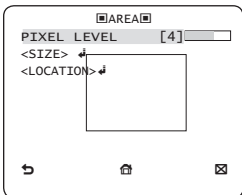

- ① If you press the **SETUP** switch with the **AREA** option set to **ON**, you can specify the position and size of the area.
- ② If you change the **PIXEL LEVEL** for setting the position, specify the pixel that moves by a single pressure of the **▲▼◀▶** switch.
- ③ In **<SIZE>**, press the **SETUP** switch and use the **▲▼◀▶** switch to adjust the size. Press the **SETUP** switch again to complete the sizing.
- ④ In **<LOCATION>**, press the **SETUP** switch and use the **▲▼◀▶** switch to specify the position. Press the **SETUP** switch again to complete the positioning.

▪ **Note :**

- If you set the **LINE** of the **FENCE** to **ON**, **PRIVACY 12** will not be available.
Functions of **FENCE**, **PIP**, **DIS** and **DIGITAL ZOOM** (if the digital zoom factor is set to larger than 1x) can not be

used simultaneously.

- In the boundary of the defined **AREA** and **LINE**, a **FENCE** detection error may occur if two or more moving objects overlap with each other or one object separates in multiple directions.

• **FIXED/MOVED**

If an object on the screen suddenly disappears or an object comes out of nowhere and stays for a certain time, the area will be displayed.

A detection (**FIXED/MOVED**) error may occur if :

- multiple motions occur continuously in random directions
- a fixed object moves in one position continuously
- a second object screens the first moving object

❖ **MASK AREA [1-4]**

Specify a detection exception area to mask.

Select a mask number and specify the size and position.

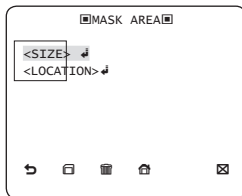

ENG

How to use OSD Menu

❖ DISPLAY [ON, OFF]

With the **DISPLAY** option set to **ON**, a motion or a set **ADVANCED** function will be displayed on the screen, if detected.

❖ SENSITIVITY [1-7]

Set the sensitivity of the motion detection.

❖ RESOLUTION [1-5]

If setting it to high, the camera can detect even a trivial movement of the target.

If you set the **PRIVACY SET** to **ON**, your **PRIVACY ZONE** settings will be applied.

You can change the style to adjust the mosaic size and color of the **PRIVACY ZONE**.

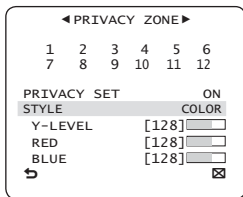

PRIVACY ZONE SETUP

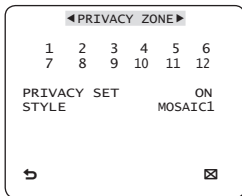

The **PRIVACY** function will protect your privacy by screening the privacy area that you have specified during monitoring. You can specify up to 12 privacy zones.

Use the ▲▼◀▶ switch to select one from **PRIVACY** 1 through 12.

Select one from **PRIVACY** 1-12 and press the **SETUP** switch to confirm your setting. You can specify a pixel that moves as you change the **PIXEL LEVEL** to set the position.

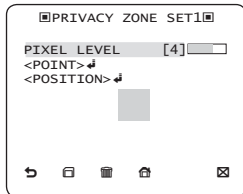

How to use OSD Menu

- How to set the point

You can set each position of the 4 points.

- ① If you press the **SETUP** switch in **<POINT>**, you will see the points available in the **PRIVACY ZONE**. Each time you press the **SETUP** switch, the points available will move.
- ② Use the **▲▼◀▶** switch to set the position of each point. Set each position of the four points and press the **SETUP** switch to complete the positioning.

- How to set the position

You can move the position of the overall area.

- ① By pressing the **SETUP** switch in **<POSITION>**, you can move the overall position of the privacy zone.
- ② Use the **▲▼◀▶** switch to move the position and press the **SETUP** switch to confirm it.

■ Note :

- If more than one **PRIVACY ZONE** is specified and the **PRIVACY SET** is set to **ON**, the **PIP** function will be deactivated.
- If the 12th **PRIVACY ZONE** is specified, the **LINE** function of **FENCE** will be deactivated.

OTHER SET

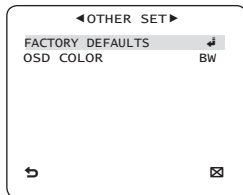

❖ FACTORY DEFAULTS

All the settings will be restored to the factory default.

❖ OSD COLOR [B/W, R/G/B]

You can set the OSD(On-screen Display) color to COLOR or B/W.

ENG

How to use OSD Menu

SYSTEM INFORMATION

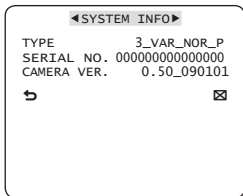

You can check the system information such as SERIAL NO and CAMERA VER.

LANGUAGE



The camera supports 5 different languages.
Select a preferred language.

◆ Initial Configuration Table

• Camera Configuration	
CAMERA ID	OFF
IRIS	ALC
AGC	VERY HIGH
MOTION	(F.FAST)
DNR	MID
SHUTTER	OFF
SENS-UP	AUTO x4
FLICKERLESS	(OFF)
XDR	MID
DAY/NIGHT	AUTO
DIGITAL ZOOM	OFF
DETAIL	[2]
AGC COLOR SUP	MID
REVERSE	H/V
POSI/NEGA	+
PIP	OFF
DIS	OFF
V-SYNC	INT

Specifications

SPECIFICATIONS

Items	Sub-items	SCC-B5396N/SCC-B5398N			
Camera Type	CCTV Camera				
Image	Device		1/3" Super-HAD IT CCD		
	Pixels	Total	811 x 508		
		Effective	768 x 494		
Scanning	System		Interface		
	Scanning Line		525 lines		
	Frame		30frame/1sec		
	Horizontal Frequency	Internal Mode	15,734 Hz		
		Line-lock Mode	15,750 Hz		
	Vertical Frequency	Internal Mode	59,94 Hz		
		Line-lock Mode	60 Hz		
Min. Scene Illumination	Condition			Min. Scene Illumination	
	Sens-up	F.No.	Level	DAY	NIGHT
	OFF	1.2	50 IRE	0.4 Lux	0.4 Lux
	OFF	1.2	30 IRE	0.24 Lux	0.24 Lux
	OFF	1.2	15 IRE	0.12 Lux	0.12 Lux
	512 times	1.2	50 IRE	0.0008 Lux	0.0008 Lux
	512 times	1.2	30 IRE	0.0005 Lux	0.0005 Lux
	512 times	1.2	15 IRE	0.00023 Lux	0.00023 Lux
Functions	Number of Privacy Zone		12 (Polygonal Method)		
	Day/Night		DAY/NIGHT/AUTO/EXT		
	Motion Detection		Off/Tracking/Detection		
	eXtended Dynamic Range(XDR)		Off/On (Level Setting)		
	D-Zoom		x1 ~ x16 (x0.1 STEP)		
	PIP		Off/On		
	High Speed Shutter		1/60 ~ 1/10Ksec (OSD/External Control)		
	Flickerless		Off/On		
	Sens-Up		x2 ~ x512		
BLC		Off/On (Area Setting)			

ENG

English - 29

Specifications

Items	Sub-items	SCC-B5396N/SCC-B5398N
	AGC	Off/On (Max.Level Setting)
	Line Lock	Off/On (Phase Control)
	Camera ID	Off/On (Max.54ea/2Line)
	White Balance	ATW1/ATW2/AWC/3200K/5600K
	Digital Noise Reduction(DNR)	Off/On (Adaptive 3D+2D)
	Digital Image Stabilization(DIS)	Off/On
	Intelligent Video	Fixed/Moved, Fence
	Etc. Function	Detail, Reverse(H/V), Posi/Nega
Resolution	Horizontal	600 TV Lines
	Vertical	350 TV Lines
Video Output	-	VBS 1.0Vp-p, 75 Ω
S/N Ratio	S/N Ratio	Approx. 52dB
Lens	Lens Drive Type	Auto Iris (DC)
		SCC-B5396 : focal length = 2.5 to 6.0mm / Aperture ratio = F 1.2 SCC-B5398 : focal length = 2.8 to 11.0mm / Aperture ratio = F 1.2
PAN	Range	0 ~ 355°(100° in CW(Clockwise) direction, 255° in CCW (Counterclockwise) direction)
TILT	Range	0 ~ 90°
Remote Control	Coaxitron (Data On Coax cable)	Yes (with SCX-RD100)
Environmental Conditions	Operating Temperature	-10°C ~ +50°C
	Humidity	Less than 90%
Power	Power Requirement	AC24V ± 10%(60Hz ± 0.3Hz) DC12V ± 10%
	Power Consumption	2.3W
Physical Specification	Dimensions (Ø x H)	150(Ø) x 121(H)mm
	Weight	980 g
	Color	white

30 – DIGITAL COLOR DOME CAMERA

Specifications

Items	Sub-items	SCC-B5398P/SCC-B5396P																																																								
Camera Type		CCTV Camera																																																								
Image	Device		1/3" Super-HAD IT CCD																																																							
	Pixels	Total	795 x 596																																																							
		Effective	752 x 582																																																							
Scanning	System		Interface																																																							
	Scanning Line		625 lines																																																							
	Frame		25frame/1sec																																																							
	Horizontal Frequency	Internal Mode	15,625 Hz																																																							
		Line-lock Mode	15,625 Hz																																																							
	Vertical Frequency	Internal Mode	50 Hz																																																							
		Line-lock Mode	50 Hz																																																							
Min. Scene Illumination	<table border="1"> <thead> <tr> <th rowspan="2">Sens-up</th> <th colspan="3">Condition</th> <th colspan="3">Min. Scene Illumination</th> </tr> <tr> <th>F.No.</th> <th>Level</th> <th>IRE</th> <th>DAY</th> <th>NIGHT</th> <th>Lux</th> </tr> </thead> <tbody> <tr> <td>OFF</td> <td>1.2</td> <td>50</td> <td>IRE</td> <td>0.4</td> <td>Lux</td> <td>0.4</td> </tr> <tr> <td>OFF</td> <td>1.2</td> <td>30</td> <td>IRE</td> <td>0.24</td> <td>Lux</td> <td>0.24</td> </tr> <tr> <td>OFF</td> <td>1.2</td> <td>15</td> <td>IRE</td> <td>0.12</td> <td>Lux</td> <td>0.12</td> </tr> <tr> <td>512 times</td> <td>1.2</td> <td>50</td> <td>IRE</td> <td>0.0008</td> <td>Lux</td> <td>0.0008</td> </tr> <tr> <td>512 times</td> <td>1.2</td> <td>30</td> <td>IRE</td> <td>0.0005</td> <td>Lux</td> <td>0.0005</td> </tr> <tr> <td>512 times</td> <td>1.2</td> <td>15</td> <td>IRE</td> <td>0.00023</td> <td>Lux</td> <td>0.00023</td> </tr> </tbody> </table>			Sens-up	Condition			Min. Scene Illumination			F.No.	Level	IRE	DAY	NIGHT	Lux	OFF	1.2	50	IRE	0.4	Lux	0.4	OFF	1.2	30	IRE	0.24	Lux	0.24	OFF	1.2	15	IRE	0.12	Lux	0.12	512 times	1.2	50	IRE	0.0008	Lux	0.0008	512 times	1.2	30	IRE	0.0005	Lux	0.0005	512 times	1.2	15	IRE	0.00023	Lux	0.00023
	Sens-up	Condition			Min. Scene Illumination																																																					
		F.No.	Level	IRE	DAY	NIGHT	Lux																																																			
	OFF	1.2	50	IRE	0.4	Lux	0.4																																																			
	OFF	1.2	30	IRE	0.24	Lux	0.24																																																			
	OFF	1.2	15	IRE	0.12	Lux	0.12																																																			
	512 times	1.2	50	IRE	0.0008	Lux	0.0008																																																			
	512 times	1.2	30	IRE	0.0005	Lux	0.0005																																																			
	512 times	1.2	15	IRE	0.00023	Lux	0.00023																																																			
	Number of Privacy Zone		12 (Polygonal Method)																																																							
Day/Night		DAY/NIGHT/AUTO/EXT																																																								
Motion Detection		Off/Tracking/Detection																																																								
eXtended Dynamic Range(XDR)		Off/On (Level Setting)																																																								
D-Zoom		Max. x16																																																								
PIP		Off/On																																																								
High Speed Shutter		1/50 ~ 1/10Ksec (OSD/External Control)																																																								
Flickerless		Off/On																																																								
Sens-Up		x2 ~ x512																																																								
BLC		Off/On (Area Setting)																																																								
Functions																																																										

ENG

English - 31

Specifications

Items	Sub-items	SCC-B5398P/SCC-B5396P
	AGC	Off/On (Max.Level Setting)
	Line Lock	Off/On (Phase Control)
	Camera ID	Off/On (Max.54ea/2Line)
	White Balance	ATW1/ATW2/AWC/3200K/5600K
	Digital Noise Reduction(DNR)	Off/On (Adaptive 3D+2D)
	Digital Image Stabilization(DIS)	Off/On
	Intelligent Video	Fixed/Moved, Fence
	Etc. Function	Detail, Reverse(H/V), Posi/Nega
Resolution	Horizontal	600 TV Lines
	Vertical	350 TV Lines
Video Output	-	VBS 1.0Vp-p, 75 Ω
S/N Ratio	S/N Ratio	Approx. 52dB
Lens	Lens Drive Type	Auto Iris (DC)
		SCC-B5396 : focal length = 2.5 to 6.0mm / Aperture ratio = F 1.2 SCC-B5398 : focal length = 2.8 to 11.0mm / Aperture ratio = F 1.2
PAN	Range	0 ~ 355°(100° in CW(Clockwise) direction, 255° in CCW (Counterclockwise) direction)
TILT	Range	0 ~ 90°
Remote Control	Coaxitron (Data On Coax cable)	Yes (with SCX-RD100)
Environmental Conditions	Operating Temperature	-10°C ~ +50°C
	Humidity	Less than 90%
Power	Power Requirement	AC24V ± 10%(50Hz ± 0.3Hz)
	Power Consumption	DC12V ± 10% 2.3W
Physical Specification	Dimensions (Ø x H)	150(Ø) x 121(H)mm
	Weight	980g
	Color	white

32 – DIGITAL COLOR DOME CAMERA



SAMSUNG

Correct Disposal of This Product (Waste Electrical & Electronic Equipment)



(Applicable in the European Union and other European countries with separate collection systems)

This marking on the product, accessories or literature indicates that the product and its electronic accessories (e.g. charger, headset, USB cable) should not be disposed of with other household waste at the end of their working life. To prevent possible harm to the environment or human health from uncontrolled waste disposal, please separate these items from other types of waste and recycle them responsibly to promote the sustainable reuse of material resources.

Household users should contact either the retailer where they purchased this product, or their local government office, for details of where and how they can take these items for environmentally safe recycling.

Business users should contact their supplier and check the terms and conditions of the purchase contract. This product and its electronic accessories should not be mixed with other commercial wastes for disposal.

Free Manuals Download Website

<http://myh66.com>

<http://usermanuals.us>

<http://www.somanuals.com>

<http://www.4manuals.cc>

<http://www.manual-lib.com>

<http://www.404manual.com>

<http://www.luxmanual.com>

<http://aubethermostatmanual.com>

Golf course search by state

<http://golfingnear.com>

Email search by domain

<http://emailbydomain.com>

Auto manuals search

<http://auto.somanuals.com>

TV manuals search

<http://tv.somanuals.com>