

HW-C450
HW-C451

Crystal Surround Air Track (Active Speaker System) user manual

imagine the possibilities

Thank you for purchasing this Samsung product.
To receive more complete service,
please register your product at
www.samsung.com/register



features

Active Speaker System

This unit features an Active Speaker System that provides high sound quality in a single slim unit.

This unit does not require any satellite loudspeakers or speaker cabling, which are normally associated with conventional surround sound systems.

Multi-function Remote Control

The supplied remote control can be used to control the TV connected to this unit.

The remote control has a TV hotkey that enables you to perform various operations with the simple press of a button.

You can adjust the volume, change the channel or customize the navigation menu of the TV using this Multi-function Remote Control.

Special Sound Field mode

You can select from 7 different sound field modes (NEWS, DRAMA, SPORTS, GAME, CINEMA, MUSIC and PASS (Original Sound)) depending on the type of content you want to enjoy.

Compatibility with various audio Technologies

This unit employs decoders compatible with Dolby Digital, DTS (Digital Theater Systems) and SFE (Sound Field Effect).

- Dolby Digital

This is the standard audio signal format used on DVDs and other purely digital media.

This surround technology delivers high-quality digital audio of up to 5.1 discrete channels to produce a directional and more realistic effect.

- DTS (Digital Theater Systems)

DTS provides a discrete 5.1 CH digital audio signal for both music and movie contents and uses less compression than Dolby Digital for richer sound.

- SFE (Sound Field Effect) Using 32bit Audio Digital Signal Processing

Provides more realistic surround sound with normal stereo audio sources.

Wireless Subwoofer

Samsung's wireless module does away with cables running between the main unit and the subwoofer.

Instead, the subwoofer connects to a compact wireless module that communicates with the main unit.

WHAT'S INCLUDED

Check for the supplied accessories below.

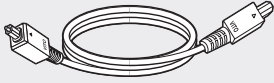
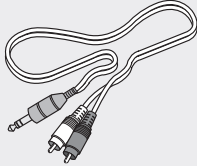
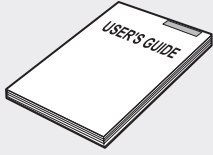
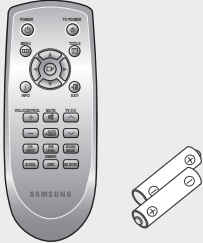
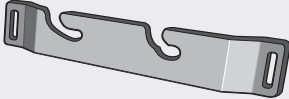
		
<p>Optical Cable</p>	<p>Audio Cable</p>	<p>User's Manual</p>
		
<p>Remote Control / Batteries (AAA size)</p>	<p>Bracket-Wall Mount</p>	



- The accessories may look slightly different than those pictured above.

safety information

SAFETY WARNINGS

TO REDUCE THE RISK OF ELECTRIC SHOCK, DO NOT REMOVE THE COVER(OR BACK).

NO USER-SERVICEABLE PARTS ARE INSIDE. REFER SERVICING TO QUALIFIED SERVICE PERSONNEL.



This symbol indicates “dangerous voltage” inside the product that presents a risk of electric shock or personal injury.



This symbol indicates important instructions accompanying the product.

WARNING : To reduce the risk of fire or electric shock, do not expose this appliance to rain or moisture.

CAUTION : TO PREVENT ELECTRIC SHOCK, MATCH WIDE BLADE OF PLUG TO WIDE SLOT, FULLY INSERT.

- This apparatus shall always be connected to a AC outlet with a protective grounding connection.
- To disconnect the apparatus from the mains, the plug must be pulled out from the mains socket, therefore the mains plug shall be readily operable.

CAUTION

- Apparatus shall not be exposed to dripping or splashing and no objects filled with liquids, such as vases, shall be placed on the apparatus.
- The Mains plug is used as a disconnect device and shall stay readily operable at any time.

PRECAUTIONS

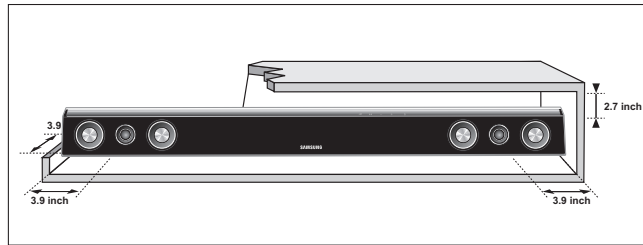

Ensure that the AC power supply in your house complies with the identification sticker located on the back of your product. Install your product horizontally, on a suitable base (furniture), with enough space around it for ventilation (3~4 inches). Make sure the ventilation slots are not covered. Do not place the unit on amplifiers or other equipment which may become hot. This unit is designed for continuous use. In order to disconnect the unit completely from the power supply, remove the main plug from the wall outlet, especially when left unused for a long period of time.

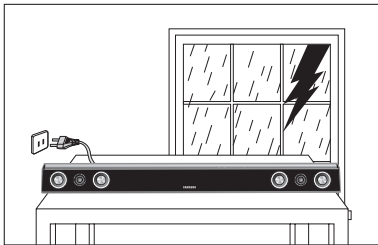

During thunderstorms, disconnect the AC main plug from the wall outlet. Voltage peaks due to lightning could damage the unit.

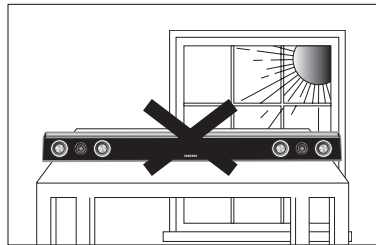

Do not expose the unit to direct sunlight or other heat sources. This could lead to overheating and malfunction of the unit.

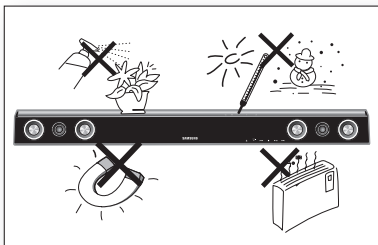

Protect the product from moisture (i.e. vases), and excess heat (e.g. fireplace) or equipment creating strong magnetic or electric fields. Disconnect the power cable from the AC supply if the unit malfunctions. Your product is not intended for industrial use. Use of this product is for personal use only.

Condensation may occur if your product or disc has been stored in cold temperatures. If transporting the unit during the winter, wait approximately 2 hours until the unit has reached room temperature before using.

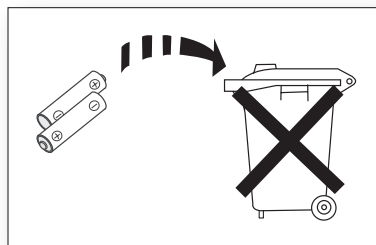

The batteries used with this product contain chemicals that are harmful to the environment. Do not dispose of batteries in the general household trash.



contents

FEATURES	2	Features
	3	What's included
SAFETY INFORMATION	4	Safety warnings
	5	Precautions
GETTING STARTED	7	Before reading the user's manual
DESCRIPTIONS	8	Front panel
	9	Rear panel
REMOTE CONTROL	10	Tour of the remote control
CONNECTIONS	11	Installing the wall mount
	12	Connecting the wireless subwoofer
	13	Connecting the Crystal Surround Air Track
FUNCTIONS	14	Basic functions
	14	Advanced functions
	16	Software upgrade
TROUBLESHOOTING	17	Troubleshooting
APPENDIX	18	Specifications

BEFORE READING THE USER'S MANUAL

Make sure to check the following terms before reading the user manual.

Icons that will be used in manual

Icon	Term	Definition
	Caution	This involves a case where a function does not operate or settings may be canceled.
	Note	This involves tips or instructions on the page that help each function operate.

About the use of this user's manual

- 1) Be sure to be familiar with Safety Instructions before using this product. (See page 4)
- 2) If a problem occurs, check the Troubleshooting. (See page 17)

Copyright

©2010 Samsung Electronics Co.,Ltd.

All rights reserved; no part or whole of this user's manual may be reproduced or copied without the prior written permission of Samsung Electronics Co.,Ltd.

descriptions

FRONT PANEL

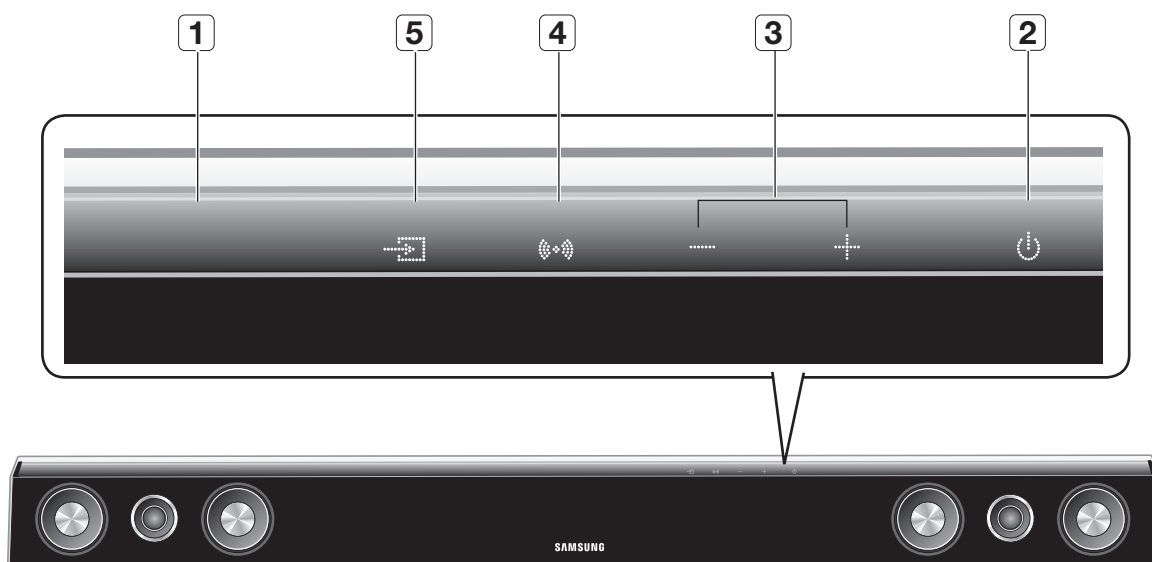

1	DISPLAY	Displays the current mode.
2	POWER BUTTON	Turns the Crystal Surround Air Track on and off.
3	VOLUME +/-	Controls the volume level.
4	SOUND FIELD MODE	Selects the sound field mode. (NEWS, DRAMA, SPORTS, GAME, CINEMA, MUSIC and PASS(Original Sound))
5	INPUT MODE	Selects the Optical or Audio input.



- When you turn on the power of this unit, there will be a 4 to 5 second delay before it can reproduce sound.

REAR PANEL

ENG

DESCRIPTION

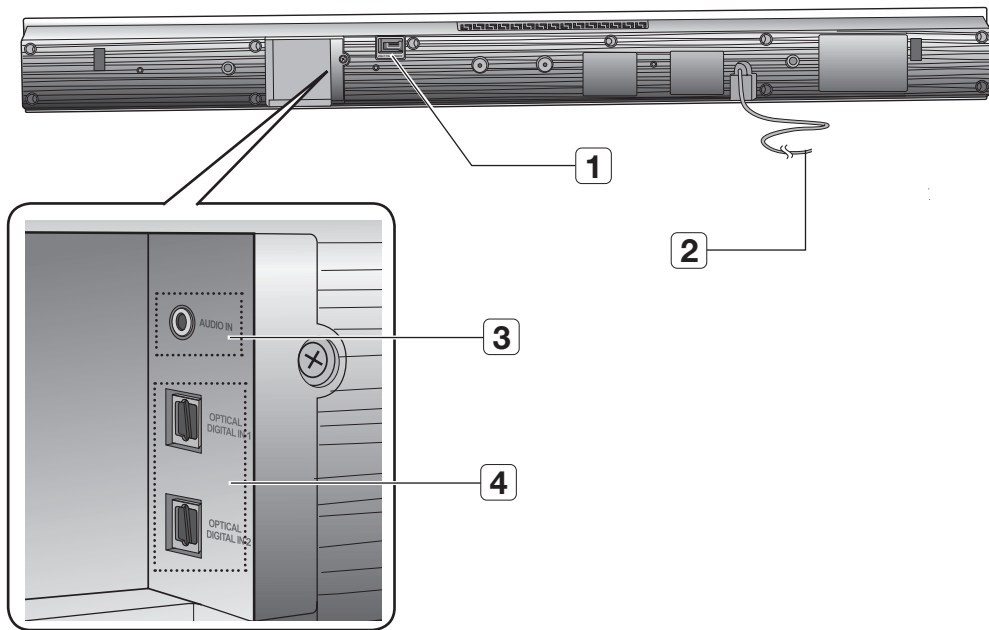

1	USB PORT	You can update this unit through the USB port.
2	POWER SUPPLY CABLE	Plug the power supply cable into the AC wall outlet.
3	AUDIO IN JACK	Connect to the analog output of an external device.
4	OPTICAL DIGITAL IN 1,2	Connect to the digital (optical) output of an external device.

- !** When disconnecting the power cable from the wall outlet, hold the plug. Do not pull the cable.
- Do not connect this unit or other components to the main power until all connections between components are complete.

remote control

TOUR OF THE REMOTE CONTROL

POWER BUTTON

Turns the Crystal Surround Air Track on and off.

ADJUST THE TV NAVIGATION MENU

Adjusts and selects an item of the navigation menu on your Samsung TV.

VOL/CONTROL

Adjusts the volume level of the unit.

O/A INPUT

Selects the Digital (Optical) or the Audio input.

SMART VOLUME

Regulate and stabilize the volume level against a drastic volume change.

DRC/DIMMER

You can use this function to enjoy Dolby Digital sound when watching movies at low volume at night (Standard, MAX, MIN). You can control the brightness of the Display.

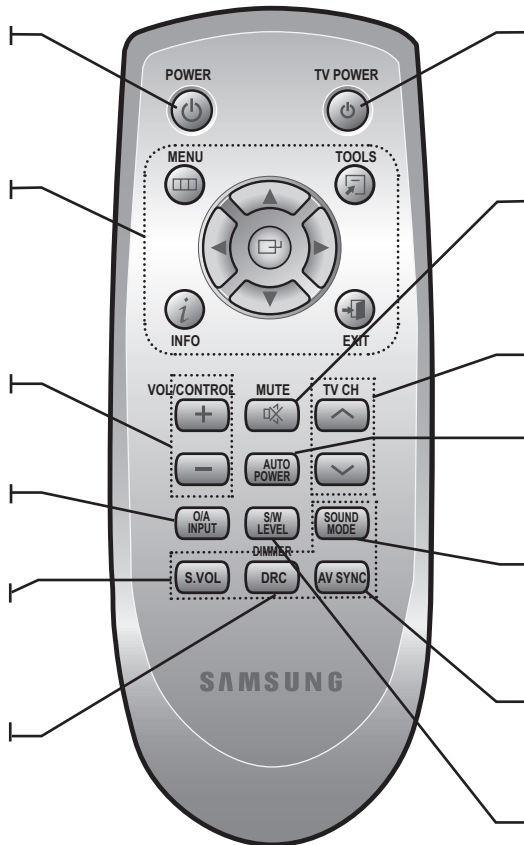

TV POWER BUTTON

Turns your Samsung TV on and off.

MUTE

Mutes the sound from the unit. Press again to restore the sound to the previous volume level.

TV CHANNEL

Switches between the available TV channels.

AUTO POWER LINK

Synchronizes to turn the unit on with the optical signal from the TV.

SOUND MODE

Selects the sound field mode. (NEWS, DRAMA, SPORTS, GAME, CINEMA, MUSIC and PASS(Original Sound))

AV SYNC

Used to help sync video to audio when connected to a digital TV.

S/W LEVEL

Adjusts the Subwoofer level.



- The remote control can operate TVs made by SAMSUNG only.
- Depending on the TV you are using, you may not be able to operate your TV with this remote control. In this case, operate the TV using the TV's remote control.

Installing batteries in the Remote Control

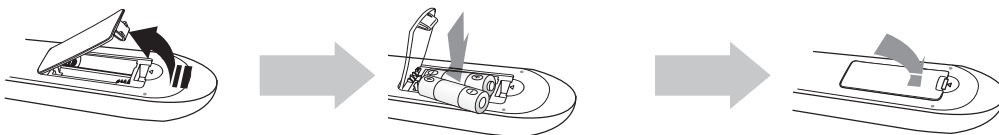

1. Lift the cover at the back of the remote control upward as shown.
2. Install two AAA size batteries. Make sure to match the "+" and "-" ends of the batteries with the diagram inside the compartment.
3. Replace the cover. Assuming typical TV usage, the batteries last for about one year.

Operation Range of the Remote Control

The remote control can be used up to approximately 23 feet (7 meters) in a straight line. It can also be operated at a horizontal angle of up to 30° from the remote control sensor.

INSTALLING THE WALL MOUNT

You can use the wall mount bracket to mount this unit on a wall.

Installation Precautions

- Do not install on a place other than vertical wall.
- For the installation, avoid high temperature or humidity, or wall that cannot sustain the weight of the set.
- Check the strength of the wall. If the strength of the wall is insufficient for the product installation, make sure to reinforce the wall before the installation.
- Check the material of the wall. If the wall is made of plaster board, marble, or iron board, purchase and use the appropriate fixing screws.
- Cables connecting to external devices are to be connected to the set before installing.
- Be sure to turn off and unplug the unit before installation. Otherwise, it may cause electric shock.

1. Place the wall mount bracket on a wall surface and then secure it with two screws (not supplied).

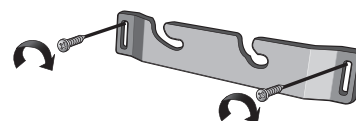

2. Then, fit the unit into the corresponding slots of the wall mount bracket. For secure installation, make sure the mounting studs slide firmly down into the bottom of the slots.

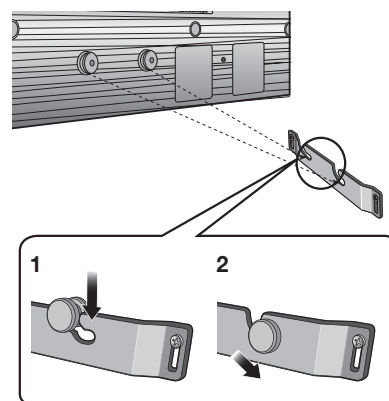

3. This is the completion of the suggested wall mount installation.

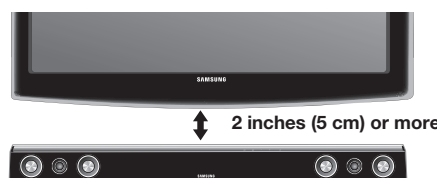

- Do not hang onto the installed unit and avoid any impact to the unit.
- Secure the unit firmly to the wall so that it does not fall off. If the unit falls off, it may result in an injury or damage to the product.
- When the unit is installed on a wall, please make sure that a child does not pull any of connecting cables, as it may cause it to fall.
- For the optimal performance in a wall mount installation, keep the speaker system at least 2 inches (5 cm) distant from the TV.

CONNECTING THE WIRELESS SUBWOOFER

The Subwoofer's linking ID is preset at the factory and the main unit and sub should link (connect wirelessly) automatically when main unit is turned on. If the link indicator does not light when main unit and subwoofer are turned on, please set the ID by following the process below.

1. Plug the power cords of the main unit and subwoofer into an AC power supply.
2. Press the **ID SET** button on the back of the subwoofer with a small, pointed object for 5 seconds.
 - The **STANDBY** indicator is turned off and the **LINK** indicator (Blue LED) blinks quickly.

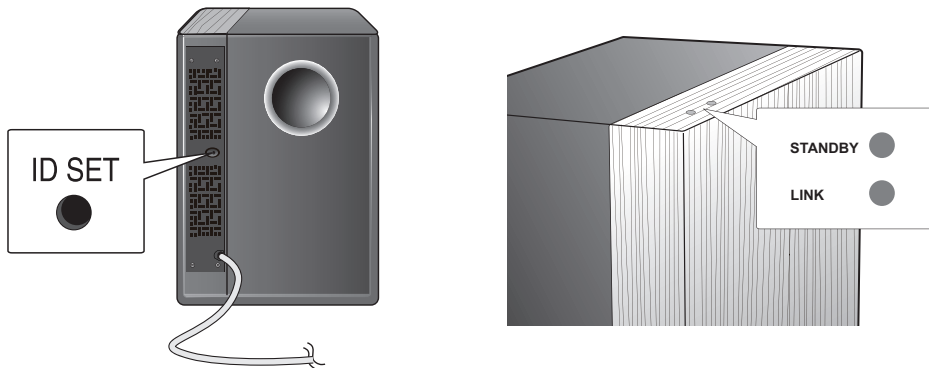

3. While the main unit is powered off (**STANDBY** mode), press **MUTE** on the remote control for 5 seconds.
4. The Power Indicator on the main unit lights off and on, then returns to **STANDBY** mode.
 - The main unit and the subwoofer are now linked (connected).
 - The Link indicator (blue LED) on the subwoofer is turned on.
 - You can enjoy better sound from the wireless subwoofer by selecting the sound field mode. (See page 15)



- Before moving or installing the product, be sure to turn off the power and disconnect the power cord.
- If the main unit is powered off, the wireless subwoofer will be in the standby mode and the **STANDBY** LED on the upper side will come on after 30 seconds Link indicator(Blue LED) blinking.
- If you use a device such as a microwave oven, wireless LAN Card, Bluetooth equipment, or any other device that uses the same frequency (2.4GHz or 5.8GHz) near the system, some sound interruption may be heard due to interference.
- The transmission distance of the wireless signal between the main unit and sub is about 33 ft., but may vary depending on your operating environment. If a steel-concrete or metallic wall is between the main unit and the wireless subwoofer, the system may not operate at all, because the wireless signal cannot penetrate metal.
- If the main unit doesn't make wireless connection, follow steps 1-4 above to retry the connection between the main unit and wireless subwoofer.

- The wireless receiving antenna is built into the wireless subwoofer. Keep the unit away from water and moisture.
- For optimal listening performance, make sure that the area around the wireless subwoofer location is clear of any obstructions.

CONNECTING THE CRYSTAL SURROUND AIR TRACK

This section explains two ways (digital and analog) of connecting the unit to the TV.

This unit is equipped with two optical digital jacks and one audio analog jack for connecting a TV.

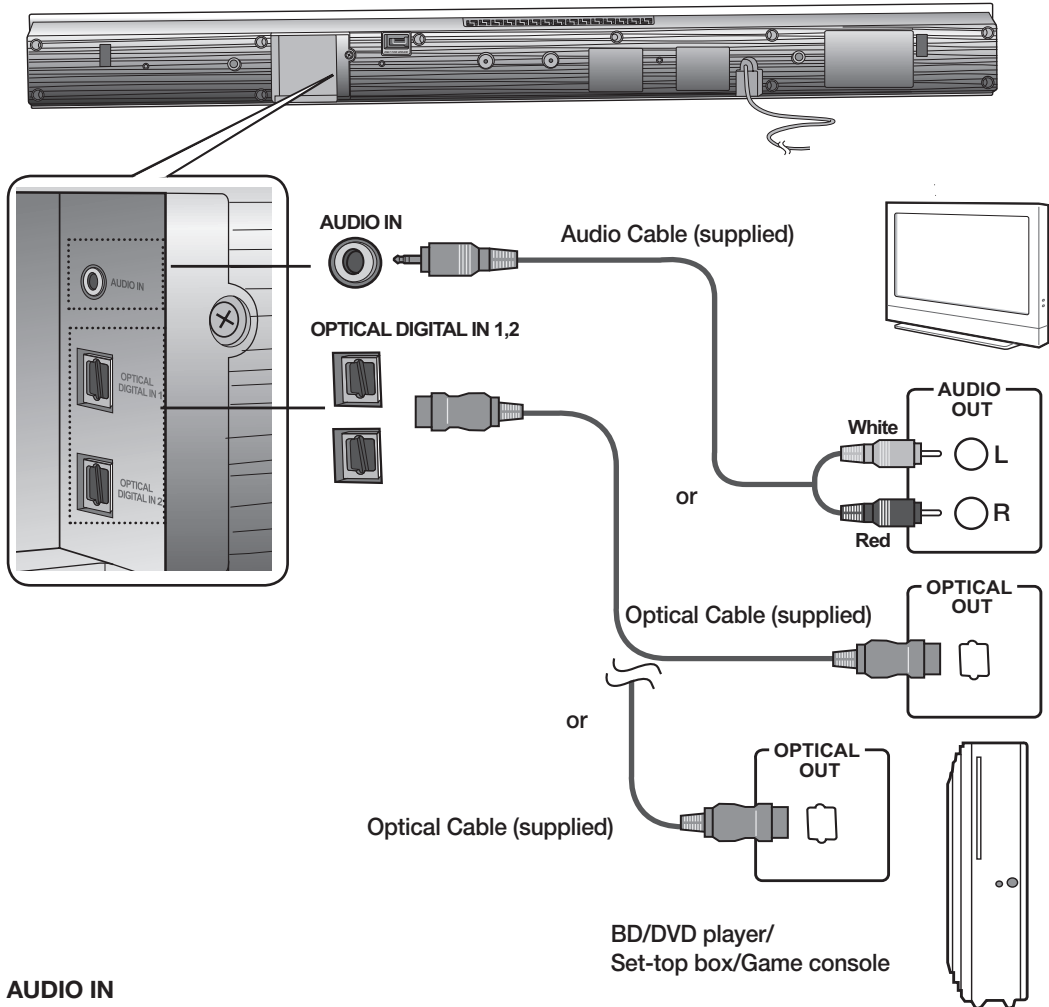

AUDIO IN

Connect AUDIO IN on the main unit to the AUDIO OUT of the TV. Be sure to match connector colors.

OR,

OPTICAL DIGITAL IN 1,2

Connect the Digital Input on the main unit to the OPTICAL OUT of the TV or Source Device.



- Do not connect the power cord of this product or your TV to the wall outlet until all connections between components are complete.
- Before moving or installing this product, be sure to turn off the power and disconnect the power cord.
- You can connect this unit to other external components. (such as DVD player, Set-Top Box etc.)
- Only one optical cable is supplied.
- If you select 'ANALOG' without connecting the Audio Cable, the set is turned off automatically after 20 minutes.

functions

BASIC FUNCTIONS

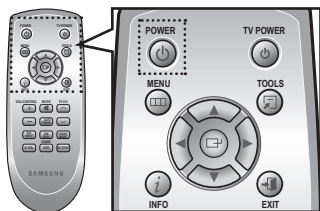

Turning the power on/off

1. Touch **POWER** (⏻) on the front panel.
OR,
Press **POWER** on the remote control to turn on the power.
2. Touch **POWER** (⏻) on the front panel.
OR,
Press **POWER** on the remote control again to turn off the power.

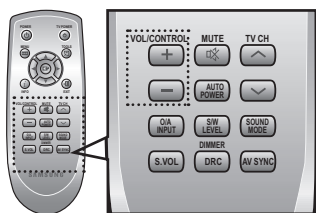

Adjusting the volume

- Touch **VOLUME +/-** on the front panel.
- OR,
- Press **VOLUME +/-** on the remote control to increase or decrease the volume level.
- The numeric value of the volume level appears in the front panel display.



- The volume level increases or decreases when you press VOLUME +/-.
- If you want to enjoy the sound only from the Crystal Surround Air Track, you must turn off the TV's speakers in the Audio Setup menu of your TV. Refer to the owner's manual supplied with your TV.

ADVANCED FUNCTIONS

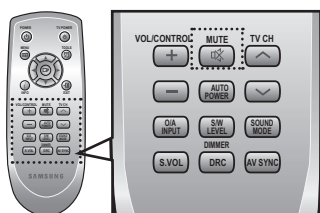

Muting the sound

- This is useful when answering a doorbell or telephone call.
1. Press **MUTE** (⏻) on the remote control to mute the sound.
 2. Press **MUTE** on the remote control again (or press **VOLUME +/-**) to restore the sound.

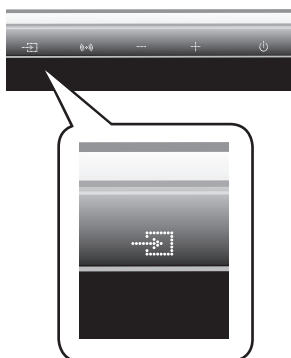

Selecting the input mode

You can select either Optical Digital in or Audio input.
Press **O/A INPUT** on the remote control or touch **INPUT MODE** on the front panel repeatedly to select the Optical Digital in or Audio input.

Input mode		Display
Optical Digital in	PCM	PCM
	DOLBY	D.D
	DTS	DTS
Audio input		ANALOG

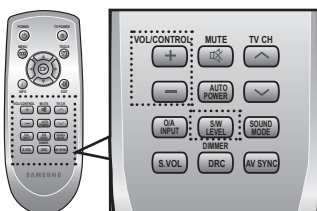
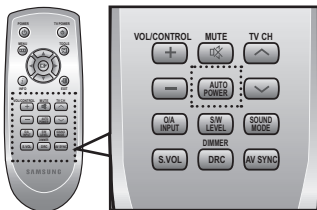
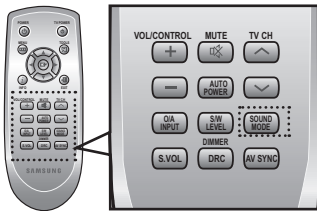

Using the sound field mode

You can select from 7 different sound field modes (NEWS, DRAMA, SPORTS, GAME, CINEMA, MUSIC and PASS (Original Sound)) depending on the type of sources you want to enjoy.

Press **SOUND MODE** on the remote control or touch **SOUND FIELD MODE** on the front panel repeatedly to select the sound field mode you want.

Sound field mode	Function
PASS	Select PASS mode if you want to enjoy the original sound.
MUSIC	Select MUSIC mode when you play music sources.
NEWS	Select NEWS mode when you play news sources.
DRAMA	Select DRAMA mode when you play drama sources.
CINEMA	Select CINEMA mode when you play movie sources.
SPORTS	Select SPORTS mode when you play sports sources.
GAME	Select GAME mode when you play game sources.

Using the AUTO POWER LINK function

The Crystal Surround Air Track is automatically turned on when you turn the power on of a TV or any device connected to the Air Track with the optical cable.

Press **AUTO POWER** on the remote control of this unit.

- Auto power link function turns on and off each time you press **AUTO POWER**.

AUTO POWER LINK	Display
ON	POWER LINK ON
OFF	POWER LINK OFF



- If a TV or any device connected to Air Track with the optical cable is off and there is no digital input, the Air Track is turned off after 20 minutes.

Using the TV functions

- Press **TV POWER** on the remote control of this unit.
- Press **TV CH** on the remote control to select the TV channel.



- The remote control can operate TVs made by SAMSUNG only.

Using the S/W LEVEL function

You can control the base volume with S/W Level key in the Remote control.

- Press the **S/W Level** button on the Remote control.
- "SW 00" is appeared on the Display.
- Press "+" on the **VOL/CONTROL** key if you want to increase the subwoofer volume. You can set it from SW+01 to SW+06.
- Press "-" on the **VOL/CONTROL** key if you want to decrease the subwoofer volume. You can set it from SW-01 to SW-06.

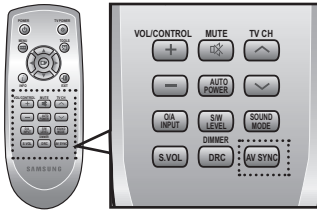

Using the AV SYNC function

Video may look slower than the audio if it is connected with digital TV. If this occurs, adjust the audio delay time to match the video.

Press **AV SYNC** on the remote control of this unit repeatedly .

- You can use + , - button to set the audio delay time between 0 ms and 300 ms.

Using the DRC function

This feature balances the range between the loudest and quietest sounds. You can use this function to enjoy Dolby Digital sound when watching movies at low volume at night.

Press **DRC** on the remote control of this unit.

- Each time the button is pressed, the selection changes as follows :
DRC MIN ➔ DRC STANDARD ➔ DRC MAX

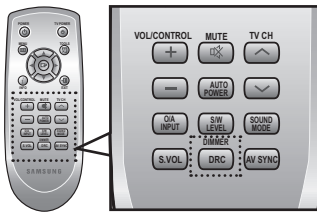

Using the DIMMER function

Press Dimmer to control the brightness of the Display.

If you press and hold the **DRC(DIMMER)** button for over 4seconds, the Display is dimmed and the message "**DIMMER LEVEL 1**" is appears on the Display. If the button is pressed and held again, the Display is brightened and the message "**DIMMER LEVEL 2**" appears on the Display.

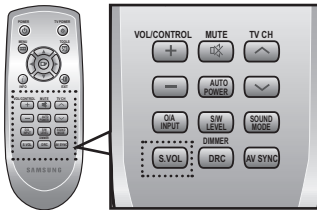

Using the S.VOL function

This will regulate and stabilize the volume level against a drastic volume change in case of a channel change or scene transition.

Press **S.VOL** on the remote control of this unit.

- Each time the button is pressed, the selection changes as follows :
S.VOL ON ➔ S.VOL OFF

SOFTWARE UPGRADE

Samsung may offer upgrades for the Crystal Surround Air Track's system's firmware in the future.

Please visit Samsung.com or contact the Samsung call center to receive information about downloading upgrades and using a USB drive.

Upgrades will be possible by connecting a USB drive to the USB port located on your Air Track.

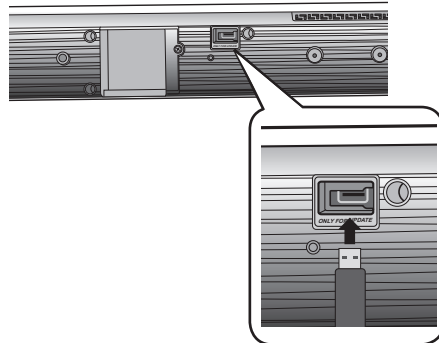

- Insert a USB drive containing the firmware upgrade into the USB port on the back of the main unit.
- Please be careful to not disconnect the power or remove the USB drive while upgrades are being applied. The main unit will turn off automatically after completing the firmware upgrade. When software is upgraded, settings you have made will return to their default (factory) settings. We recommend you write down your settings so that you can easily reset them after the upgrade.
- If you fail to upgrade the firmware, we recommend formatting the USB data in FAT16 and trying again.
- For upgrading purposes, do not format USB data in NTFS because it is not a supported file system.
- Depending on the manufacturer, the USB may not be supported.

troubleshooting

Before requesting service, please check the following.

Symptom	Check	Remedy
The unit will not turn on.	<ul style="list-style-type: none">• Is the power cord plugged into the outlet?	<ul style="list-style-type: none">• Connect the power plug to the outlet.
A function does not work when the button is pressed.	<ul style="list-style-type: none">• Is there static electricity in the air?	<ul style="list-style-type: none">• Disconnect the power plug and connect it again.
Sound is not produced.	<ul style="list-style-type: none">• Is the unit properly connected to your TV?• Is the Mute function on?• Is the volume set to minimum?	<ul style="list-style-type: none">• Connect it correctly.• Press the Mute button to cancel the function.• Adjust the volume.
Picture does not appear on a TV when the function is selected.	<ul style="list-style-type: none">• Is the TV connected properly?	<ul style="list-style-type: none">• Connect it correctly.
Remote control does not work.	<ul style="list-style-type: none">• Are the batteries drained?• Is the distance between remote control and main unit too far?	<ul style="list-style-type: none">• Replace with new batteries.• Operate at a close distance.
The sound from the left/right channels is reversed.	<ul style="list-style-type: none">• Are the left/right audio output cables from the TV connected properly?	<ul style="list-style-type: none">• Check the left/right channel and connect it/them correctly.

appendix

SPECIFICATIONS

GENERAL	Power supply		AC 120V, 60Hz
	Standby power consumption		0.75W
	Power consumption	Main unit	45W
		Subwoofer	20W
	Weight	Main unit	5.01 lbs
		Subwoofer	12.01lbs
	Dimensions (W x H x D)	Main unit	37.66 x 3.62 x 1.77 inches
		Subwoofer	6.89 x 13.78 x 11.61 inches
	Operating temperature range		+41°F to +95°F
Operating humidity range		10 % to 75 %	
AMPLIFIER	Rated output power	Main unit	80W/CH, 4Ω, THD = 10%, 1kHz
		Subwoofer	120W, 4Ω, THD = 10%, 100Hz
	Input sensitivity/Impedance		450mV/20KΩ
	S/N ratio (analog input)		65dB
	Separation(1kHz)		70dB
FREQUENCY RESPONSE	Analog input		20Hz~20kHz(±3dB)
	Digital input/48kHz PCM		20Hz~20kHz(±3dB)

* S/N ratio, distortion, separation and usable sensitivity are based on measurement using AES (Audio Engineering Society) guidelines.

*: Nominal specification

- Samsung Electronics Co., Ltd reserves the right to change the specifications without notice.
- Weight and dimensions are approximate.



SAMSUNG

LIMITED WARRANTY TO ORIGINAL PURCHASER

Samsung Electronics Canada Inc.(SECA), warrants that this product is free from defective material and workmanship.

SECA further warrants that if this product falls to operate properly within the specified warranty period and the failure is due to improper workmanship or defective materials, SECA will repair or replace the product at its option.

All warranty repairs must be performed by a SECA Authorized Service Center. (The name and address of the location nearest you can be obtained by calling toll free: 1- 800- SAMSUNG)

LABOR
One year (Carry- in)

PARTS
One year

On carry-in models, transportation to and from the service center is the customer's responsibility.

The original dated sales receipt must be retained by the customer and is the only acceptable proof of purchase. It must be presented to the authorized service center at the time service is requested.

EXCLUSIONS (WHAT IS NOT COVERED)

This warranty does not cover damage due to accident, fire, flood and/ or other acts of God; misuse, incorrect line voltage, improper installation, improper or unauthorized repairs, commercial use or damage that occurs in shipping. Exterior and interior finish, lamps, glass are not covered under this warranty. Customer adjustments which are explained in the instruction manual are not covered under the terms of this warranty. This warranty will automatically be voided for any unit found with a missing or altered serial number. This warranty is valid only on products purchased and used in Canada.

**HEADQUARTERS
SAMSUNG ELECTRONICS CANADA INC.,
CUSTOMER SERVICE
55 STANDISH COURT MISSISSAUGA, ONTARIO L5R 4B2 CANADA
FABRIQUE EN CORÉE
1-800-SAMSUNG (1-800-7267864)
WWW.SAMSUNG.COM/CA**

Contact SAMSUNG WORLD WIDE

If you have any questions or comments relating to Samsung products, please contact the SAMSUNG customer care center.

Area	Contact Center ☎	Web Site
▪ North America		
Canada	1-800-SAMSUNG (726-7864)	www.samsung.com
Mexico	01-800-SAMSUNG (726-7864)	www.samsung.com
U.S.A	1-800-SAMSUNG (726-7864)	www.samsung.com
▪ Latin America		
Argentine	0800-333-3733	www.samsung.com
Brazil	0800-124-421 4004-0000	www.samsung.com
Chile	800-SAMSUNG (726-7864)	www.samsung.com
Nicaragua	00-1800-5077267	www.samsung.com
Honduras	800-7919267	www.samsung.com
Costa Rica	0-800-507-7267	www.samsung.com
Ecuador	1-800-10-7267	www.samsung.com
El Salvador	800-6225	www.samsung.com
Guatemala	1-800-299-0013	www.samsung.com
Jamaica	1-800-234-7267	www.samsung.com
Panama	800-7267	www.samsung.com
Puerto Rico	1-800-682-3180	www.samsung.com
Rep. Dominica	1-800-751-2676	www.samsung.com
Trinidad & Tobago	1-800-SAMSUNG (726-7864)	www.samsung.com
Venezuela	0-800-100-5303	www.samsung.com
Colombia	01-8000112112	www.samsung.com
▪ Europe		
Austria	0810 - SAMSUNG (7267864, € 0.07/min)	www.samsung.com
Belgium	02-201-24-18	www.samsung.com/ be (Dutch) www.samsung.com/ be_fr (French)
Czech	800 - SAMSUNG (800-726786)	www.samsung.com
Denmark	70 70 19 70	www.samsung.com
Finland	030 - 6227 515	www.samsung.com
France	01 48 63 00 00	www.samsung.com
Germany	01805 - SAMSUNG (726-7864 € 0,14/Min)	www.samsung.com
Hungary	06-80-SAMSUNG (726-7864)	www.samsung.com
Italia	800-SAMSUNG (726-7864)	www.samsung.com
Luxemburg	261 03 710	www.samsung.com
Netherlands	0900-SAMSUNG (0900-7267864) (€ 0,10/Min)	www.samsung.com
Norway	815-56 480	www.samsung.com
Poland	0 801 1SAMSUNG (172678) 022-607-93-33	www.samsung.com
Portugal	80820-SAMSUNG (726-7864)	www.samsung.com
Slovakia	0800-SAMSUNG (726-7864)	www.samsung.com
Spain	902 - 1 - SAMSUNG (902 172 678)	www.samsung.com
Sweden	0771 726 7864 (SAMSUNG)	www.samsung.com
U.K	0845 SAMSUNG (7267864)	www.samsung.com
Eire	0818 717100	www.samsung.com

Area	Contact Center ☎	Web Site
Switzerland	0848 - SAMSUNG (7267864, CHF 0.08/min)	www.samsung.com/ch www.samsung.com/ ch_fr/ (French)
Lithuania	8-800-77777	www.samsung.com
Latvia	8000-7267	www.samsung.com
Estonia	800-7267	www.samsung.com
▪ CIS		
Russia	8-800-555-55-55	www.samsung.com
Georgia	8-800-555-555	
Armenia	0-800-05-555	
Azerbaijan	088-55-55-555	
Kazakhstan	8-10-800-500-55-500	
Uzbekistan	8-10-800-500-55-500	www.samsung.com
Kyrgyzstan	00-800-500-55-500	www.samsung.com
Tadjikistan	8-10-800-500-55-500	www.samsung.com
Ukraine	0-800-502-000	www.samsung.ua www.samsung.com/ ua_ru
Belarus	810-800-500-55-500	
Moldova	00-800-500-55-500	
▪ Asia Pacific		
Australia	1300 362 603	www.samsung.com
New Zealand	0800 SAMSUNG (0800 726 786)	www.samsung.com
China	400-810-5858 010-6475 1880	www.samsung.com
Hong Kong	(852) 3698-4698	www.samsung.com/ hk www.samsung.com/ hk_en/
India	3030 8282 1800 110011 1800 3000 8282 1800 266 8282	www.samsung.com
Indonesia	0800-112-8888 021-5699-7777	www.samsung.com
Japan	0120-327-527	www.samsung.com
Malaysia	1800-88-9999	www.samsung.com
Philippines	1-800-10-SAMSUNG (726-7864) 1-800-3-SAMSUNG (726-7864) 1-800-8-SAMSUNG (726-7864) 02-5805777	www.samsung.com
Singapore	1800-SAMSUNG (726-7864)	www.samsung.com
Thailand	1800-29-3232 02-689-3232	www.samsung.com
Taiwan	0800-329-999	www.samsung.com
Vietnam	1 800 588 889	www.samsung.com
▪ Middle East & Africa		
Turkey	444 77 11	www.samsung.com
South Africa	0860-SAMSUNG (726-7864)	www.samsung.com
U.A.E	800-SAMSUNG (726-7864)	www.samsung.com
Bahrain	8000-4726	
Jordan	800-22273	



AH68-02273S

Free Manuals Download Website

<http://myh66.com>

<http://usermanuals.us>

<http://www.somanuals.com>

<http://www.4manuals.cc>

<http://www.manual-lib.com>

<http://www.404manual.com>

<http://www.luxmanual.com>

<http://aubethermostatmanual.com>

Golf course search by state

<http://golfingnear.com>

Email search by domain

<http://emailbydomain.com>

Auto manuals search

<http://auto.somanuals.com>

TV manuals search

<http://tv.somanuals.com>