

HT-SB1G
HT-SB1R
HT-WS1G
HT-WS1R

Crystal Surround Air Track (Active Speaker System) user manual

imagine the possibilities

Thank you for purchasing this Samsung product.
To receive more complete service,
please register your product at
www.samsung.com/register



features

Active Speaker System

This unit features an Active Speaker System that provides high sound quality in a single slim unit.

This unit does not require any satellite loudspeakers or speaker cabling, which are normally associated with conventional surround sound systems.

Multi-function Remote Control

The supplied remote control can be used to control the TV connected to this unit.

The remote control has a TV hotkey that enables you to perform various operations with the simple press of a button.

You can adjust the volume, change the channel or customize the navigation menu of the TV using this Multi-function Remote Control.

Special Sound Field mode

You can select from three different sound field modes (NEWS, CINEMA and MUSIC) depending on the type of the source you want to enjoy.

Compatibility with the Technologies

This unit employs decoders compatible with Dolby Digital, DTS (Digital Theater Systems) and SFE (Sound Field Effect).

- **Dolby Digital**

This is the standard audio signal format used on DVDs and other purely digital media.

This surround technology delivers high-quality digital audio of up to 5.1 discrete channels to produce a directional and more realistic effect.

- **DTS (Digital Theater Systems)**

DTS provides a discrete 5.1 CH digital audio signal for both music and movie contents and uses less compression than Dolby Digital for richer sound.

- **SFE (Sound Field Effect) Using 32bit Audio Digital Signal Processing**

Provides more realistic surround sound with normal stereo audio sources.



Wireless Subwoofer (HT-WS1G/HT-WS1R only)

Samsung's wireless module does away with cables running between the main unit and the subwoofer.

Instead, the subwoofer connects to a compact wireless module that communicates with the main unit.

WHAT'S INCLUDED

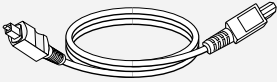
Check for the supplied accessories below.

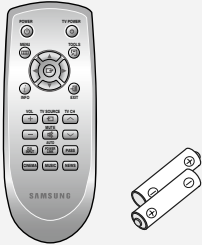
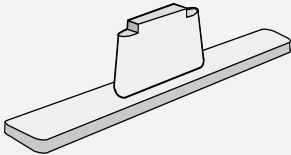
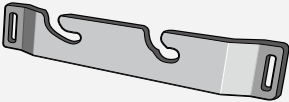
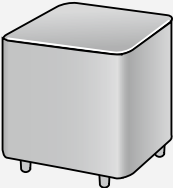
		
<p>Optical Cable (AH39-00779A)</p>	<p>User's Manual (AH68-02184R)</p>	<p>Remote Control / Batteries (AAA size) (AH59-02196A/ 4301-000116)</p>
		<p>< HT-WS1G/HT-WS1R only ></p> 
<p>Cradle stand (AH96-00044A)</p>	<p>Bracket-Wall Mount (AH61-02952A)</p>	<p>Wireless Subwoofer (PS-WWS1) (AH59-02215B)</p>





▪ The accessories may look slightly different than these.

safety information

SAFETY WARNINGS

TO REDUCE THE RISK OF ELECTRIC SHOCK, DO NOT REMOVE THE COVER(OR BACK). NO USER-SERVICEABLE PARTS ARE INSIDE. REFER SERVICING TO QUALIFIED SERVICE PERSONNEL.

	<div style="text-align: center;">CAUTION</div> <div style="text-align: center;">RISK OF ELECTRIC SHOCK DO NOT OPEN</div>	
<p>The lightning flash and Arrowhead within Triangle Is a warning sign alerting you of dangerous voltage Inside the product</p>	<p>CAUTION: TO REDUCE THE RISK OF ELECTRIC SHOCK, DO NOT REMOVE COVER (OR BACK) NO USER SERVICEABLE PARTS INSIDE. REFER SERVICING TO QUALIFIED SERVICE PERSONNEL.</p>	<p>The explanation point within the triangle is a warning sign alerting you of important instructions accompanying the product.</p>

**CLASS 1 LASER PRODUCT
KLASSE 1 LASER PRODUKT
LUOKAN 1 LASER LAITE
KLASS 1 LASER APPARAT
PRODUCTO LASER CLASE 1**

CLASS 1 LASER PRODUCT

This Compact Disc player is classified as a CLASS 1 LASER product. Use of controls, adjustments or performance of procedures other than those specified herein may result in hazardous radiation exposure.

CAUTION : INVISIBLE LASER RADIATION WHEN OPEN AND INTERLOCKS DEFEATED, AVOID EXPOSURE TO BEAM.

WARNING

- To reduce the risk of fire or electric shock, do not expose this appliance to rain or moisture.
- To prevent injury, this apparatus must be securely attached to the floor/wall in accordance with the installation instructions.

CAUTION

- Apparatus shall not be exposed to dripping or splashing and no objects filled with liquids, such as vases, shall be placed on the apparatus.
- The Mains plug is used as a disconnect device and shall stay readily operable at any time.

This product satisfies FCC regulations when shielded cables and connectors are used to connect the unit to other equipment. To prevent electromagnetic interference with electric appliances, such as radios and televisions, use shielded cables and connectors for connections.

FCC NOTE (for U.S.A):

This equipment has been tested and found to comply with the limits for a Class B digital device, pursuant to Part 15 of the FCC Rules. These limits are designed to provide reasonable protection against harmful interference in a residential installation.

This equipment generates, uses and can radiate radio frequency energy and, if not installed and used in accordance with the instructions, may cause harmful interference to radio communications. However, there is no guarantee that interference will not occur in a particular installation.

If this equipment does cause harmful interference to radio or television reception, which can be determined by turning the equipment off and on, the user is encouraged to try to correct the interference by one or more of the following measures:

- Reorient or relocate the receiving antenna.
- Increase the separation between the equipment and receiver.
- Connect the equipment into an outlet on a circuit different from that to which the receiver is connected.
- Consult the dealer or an experienced radio/TV technician for help.

Caution : FCC regulations state that any unauthorized changes or modifications to this equipment may void the user's authority to operate it.

Important Safety Instructions

Read these operating instructions carefully before using the unit. Follow all the safety instructions listed below. Keep these operating instructions handy for future reference.

- 1) Read these instructions.
- 2) Keep these Instructions.
- 3) Heed all warnings.
- 4) Follow all instructions.
- 5) Do not use this apparatus near water.
- 6) Clean only with dry cloth.
- 7) Do not block any ventilation openings. Install in accordance with the manufacturer's instructions.
- 8) Do not install near any heat sources such as radiators, heat registers, stoves, or other apparatus (including amplifiers) that produce heat.
- 9) Do not defeat the safety purpose of the polarized or grounding-type plug. A polarized plug has two blades with one wider than the other. A grounding type plug has two blades and a third grounding prong. The wide blade or the third prong are provided for your safety. If the provided plug does not fit into your outlet, consult an electrician for replacement of the obsolete outlet.
- 10) Protect the power cord from being walked on or pinched particularly at plugs, convenience receptacles, and the point where they exit from the apparatus.
- 11) Only use attachment/accessories specified by the manufacturer.
- 12) Use only with the cart, stand, tripod, bracket, or table specified by the manufacturer, or sold with the apparatus. When a cart is used, use caution when moving the cart/apparatus combination to avoid injury from tip-over.
- 13) Unplug this apparatus during lightning storms or when unused for long periods of time.
- 14) Refer all servicing to qualified service personnel. Servicing is required when the apparatus has been damaged in any way, such as power-supply cord or plug is damaged, liquid has been spilled or objects have fallen into the apparatus, the apparatus has been exposed to rain or moisture, does not operate normally, or has been dropped.



PRECAUTIONS

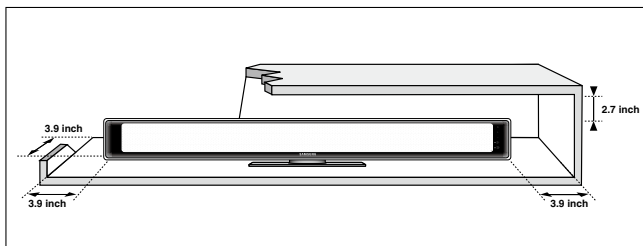

Ensure that the AC power supply in your house complies with the identification sticker located on the back of your product. Install your product horizontally, on a suitable base (furniture), with enough space around it for ventilation (3-4 inches). Make sure the ventilation slots are not covered. Do not place the unit on amplifiers or other equipment which may become hot. This unit is designed for continuous use. In order to disconnect the unit completely from the power supply, remove the main plug from the wall outlet, especially when left unused for a long period of time.

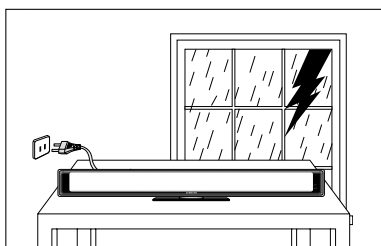

During thunderstorms, disconnect the AC main plug from the wall outlet. Voltage peaks due to lightning could damage the unit.

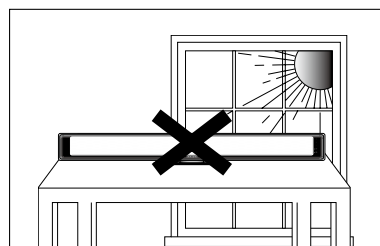

Do not expose the unit to direct sunlight or other heat sources. This could lead to overheating and malfunction of the unit.

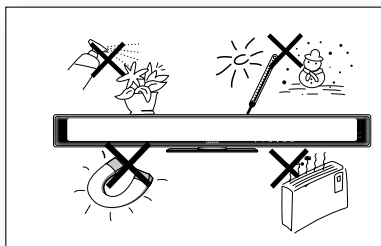

Protect the product from moisture (i.e. vases), and excess heat (e.g. fireplace) or equipment creating strong magnetic or electric fields. Disconnect the power cable from the AC supply if the unit malfunctions. Your product is not intended for industrial use. Use of this product is for personal use only.

Condensation may occur if your product or disc has been stored in cold temperatures. If transporting the unit during the winter, wait approximately 2 hours until the unit has reached room temperature before using.

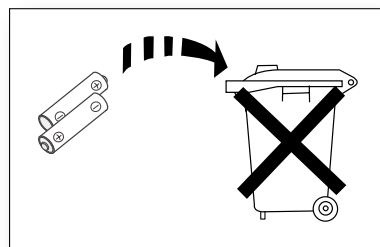

The batteries used with this product contain chemicals that are harmful to the environment. Do not dispose of batteries in the general household trash.

This product is covered by one or more of the following U.S. patents:

5,060,220	5,457,669	5,561,649	5,705,762	6,043,912	6,438,099	6,467,061	6,556,521	6,578,163	6,697,307	6,728,474
6,771,891	6,894,963	6,895,593	6,937,815	6,996,327	7,009,926	7,085,221	7,088,649	7,092,327	7,099,566	7,123,564
7,142,493	7,142,495	7,145,861	7,146,624	7,151,729	7,161,879	7,164,647	7,167,437	7,173,891	7,177,250	7,194,187
7,203,891	7,209,423	7,210,067	7,228,062	7,245,566	7,245,567	7,257,065	7,263,045	7,269,110	7,272,086	7,272,106
7,280,460	7,283,729	7,286,454	7,304,938							

This device is protected by U.S. Patent Nos:

6,836,549; 6,381,747; 7,050,698; 6,516,132; and 5,583,936.

contents



FEATURES	2	Features
	3	What's included
SAFETY INFORMATION	4	Safety warnings
	5	Precautions
GETTING STARTED	7	Before reading the user's manual
DESCRIPTIONS	8	Front panel
	9	Rear panel
REMOTE CONTROL	10	Tour of the remote control
CONNECTIONS	12	Installing the cradle stand
	12	Installing the wall mount
	13	Connecting the wireless subwoofer
	14	Connecting the Crystal Surround Air Track
FUNCTIONS	15	Basic functions
	15	Advanced functions
TROUBLESHOOTING	17	Troubleshooting
APPENDIX	18	Specifications

getting started

BEFORE READING THE USER'S MANUAL

Make sure to check the following terms before reading the user manual.

Icons that will be used in manual

Icon	Term	Definition
	Caution	This involves a case where a function does not operate or settings may be canceled.
	Note	This involves tips or instructions on the page that help each function operate.

About the use of this user's manual

- 1) Be sure to be familiar with Safety Instructions before using this product. (See page 4)
- 2) If a problem occurs, check the Troubleshooting. (See page 17)

Copyright

©2009 Samsung Electronics Co.,Ltd.

All rights reserved; No part or whole of this user's manual may be reproduced or copied without the prior written permission of Samsung Electronics Co.,Ltd.

descriptions

FRONT PANEL

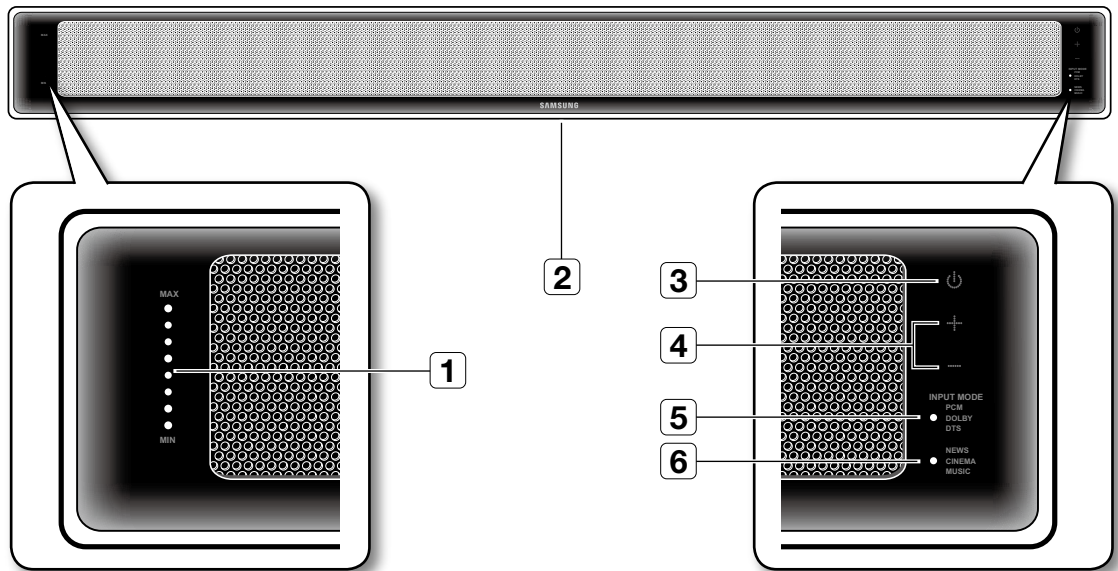

1	VOLUME LEVEL INDICATOR	Shows the current volume level. (The LED indicator lights in 8 steps, according to the volume level)
2	STANDBY LED	The standby LED lights up in standby mode. The standby LED turns off when the power of the unit turned on.
3	POWER BUTTON	Turns the Crystal Surround Air Track on and off.
4	VOLUME +/-	Controls the volume level.
5	INPUT MODE	Selects the Optical or Audio input.
6	SOUND FIELD MODE	Selects the sound field mode. (News, Cinema or Music)



- When you turn on the power of this unit, you will hear a click and there will be a 4 to 5 second delay before it can reproduce sound.

REAR PANEL

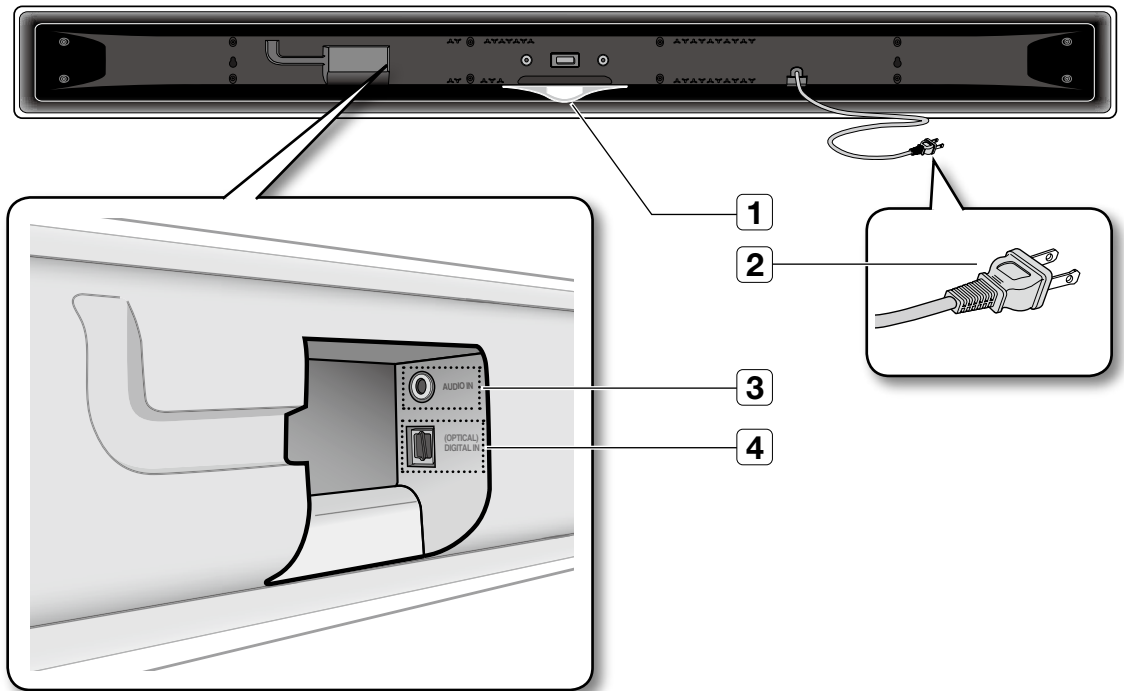

1	STANDBY LED	The standby LED lights up in standby mode. The standby LED turns off when the power of the unit is turned on.
2	POWER SUPPLY CABLE	Plug the power supply cable into the AC wall outlet.
3	AUDIO IN JACK	Connect to the analog output of an external device.
4	DIGITAL IN JACK	Connect to the digital (optical) output of an external device.



- When disconnecting the power cable from the wall outlet, hold the plug. Do not pull the cable.
- Do not connect this unit or other components to the main power until all connections between components are complete.

remote control

TOUR OF THE REMOTE CONTROL

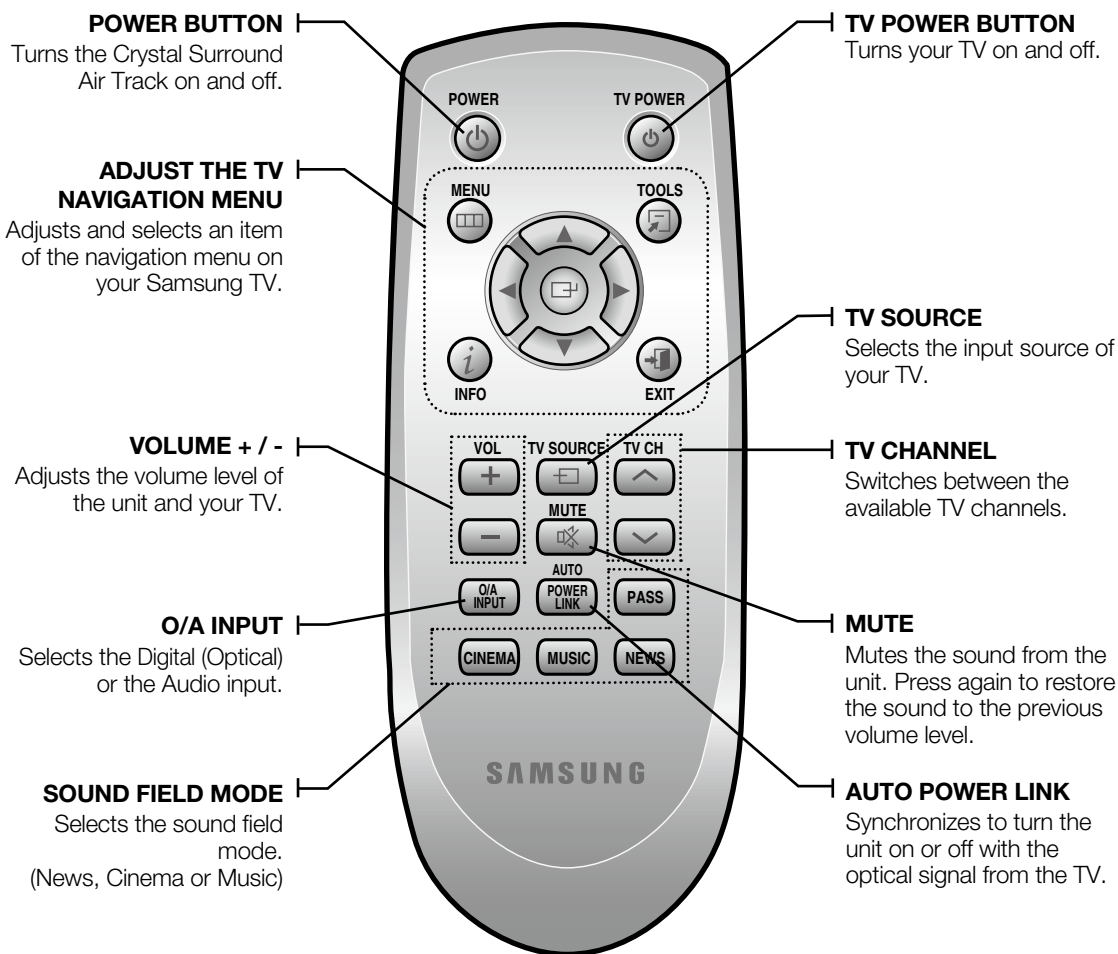

- The remote control can operate TVs made by SAMSUNG only.
- Depending on the TV you are using, you may not be able to operate your TV with this remote control. In this case, operate the TV using the TV's remote control.

Installing batteries in the Remote Control

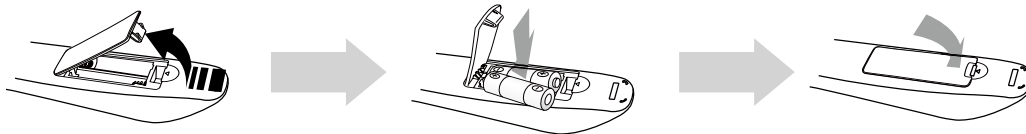

1. Lift the cover at the back of the remote control upward as shown.
2. Install two AAA size batteries. Make sure to match the “+” and “-” ends of the batteries with the diagram inside the compartment.
3. Replace the cover. Assuming typical TV usage, the batteries last for about one year.

Operation Range of the Remote Control

The remote control can be used up to approximately 23 feet (7 meters) in a straight line. It can also be operated at a horizontal angle of up to 30° from the remote control sensor.

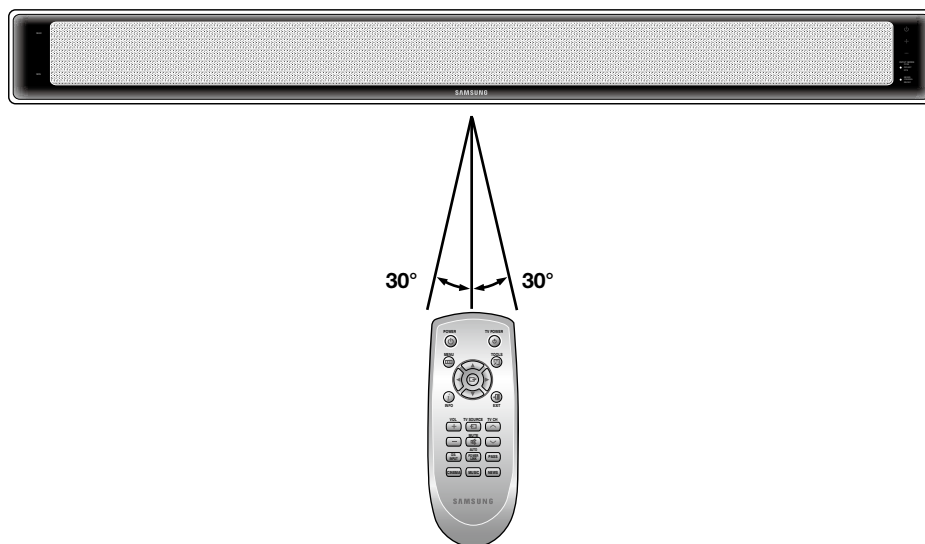

connections

INSTALLING THE CRADLE STAND

You can use the cradle stand to install this unit on a shelf. Make sure you place the unit on a flat surface.

CONNECTING

Slide the cradle stand into the speaker until you hear a click.

- Make sure the slot on the cradle stand is facing forward when connecting.

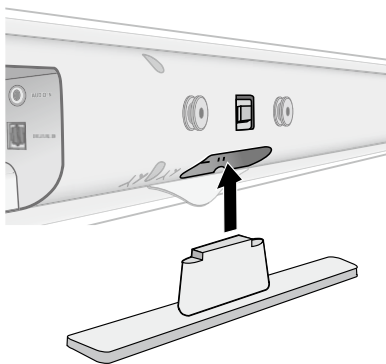

DISCONNECTING

Press the button to disconnect the cradle stand from the unit.

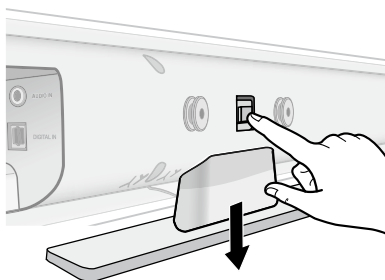

INSTALLING THE WALL MOUNT

You can use the wall mount bracket to mount this unit on the wall.

1. Place the wall mount bracket on a wall surface and then secure it with two screws (not supplied).
2. Then, fit the unit into the corresponding slots of the wall mount bracket. For secure installation, make sure the mounting studs slide firmly down into the bottom of the slots.
3. This is the completion of the suggested wall mount installation.

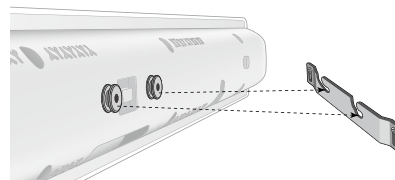
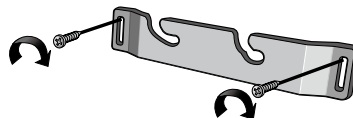

- Secure the unit firmly to the wall so that it does not fall off. If the unit falls off, it may result in an injury or damage to the product.
- When the unit is installed on a wall, please make sure that a child does not pull any of connecting cables, as it may cause it to fall.

CONNECTING THE WIRELESS SUBWOOFER (HT-WS1G/HT-WS1R ONLY)

The Subwoofer's linking ID is preset at the factory and the main unit and sub should link (connect wirelessly) automatically when turned on. If the link indicator does not light when main unit and subwoofer are turned on, please set the ID by following the process below.

1. Plug the power codes of the main unit and subwoofer into the AC power supply.
2. Press the ID SET button on the back of the subwoofer with a small pointed object for 3 seconds.
 - The STANDBY indicator is turned off and the LINK indicator (blue LED) blinks quickly.

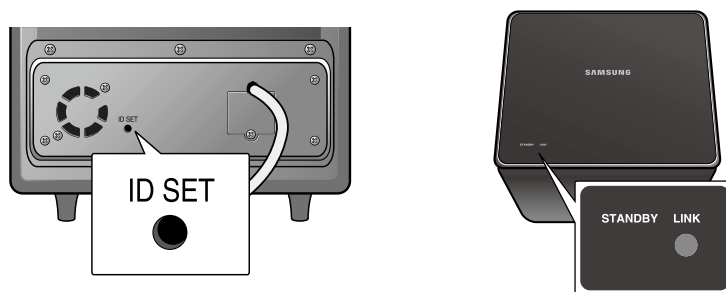

3. While main unit is powered off (STANDBY mode), press **MUTE** on the remote control for 5 seconds.
 - The volume Level Indicator on the main unit lights up, then returns to STANDBY mode.
4. Press the **POWER** button to turn on the main unit.
 - The main unit and the subwoofer are now linked (connected).
 - The Link indicator (blue LED) on the subwoofer is turned on.
 - You can enjoy better sound from the wireless subwoofer by selecting the sound field mode. (See page 16)

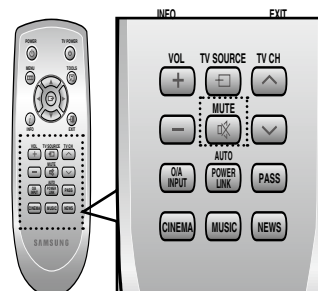

- Before moving or installing the product, be sure to turn off the power and disconnect the power cord.
- If the main unit is powered off, the wireless subwoofer will be in the standby mode and the STANDBY LED on the upper side will blink.
- If you use a device such as a microwave oven, wireless LAN Card, Bluetooth equipment, or any other device that uses the same frequency (2.4GHz) near the system, some sound interruption may be heard due to interference.
- The transmission distance of the wireless signal between the main unit and sub is about 32 feet, but may vary depending on your operating environment. If a steel-concrete or metallic wall is between main unit and the wireless subwoofer, the system may not operate at all, because the wireless signal cannot penetrate metal.
- If the main unit doesn't make wireless connection, follow steps 1-4 above to retry the connection between the main unit and wireless subwoofer.



- The wireless receiving antenna is built into the wireless subwoofer. Keep the unit away from water and moisture.
- For optimal listening performance, make sure that the area around the wireless subwoofer location is clear of any obstructions.

CONNECTING THE CRYSTAL SURROUND AIR TRACK

This section explains two ways (digital and analog) of connecting the unit to the TV.

This unit is equipped with one optical digital jack and one audio analog jack for connecting a TV.

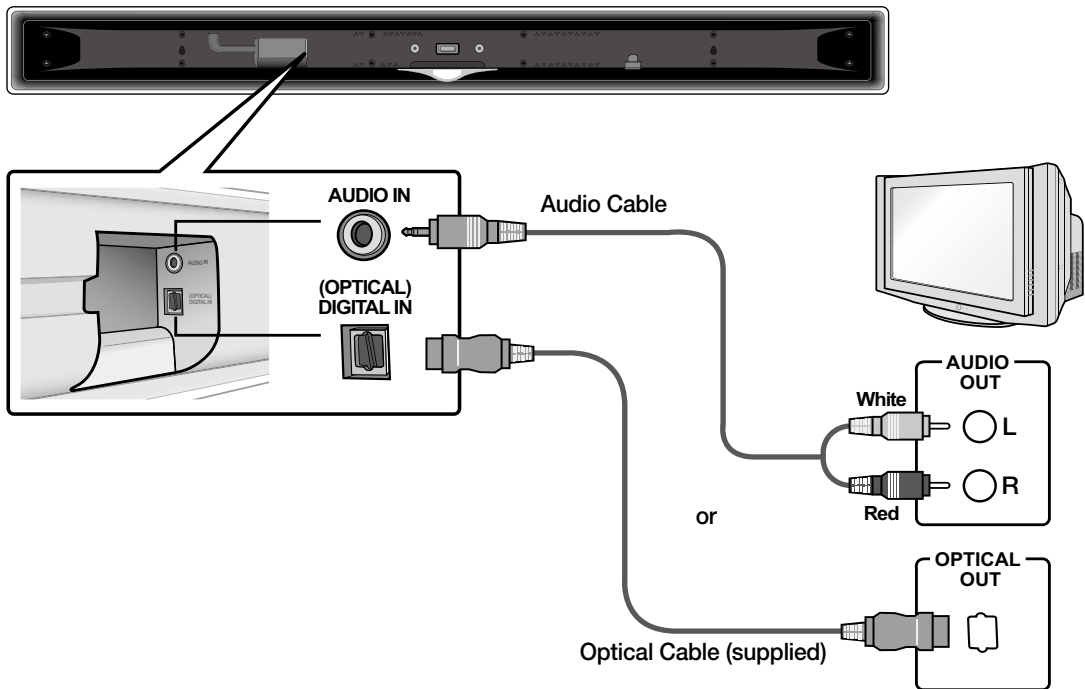

AUDIO IN

Connect **AUDIO IN** on the main unit to the **AUDIO OUT** of the TV.
Be sure to match connector colors.

OR,

DIGITAL IN (OPTICAL)

Connect the Digital Input on the main unit to the **OPTICAL OUT** of the TV.



- Do not connect the power cord of this product or your TV to the wall outlet until all connections between components are complete.
- Before moving or installing this product, be sure to turn off the power and disconnect the power cord.
- You can connect this unit to other external components. (such as DVD player, Set-Top Box etc.)

BASIC FUNCTIONS

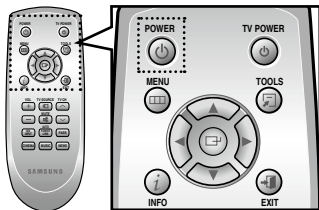

Turning the power on/off

1. Touch **POWER** (⏻) on the front panel.
OR,
Press **POWER** on the remote control to turn on the power.
 - The volume level appears in the front panel display.
2. Touch **POWER** (⏻) on the front panel.
OR,
Press **POWER** on the remote control again to turn off the power.

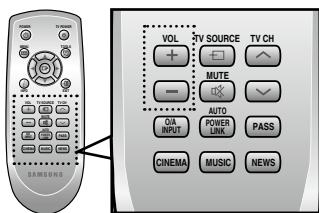

Adjusting the volume

Touch **VOLUME +/-** on the front panel.

OR,

Press **VOLUME +/-** on the remote control to increase or decrease the volume level.

- The numeric value of the volume level appears in the front panel display.



- The volume level increases or decreases when you press VOLUME +/-.
- If you want to enjoy the sound only from the Crystal Surround Air Track, select EXTERNAL AMPLIFIER in the AUDIO SETUP menu of the TV. Refer to the owner's manual supplied with your TV.

ADVANCED FUNCTIONS

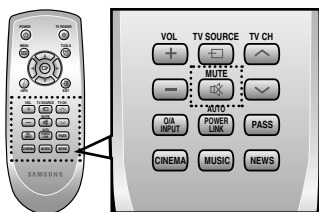

Muting the sound

This is useful when answering a doorbell or telephone call.

1. Press **MUTE** (⏻) on the remote control to mute the sound.
2. Press **MUTE** on the remote control again (or press **VOLUME +/-**) to restore the sound.



Selecting the input mode

You can select either Optical input or Audio input.

Press **O/A INPUT** on the remote control repeatedly to select the Digital (Optical) or Audio input.

Input mode		LED color
Digital input (Optical)	PCM	Red
	DOLBY	Green
	DTS	Blue
Audio input		Off



Using the sound field mode

You can select from three different sound field modes (NEWS, CINEMA and MUSIC) depending on the type of sources you want to enjoy. The color of the LED indicates sound field mode.

Sound field mode	LED color	Function
NEWS	Red	Press NEWS on the remote control when you play news sources.
CINEMA	Green	Press CINEMA on the remote control when you play movie sources.
MUSIC	Blue	Press MUSIC on the remote control when you play music sources.
PASS	Off	Press PASS on the remote control if you want to enjoy the original sound.

Using the AUTO POWER LINK function

If you turn the power of the TV on/off when the Crystal Surround Air Track is connected to your Samsung TV, the unit is also automatically turned on/off. (The unit will power off after 20 min.)

Press **AUTO POWER LINK** on the remote control of this unit.

- Auto power link function turns on and off each time you press **AUTO POWER LINK**.

AUTO POWER LINK	Standby LED
On	Standby LED will blink quickly 3 times.
Off	Standby LED will blink 1 time.



Using the TV functions

1. Press **TV POWER** on the remote control of this unit.
2. Press **TV CH** on the remote control to select the TV channel.
3. Press **VOLUME +/-** on the remote control to adjust the volume level of this unit.
4. Select one of the sound field mode buttons on the remote control to select the desired sound field mode.

- The remote control can operate TVs made by SAMSUNG only.

troubleshooting

Before requesting service, please check the following.

Symptom	Check	Remedy
The unit will not turn on.	<ul style="list-style-type: none"> • Is the power cord plugged into the outlet? 	<ul style="list-style-type: none"> • Connect the power plug to the outlet.
A function does not work when the button is pressed.	<ul style="list-style-type: none"> • Is there static electricity in the air? 	<ul style="list-style-type: none"> • Disconnect the power plug and connect it again.
Sound is not produced.	<ul style="list-style-type: none"> • Is the unit properly connected to your TV? • Is the Mute function on? • Is the volume set to minimum? 	<ul style="list-style-type: none"> • Connect it correctly. • Press Mute button to cancel the function. • Adjust the volume.
Picture does not appear on a TV when the function is selected.	<ul style="list-style-type: none"> • Is the TV connected properly? 	<ul style="list-style-type: none"> • Connect it correctly.
Remote control does not work.	<ul style="list-style-type: none"> • Are the batteries drained? • Is the distance between remote control and main unit too far? 	<ul style="list-style-type: none"> • Replace with new batteries. • Operate at a close distance.
The sound from the left/right channels is reversed.	<ul style="list-style-type: none"> • Are the left/right audio output cables from the TV connected properly? 	<ul style="list-style-type: none"> • Check the left/right channel and connect it/them correctly.

appendix

SPECIFICATIONS

GENERAL	Power supply		AC 120V, 60Hz
	Standby power consumption		0.9W
	Power consumption	Main unit	35W
		Subwoofer	35W
	Weight	Main unit	5.29 lbs
		Subwoofer	16.1lbs
	Dimensions (W x H x D)	Main unit	39.4 x 4.6 x 2.5 inches
		Subwoofer	11.4 x 14.6 x 11.6 inches
Operating temperature range		+41°F to +95°F	
Operating humidity range		10 % to 75 %	
AMPLIFIER	Rated output power	Main unit	80W/CH, 4Ω, THD = 10%, 1kHz
		Subwoofer	100W, 3Ω, THD = 10%, 120Hz
	Input sensitivity/Impedance		1800mV/47KΩ
	S/N ratio (analog input)		70dB
	Separation(1kHz)		60dB
FREQUENCY RESPONSE	Analog input		20Hz~20kHz(±3dB)
	Digital input/48kHz PCM		20Hz~20kHz(±3dB) ... based on TV

* S/N ratio, distortion, separation and usable sensitivity are based on measurement using AES (Audio Engineering Society) guidelines.

*: Nominal specification

- Samsung Electronics Co., Ltd reserves the right to change the specifications without notice.

- Weight and dimensions are approximate.

WARRANTY

LIMITED WARRANTY TO ORIGINAL PURCHASER

This SAMSUNG brand product, as supplied and distributed by Samsung Electronics America, Inc. (SAMSUNG) and delivered new, in the original carton to the original consumer purchaser, is warranted by SAMSUNG against manufacturing defects in materials and workmanship for a limited warranty period of:

One (1) Year Parts and Labor*
(*90 Days Parts and Labor for Commercial Use)

This limited warranty begins on the original date of purchase, and is valid only on products purchased and used in the United States. To receive warranty service, the purchaser must contact SAMSUNG for problem determination and service procedures. Warranty service can only be performed by a SAMSUNG authorized service center. The original dated bill of sale must be presented upon request as proof of purchase to SAMSUNG or SAMSUNG's authorized service center. Transportation of the product to and from the service center is the responsibility of the purchaser.

SAMSUNG will repair or replace this product, at our option and at no charge as stipulated herein, with new or reconditioned parts or products if found to be defective during the limited warranty period specified above. All replaced parts and products become the property of SAMSUNG and must be returned to SAMSUNG. Replacement parts and products assume the remaining original warranty, or ninety (90) days, whichever is longer.

SAMSUNG's obligations with respect to software products distributed by SAMSUNG under the SAMSUNG brand name are set forth in the applicable end user license agreement. Non-SAMSUNG hardware and software products, if provided, are on an "AS IS" basis. Non-SAMSUNG manufacturers, suppliers, publishers, and service providers may provide their own warranties.

This limited warranty covers manufacturing defects in materials and workmanship encountered in normal, and except to the extent otherwise expressly provided for in this statement, noncommercial use of this product, and shall not apply to the following, including, but not limited to: damage which occurs in shipment; delivery and installation; applications and uses for which this product was not intended; altered product or serial numbers; cosmetic damage or exterior finish; accidents, abuse, neglect, fire, water, lightning or other acts of nature; use of products, equipment, systems, utilities, services, parts, supplies, accessories, applications, installations, repairs, external wiring or connectors not supplied and authorized by SAMSUNG, or which damage this product or result in service problems; incorrect electrical line voltage, fluctuations and surges; customer adjustments and failure to follow operating instructions, cleaning, maintenance and environmental instructions that are covered and prescribed in the instruction book; product removal or reinstallation; reception problems and distortion related to noise, echo, interference or other signal transmission and delivery problems. SAMSUNG does not warrant uninterrupted or error-free operation of the product.

THERE ARE NO EXPRESS WARRANTIES OTHER THAN THOSE LISTED AND DESCRIBED ABOVE, AND NO WARRANTIES WHETHER EXPRESS OR IMPLIED, INCLUDING, BUT NOT LIMITED TO, ANY IMPLIED WARRANTIES OF MERCHANTABILITY OR FITNESS FOR A PARTICULAR PURPOSE, SHALL APPLY AFTER THE EXPRESS WARRANTY PERIODS STATED ABOVE, AND NO OTHER EXPRESS WARRANTY OR GUARANTY GIVEN BY ANY PERSON, FIRM OR CORPORATION WITH RESPECT TO THIS PRODUCT SHALL BE BINDING ON SAMSUNG. SAMSUNG SHALL NOT BE LIABLE FOR LOSS OF REVENUE OR PROFITS, FAILURE TO REALIZE SAVINGS OR OTHER BENEFITS, OR ANY OTHER SPECIAL, INCIDENTAL OR CONSEQUENTIAL DAMAGES CAUSED BY THE USE, MISUSE OR INABILITY TO USE THIS PRODUCT, REGARDLESS OF THE LEGAL THEORY ON WHICH THE CLAIM IS BASED, AND EVEN IF SAMSUNG HAS BEEN ADVISED OF THE POSSIBILITY OF SUCH DAMAGES. NOR SHALL RECOVERY OF ANY KIND AGAINST SAMSUNG BE GREATER IN AMOUNT THAN THE PURCHASE PRICE OF THE PRODUCT SOLD BY SAMSUNG AND CAUSING THE ALLEGED DAMAGE. WITHOUT LIMITING THE FOREGOING, PURCHASER ASSUMES ALL RISK AND LIABILITY FOR LOSS, DAMAGE OR INJURY TO PURCHASER AND PURCHASER'S PROPERTY AND TO OTHERS AND THEIR PROPERTY ARISING OUT OF THE USE, MISUSE OR INABILITY TO USE THIS PRODUCT SOLD BY SAMSUNG NOT CAUSED DIRECTLY BY THE NEGLIGENCE OF SAMSUNG. THIS LIMITED WARRANTY SHALL NOT EXTEND TO ANYONE OTHER THAN THE ORIGINAL PURCHASER OF THIS PRODUCT, IS NONTRANSFERABLE AND STATES YOUR EXCLUSIVE REMEDY.

Some states do not allow limitations on how long an implied warranty lasts, or the exclusion or limitation of incidental or consequential damages, so the above limitations or exclusions may not apply to you. This warranty gives you specific legal rights, and you may also have other rights which vary from state to state.

To obtain warranty hardware service, please contact SAMSUNG at:

Samsung Electronics America, Inc.
105 Challenger Road Ridgefield Park, NJ 07660-0511
1-800-SAMSUNG (726-7864) and www.samsung.com/us

Contact SAMSUNG WORLD WIDE

If you have any questions or comments relating to Samsung products, please contact the SAMSUNG customer care center.

Region	Country	Customer Care Center	Web Site
North America	CANADA	1-800-SAMSUNG(726-7864)	www.samsung.com/ca
	MEXICO	01-800-SAMSUNG(726-7864)	www.samsung.com/mx
	U.S.A	1-800-SAMSUNG(726-7864)	www.samsung.com/us
Latin America	ARGENTINE	0800-333-3733	www.samsung.com/ar
	BRAZIL	0800-124-421, 4004-0000	www.samsung.com/br
	CHILE	800-SAMSUNG(726-7864)	www.samsung.com/cl
	NICARAGUA	00-1800-5077267	www.samsung.com/latin
	HONDURAS	800-7919267	www.samsung.com/latin
	COSTA RICA	0-800-507-7267	www.samsung.com/latin
	ECUADOR	1-800-10-7267	www.samsung.com/latin
	EL SALVADOR	800-6225	www.samsung.com/latin
	GUATEMALA	1-800-299-0013	www.samsung.com/latin
	JAMAICA	1-800-234-7267	www.samsung.com/latin
	PANAMA	800-7267	www.samsung.com/latin
	PUERTO RICO	1-800-682-3180	www.samsung.com/latin
	REP. DOMINICA	1-800-751-2676	www.samsung.com/latin
	TRINIDAD & TOBAGO	1-800-SAMSUNG(726-7864)	www.samsung.com/latin
VENEZUELA	0-800-100-5303	www.samsung.com/latin	
COLOMBIA	01-8000112112	www.samsung.com.co	
Europe	BELGIUM	02 201 2418	www.samsung.com/be (Dutch) www.samsung.com/be_fr (French)
	CZECH REPUBLIC	800-SAMSUNG(800-726786)	www.samsung.com/cz
	DENMARK	8-SAMSUNG(7267864)	www.samsung.com/dk
	FINLAND	30-6227 515	www.samsung.com/fi
	FRANCE	01 4863 0000	www.samsung.com/fr
	GERMANY	01805 - SAMSUNG(726-7864 € 0,14/Min)	www.samsung.de
	HUNGARY	06-80-SAMSUNG(726-7864)	www.samsung.com/hu
	ITALIA	800-SAMSUNG(726-7864)	www.samsung.com/it
	LUXEMBURG	02 261 03 710	www.samsung.com/lu
	NETHERLANDS	0900-SAMSUNG (0900-7267864) (€ 0,10/Min)	www.samsung.com/nl
	NORWAY	3-SAMSUNG(7267864)	www.samsung.com/no
	POLAND	0 801 1SAMSUNG(172678), 022-607-93-33	www.samsung.com/pl
	PORTUGAL	80820-SAMSUNG(726-7864)	www.samsung.com/pt
	SLOVAKIA	0800-SAMSUNG(726-7864)	www.samsung.com/sk
	SPAIN	902-1-SAMSUNG (902 172 678)	www.samsung.com/es
	SWEDEN	075-SAMSUNG(726 78 64)	www.samsung.com/se
	U.K	0845 SAMSUNG (7267864)	www.samsung.com/uk
	EIRE	0818 717 100	www.samsung.com/ie
	AUSTRIA	0810-SAMSUNG(7267864, € 0,07/min)	www.samsung.com/at
SWITZERLAND	0848-SAMSUNG(7267864, CHF 0.08/min)	www.samsung.com/ch	
CIS	RUSSIA	8-800-555-55-55	www.samsung.ru
	KAZAHSTAN	8-10-800-500-55-500	www.samsung.com/kz_ru
	UZBEKISTAN	8-10-800-500-55-500	www.samsung.com/kz_ru
	KYRGYZSTAN	00-800-500-55-500	
	TADJIKISTAN	8-10-800-500-55-500	
	UKRAINE	8-800-502-0000	www.samsung.ua
	LITHUANIA	8-800-77777	www.samsung.com/lt
	LATVIA	8000-7267	www.samsung.com/lv
	ESTONIA	800-7267	www.samsung.com/ee
Asia Pacific	AUSTRALIA	1300 362 603	www.samsung.com/au
	NEW ZEALAND	0800 SAMSUNG (0800 726 786)	www.samsung.com/nz
	CHINA	800-810-5858, 400-810-5858, 010-6475 1880	www.samsung.com/cn
	HONG KONG	3698-4698	www.samsung.com/hk
	INDIA	3030 8282, 1800 110011, 1-800-3000-8282	www.samsung.com/in
	INDONESIA	0800-112-8888	www.samsung.com/id
	JAPAN	0120-327-527	www.samsung.com/jp
	MALAYSIA	1800-88-9999	www.samsung.com/my
	PHILIPPINES	1-800-10-SAMSUNG(726-7864) 1-800-3-SAMSUNG(726-7864), 02-5805777	www.samsung.com/ph
	SINGAPORE	1800-SAMSUNG(726-7864)	www.samsung.com/sg
	THAILAND	1800-29-3232, 02-689-3232	www.samsung.com/th
TAIWAN	0800-329-999	www.samsung.com/tw	
VIETNAM	1 800 588 889	www.samsung.com/vn	
Middle East & Africa	TURKEY	444 77 11	www.samsung.com/tr
	SOUTH AFRICA	0860-SAMSUNG(726-7864)	www.samsung.com/za
	U.A.E	800-SAMSUNG (726-7864), 8000-4726	www.samsung.com/ae



QUESTIONS OR COMMENTS?

COUNTRY	CALL	OR VISIT US ONLINE AT	WRITE
IN THE US	1-800-SAMSUNG (7267864)	www.samsung.com/us	Samsung Electronics America, Inc. 105 Challenger Road Ridgefield Park, NJ 07660-0511

Free Manuals Download Website

<http://myh66.com>

<http://usermanuals.us>

<http://www.somanuals.com>

<http://www.4manuals.cc>

<http://www.manual-lib.com>

<http://www.404manual.com>

<http://www.luxmanual.com>

<http://aubethermostatmanual.com>

Golf course search by state

<http://golfingnear.com>

Email search by domain

<http://emailbydomain.com>

Auto manuals search

<http://auto.somanuals.com>

TV manuals search

<http://tv.somanuals.com>