

SAMSUNG

Digital Surround AV Receiver System *HT-AS720S*

SAMSUNG

SAMSUNG ELECTRONICS CANADA, INC.

HEADQUARTERS

55 Standish Court Mississauga, Ontario L5R 4B2 Canada

TEL: 1-905-542-3535

www.samsung.ca

SERVICE DIVISION

55 Standish Court Mississauga, Ontario L5R 4B2 Canada

1-800-SAMSUNG (1-800-726-7864)

Instruction Manual

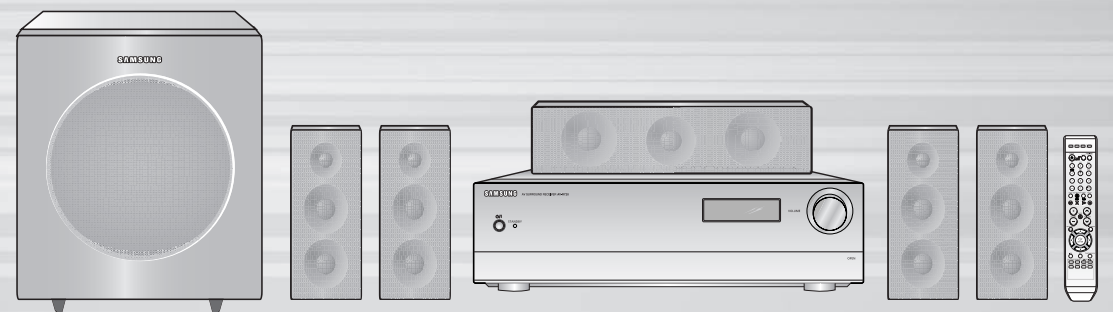



Safety Warnings



Precautions

CAUTION
RISK OF ELECTRIC SHOCK.
DO NOT OPEN

CAUTION:
TO REDUCE THE RISK OF ELECTRIC SHOCK,
DO NOT REMOVE REAR COVER.
NO USER SERVICEABLE PARTS INSIDE.
SERVICE PERSONNEL.

Note to CATV system installer :
This reminder is provided to call the CATV system installer's attention to Section 820~40 of the NEC which provides guidelines for proper grounding and, in particular, specifies that the cable ground shall be connected to the grounding system of the building, as close to the point of cable entry as practical.

- This symbol indicates that dangerous voltage which can cause electric shock is present inside this unit.
- This symbol alerts you to important operating and maintenance instructions accompanying the unit.

WARNING : To reduce the risk of fire or electric shock, do not expose this appliance to rain or moisture.

CAUTION : TO PREVENT ELECTRIC SHOCK, MATCH WIDE BLADE OF PLUG TO WIDE SLOT, FULLY INSERT.

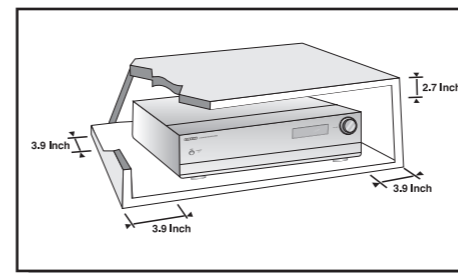

Ensure that the AC power supply in your house complies with the identification sticker located on the back of your player. Install your player horizontally, on a suitable base (furniture), with enough space around it for ventilation (3~4inches). Make sure the ventilation slots are not covered. Do not stack anything on top of the amplifier. In order to disconnect the player completely from the power supply, remove the mains plug from the wall outlet, especially when left unused for a long period of time.

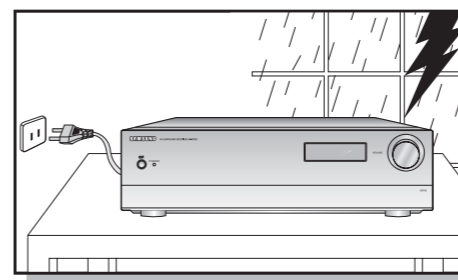
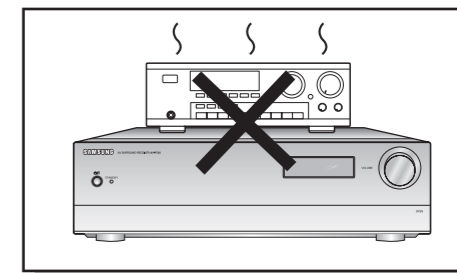

During thunderstorms, disconnect AC main plug from the wall outlet. Voltage peaks due to lightning could damage the unit.

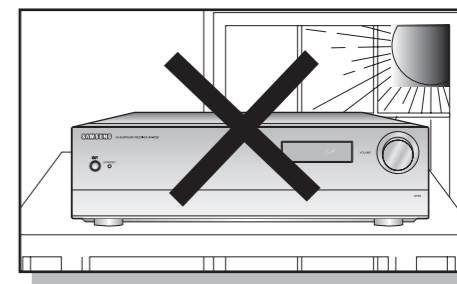

Do not expose the unit to direct sunlight or other heat sources. This could lead to overheating and malfunction of the unit.

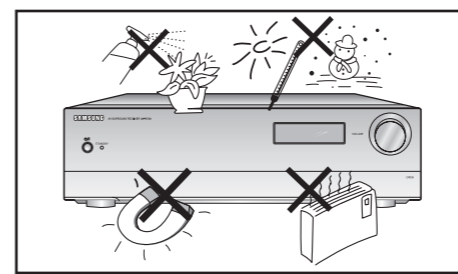

Protect the player from moisture (i.e. vases), and excess heat (e.g. fireplace) or equipment creating strong magnetic or electric fields (i.e. speakers...). Disconnect the power cable from the AC supply if the player malfunctions. Your player is not intended for industrial use. Use of this product is for personal use only. Condensation may occur if your player or disc have been stored in cold temperatures. If transporting the player during the winter, wait approximately 2 hours until the unit has reached room temperature before using.

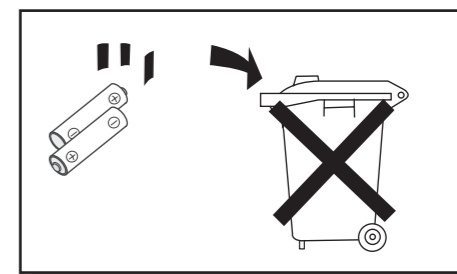

The battery used with this product contains chemicals that are harmful to the environment. Do not dispose of batteries in the general household trash.



Features

- Digital AV Receiver**
 This product is a pure digital AV receiver that performs digital signal processing to minimize signal distortion and loss.
- Dolby Pro Logic IIx**
 Dolby Pro Logic IIx is a new technology that provides discrete 7.1 channel out of 2 channel or multi channel sources. It also provides Music, Movie and Game modes.
- DTS 96/24**
 DTS is a surround format that implements 5.1 channel multi channel sound at 96KHz/24bit. In addition, it can also reproduce the matrix 6.1 of DTS 96/24 decoder signals.
- DOLBY DIGITAL EX**
 Adds a surround back channel for more spacious sound compared to regular 5.1 channel Dolby Digital.
- DTS (Digital Theater Systems)**
 DTS plays back 5.1 channel sound with less compression than Dolby Digital for richer sound.
- DTS-ES (Extended Surround)**
 DTS-ES adds an additional rear center surround channel for 6.1 channel sound. It is compatible with existing DTS Digital Sound formats.
- DTS NEO:6**
 Reproduces digital PCM or analog stereo over 6.1 channels using a high precision DTS digital matrix.
- SFE (Sound Field Effect) Using 24bit Audio Digital Signal Processing**
 Provides more realistic surround sound with normal stereo audio sources.
- Anynet+ (HDMI-CEC) Function**
 Anynet+ is a function that can be used to operate this AV Receiver with a Samsung TV remote control, by connecting the receiver to a SAMSUNG TV using an HDMI Cable. (This function is available only in connection with Samsung TV and DVD player supporting Anynet+(HDMI-CEC).)



Contents

- PREPARATION**

 - Safety Warnings 2
 - Precautions..... 3
 - Features 4
 - Description 6
- CONNECTIONS**

 - Connecting speakers 10
 - Connecting external devices 12
 - Anynet+ 16
 - Connecting the FM antenna 17
- OPERATION**

 - Before using the AV receiver 18
 - Selecting digital/analog input 19
 - Setting the speaker mode..... 20
 - Setting the speaker listening distance 22
 - Setting digital input 23
 - Setting HDMI AUDIO 24
 - Setting DRC (Dynamic Range Compression) 25
 - Test tone 26
 - Setting speaker level 28
 - Dolby Pro Logic IIx mode 29
 - Setting Dolby Pro Logic IIx effect 30
 - Setting NEO:6 mode..... 31
 - Setting EX/ES mode..... 32
 - Setting Tone Control..... 33
 - SFE mode..... 34
 - Stereo mode 35
- RADIO OPERATION**

 - Listening to radio 36
 - Presetting radio stations 37
- MISCELLANEOUS**

 - Convenient functions 38
 - Operating your TV with the remote control..... 41
 - Operating your DVD or VCR with the remote control 43
 - Before calling for service 45
 - Specifications 47



Description

[Front panel]

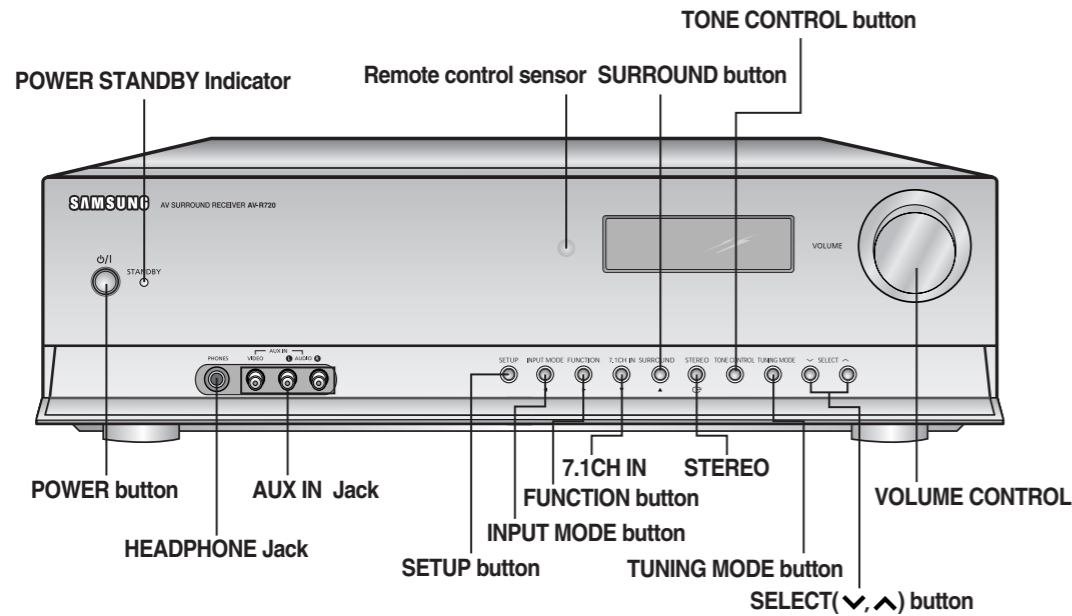

[Display]

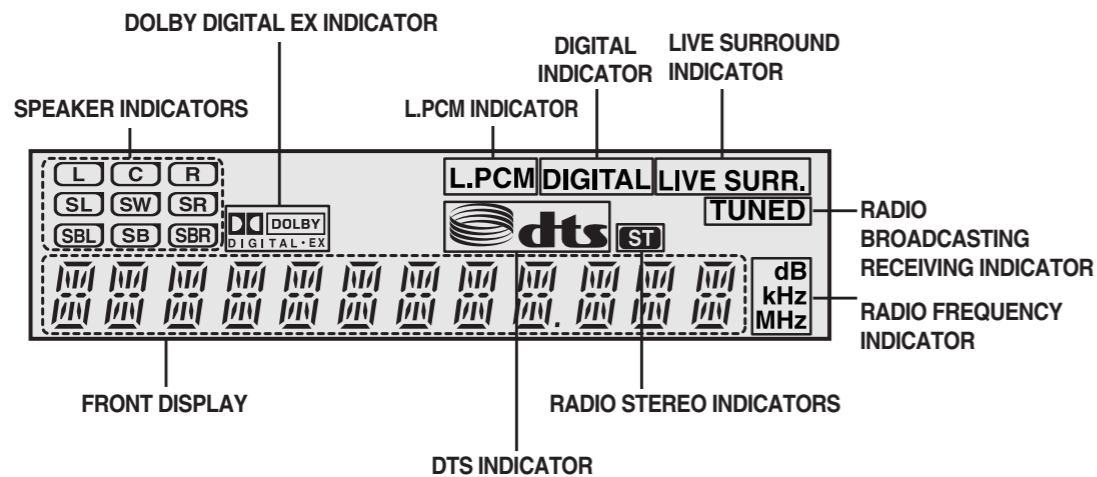

[Rear panel]

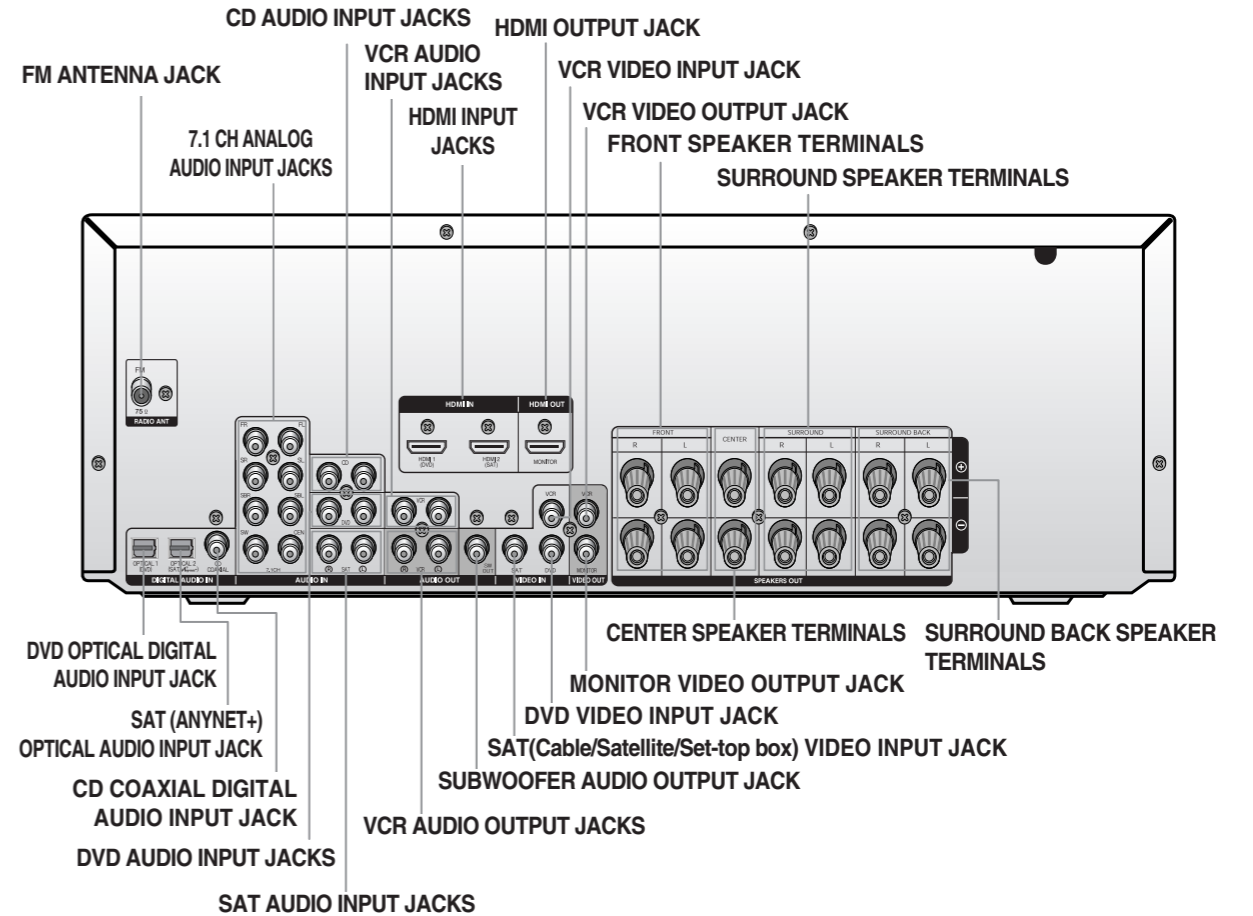

▶▶ Accessories ◀◀

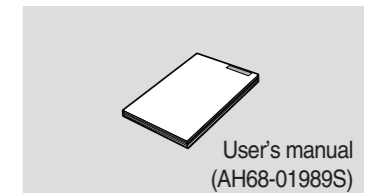



Description (Cont'd)

[Remote control]

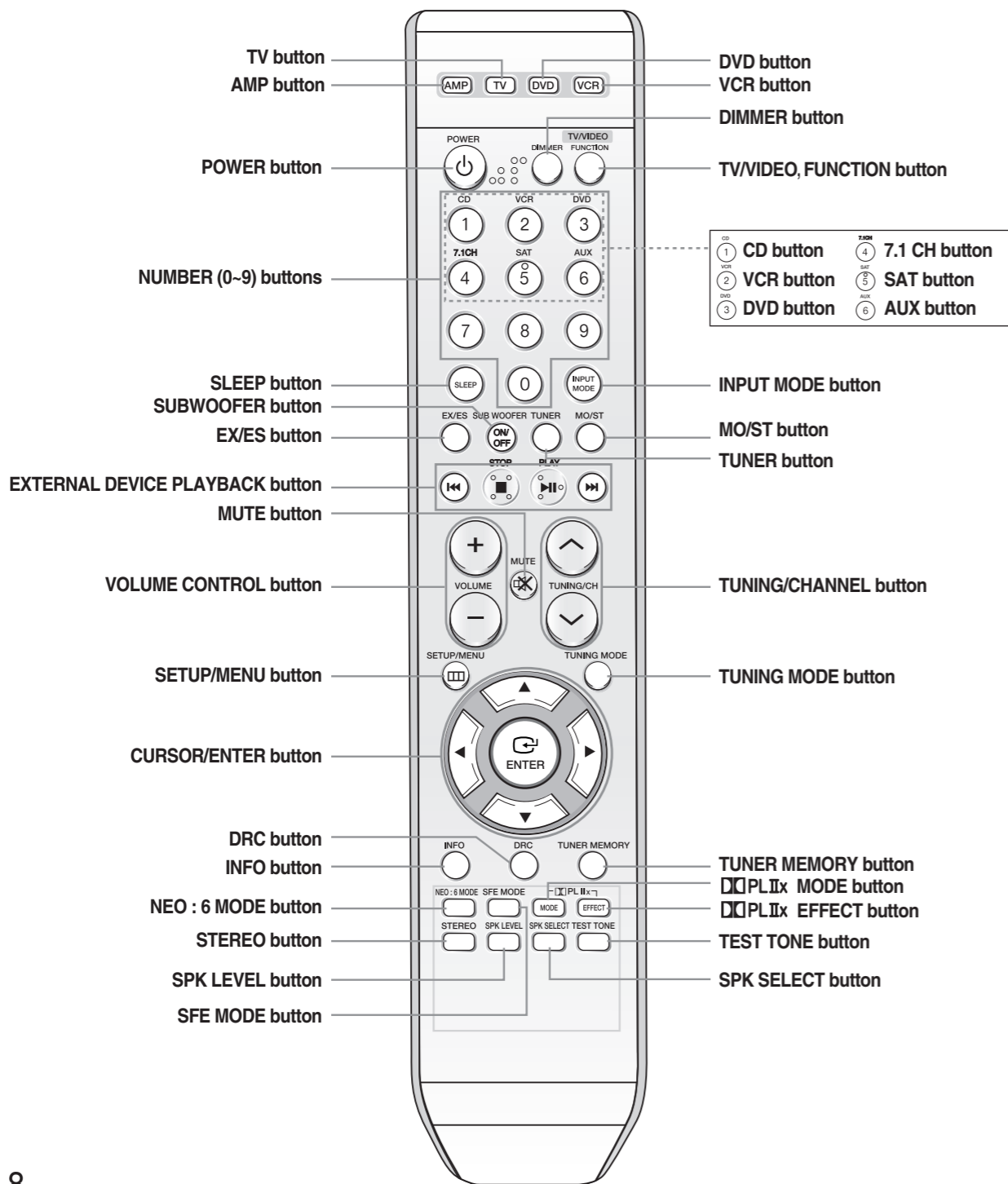

Insert remote control batteries

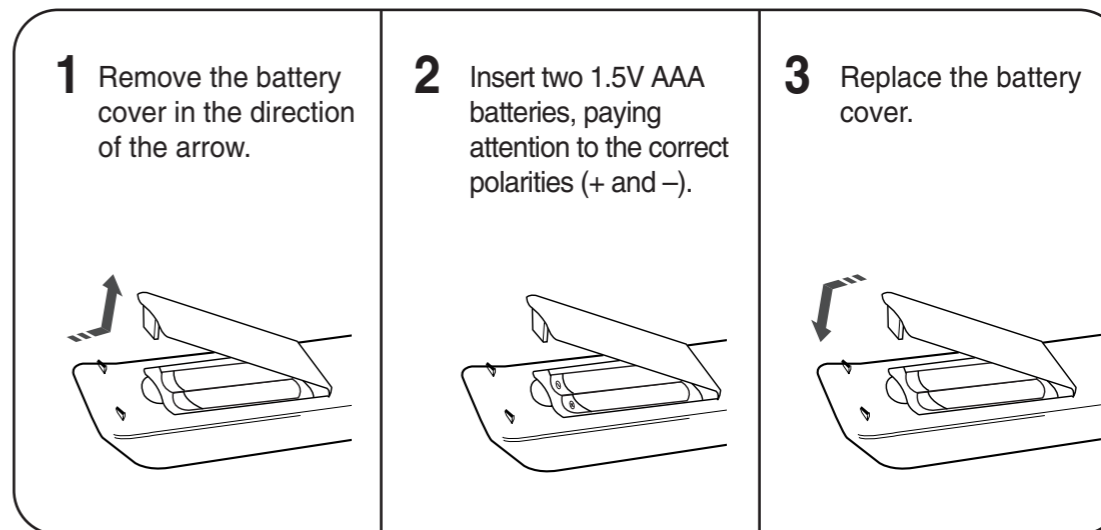

- Note**
- Follow these precautions to avoid leaking or cracking batteries:**
- Place batteries in the remote control so they match the polarity:(+) to (+)and (-)to (-).
 - Use the correct type of batteries. Batteries that look similar may differ in voltage.
 - Always replace both batteries at the same time.
 - Do not expose batteries to heat or flame.

Range of operation of the remote control

The remote control can be used up to approximately 23 feet/7 meters in a straight line. It can also be operated at a horizontal angle of up to 30° from the remote control sensor.

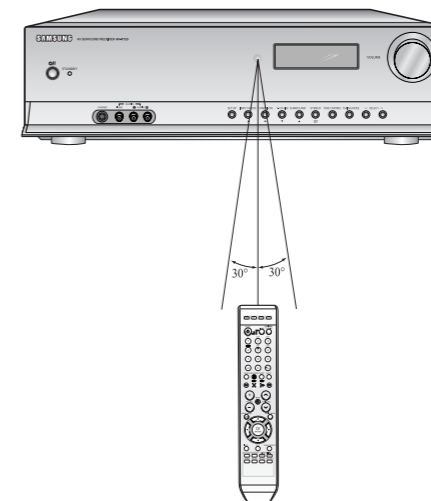



Connecting speakers

Before moving or installing the product, be sure to turn off the power and disconnect the power cord.

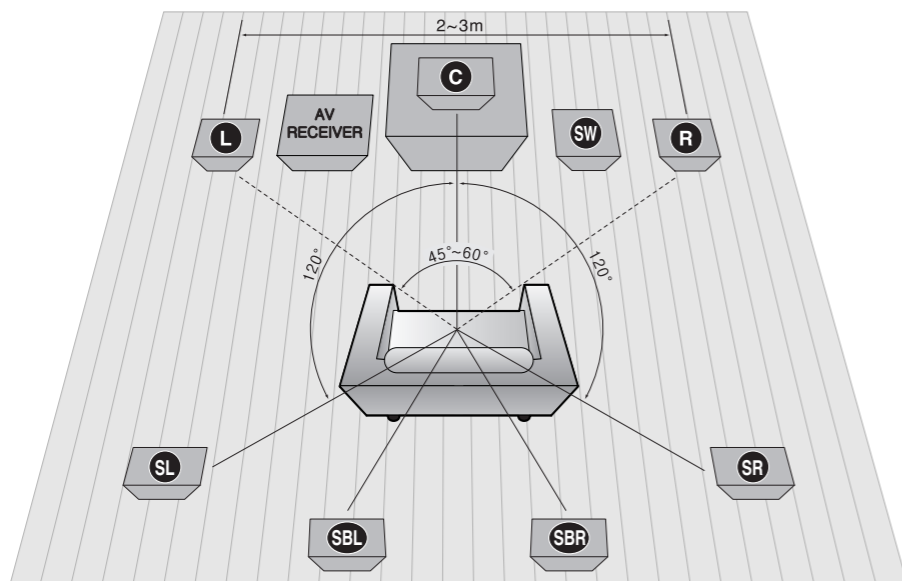

Position of AV Receiver

- Place AV Receiver on a dedicated stand or rack.

Front Speakers L R

- Place these speakers in front of your listening position, facing inwards (about 45°) toward you.
- Place the speakers so that their tweeters will be at the same height as your ears.
- Align the front face of the front speakers with the front face of the center speaker or place them slightly in front of the center speaker.

Center speaker C

- It is best to install it at the same height as the front speakers.
- You can also install it directly over or under the TV.

Subwoofer SW

- The position of the subwoofer is not so critical. Place it anywhere you like.

Surround Speakers SL SR

- Place these speakers behind your listening position.
- If there isn't enough room, place these speakers so they face each other.
- Place them about 60 to 90cm (2 to 3feet) above your ears, facing slightly downward.
- Unlike the front and center speakers, the surround speakers are used to handle mainly sound effects and sound will not come from them all the time.

Surround Back Speakers SBL SBR

- If you are using two rear center speakers, place them facing forward from behind the listening position.
- Place the surround back speaker about 70 cm to 1 m (2.3-3.3feet) above surround speakers, facing slightly downwards.

Note When you attach the speakers to a wall, make sure to fasten them tightly so they do not fall off.

Subwoofer function

Active subwoofer with integrated 150W amplifier provides rich bass sound.

- Connect the SW OUT terminal of the amplifier (AV-R720) to the INPUT terminal of the subwoofer speaker.
- Press the POWER button on the rear side of the subwoofer to turn the power on.
- Using the subwoofer's VOLUME control, you can set the desired bass level (See page 30 "Setting Speaker Level" to set the subwoofer level in the menu).

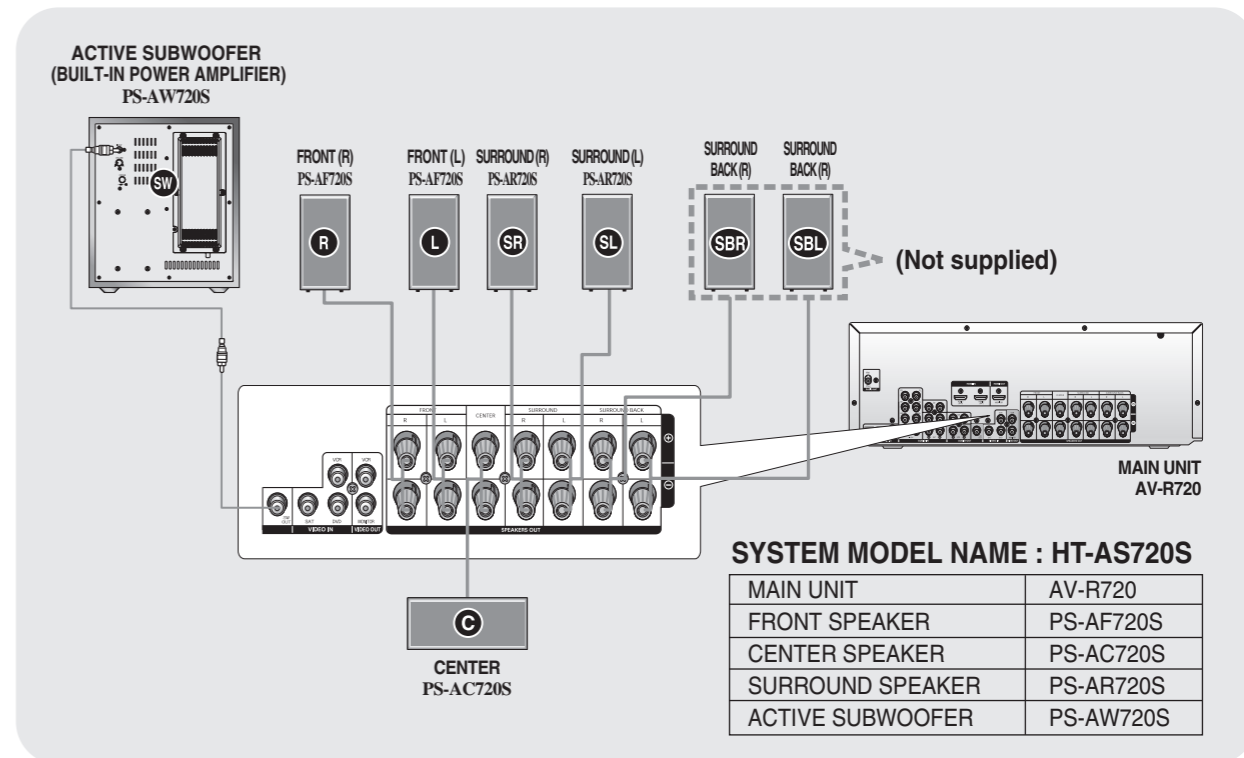
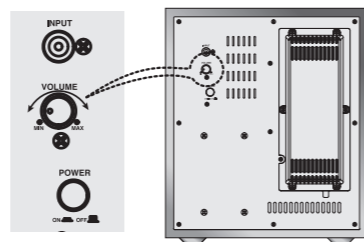

CONNECTING SPEAKER WIRE

- Loosen the knob by turning counterclockwise.
- Insert the bare part of the wire into the hole in the side of each terminal.
- Tighten the knob by turning clockwise to secure the wire.

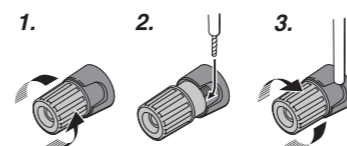

Connecting the Speakers

- Press down the terminal tab on the back of the speaker.
- Insert the black wire into the black terminal (-) and the red wire into the red (+) terminal, and then release the tab.
- Connect the connecting plugs to the back of the Home Theater.
 - Make sure the colors of the speaker terminals match the colors of the connecting plugs.

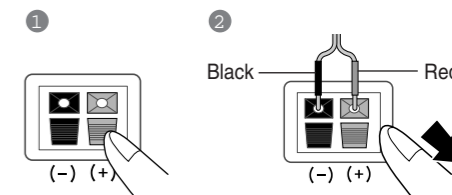

Caution

- Keep the subwoofer speaker out of reach of children to prevent them from inserting their hands or objects into the duct (hole).

Note

- Never touch speaker terminals while the power is on. Doing so could result in electric shock.
- Make sure the polarities (+ and -) are correct.
- This system is capable of reproducing 6.1/7.1 channel sound, however only 5.1 speakers are supplied.



Connecting external devices

Connecting video devices

Before moving or installing the product, be sure to turn off the power and disconnect the power cord.

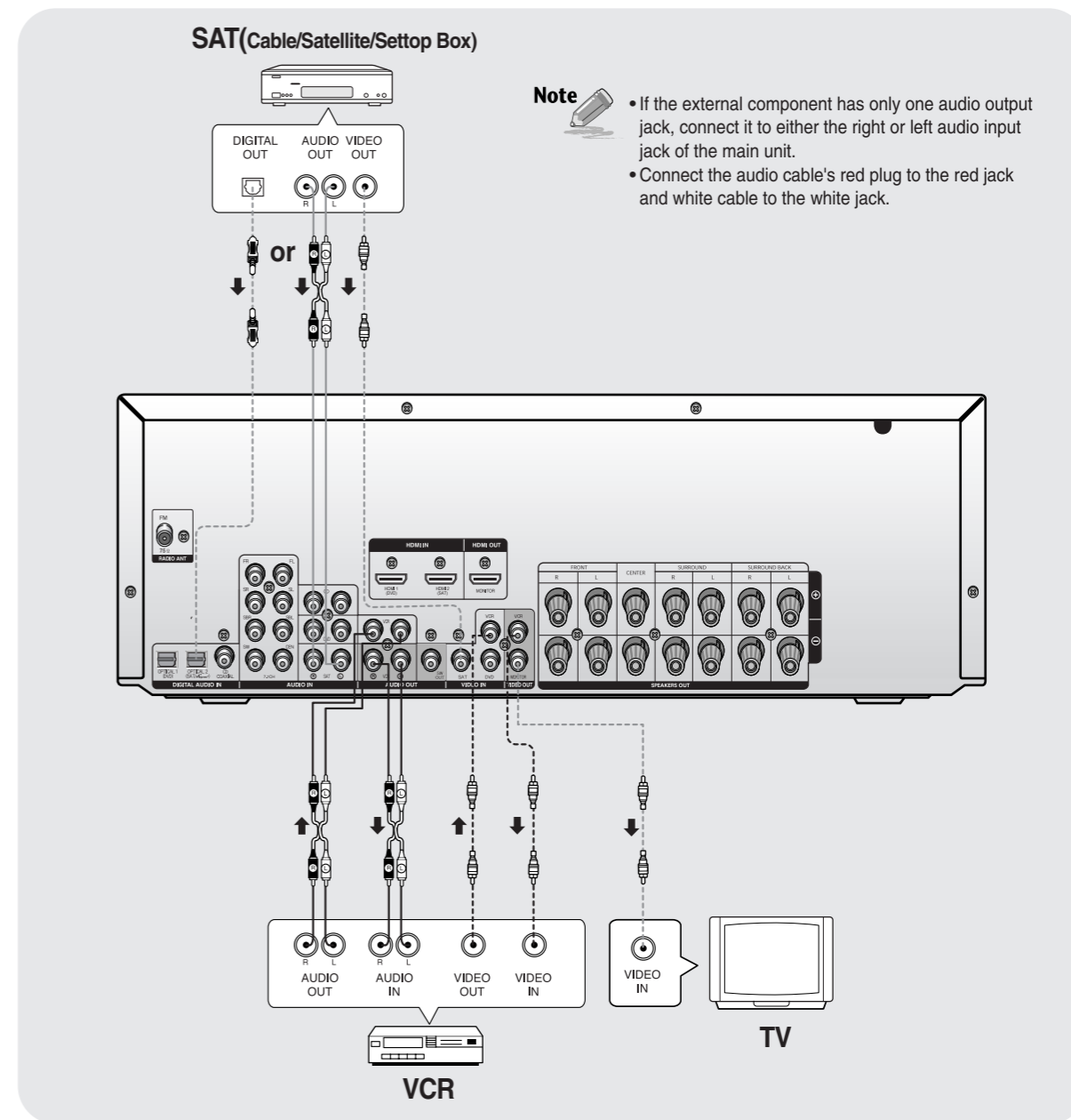
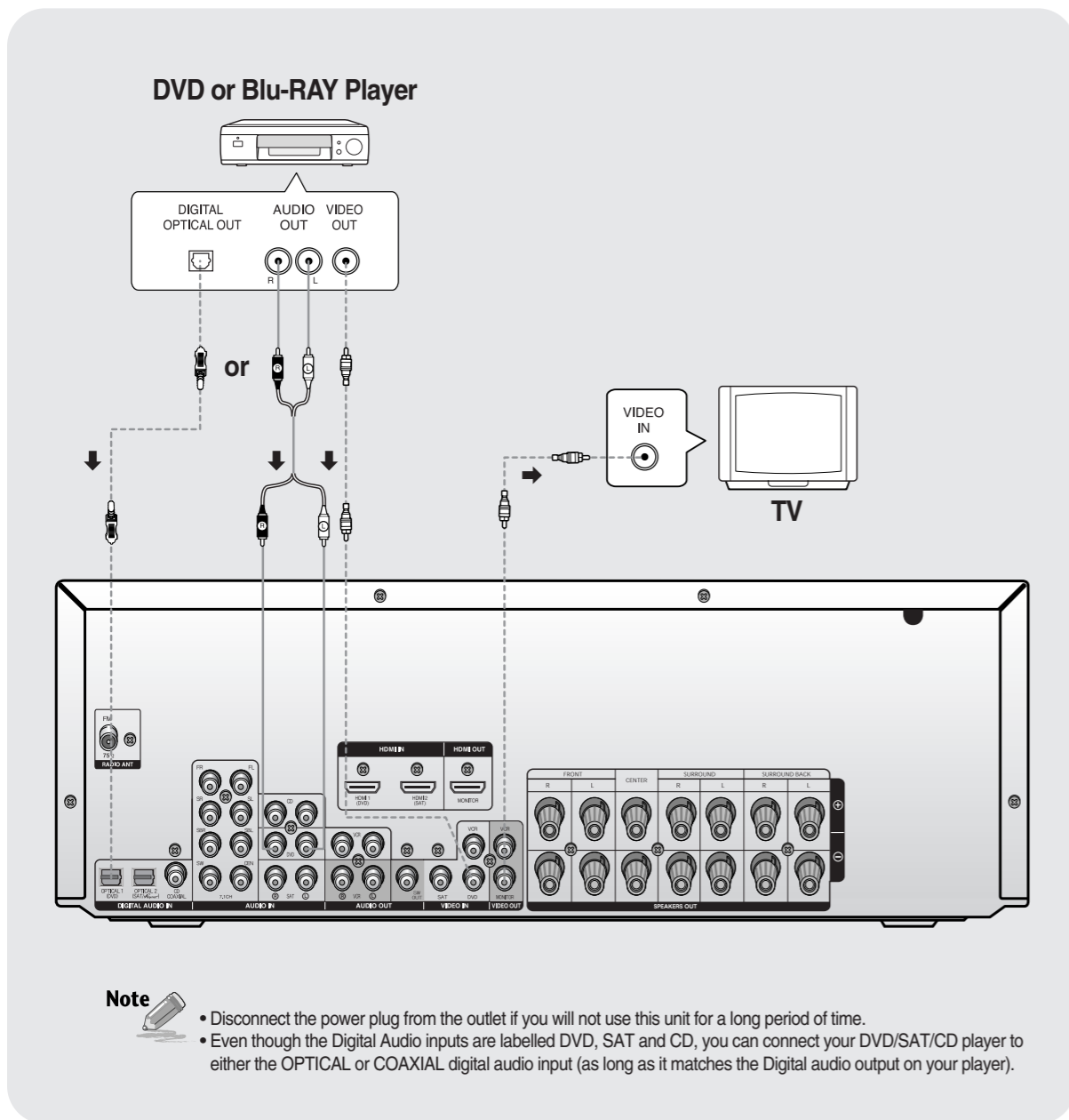



Connecting external devices (Cont'd)

Connecting audio/7.1 channel devices

Before moving or installing the product, be sure to turn off the power and disconnect the power cord.

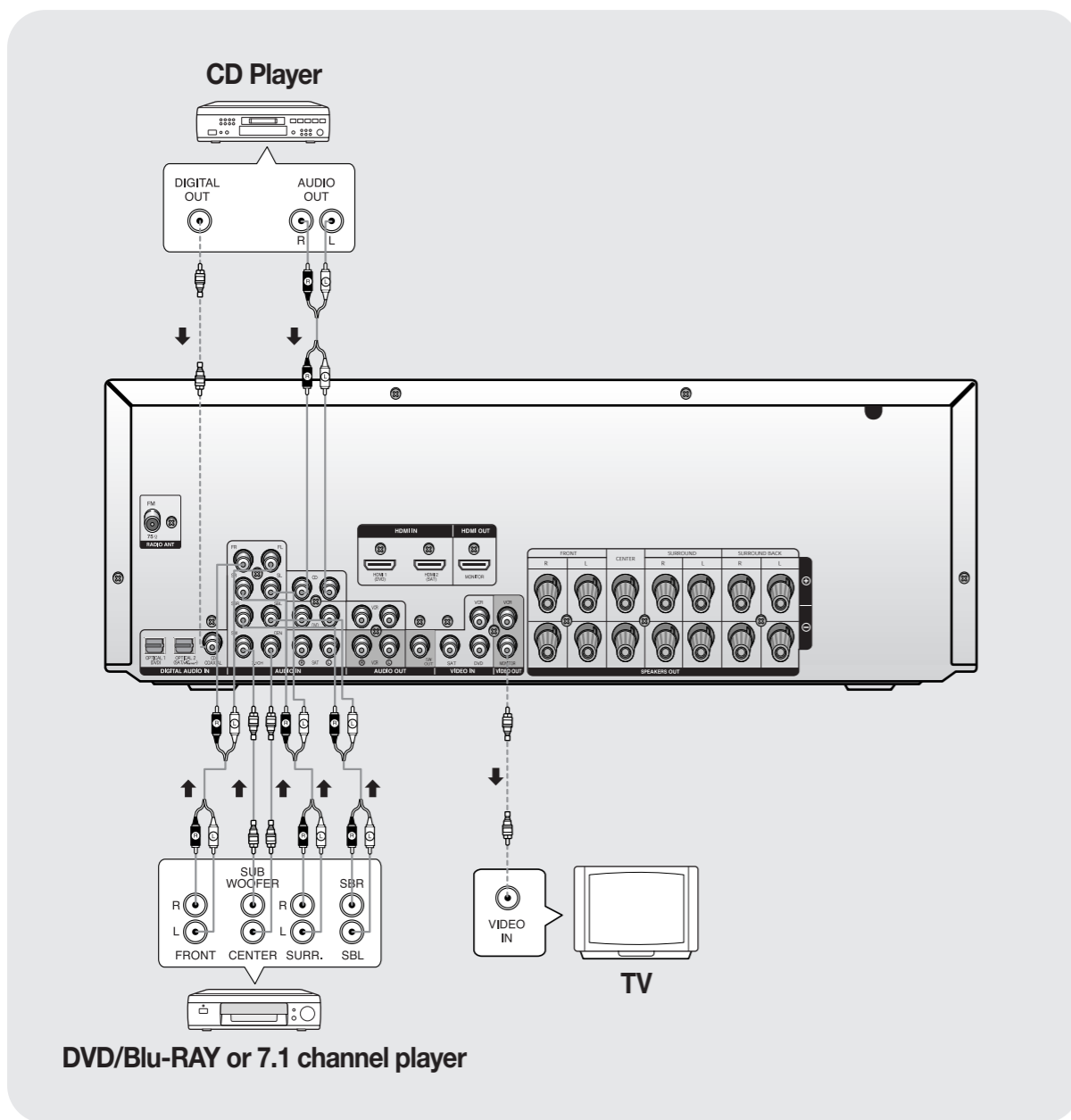

Connecting external devices via HDMI

By connecting through the HDMI(High-Definition Multimedia Interface) interface, you can play back digital video and audio without conversion to analog.

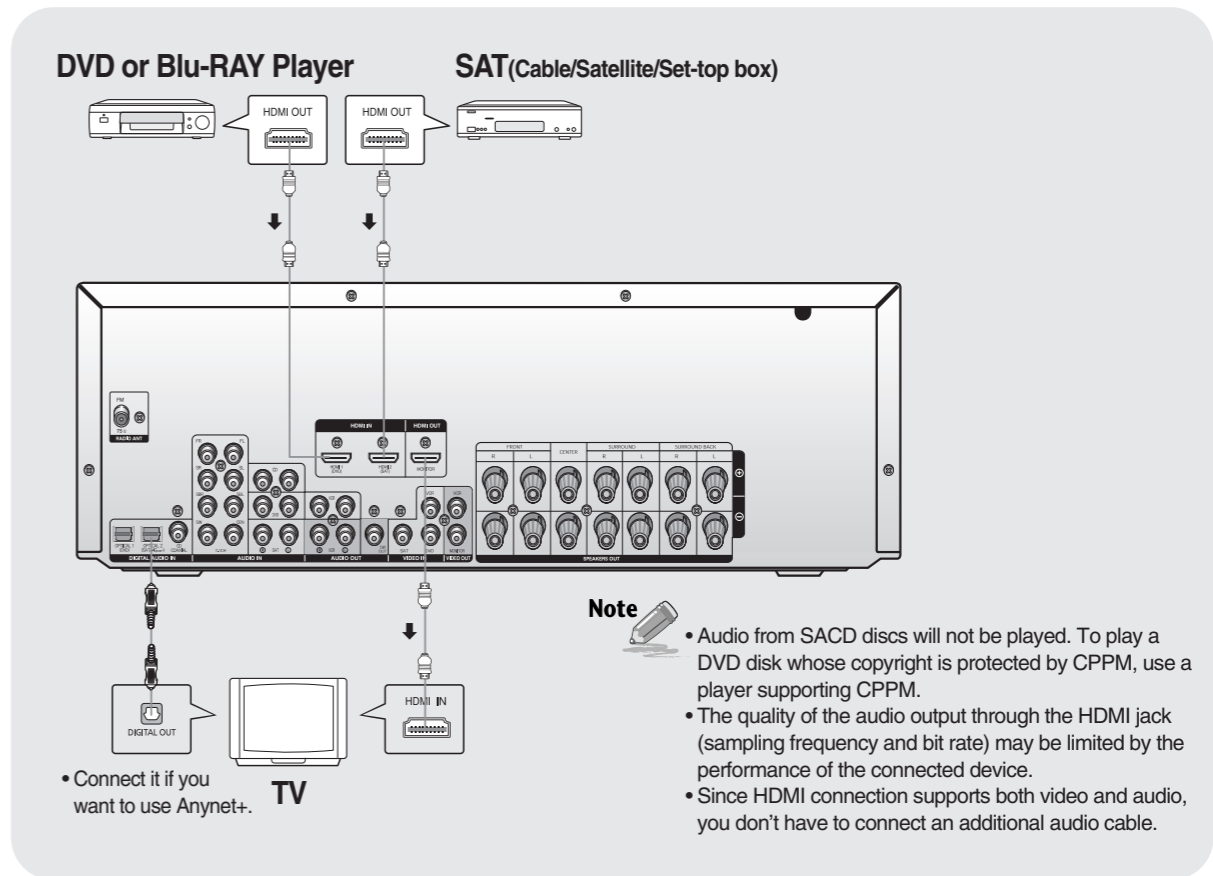

High-bandwidth Digital Content Protection System (HDCP) support

To play digital contents through the HDMI connection, both of the connected external device and TV must support High-bandwidth Digital Content Protection System (HDCP). This product supports HDCP.

COMPATIBILITY WITH A TV SUPPORTING HDMI	
A TV with an HDMI jack.	Video/Audio
A TV with a DVI-D jack (TV supporting HDCP)	Video
A TV with a DVI-D jack (TV not supporting HDCP)	-

Note • If you use an HDMI cable to connect a Samsung TV to the DVD Player, you can operate the AV receiver using the TV's remote control. This function is available only in connection with Samsung TV and DVD player supporting Anynet+ (HDMI-CEC).
• Please check the Anynet+ logo. If your TV has an Anynet+ logo, then it supports the Anynet+ function.

Using Anynet+(HDMI-CEC)

- 1 Connect the AV receiver to a Samsung TV with an HDMI cable. (See page 15)
- 2 Set the Anynet+ function on your TV. (See the TV instruction manual for more information.)
 - You can operate the AV receiver by using the TV remote control. (Available TV button : VOLUME \oplus , \ominus button.)



If you select TV

Set the Anynet+(HDMI-CEC) function to <On> on your TV.

- **Receiver : On** : You can listen to audio through the AV Receiver.
- **Receiver : Off** : You can listen to audio through the TV.

If you select the DVD Player

Select **THEATER** to connector and set the option of each items below.

- **View TV** : If Anynet+(HDMI-CEC) set to on and you select View TV, the AV receiver will automatically switch to SAT OPTIC2(DIGITAL IN).
- **Receiver : On** : You can listen to audio through the AV receiver.
- **Receiver : Off** : You can listen to audio through the TV.

To turn off Anynet+

- 1 Press **SETUP/MENU** button, and then press the **ENTER** button.
 - "SETUP MODE" appears on the display and goes into Setup Mode.
- 2 Press \blacktriangleleft \blacktriangleright button to select the "ANYNET+ MODE", and then press the **ENTER** button.
- 3 Press the \blacktriangleup \blacktriangledown button to set ANYNET+ to OFF.
 - If you are using Anynet+, set ANYNET+ to ON and if not, set it to OFF.

To exit setup mode

- Wait for about 5 seconds or press **SETUP** button. "SETUP OFF" appears on the display and Setup Mode is exited.



- When selecting View TV, you must have a digital optical cable connected from the TV to the AV receiver to listen to the TV sound through the AV receiver.

Caution

- When you are making Anynet+ connection, do not connect more than two AV receivers (Anynet+ installed). Otherwise, it can cause a malfunction.

With Anynet+

You can operate this unit, power on your TV, or watch a movie by pressing the Play button on your Samsung TV's remote control.

Connecting AUX components

You can connect external devices you use (camcorder, game console, mobile equipment, etc.) to the front of this unit for convenience.

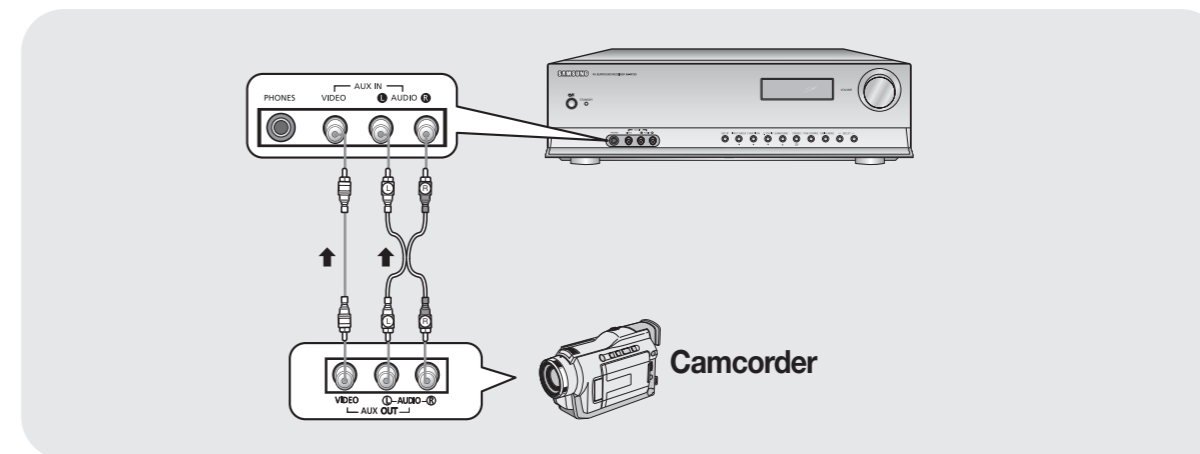

Connecting the FM antenna

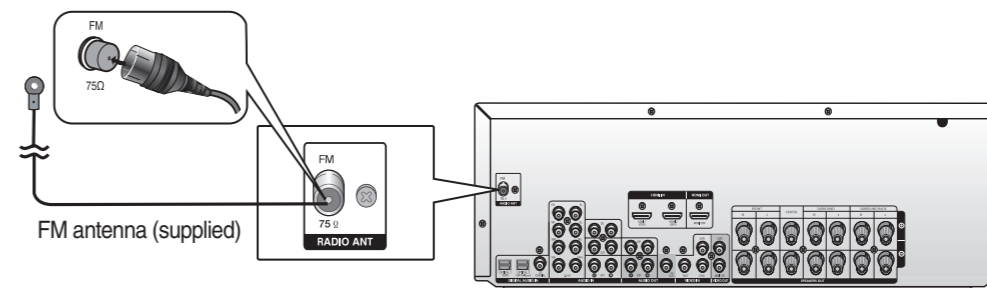

FM antenna connection

1. Connect the FM antenna supplied to the FM 75Ω COAXIAL terminal as a temporary measure.
2. Slowly move the antenna wire around until you find a location where reception is good, then fasten it to a wall or other rigid surface.



Before using the AV receiver



Selecting digital/analog Input

You can listen to sound in 2 channel analog , Dolby Digital or DTS using this unit.



Turning On/Off

Connect the power plug to the outlet.
 Press the **POWER** button of the remote control.

- This unit will be turned on or set to Standby mode.

Remote control functions

You can operate your AMP (this AV receiver), TV, DVD and VCR with this remote control.
 See pages 41-44 for more details.

To select a function

Method 1

Press the **FUNCTION** button.

- Each time you press this button, **FM** → **7. 1 MULTI CH** → **CD** → **DVD** → **SAT** → **VCR** → **AUX** will be selected in turn.

Method 2

Press **CD**, **VCR**, **DVD**, **7.1CH**, **SAT**, **AUX** or **TUNER** button.

- You can directly select the desired function.

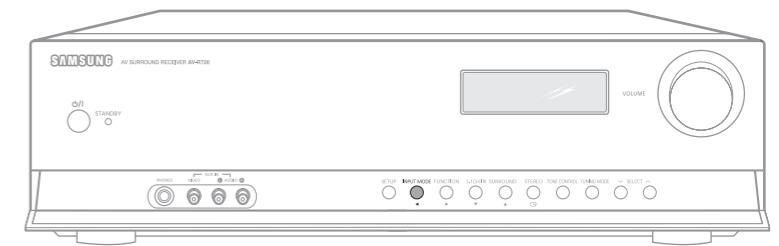

REMOTE CONTROL

Press the **INPUT MODE** button.

- Each time you press this button, input mode changes as follows:

MAIN UNIT

Press the **INPUT MODE** button.

- Each time the button is pressed, input mode changes as follows:

For DVD/SAT function

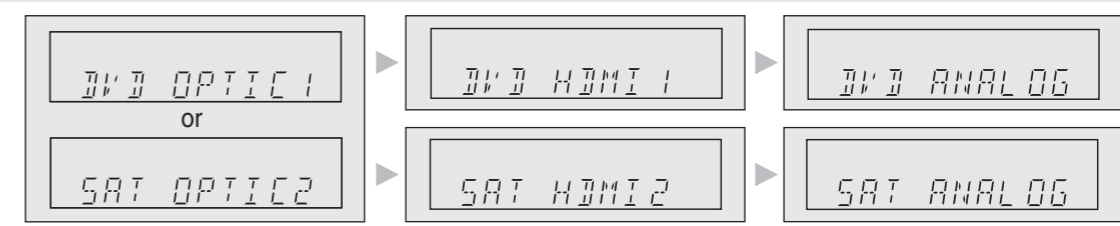

For CD function



- You can change the digital input setting for DVD, SAT and CD functions in the "DIGITAL IN" setup. (See page 23)
- You can enjoy Dolby Digital or DTS if you connect the digital audio output jack of an external audio component to the optical or coaxial digital audio input jack on the main unit.



Setting the speaker mode

Signal outputs and frequency response from the speaker will be adjusted according to your speaker configuration and whether certain speakers are used or not.



REMOTE CONTROL

- 1 Press **SETUP/MENU** button, and then press the **ENTER** button.
 - "SETUP MODE" appears on the display and goes into Setup Mode.
- 2 Press **◀▶** button to select the "SPK SETUP", and then press the **ENTER** button.
- 3 Press **◀▶** button to select the speaker you want.
 - Each time you press this button, FRONT → CEN → SURR → S.BACK → SUB → CROVR will be selected in turn.
- 4 Press **▲▼** button to set the mode (LARGE, SMALL etc.) for the selected speaker.
- 5 Repeat steps 3-4 to set the mode for each speaker.

To exit setup mode

- Wait for about 5 seconds or press **SETUP/MENU** button. "SETUP OFF" appears on the display and Setup Mode is exited.

Using the SPK SELECT button

- 1 Press **SPK SELECT** button to select the speaker you want.
 - Each time you press this button, FRONT → CEN → SURR → S.BACK → SUB → CROVR will be selected in turn.
- 2 Press **▲▼** button to set the mode (LARGE, SMALL etc.) for the selected speaker.
- 3 Repeat steps 1-2 to set the mode for each speaker.

To turn the SUBWOOFER on or off.

- Press **SUBWOOFER** button on the remote.
- Each time you press this button, SUB : YES, SUB : NO will be selected in turn.

Note

- If FRONT is set to LARGE, you can select YES or NO for SUB.
- If FRONT is set to SMALL, SUB is automatically set to YES. NO cannot be selected.

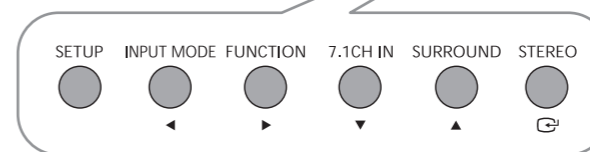
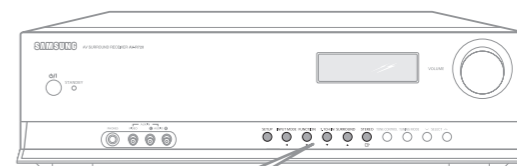

MAIN UNIT

- 1 Press **SETUP** button, and then press the **ENTER** (**↵**) button.
 - "SETUP MODE" appears on the display and goes into Setup Mode.
- 2 Press **◀▶** button to select the "SPK SETUP", and then press the **ENTER** (**↵**) button.
- 3 Press **◀▶** button to select the speaker you want.
 - Each time you press this button, FRONT → CEN → SURR → S.BACK → SUB → CROVR will be selected in turn.
- 4 Press **▲▼** button to set the mode (LARGE, SMALL etc.) for the selected speaker.
- 5 Repeat steps 3-4 to set the mode for each speaker.

To exit setup mode

- Wait for about 5 seconds or press **SETUP** button. "SETUP OFF" appears on the display and Setup Mode is exited.

Setting the Speaker

SPEAKER	Possible Settings	Default Setting
FRONT(Front)	LARGE,SMALL	SMALL
CEN(Center)	LARGE,SMALL,NONE	SMALL
SURR(Surround)	LARGE,SMALL,NONE	SMALL
S.BACK(Surround Back)	LARGE,SMALL,NONE	SMALL
SUB(Subwoofer)	YES,NO	YES
CROVR(Crossover Frequency)	60,80,100,120,150,180,200(Hz)	150Hz

- **LARGE** : Select when using large speakers. You can listen to full range sound.
- **SMALL** : Select this when using small speakers
- **NONE** : Select when no speaker is used
- **YES (subwoofer)** : Select when using the subwoofer speaker.
- **NO (subwoofer)** : Select when not using the subwoofer speaker.
- **CROVR** : Select the crossover frequency for the best bass response in your room.



Setting the speaker listening distance

If the speakers cannot be placed at equal distances from the listening position, you can adjust the delay time of the audio signals from the center and surround speakers.



Setting digital input

You can set the digital input for a DVD/SAT/CD player to either OPTICAL or COAXIAL to match the connections you've made .



- 1 Press **SETUP/MENU** button, and then press the **ENTER** button.
• "SETUP MODE" appears on the display and goes into Setup Mode.
- 2 Press **◀▶** button to select the "DIST SETUP", and then press the **ENTER** button.
- 3 Press **◀▶** button to select the speaker you want.
• Each time you press this button, F.L → CEN → F.R → S.R → SBR → SBL → S.L → S.W will be selected in turn.
- 4 Press **▲▼** button to set the speaker distance.
• For F.L, CEN, F.R, S.W, S.R, SBR, SBL, S.L Speaker, you can set the distance from the speaker to listening position between 0.3-9.0m in intervals of 0.3m.

To exit setup mode

- Wait for about 5 seconds or press **SETUP/MENU** button.
"SETUP OFF" appears on the display and Setup Mode is exited.

Setting Speaker Distance

Set the distance from the speaker to listening position in intervals of 0.3m.

- **F.L (front left)** : 0.9ft ~ 29.5ft
- **F.R (front right)** : 0.9ft ~ 29.5ft
- **SBR (surround back right)** : 0.9ft ~ 29.5ft
- **SBL (surround back left)** : 0.9ft ~ 29.5ft
- **S.L (surround left)** : 0.9ft ~ 29.5ft
- **CEN (center)** : 0.9ft ~ 29.5ft
- **S.R (surround right)** : 0.9ft ~ 29.5ft
- **SW (subwoofer)** : 0.9ft ~ 29.5ft



- If the listening position is beyond the range of the speaker distance setup, set the speaker distance to the maximum.
- The distance range of the overall speaker system is determined based on the F.L(front left) speaker distance from the listening position.
- Based on the max delay channel, the distance of the front speaker is 4.9ft(5ms) and the surround speaker can be set up to 14.7ft(15ms).

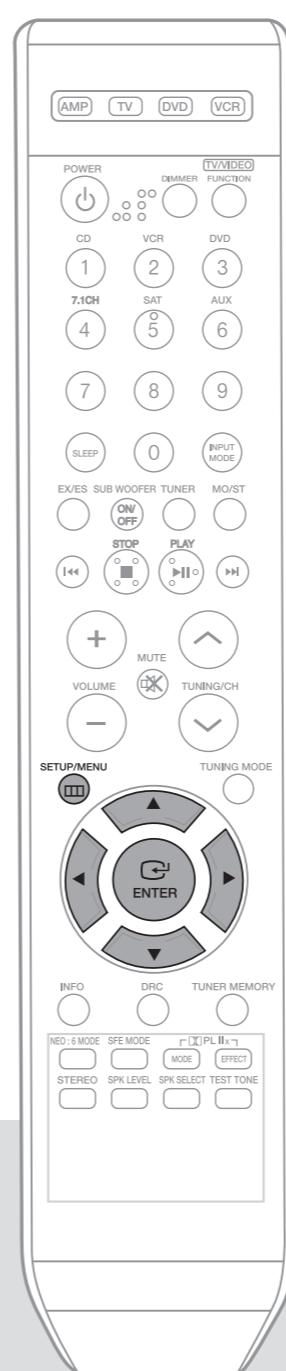

- 1 Press **SETUP/MENU** button, and then press the **ENTER** button.
• "SETUP MODE" appears on the display and goes into Setup Mode.
- 2 Press **◀▶** button to select the "DIGITAL IN", and then press **ENTER** button.
- 3 Press **◀▶** button to select the the CD, DVD or SAT function.
• Each time you press this button, CD → DVD → SAT will be selected in turn.
- 4 Press **▲▼** button to set the digital input.
• Each time you press this button, COAXIAL → OPTICAL2 → OPTICAL1 will be selected in turn.

To exit setup mode

- Wait for about 5 seconds or press **SETUP/MENU** button.
"SETUP OFF" appears on the display and Setup Mode is exited.



- You can select only one digital input for each function.
Example) If you have selected COAXIAL for the CD function, you cannot select COAXIAL for the DVD or SAT function.

Function	Digital input
DVD	OPTICAL1
SAT	OPTICAL2
CD	COAXIAL

Setting HDMI AUDIO

You can set HDMI audio settings.

Setting DRC (Dynamic Range Compression)

You can use this function to enjoy Dolby Digital sound when watching movies at low volume at night. DRC compresses the audio to make the loudest sounds quieter and the quietest sounds louder.



Before using!

- Press the INPUT MODE button to select HDMI1 or HDMI2. (see page 21)
- If you select Digital (Optical, Coaxial) or Analog, the HDMI audio setting will be deactivated.

- 1 Press **SETUP/MENU** button, and then press the **ENTER** button.
 - "SETUP MODE" appears on the display and goes into Setup Mode.
- 2 Press **◀▶** button to select the "HDMI AUDIO", and then press the **ENTER** button.
 - "HDMI : AVR" appears on the display.
- 3 Press **▲▼** button to set the HDMI audio.
 - Each time you press this button, HDMI : AVR → HDMI : TV will be selected in turn.

To exit setup mode

- Wait for about 5 seconds or press **SETUP/MENU** button. "SETUP OFF" appears on the display and Setup Mode is exited.

Setting HDMI AUDIO

- **AVR** : Audio is played on this product.
- **TV** : Audio is played on a TV connected to the HDMI OUT jack and no audio is played on this product.



- HDMI AUDIO setting is available only when the HDMI output is connected to a TV.
- If you do not hear sound from the TV, should change the HDMI audio output setting for your DVD PLAYER or SAT to PCM.

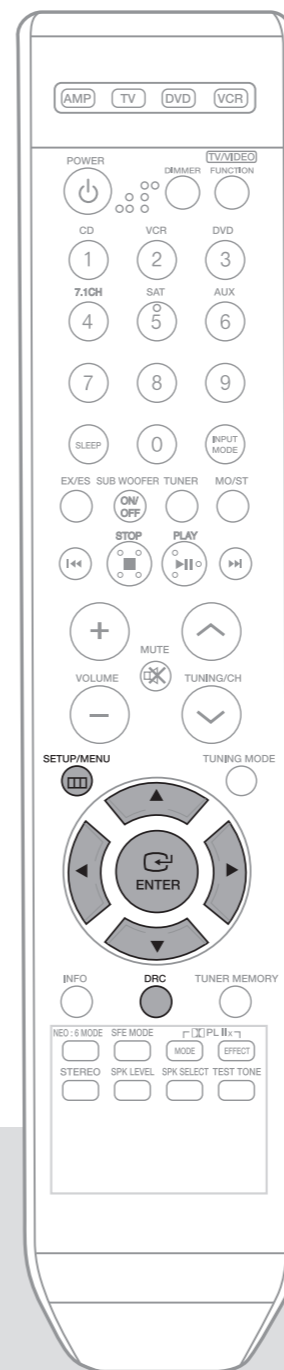

- 1 Press **SETUP/MENU** button, and then press the **ENTER** button.
 - "SETUP MODE" appears on the display and goes into Setup Mode.
- 2 Press **◀▶** button to select the "DRC SETUP", and then press the **ENTER** button.
 - "DRC:STD" appears on the display.
- 3 Press **▲▼** button to set the DRC.
 - Each time you press this button, DRC : STD → DRC : MAX → DRC : MIN will be selected in turn.

To exit setup mode

- Wait for about 5 seconds or press **SETUP/MENU** button. "SETUP OFF" appears on the display and Setup Mode is exited.

Using the DRC button

Press **DRC** button.

- Each time you press this button, DRC : STD → DRC : MAX → DRC : MIN will be selected in turn.

Setting DRC

- **STD** : Sets DRC effect to standard.
- **MAX** : Sets DRC effect to maximum.
- **MIN** : Sets DRC effect to minimum.

Test tone

Use the test tone check the speaker connection status or level.



To automatically output test tone



- 1 Press **SETUP/MENU** button, and then press the **ENTER** button.
 - "SETUP MODE" appears on the display and the unit goes into Setup Mode.
- 2 Press **◀▶** button to select the "TEST-T AUTO", and then press the **ENTER** button.
 - Test signal will be automatically output as follows; F.L → CEN → F.R → S.R → SBR → SBL → S.L → S.W .
 - During test signal output, press **▲▼** button to adjust the individual speaker output level from -10 to +10 dB by 1 step.

To stop test tone

- Press **SETUP/MENU** button once time. "SETUP OFF" appears on the display and test tone stops.

Using the Test Tone button

Press **TEST TONE** button.

- Test signal will be automatically output as follows; F.L → CEN → F.R → S.R → SBR → SBL → S.L → S.W.
- During test tone output, press **▲▼** button to adjust the speaker output level from -10 to +10 dB by 1 step.

To Manually Output Test Tone



- 1 Press **SETUP/MENU** button, and then press the **ENTER** button.
 - "SETUP MODE" appears on the display and goes into Setup Mode.
- 2 Press **◀▶** button to select the "TEST-T MANU", and then press the **ENTER** button.
- 3 Press **◀▶** button to select the speaker you want.
 - Each time you press **◀▶** button, F.L → CEN → F.R → S.R → SBR → SBL → S.L → S.W will be selected in turn.
- 4 Press **▲▼** button to set the test tone as you want.
 - You can adjust the speaker output level from -10 to +10dB by 1 step.
 - The sound gets quieter at -10dB and louder at +10dB.

To stop test tone

- Press **SETUP/MENU** button once time. "SETUP OFF" appears on the display and test tone stops.

Test Tone Output

- **F.L (front left)** : -10 ~ +10dB
- **CEN (center)** : -10 ~ +10dB
- **F.R (front right)** : -10 ~ +10dB
- **S.R (surround right)** : -10 ~ +10dB
- **SBR (surround back right)** : -10 ~ +10dB
- **SBL (surround back left)** : -10 ~ +10dB
- **S.L (surround left)** : -10 ~ +10dB
- **S.W (subwoofer)** : -10 ~ +10dB



Setting speaker level

You can set the balance and level of speakers.



Dolby Pro Logic IIx mode

This mode provides 7.1 channel sound from 2 channel sources.



- 1 Press **SETUP/MENU** button, and then press the **ENTER** button.
 - "SETUP MODE" appears on the display and goes into Setup Mode.
- 2 Press **◀▶** button to select the "LEVEL SETUP", and then press the **ENTER** button.
- 3 Press **◀▶** button to select the speaker you want.
 - Each time you press **◀▶** button, F.L → CEN → F.R → S.R → SBR → SBL → S.L → S.W will be selected in turn.
- 4 Press **▲▼** button to set the speaker mode.
 - You can adjust it from -10 to +10dB by 1 step.
 - The sound gets quieter at -10dB and louder at +10dB.

To exit setup mode

- Wait for about 5 seconds or press **SETUP/MENU** button. "SETUP OFF" appears on the display and Setup Mode is exited.

Using the SPK LEVEL button

- 1 Press **SPK LEVEL** button to select the speaker you want.
 - Each time you press this button, F.L → CEN → F.R → S.R → SBR → SBL → S.L → S.W → SPK LVL OFF will be selected in turn.
- 2 Press **▲▼** button to set the speaker level you want.
 - You can adjust it from -10 to +10dB by 1 step.
 - The sound gets quieter at -10dB and louder at +10dB.

Setting Speaker Level

- **F.L (front left)** : -10 ~ +10dB
- **CEN (center)** : -10 ~ +10dB
- **F.R (front right)** : -10 ~ +10dB
- **S.R (surround right)** : -10 ~ +10dB
- **SBR (surround back right)** : -10 ~ +10dB
- **SBL (surround back left)** : -10 ~ +10dB
- **S.L (surround left)** : -10 ~ +10dB
- **S.W (subwoofer)** : -10 ~ +10dB

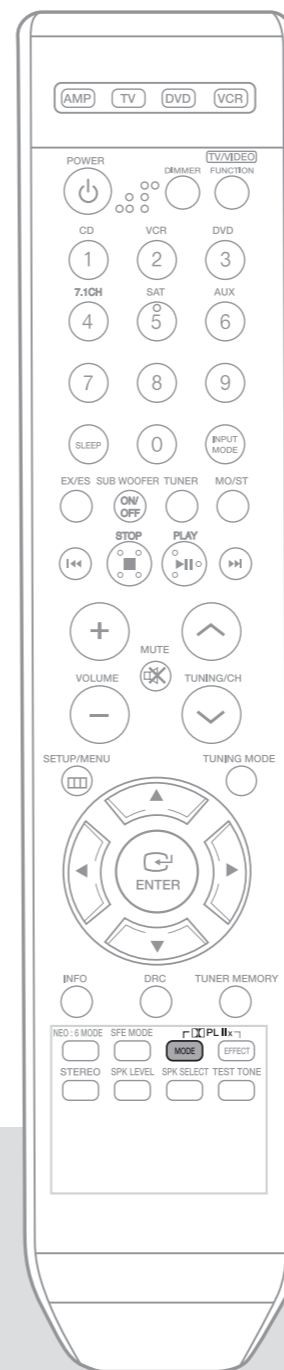

REMOTE CONTROL

Press **PLIIx MODE** button.

- Each time you press this button, CINEMA → MATRIX → GAME → PL → MUSIC will be selected in turn.



MAIN UNIT

- 1 Press **SURROUND** button to select "DPLIIx" mode.
 - Each time you press this button, DPLIIx → NEO:6 → SFE → STEREO will be selected in turn.
- 2 Press **SELECT (▼, ▲)** button.
 - Each time you press **SELECT (▲)** button, CINEMA → MATRIX → GAME → PL → MUSIC will be selected in turn.
 - Each time you press **SELECT (▼)** button, MUSIC → PL → GAME → MATRIX → CINEMA will be selected in turn.

To exit setup mode

- Wait for about 5 seconds.

Dolby Pro Logic IIx mode

- **MUSIC** : Provides 7.1 channel surround sound for digital, analog or existing stereo sources such as CD, TAPE, FM, TV and stereo VCR.
- **CINEMA** : Adds realism to the movie soundtrack.
- **MATRIX** : You will hear 7.1 channel surround sound.
- **GAME** : Enhances the excitement of the game's sound.
- **PL** : You will experience a surround effect with just the front left and right speakers.

Note

- You cannot use Dolby Pro Logic IIx mode for multi channel signals such as Dolby Digital and DTS.
- Pro Logic works only for PCM audio signals with sampling frequencies of 32KHz, 44KHz or 48KHz.
- Sound will not be output from the surround back speaker if the PCM audio signal is mono.



Setting Dolby Pro Logic IIx effect

This function works only in Dolby PRO LOGIC IIx MUSIC Mode.



Setting NEO:6 mode

You can play back 2 channel sound over 6.1 channels when enjoying music or a movie.



1 Press **SETUP/MENU** button, and then press the **ENTER** button.
 • "SETUP MODE" appears on the display and goes into Setup Mode.

2 Press **◀▶** button to select the "DOLBY PL IIx MODE", and then press the **ENTER** button.

3 Press **◀▶** button.
 • Each time you press this button, C-WIDTH → DIMENSION → PANORAMA will be selected in turn.

4 Press **▲▼** button to set the Dolby Pro Logic IIx effect you want.

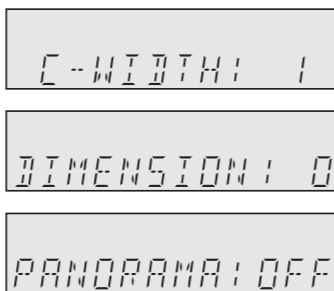

To exit setup mode

• Wait for about 5 seconds or press **SETUP/MENU** button.
 "SETUP OFF" appears on the display and Setup Mode is exited.

Using the DOLBY PL IIx EFFECT button

- Press **DOLBY PL IIx MODE** button to select 'MUSIC' Mode.
- Press **DOLBY PL IIx EFFECT** button.
 • Each time you press this button, C-WIDTH → DIMENSION → PANORAMA will be selected in turn.
- Press **▲▼** button to select Dolby Pro Logic IIx effect you want.
 • C-WIDTH : You can set from 0 to 7.
 • DIMENSION : You can set from -7 to +7.
 • PANORAMA : You can set it ON or OFF.

Dolby Pro Logic IIx effect

- **C-WIDTH** : This sets the width of the center image. The higher the setting, the less sound comes from the center speaker.
- **DIMENSION** : Incrementally adjusts the sound field (DSP) from the front or surround.
- **PANORAMA** : This mode extends the front stereo image to include the surround speakers for an exciting "wraparound" effect with side wall imaging.

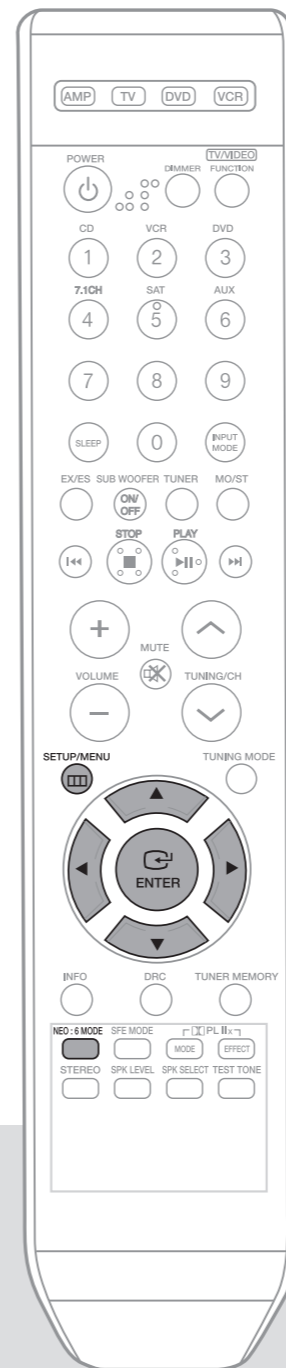

REMOTE CONTROL

Press **NEO:6 MODE** button.

• Each time you press this button, MUSIC → CINEMA will be selected in turn.

MAIN UNIT

- Press **SURROUND** button briefly to select "NEO:6" mode.
 • Each time you press this button, DPLIIx → NEO:6 → SFE → STEREO will be selected in turn.
- Press **SELECT** (**▼, ▲**) button.
 • Each time you press this button, MUSIC → CINEMA will be selected in turn.

To set the height of the center sound image

If your TV (or screen) is installed high on a wall, you can raise the center sound image of the front and center speakers to compensate.

- Press **SETUP/MENU** button, and then press the **ENTER** button.
 • "SETUP MODE" appears on the display and goes into Setup Mode.
- Press **◀▶** button to select the "NEO:6 MODE", and then press the **ENTER** button.
 • "CEN -- IMG : 2" appears on the display.



- Press **▲▼** button to set the sound image you want.
 • You can set the sound image from 0 to 5.
 • This parameter adjusts the height of the center image through the front and center speakers. "0" is the lowest while "5" is the highest.

To exit setup mode

• Wait for about 5 seconds or press **SETUP/MENU** button.
 "SETUP OFF" appears on the display and Setup Mode is exited.

NEO : 6 Mode

This mode decodes 2 channel signals to a high precision digital matrix decoder. for 6.1 channel sound.

- **MUSIC** : NEO:6 MUSIC mode is optimized for music playback
- **CINEMA** : NEO:6 CINEMA mode is optimized for movie playback.

Note

- NEO:6 mode cannot be used with DTS and Dolby Digital multi channel signals.
- Pro Logic works only for PCM audio signals with sampling frequencies of 32KHz, 44KHz or 48KHz.



Setting EX/ES mode

When surround back speakers are connected, you can listen to 6.1 or 7.1 multi-channel sound using the built-in Dolby Digital Surround EX or DTS ES decoder. This function works when a Dolby Digital or DTS source (such as a DVD player) is input, and does not work with L.PCM and Dolby Digital 2 channel sources.



- 1 Press **SETUP/MENU** button, and then press the **ENTER** button.
 - "SETUP MODE" appears on the display and goes into Setup Mode.
- 2 Press **◀▶** button to select the "EX/ES SETUP", and then press the **ENTER** button.
 - "EX/ES : AUTO" appears on the display.
- 3 Press **▲▼** button to set the EX/ES you want.
 - Each time you press this button, EX/ES : AUTO → EX/ES : ON → EX/ES : OFF will be selected in turn.

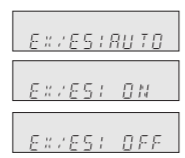

To exit setup mode

- Wait for about 5 seconds or press **SETUP/MENU** button. "SETUP OFF" appears on the display and Setup Mode is exited.

Using the EX/ES button

Press **EX/ES** button.

- Each time you press this button, EX/ES : AUTO → EX/ES : ON → EX/ES : OFF will be selected in turn.
- The EX/ES button on the remote control is enabled only if the input source is of Dolby Digital or DTS.

EX/ES Mode

- **AUTO** : If the unit receives an audio signal that it can recognize, it will select an optimal decoder for playback in 6.1/7.1 channel. If the amplifier does not recognize the audio signal, it will not play in 6.1/7.1 channel automatically.
- **ON** : Dolby Digital or DTS signal will be played in 6.1 / 7.1 channel using Dolby Digital Surround EX / DTS ES decoder.
- **OFF** : Dolby Digital Surround EX / DTS ES decoder will not be used for playback.

Dolby Digital - EX

Movie soundtracks encoded with Dolby Digital EX will play audio over the surround back channels also.

Note

- You cannot use Dolby Digital-EX in the system without Surround Back speakers connected.
- EX/ES Mode must be set to On when playing back discs encoded with 6.1 channel Dolby Digital-EX.
- Some discs encoded with Dolby Digital-EX do not contain an identification signal. In this case, set EX/ES to ON.

DTS-ES (Discrete 6.1, Matrix 6.1)

A surround back channel is added to the DTS 5.1 channel system, improving the sense of sound directionality and space. A built-in DTS-ES decoder has been equipped with this system that supports discs encoded with DTS-ES Direct and DTS-ES Matrix.

Note

- You cannot use DTS-ES without surround back speakers connected.



Setting Tone Control

This function allows setting up the tone quality of the front speakers.

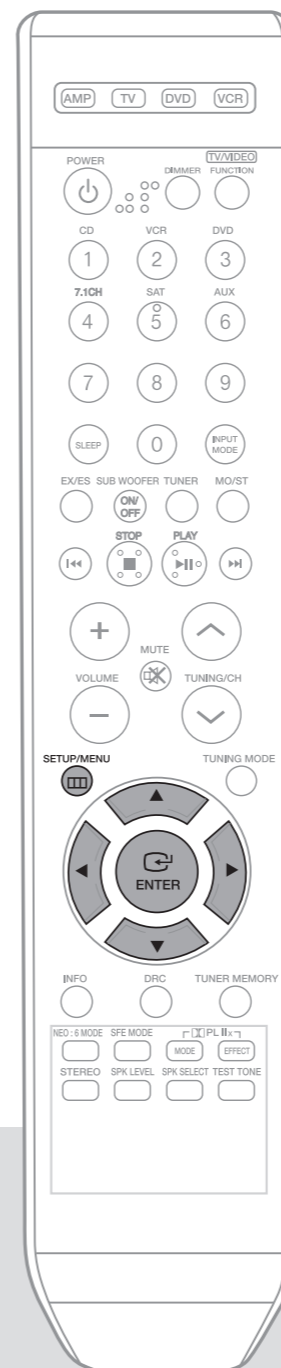

- 1 Press **SETUP/MENU** button, and then press the **ENTER** button.
 - "SETUP MODE" appears on the display and goes into Setup Mode.
- 2 Press **◀▶** button to select "TONE CONTROL", and then press the **ENTER** button.
- 3 Press **◀▶** button.
 - Each time you press this button, BASS → TREBLE → TONE : OFF will be selected in turn.
 - If it is set to TONE : OFF, the Tone Control function will be disabled.
- 4 Press **▲▼** button to set the tone control you want.
 - You can adjust it from -6 to +6dB by 1 step.
 - The sound gets smaller at -6dB and louder at +6dB.

To exit setup mode

- Wait for about 5 seconds or press **SETUP/MENU** button. "SETUP OFF" appears on the display and Setup Mode is exited.

Note

- Tone Control function is available only in the Stereo mode.

SFE mode

The SFE (Sound Field Effect) function uses 7 different DSP sound field effects to digitally simulate actual music environments such as concert halls or cinemas.

Stereo mode

You can select this mode when listening to sound through the front left and right speakers and subwoofer.



REMOTE CONTROL

Press **SFE MODE** button.

- Each time you press this button, HALL → THEATER → ARENA → CLUB → DOME → STADIUM → CHURCH will be selected in turn.



MAIN UNIT

1 Press **SURROUND** button to select 'SFE' Mode.

- Each time you press this button, DPLIIX → NEO:6 → SFE → STEREO will be selected in turn.

2 Press **SELECT** (,) button.

- Each time you press Select (,) button, HALL ↔ THEATER ↔ ARENA ↔ CLUB ↔ DOME ↔ STADIUM ↔ CHURCH will be selected in turn.

To exit setup mode

- Wait for about 5 seconds.

REMOTE CONTROL

Press **STEREO** button.

- "STEREO" appears in the display and Stereo Mode is selected.

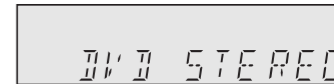

MAIN UNIT

Press **SURROUND** button to select 'STEREO'.

- Each time you press this button, DPLIIX → NEO:6 → SFE → STEREO will be selected in turn.
- If you press the STEREO button on the player, it will switch to STEREO mode.

To exit setup mode

- Wait for about 5 seconds.

Surround Mode and Input Signal Chart

o = active, - = inactive

Surround Mode	Input Signal	Decoding	Output Channel					Display Information			
			L/R	C	SL/SR	SBL/SBR	SubW	Display Signal Format	Channel Status		
DOLBY (MUSIC, CINEMA, MATRIX, GAME, PRO LOGIC)	Dolby D Surr. EX	Dolby Digital 5.1	o	o	o	o	o	o	o	DIGITAL	L, C, R, SL, SR, SBL, SBR, SW
	Dolby D (5.1ch)	Dolby Digital 5.1	o	o	o	-	o	o	o	DIGITAL	L, C, R, SL, SR, SW
	Dolby D (2ch)	Pro Logic II x	o	o	o	o	o	o	o	DIGITAL	L, C, R, SL, SR, SBL, SBR, SW
	Dolby D (2ch Surr)	Pro Logic II x	o	o	o	o	o	o	o	DIGITAL	L, C, R, SL, SR, SBL, SBR, SW
	L.PCM (Audio)	Pro Logic II x	o	o	o	o	o	o	o	L.PCM	L, C, R, SL, SR, SBL, SBR, SW
	Analog	Pro Logic II x	o	o	o	o	o	o	o	ANALOG	L, C, R, SL, SR, SBL, SBR, SW
NEO:6 (MUSIC, CINEMA)	L.PCM (Audio)	Neo:6	o	o	o	o	o	o	o	L.PCM	L, C, R, SL, SR, SBL, SBR, SW
	Analog	Neo:6	o	o	o	o	o	o	o	ANALOG	L, C, R, SL, SR, SBL, SBR, SW
	Dolby D (2ch)	Neo:6	o	o	o	o	o	o	o	DIGITAL	L, C, R, SL, SR, SBL, SBR, SW
	Dolby D (2ch Surr)	Neo:6	o	o	o	o	o	o	o	DIGITAL	L, C, R, SL, SR, SBL, SBR, SW
SFE	Dolby D (2ch)	DD+SFE	o	o	o	-	o	o	o	DIGITAL	L, C, R, SL, SR, SW
	Dolby D (2ch Surr)	DD+SFE	o	o	o	-	o	o	o	DIGITAL	L, C, R, SL, SR, SW
	L.PCM (Audio)	SFE	o	o	o	-	o	o	o	L.PCM	L, C, R, SL, SR, SW
	Analog	SFE	o	o	o	-	o	o	o	ANALOG	L, C, R, SL, SR, SW
EX/ES	Dolby D Surr. EX	Dolby Digital EX	o	o	o	o	o	o	o	DIGITAL	L, C, R, SL, SR, SBL, SBR, SW
	Dolby D (5.1ch)	Dolby Digital EX	o	o	o	o	o	o	o	DIGITAL	L, C, R, SL, SR, SBL, SBR, SW
	DTS-ES	DTS-ES	o	o	o	o	o	o	o	dts, ES	L, C, R, SL, SR, SBL, SBR, SW
	DTS (5.1ch)	DTS-ES	o	o	o	o	o	o	o	dts	L, C, R, SL, SR, SBL, SBR, SW
STEREO	Dolby D (2ch)	Stereo	o	-	-	-	o	o	o	DIGITAL	L, R, SW
	Dolby D (2ch Surr)	Stereo	o	-	-	-	o	o	o	DIGITAL	L, R, SW
	L.PCM (Audio)	Stereo	o	-	-	-	o	o	o	L.PCM	L, R, SW
	L.PCM 96KHz	Stereo	o	-	-	-	o	o	o	L.PCM	L, R, SW
	Analog	Stereo	o	-	-	-	o	o	o	ANALOG	L, R, SW

L/R : front speaker (left/right) C : center speaker SL/SR : surround speaker (left/right) SBL/SBR : surround back speaker (left/right) SW : subwoofer



- Channel status displays are dependent on the speaker configuration.
- SFE mode works with 2-ch signals.



Listening to radio

You can listen to the chosen band (FM) by using either automatic or manual tuning.



Presetting radio Stations

You can preset up to 30 FM stations.

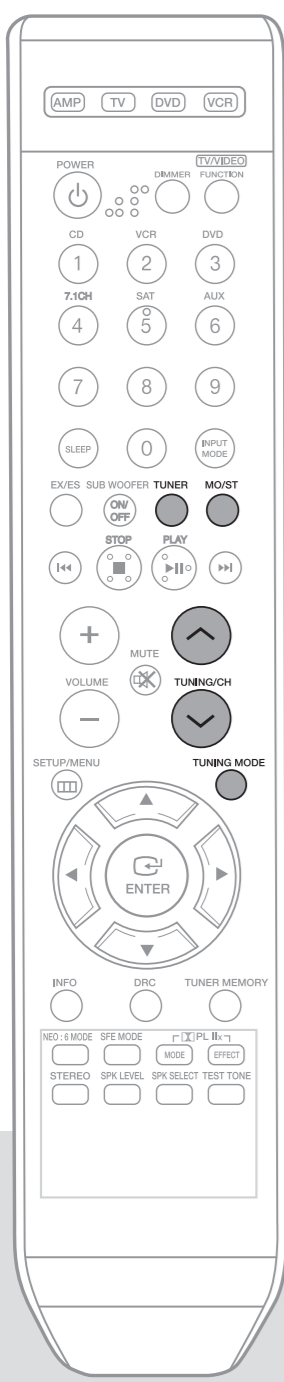

REMOTE CONTROL

- 1 Press **TUNER** button.
- 2 Selected frequency.
 - Automatic tuning 1 :
 - 1) Press **TUNING MODE** button to select PRESET.
 - 2) Press **TUNING/CH (▼,▲)** button to select the preset frequency.
 - Automatic tuning 2 :
 - 1) Press **TUNING MODE** button to select MANUAL
 - 2) Press and hold **TUNING/CH (▼,▲)** button to automatically tune in frequency.
 - Manual tuning :
 - 1) Press **TUNING MODE** button to select MANUAL.
 - 2) Press **TUNING/CH (▼,▲)** button briefly to increase or decrease the frequency step by step.

MAIN UNIT

- 1 Press **FUNCTION** button to select FM.
- 2 Select the frequency.
 - Automatic tuning 1 :
 - 1) Press **TUNING MODE** button to select PRESET.
 - 2) Press **TUNING/CH (▼,▲)** button to select the preset frequency.
 - Automatic tuning 2 :
 - 1) Press **TUNING MODE** button to select MANUAL
 - 2) Press and hold **TUNING/CH (▼,▲)** button to automatically tune in frequency.
 - Manual tuning :
 - 1) Press **TUNING MODE** button to select MANUAL.
 - 2) Press **TUNING/CH (▼,▲)** button briefly to increase or decrease the frequency step by step.

- To Listen to mono/stereo**
Press **MO/ST** button on the remote.
- Each time you press this button, STEREO → MONO will be selected in turn.
 - If you select MONO in an area with weak reception, it will help to reduce noise.
 - This function works only with the Remote Control.

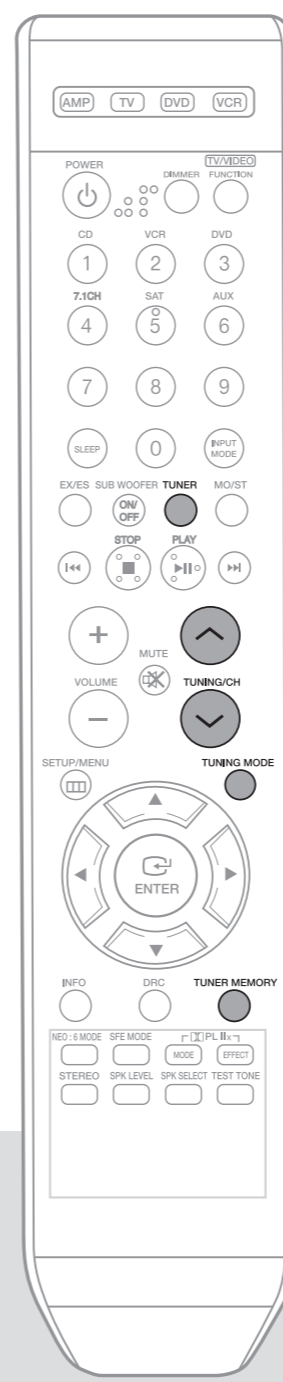

E.g.: Setting station FM 89.10 in preset 2 .

- 1 Press **TUNER** button.
- 2 Press **TUNING MODE** button to select MANUAL and then press **TUNING/CH(▼,▲)** button to select 89.10.
 - Refer to step 2, page 38, to tune in automatically and manually.
- 3 Press **TUNER MEMORY** button.
 - Tuner number will blink on the display.
- 4 Press **TUNING/CH(▼,▲)** button to select preset 2.
 - You can select from presets 1 to 30.
- 5 Press **TUNER MEMORY** button.
 - Tuner number will disappear and station 89.10 will be saved in preset 2.
- 6 To preset other stations, repeat steps 2 to 5.

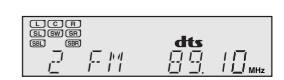
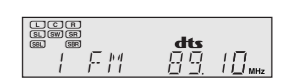
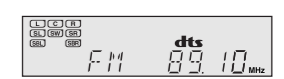

- To Listen to Preset Station**
- Press **TUNING MODE** button of the remote control to select the PRESET and press **TUNING/CH (▼,▲)** button.



Convenient functions



Sleep timer function

You can set the time that this unit will shut itself off.

Press the **SLEEP** button.

- SLEEP : OFF → 15 → 30 → 45 → 60 → 90 → 120 M (MIN) will be selected in turn.

To check sleep timer

Press the **SLEEP** button.

- The remaining time before this unit will shut itself off is shown on the display.
- Pressing the button again changes the sleep time from what you set previously.

To cancel sleep timer

- Press **SLEEP** button until "SLEEP : OFF" appears on the display.

Mute function

This function is useful when answering a doorbell or telephone call.

Press the **MUTE** button.

- **MUTE** appears on the display.

To output sound again

Press the **MUTE** button again.

- **MUTE** will disappear and sound will output.



• SLEEP, Mute and the Adjust Display functions can only be operated with the remote control.



Reset function

REMOTE CONTROL

- 1 Press the **MUTE** button.
 - **MUTE** appears on the display.
- 2 Press "0" button five times and then press the **ENTER** button.
 - "INITIAL : NO" appears on the display.
- 3 Press **▲▼** buttons to select "YES".
 - The unit will turn off after 5 seconds.

MAIN UNIT

- 1 Turn off the power and hold the **SELECT(▲)** button for longer than 5 seconds.
 - **POWER STANDBY** indicator will flash.

Caution!

- Using the **RESET** function will erase all stored settings.
- Do not use this unless necessary.



Convenient functions (cont'd)



Operating your TV with the remote control



Adjust the display

You can adjust the brightness of the display.
 Press the **DIMMER** button.
 • Each time you press this, the brightness changes as follows : DARK → BRIGHT.

Using headphones

Use headphones (not supplied) for private listening pleasure.
 Connect the headphones to the headphone jack and listen to music.

Note • Do not turn the volume up too high when you use headphones as it may damage your hearing.



1 Press **POWER** button to turn on the TV.

2 Press **TV** button to set the remote to TV mode.

3 Point the remote control toward the TV.

4 While holding down **POWER** button, enter the code corresponding to your brand of TV.
 • If there is more than one code listed for your TV in the table, enter one at a time to determine which code works.
 • If the code matches the TV's code, the TV will be turned off.

5 If TV is turned on or off when you press the power button of the remote control, the setting is completed.
 • You can use the TV POWER, VOLUME, CHANNEL, MENU and Numeric buttons (0~9).

Note
 • The remote control may not work on some brands of TVs. Also, some operations may not be possible depending on your brand of TV.
 • The remote control will work with Samsung TVs by default.

MISCELLANEOUS



Operating your TV with the remote control (cont'd)

TV Brand Code List

Brand	Code Number	Brand	Code Number	Brand	Code Number
ADMIRAL (M.WARDS)	056, 057, 058	LUXMAN	018	SYLVANIA	018, 040, 048, 054, 059, 060, 062
A MARK	001, 015	LXI (SEARS)	019, 054, 056, 059, 060, 062, 063, 065, 071	SYMPHONIC	061, 095, 096
ANAM	001, 002, 003, 004, 005, 006, 007, 008, 009, 010, 011, 012, 013, 014	MAGNAVOX	015, 017, 018, 048, 054, 059, 060, 062, 072, 089	TATUNG	006
AOC	001, 018, 040, 048	MARANTZ	040, 054	TECHWOOD	018
BELL & HOWELL (M.WARDS)	057, 058, 081	MATSUI	054	TEKNIKA	003, 015, 018, 025
BROCSOINIC	059, 060	MGA	018, 040	TMK	018, 040
CANDLE	018	MITSUBISHI/MGA	018, 040, 054, 059, 060, 075, 101	TOSHIBA	019, 057, 063, 071, 101, 107, 109, 110, 111, 113
CETRONIC	003	MTC	018	VIDTECH	018
CITIZEN	003, 018, 025	NEC	018, 019, 020, 040, 059, 060	VIDECH	059, 060, 069
CINEMA	097	NIKEI	003	WARDS	015, 017, 018, 040, 048, 054, 060, 064
CLASSIC	003	ONKING	003	YAMAHA	018
CONCERTO	018	ONWA	003	YORK	040
CONTEC	046	PANASONIC	006, 007, 008, 009, 054, 066, 067, 073, 074	YUPITERU	003
CORONADO	015	PENNEY	018	ZENITH	058, 079
CRAIG	003, 005, 061, 082, 083, 084	PHILCO	003, 015, 017, 018, 048, 054, 059, 062, 069, 090	ZONDA	001
CROSLER	062	PHILIPS	015, 017, 018, 040, 048, 054, 062, 072, 112, 114, 117, 118	DONGYANG	003, 054
CROWN	003	PIONEER	063, 066, 080, 091	LOWE	054
CURTISMATHES	059, 061, 063	PORTLAND	015, 018, 059	FINLUX	054, 109, 114
CXC	003	PROTON	040	YOKO	054
DAEWOO	002, 003, 004, 015, 016, 017, 018, 019, 020, 021, 022, 023, 024, 025, 026, 027, 028, 029, 030, 032, 034, 035, 036, 040, 048, 059, 090, 099, 100	QUASAR	006, 066, 067	LOEWE OPTA	054, 114
DAYTRON	040	RADIO SHACK	017, 048, 056, 060, 061, 075	PHONOLA	054, 112, 114
DYNASTY	003	RCA/PROSCAN	018, 059, 067, 076, 077, 078, 092, 093, 094	RADIOLA	054, 112
EMERSON	003, 015, 040, 046, 059, 061, 064, 082, 083, 084, 085	REALISTIC	003, 019	SCHNEIDER	054
FISHER	019, 065, 103	SAMPO	040	AKAI	103
FUNAI	003	SAMSUNG	000, 015, 016, 017, 040, 043, 046, 047, 048, 049, 054, 059, 060, 098	GRUNDIG	108, 109, 113, 119, 120, 121
FUTURETECH	003	SANYO	019, 061, 065, 101, 102, 103, 104	BLAUPUNKT	108
GENERAL ELECTRIC (GE)	006, 040, 056, 059, 066, 067, 068	SCOTT	003, 040, 060, 061	SIEMENS	108
HALL MARK	040	SEARS	015, 018, 019	CGE	113
HITACHI	015, 018, 050, 059, 069	SHARP	015, 057, 064, 101, 105, 106, 115	IMPERIAL	113
INKEL	045	SIGNATURE2000 (M.WARDS)	057, 058	MIVAR	113
JC PENNY	056, 059, 067, 086	SONY	050, 051, 052, 053, 055, 101	SABA	114
JVC	070	SOUNDESIGN	003, 040	BANG&OLUFSEN	114
KTV	059, 061, 087, 088	SPECTRICON	001	BRIONVEGA	114
KEC	003, 015, 040	SSS	018	FORMENTI	114
KMC	015			METZ	114
LG (GOLDSTAR)	001, 015, 016, 017, 037, 038, 039, 040, 041, 042, 043, 044, 054, 086			WEGA	114
				RADIOMARELLI	114
				SINGER	114
				SINUDYNE	114
				TELEFUNKEN	116



Operating your DVD or VCR with the remote control



- 1 Press **POWER** button to turn on the DVD (VCR).
- 2 Press **DVD** button to set the remote to DVD mode.
 - If you operate VCR, press VCR button to set the remote to VCR mode.
- 3 Point the remote control toward the DVD (VCR).
- 4 While holding down **POWER** button, enter the code corresponding to your brand of DVD (VCR).
 - If there is more than one code listed for your DVD (VCR) in the table, enter one at a time to determine which code works.
 - If the code matches the DVD (VCR)'s code, the DVD (VCR) will be turned off.
- 5 If DVD (VCR) is turned on or off when you press the power button of the remote controller, the setting is completed.
 - You can use DVD (VCR) POWER, VOLUME, PLAY, PAUSE, STOP, SKIP, MENU and Numeric button (0-9).



Note

- The remote control may not work on some brands of DVD (VCR). Also, some operations may not be possible depending on your brand of DVD (VCR).
- The remote control will work with Samsung DVD (VCR) by default.



Operating your DVD or VCR with the remote control (cont'd)

VCR Brand Code List

Brand	Code Number	Brand	Code Number	Brand	Code Number
ADMIRAL (M.WARDS)	043, 106	MEI	001,033	TASHIRO	050
AWIA	044, 045, 046	MEMOREX	001,025,033,054,091,100	TATUNG	047,052,092
AKAI	088,089,090	MINOLTA	020,021,062	TEAC	044,047,052,092
ANAM	001,002,003,004,005,033	MITSUBISHIMGA	068,069,070,101,102	TECHNICS	001,033,049,091
AOC	091	MTC	072	TEKNIKA	001,025,033
AUDIODYNAMIC	019,047,092	MULTITECH	044,057,069	TOSHIBA	006,051
BELL&HOWELL (M.WARDS)	048,093	NEC	019,047,052,057,092	TOTEVISION	025,072
BROKSONIC	092,094,095	OLYMPIC	049,091	TAEKWANG	087
CANON	001,033,049,091	OPTIMUS	101	UNITECH	072
CAPEHART	011	ORION	103	VECTORRESEARCH	019
CITIZEN	050	PANASONIC	001,004,033,049,067,091,107	VIDEOCONCEPTS	019
CRAIG	050,072,096	PENNEY	019,020,072	VIDEOSONIC	072
CRITERION	051	PENTAX	001,020,021,033,062	WARDS	001,020,031,032,033,043,050,054,072,100,105,106,109
CURTISMATHES	001,031,032,033,044,091	PHILCO	001,033,046,049,091,094	YAMAHA	019,047,048,052,092
DAEWOO	006,007,008,009,010,011,012,013,014,015,016,017,018,046,051,091	PHILIPS	001,030,033,049,050,066,091	ZENITH	019,047,048,052,092
DAYTRON	011	PILOT	025	DVD Brand Code List	
DBX	019,047,052,092	PIONEER	049		
EMERSON	025,031,032,044,046,094,095,097,098,099	PORTLAND	011	Brand	Code Number
FISHER	009,048,053,054,055,100	QUASAR	001,033,049,067,091,107,108	DENON	003,032
FUNAI	044	RICO	036	DOONON	019
GENERALELECTRIC (GE)	001,031,032,033,056,091	RCA/PROSCAN	001,020,021,031,032,033,049,051,062,066,070,091,104	DMTECH	017
GOVIDEO	059,060,061	REALISTIC	001,009,025,033,044,048,054,091,101,105	FISHER	002
HARMANKARDON	019	SAMSUNG	000,006,031,032,057,058,071,072,073,074,075,076,077,078,079,080,081	GE	006
HITACHI	020,021,049,054,062,100	SANYO	008,009,046,048,050,054,058,093,100	HARMANKARDON	012
HQ	051	SANSUI	092	JVC	010,013
INSTANTREPLAY	001,033,049,091	SCOTT	006,051,054,057,069,070,100,101	KENWOOD	008
JCL	001,033	SEARS	020,021,025	LG	001
JCP	025	SHARP	043,105,106	MAGNAVOX	004
JCPENNY	047,048,052,062,091,092	SINGER	096	MITSUBISHI	005,016
JVC	001,033,047,052,063,064,065,092	SIGNATURE2000 (M.WARDS)	043,044,054,100,106	ONKYO	004,014
KENWOOD	047,050,052,092	SHINTOM	096	OPTIMUS	011
LG (GOLDSTAR)	019,020,021,022,023,024,025,026,027,028,029,030,050	SONY	034,035,036,037,038,039,040,041,042,082,083,084,085,086	PANASONIC	021
LXI (SEARS)	020,025,044,048,050,053,054,055,062,100	STS	020	PROSCAN	006
MAGIN	072	SYLVANIA	001,033,044,049,066,091	PHILIPS	004,023
MAGNAVOX	001,031,032,033,049,066,067,091	SYMPHONIC	044	PIONEER	007,011,022,025
MARANTZ	001,019,033,047,052,092,110	TANDY	009	RCA	006
MARTA	025,050			SAMSUNG	000,027
				SANYO	002
				SONY	015, 020
				THETADIGITAL	011
				TOSHIBA	004, 018
				YAMAHA	009, 033
				ZENITH	004, 024
				TAEGWANG	026
				PS2	028
				X-BOX	029
				APEX	030
				MARANTZ	031



Before calling for service

Symptom	Check	Remedy
The unit will not turn on.	• Is the power cord plugged into the outlet?	• Connect the power plug to the outlet.
A function does not work when the button is pressed.	• Is there static electricity in the air?	• Disconnect the power plug and connect it again.
Sound is not produced.	• Are the speakers and external components connected properly? • Is the Mute function on? • Is the volume set to minimum? • Is the speaker setup set incorrectly to NONE?	• Connect them correctly. • Press Mute button to cancel the function. • Adjust the volume. • Refer to pages 20~21 to select LARGE, SMALL or YES.
Picture does not appear on a TV when the function is selected.	• Is the external component connected properly?	• Connect it correctly.
Remote controller does not work.	• Are the batteries drained? • Is the distance between remote control and main unit too great?	• Replace with new batteries. • Operate at close distance.
The sound from the left/right channels is reversed.	• Are the left/right speaker or left/right input/output cables connected properly?	• Check the left/right channel and connect it/them correctly.
Can't receive radio broadcasts.	• Is FM antenna connected properly?	• Connect the antenna correctly. • If the input strength of antenna signal is weak, install the FM antenna in a place with good reception.
There is no sound from surround speakers.	• Is the surround speaker connected properly? • Is SURR (surround) incorrectly set to NONE in speaker setup? • Is surround mode set to stereo?	• Refer to pages 10~11 to connect them properly. • Refer to pages 20~21 to select LARGE or SMALL. • Refer to pages 29~35 to select proper Surround Mode.
There is no sound from center speaker	• Is the center speaker connected properly? • Is CEN (center) incorrectly selected to NONE in speaker setup? • Is the surround mode selected to stereo?	• Refer to pages 10~11 to connect it properly. • Refer to pages 20~21 to select LARGE or SMALL. • Refer to pages 29~35 to select other Surround Modes.

MISCELLANEOUS



Before calling for service (cont'd)



Specifications

Symptom	Check	Remedy
There is no sound from surround back speakers	<ul style="list-style-type: none"> Are the surround back speakers connected properly? Is the S.BACK(Surround Back) selected to NONE in Speaker Setup? Is Surround Mode set to EX/ES? 	<ul style="list-style-type: none"> Refer to pages 10~11 to connect it properly. Refer to pages 20~21 to select LARGE or SMALL. Refer to page 32 to set Surround Mode to EX/ES.
Can't select EX/ES mode.	<ul style="list-style-type: none"> Is S.BACK(Surround Back) selected to NONE in Speaker Setup? Is the input signal selected properly? 	<ul style="list-style-type: none"> Refer to pages 20~21 to select LARGE or SMALL. Use 7.1 channel external component.
Can't select Dolby Pro Logic IIx mode.	<ul style="list-style-type: none"> Is the input signal selected properly? 	<ul style="list-style-type: none"> Select 2 channel Dolby Digital, PCM, and Analog input signal.
Can't select NEO:6 mode.	<ul style="list-style-type: none"> Is the input signal selected properly? 	<ul style="list-style-type: none"> Use PCM and Analog input signal.
There is no sound when playing a DTS encoded DVD.	<ul style="list-style-type: none"> Is Digital input selected? 	<ul style="list-style-type: none"> Check whether the DVD player is properly connected and refer to page 23 to select the digital input.

Product protection function

Heat protection

- The protection function will come on if the main unit or power transformer overheats.
- "PROTECTION" will appear in the display .
- This function will come on :
 - If speaker terminal is shorted
 - If speaker cable is shorted
- If there is no problem when you turn the unit on again after turning it off, PROTECTION mark will disappear on the display and the unit will work properly.



Note

- If PROTECTION appears on the display, check whether the speaker terminal is shorted and then turn on the unit

GENERAL	Power supply	120V, 60 Hz	
	Standby power consumption	0.9W	
	Power consumption	Main unit	100W
		Subwoofer	90W
	Weight	12.7 lbs	
	Dimensions (W x H x D)	16.9 x 5.7 x 13.7 inches	
	Operating temperature range	41°F~+95°F	
Operating humidity range	10%~75%		
FM TUNER	Frequency response	87.5~108.0MHz	
	Usable sensitivity	12dBf	
	S/N ratio	MONO/STEREO 55/55dB	
	Distortion	MONO/STEREO 0.3/0.8%	
	Stereo separation	30dB	
	Tuner output level	1kHz, 75kHz Dev	
AMPLIFIER	Rated output	20Hz~20kHz/THD = 10%	
	Front speaker(left+right)	4 Ω 100W/CH	
	Center speaker	4 Ω 100W/CH	
	Surround speaker(left+right)	4 Ω 100W/CH	
	Surround back	4 Ω 100W/CH	
	Input sensitivity/impedance	450mV/47kΩ	
	S/N ratio (analog input)	80dB	
	Separation (1kHz)	60dB	
FREQUENCY RESPONSE	Analog input	20Hz~20kHz(±3dB)	
	Digital input/96kHz PCM	20Hz ~44kHz(±3dB)	
VIDEO OUTPUT	TV format	NTSC/PAL	
	Input level/impedance	1Vp-p/75 Ω	
	Output level/impedance	1Vp-p/75 Ω	
	Video frequency response	5Hz to 10kHz(-3dB)	
	S/N ratio	60dB	

SPEAKERS	Speaker system	Front / Surround	Center	Subwoofer speaker
	Impedance	4Ω x 4	4Ω	8Ω
	Rated input	100W	100W	150W
	Maximum input	200W	200W	300W
	Dimensions (W x H x D)	3.9 x 10.6 x 3.8 inches	11.8 x 3.5 x 3.7 inches	12 x 15.6 x 17.4 inches
	Weight	3.1 lbs / 2.6 lbs	3.1 lbs	31.7 lbs

* S/N ratio, distortion, separation and usable sensitivity are based on measurement using AES (Audio Engineering Society) guidelines.

MISCELLANEOUS

Samsung Limited Warranty

Samsung Electronics Canada Inc.(SECA), warrants that this product is free from defective material and workmanship.

SECA further warrants that if this product fails to operate properly within the specified warranty period and the failure is due to improper workmanship or FM TUNER defective material SECA will repair or replace the product at its option.

All warranty repairs must be performed by a SECA authorized service centre. (The name and address of the location nearest you can be obtained by calling toll free 1-800-726-7864 or visiting our web site at www.samsung.ca)

Labour

 one (1)year (carry-in)

Parts

 one (1)year

On carry-in models, transportation to and from the service centre is the customer's responsibility.

The original dated sales receipt must be retained by the customer and is the only acceptable proof of purchase. It must be presented to the authorized service centre at the time service is requested.

Exclusions

This warranty does not cover damage due to accident, fire flood and/or other acts of God; misuse, incorrect line voltage, improper installation, improper or unauthorized repairs, commercial use, or damage that occurs in shipping. Exterior and interior finish, lamps and glass are not covered under this warranty. Customer adjustments which are explained in the instruction manual are not covered under the terms of this warranty.

This warranty will automatically be voided for any unit found with a missing or altered serial number. This warranty is valid only on products purchased and used in Canada.

Contact SAMSUNG WORLD WIDE

If you have any questions or comments relating to Samsung products, please contact the SAMSUNG customer care center.

Region	Country	Customer Care Center ☎	Web Site
North America	CANADA	1-800-SAMSUNG(726-7864)	www.samsung.com/ca
	MEXICO	01-800-SAMSUNG(726-7864)	www.samsung.com
	U.S.A	1-800-SAMSUNG(726-7864)	www.samsung.com
Latin America	ARGENTINE	0800-333-3733	www.samsung.com/ar
	BRAZIL	0800-124-421 , 4004-0000	www.samsung.com
	CHILE	800-SAMSUNG(726-7864)	www.samsung.com/cl
	NICARAGUA	00-1800-5077267	
	HONDURAS	800-7919267	
	COSTA RICA	0-800-507-7267	www.samsung.com/latin
	ECUADOR	1-800-10-7267	www.samsung.com/latin
	EL SALVADOR	800-6225	www.samsung.com/latin
	GUATEMALA	1-800-299-0013	www.samsung.com/latin
	JAMAICA	1-800-234-7267	www.samsung.com/latin
	PANAMA	800-7267	www.samsung.com/latin
	PUERTO RICO	1-800-682-3180	www.samsung.com/latin
	REP. DOMINICA	1-800-751-2676	www.samsung.com/latin
	TRINIDAD & TOBAGO	1-800-SAMSUNG(726-7864)	www.samsung.com/latin
VENEZUELA	0-800-100-5303	www.samsung.com/latin	
COLOMBIA	01-8000112112	www.samsung.com.co	
Europe	BELGIUM	0032 (0)2 201 24 18	www.samsung.com/be
	CZECH REPUBLIC	844 000 844 Distributor pro Českou republiku: Samsung Zrt., česká organizační složka Vyskočilova 4, 14000 Praha 4	www.samsung.com/cz
	DENMARK	70 70 19 70	www.samsung.com/dk
	FINLAND	030-6227 515	www.samsung.com/fi
	FRANCE	3260 SAMSUNG (€ 0,15/Min), 08 25 08 65 65 (€ 0,15/Min)	www.samsung.com
	GERMANY	01805 - SAMSUNG(726-7864) (€ 0,14/Min)	www.samsung.com
	HUNGARY	06-80-SAMSUNG(726-7864)	www.samsung.com
	ITALIA	800-SAMSUNG(726-7864)	www.samsung.com
	LUXEMBURG	0035 (0)2 261 03 710	www.samsung.com/be
	NETHERLANDS	0900-SAMSUNG(726-7864) (€ 0,10/Min)	www.samsung.com/nl
	NORWAY	815-56 480	www.samsung.com/no
	POLAND	0 801 801 881 , 022-607-93-33	www.samsung.com/pl
	PORTUGAL	80820-SAMSUNG(726-7864)	www.samsung.com/pt
	SLOVAKIA	0800-SAMSUNG(726-7864)	www.samsung.com/sk
	SPAIN	902 10 11 30	www.samsung.com
	SWEDEN	0771-400 200	www.samsung.com/se
	U.K	0845 SAMSUNG (7267864)	www.samsung.com
	EIRE	0818 717 100	www.samsung.com/ie
	AUSTRIA	0800-SAMSUNG(726-7864)	www.samsung.com/at
	SWITZERLAND	0800-SAMSUNG(726-7864)	www.samsung.com/ch
CIS	RUSSIA	8-800-555-55-55	www.samsung.com
	KAZAHSTAN	8-10-800-500-55-500	www.samsung.kz
	UZBEKISTAN	8-10-800-500-55-500	www.samsung.uz
	KYRGYZSTAN	00-800-500-55-500	
	TADJIKISTAN	8-10-800-500-55-500	
	UKRAINE	8-800-502-0000	www.samsung.com
	LITHUANIA	8-800-77777	www.samsung.lt
	LATVIA	800-7267	www.samsung.com/lv
	ESTONIA	800-7267	www.samsung.ee
	AUSTRALIA	1300 362 603	www.samsung.com
Asia Pacific	NEW ZEALAND	0800SAMSUNG(726-7864)	www.samsung.com/nz
	CHINA	800-810-5858 , 010-6475 1880	www.samsung.com
	HONG KONG	3698-4698	www.samsung.com/hk
	INDIA	3030 8282 , 1800 110011	www.samsung.com
	INDONESIA	0800-112-8888	www.samsung.com
	JAPAN	0120-327-527	www.samsung.com/jp
	MALAYSIA	1800-88-9999	www.samsung.com/my
	PHILIPPINES	1800-10-SAMSUNG(726-7864)	www.samsung.com/ph
	SINGAPORE	1800-SAMSUNG(726-7864)	www.samsung.com
	THAILAND	1800-29-3232 , 02-689-3232	www.samsung.com
	TAIWAN	0800-329-999	www.samsung.com/tw
	VIETNAM	1 800 588 889	www.samsung.com
Middle East & Africa	TURKEY	444 77 11	www.samsung.com
	SOUTH AFRICA	0860-SAMSUNG(726-7864)	www.samsung.com
	U.A.E	800-SAMSUNG (726-7864), 8000-4726	www.samsung.com

Free Manuals Download Website

<http://myh66.com>

<http://usermanuals.us>

<http://www.somanuals.com>

<http://www.4manuals.cc>

<http://www.manual-lib.com>

<http://www.404manual.com>

<http://www.luxmanual.com>

<http://aubethermostatmanual.com>

Golf course search by state

<http://golfingnear.com>

Email search by domain

<http://emailbydomain.com>

Auto manuals search

<http://auto.somanuals.com>

TV manuals search

<http://tv.somanuals.com>