

MX-HS9000

PREMIUM HI-FI Component System

user manual

imagine the possibilities

Thank you for purchasing this Samsung product.

To receive more complete service,
please register your product at
www.samsung.com/register

The Samsung logo, consisting of the word "SAMSUNG" in a bold, sans-serif font, is enclosed within a black oval shape.

This Nanum Gothic Eco font is provided by NAVER.

Download from Www.Somanuals.com. All Manuals Search And Download.

Safety Information

Warning

TO REDUCE THE RISK OF ELECTRIC SHOCK, DO NOT REMOVE THE COVER (OR BACK). NO USER-SERVICEABLE PARTS ARE INSIDE. REFER SERVICING TO QUALIFIED SERVICE PERSONNEL.

CAUTION

RISK OF ELECTRIC SHOCK DO NOT OPEN

CAUTION: TO PREVENT ELECTRIC SHOCK, MATCH WIDE BLADE OF PLUG TO WIDE SLOT, FULLY INSERT.



This symbol indicates "dangerous voltage" inside the product that presents a risk of electric shock or personal injury.



This symbol indicates important instructions accompanying the product.

WARNING

- To reduce the risk of fire or electric shock, do not expose this appliance to rain or moisture.
- This product contains chemicals known to the State of California to cause cancer and reproductive toxicity.

CLASS 1 LASER PRODUCT

This Compact Disc player is classified as a CLASS 1 LASER product. Use of controls, adjustments or performance of procedures other than those specified herein may result in hazardous radiation exposure.

Complies with 21CFR 1040.10 except for deviations pursuant to Laser Notice No. 50, dated June 24, 2007.

DANGER :

- VISIBLE AND INVISIBLE LASER RADIATION WHEN OPEN. AVOID DIRECT EXPOSURE TO BEAM. (FDA 21 CFR)

CAUTION :

- CLASS 3B VISIBLE AND INVISIBLE LASER RADIATION WHEN OPEN. AVOID EXPOSURE TO THE BEAM. (IEC 60825-1)

- THIS PRODUCT UTILIZES A LASER. USE OF CONTROLS OR ADJUSTMENTS OR PERFORMANCE OF PROCEDURES OTHER THAN THOSE SPECIFIED HEREIN MAY RESULT IN HAZARDOUS RADIATION EXPOSURE. DO NOT OPEN COVER AND DO NOT REPAIR YOURSELF. REFER SERVICING TO QUALIFIED PERSONNEL.

CLASS 1	LASER PRODUCT
KLASSE 1	LASER PRODUKT
LUOKAN 1	LASER LAITE
CLASS 1	LASER APPARAT
PRODUCTO	LÁSER CLASE 1

FCC NOTES (for U.S.A)

This equipment has been tested and found to comply with the limits for a Class B digital device, pursuant to Part 15 of the FCC rules. These limits are designed to provide reasonable protection against harmful interference in a residential installation. This equipment generates, uses and can radiate radio frequency energy and, if not installed and used in accordance with the instructions, may cause harmful interference to radio or television reception, which can be determined by turning the equipment off and on.

If interference is present, the user is encouraged to try to correct the interference by one or more of the following measures:

- Reorient or relocate the receiving antenna.
- Increase the separation between the equipment and receiver.
- Connect this equipment to an outlet that is on a circuit that is different than the circuit the receiver is connected to.
- Consult the dealer or an experienced radio/TV technician for help.

This class B digital product meets all requirements of the Canadian Interference - Causing Equipment Regulations.

Important Safety Instructions

Read these operating instructions carefully before using the unit. Follow all the safety instructions listed below. Keep these operating instructions handy for future reference.

1. Read these instructions.
2. Keep these Instructions.
3. Heed all warnings.
4. Follow all instructions.
5. Do not use this apparatus near water.
6. Clean only with dry cloth.
7. Do not block any ventilation openings. Install in accordance with the manufacturer's instructions.

8. Do not install near any heat sources such as radiators, heat registers, stoves, or other apparatus (including amplifiers) that produce heat.
9. Do not defeat the safety purpose of the polarized or grounding type plug. A polarized plug has two blades with one wider than the other. A grounding type plug has two blades and a third grounding prong. The wide blade or the third prong are provided for your safety. If the provided plug does not fit into your outlet, consult an electrician for replacement of the obsolete outlet.
10. Protect the power cord from being walked on or pinched particularly at plugs, convenience receptacles, and the point where they exit from the apparatus.
11. Only use attachment/accessories specified by the manufacturer.
12. Use only with the cart, stand, tripod, bracket, or table specified by the manufacturer, or sold with the apparatus. When a cart is used, use caution when moving the cart/apparatus combination to avoid injury from tip-over.
13. Unplug this apparatus during lightning storms or when unused for long periods of time.
14. Refer all servicing to qualified service personnel. Servicing is required when the apparatus has been damaged in any way, such as when the power-supply cord or plug is damaged, liquid has been spilled or objects have fallen into the apparatus, the apparatus has been exposed to rain or moisture, does not operate normally, or has been dropped.



Safety Information

Precautions

- Ensure that the AC power supply in your house complies with the identification sticker located on the back of your product.
- Install your product horizontally, on a suitable base (furniture), with enough space around it for ventilation (3 - 4 inches/7.5 - 10 cm).
- Do not place the product on amplifiers or other equipment which may become hot. Make sure the ventilation slots are not covered.
- Do not stack anything on top of the product.
- Before moving the product, ensure the Disc Insert Slot is empty.
- To turn off the product completely, disconnect the AC plug from the wall outlet. Disconnect the AC plug from the wall outlet if you will leave the device unused for a long period of time.
- During thunderstorms, disconnect the AC plug from the wall outlet. Voltage spikes due to lightning could damage the product.
- Do not expose the product to direct sunlight or other heat sources. This could cause the product to overheat and malfunction.
- Protect the product from moisture, excess heat, and equipment creating strong magnetic or electric fields (i.e. speakers.).
- Disconnect the power cable from the AC supply if the product malfunctions.
- Your product is not intended for industrial use. It is for personal use only.
- Condensation may occur if your product or disc has been stored in cold temperatures. If transporting the product during the winter, wait approximately 2 hours until the product has reached room temperature before using.
- The batteries used with this product contain chemicals that are harmful to the environment. Do not dispose of batteries in the general household trash.
- Please check the volume level before playing not to startle the elderly, infirm and pregnant woman at a sudden loud sound.

- Place the loudspeakers at a reasonable distance on either side of the system to ensure good stereo sound.
- Direct the loudspeakers towards the listening area.
- Do not expose this apparatus to dripping or splashing. Do not place objects filled with liquids, such as vases, on the apparatus.
- To turn this apparatus off completely, you must disconnect it from the wall outlet. Consequently, the wall outlet and power plug must be readily accessible at all times.
- Use only a properly grounded plug and receptacle.
 - An improper ground may cause electric shock or equipment damage. (Class I Equipment only.)

Disc Storage & Management

- Holding Discs
 - Fingerprints or scratches on a disc may reduce sound and picture quality or cause skipping.
 - Avoid touching the surface of a disc where data has been recorded.
 - Hold the disc by the edges so that fingerprints will not get on the surface.
 - Do not stick paper or tape on the disc.
- Cleaning Discs
 - If you get fingerprints or dirt on a disc, clean it with a mild detergent diluted in water and wipe with a soft cloth.
 - When cleaning, wipe gently from the inside to the outside of the disc.
- Disc Storage
 - Do not keep in direct sunlight.
 - Keep in a cool ventilated area.
 - Keep in a clean protection jacket and store vertically.



Disc and Format Compatibility

This product does not support Secure (DRM) Media files.

CD-R Discs

- Some CD-R discs may not be playable depending on the disc recording device (CD-Recorder or PC) and the condition of the disc.
- Use 650MB/74 minute CD-R discs. Do not use CD-R discs over 700MB/80 minutes as they may not be played back.
- Some CD-RW (Rewritable) media may not be playable.
- Only CD-Rs that are properly "closed" can be fully played. If the session is closed, but the disc is left open, you may not be able to fully play the disc.

MP3-CD Discs

- Only CD-R discs with MP3 files in ISO 9660 or Joliet format can be played.
- MP3 file names should contain no blank spaces or special characters (. / = +).
- Use discs recorded with a compression/decompression data rate greater than 128Kbps.
- Only a consecutively written multisession disc can be played. If there is a blank segment in the Multisession disc, the disc can be played only up to the blank segment.
- If the disc is not closed, it will take longer to begin playback and not all of the recorded files may play.
- For files encoded in the Variable Bit Rate (VBR) format, (i.e. files encoded in both low bit rate and high bit rate - 32Kbps ~ 320Kbps), the sound may skip during playback.
- A maximum of 999 files can be played per CD.

Supported Audio Formats

File Extension	Audio Codec	Sampling Rate	Bit Rate
*.mp3	MPEG 1 Layer3	16KHz ~ 48KHz	80Kbps ~ 320Kbps
	MPEG 2 Layer3	16KHz ~ 48KHz	80Kbps ~ 320Kbps
	MPEG 2.5 Layer3	16KHz ~ 48KHz	80Kbps ~ 320Kbps
*.wma	Wave_Format_MSAudio1	16KHz ~ 48KHz	56Kbps ~ 128Kbps
	Wave_Format_MSAudio2	16KHz ~ 48KHz	56Kbps ~ 128Kbps

NOTES

- Does not support WMA Professional codec.
- The above table shows supported sampling rates and bit rates. Files of not supported formats may not be played properly.

Contents

SAFETY INFORMATION

- 2 **Warning**
- 4 **Precautions**
- 4 **Disc Storage & Management**
- 5 **Disc and Format Compatibility**
- 5 **Supported Audio Formats**

GETTING STARTED

- 7 **Front Panel**
- 8 **Rear Panel**
- 9 **Remote Control**
- 10 **Accessories**
- 10 **Connecting the Speakers**
- 10 **Cautions on Moving the Speakers**
- 10 **Attaching the Speaker foot**

FUNCTIONS

- 11 **The Display function**
 - 11 Changing Display mode
 - 11 The DEMO function
- 11 **Playing a CD**
 - 11 Loading a Compact Disc
 - 11 CD/MP3/CD-R Playback
 - 12 Selecting a Track
 - 12 Searching for a Specific Music Passage on a CD
 - 12 Repeat One or All Tracks on a CD
- 13 **Playing USB Devices**
 - 13 USB Device Playback
 - 13 To Select a File from a USB Device
 - 14 To Use High Speed Search
 - 14 To Delete a File
 - 14 To Move to the Next/Previous Folder
 - 14 To safely remove a USB device
 - 14 Read Before Connecting USB Storage Devices
 - 15 Searching for a Track Quickly
 - 15 Using the Program Function
 - 15 Viewing or Editing Programmed Tracks
- 16 **Bluetooth**
 - 16 What is Bluetooth?

- 16 To connect the Hi-Fi Component to a Bluetooth device
- 17 To disconnect the Bluetooth device from the Hi-Fi Component
- 17 To disconnect the Hi-Fi Component from the Bluetooth device
- 17 Using Bluetooth Power On
- 18 **TV SoundConnect**
 - 18 To connect the Hi-Fi Component to a SoundConnect Compatible Samsung TV
 - 18 To disconnect the TV from the Hi-Fi Component
 - 18 To disconnect the Hi-Fi Component from the TV
- 19 **Using My Karaoke**
- 19 **Auto Change Function**
- 19 **Listening to the Radio**
 - 19 To Store the Stations You Want
 - 20 Selecting a Stored Station
- 20 **Timer Function**
 - 20 Setting the Clock
 - 20 Setting the Timer
 - 22 Cancelling the Timer
- 22 **The Recording Function**
 - 22 Basic Recording
 - 23 Recording Speed
- 24 **Special Sound Effects**
 - 24 Selecting EQ Mode
 - 24 FOOTBALL MODE function
 - 24 GOAL Function
 - 25 GIGA SOUND Function
 - 25 BEAT WAVING Function
 - 25 DJ BEAT Function
 - 26 +PANNING Function
 - 26 NON-STOP MUSIC RELAY Function
 - 26 DANCE TIME Function
 - 26 TEMPO Function

APPENDIX

- 27 **Troubleshooting**
- 28 **Specifications**

Getting Started

Front Panel

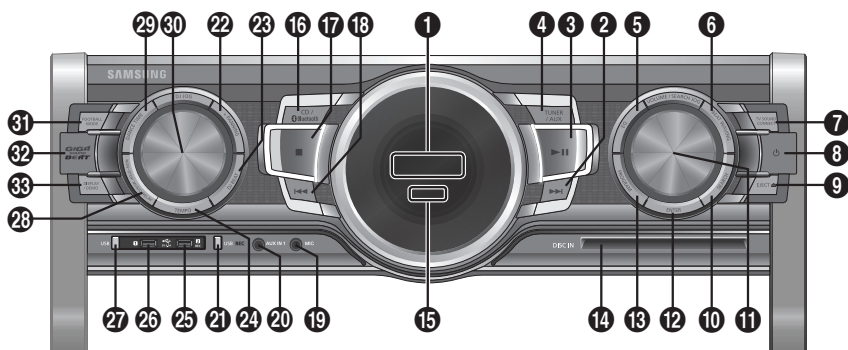

1	Display Panel
2	FORWARD SEARCH/SKIP button
3	PLAY/PAUSE button
4	TUNER/AUX button
5	EQ button
6	BEAT WAVING button
7	TV SOUNDCONNECT button
8	POWER button • Press this button to switch your product on or off.
9	Eject button for Disc
10	SEARCH button
11	VOLUME/SEARCH JOG
12	ENTER button
13	PROGRAM button
14	DISC slot
15	REMOTE CONTROL SENSOR
16	CD/ Bluetooth button
17	STOP button
18	BACKWARD SEARCH/SKIP button

19	MIC jack
20	AUX IN 1 jack Use to connect an external device such as an MP3 player. • Connect AUX IN 1 on the front panel of the product to the Audio Out of an external device/MP3 player. • Press the TUNER/AUX button to select AUX1.
21	USB REC button
22	+PANNING button
23	DJ BEAT button
24	TEMPO button
25	USB 2 jack for Playing and USB Recording
26	USB 1 jack for Playback only.
27	USB button
28	NON-STOP MUSIC RELAY button
29	DANCE TIME button
30	DJ JOG
31	FOOTBALL MODE button
32	GIGA SOUND BEAT button
33	DISPLAY / DEMO button

Getting Started

Rear Panel

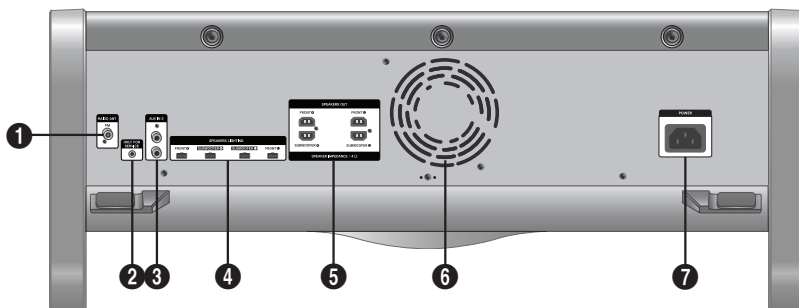

1	<p>FM Antenna Terminals</p> <ol style="list-style-type: none"> Connect the FM antenna to the FM antenna connector terminal. Slowly move the antenna wire until you find a location where reception is good, then fasten it to a wall or other rigid surface. If reception is poor, you may need to install an outdoor antenna. To do so, connect an outdoor FM antenna to the FM socket on the rear of the system using a 75Ω coaxial cable (not supplied).
2	<p>ONLY FOR SERVICE</p> <ul style="list-style-type: none"> This jack is for testing only. Please do not use.
3	<p>AUX IN 2 Terminals</p> <ol style="list-style-type: none"> Use an Audio Cable (not supplied) to connect AUX IN 2 on the product to Audio Out on an external analog output device. <ul style="list-style-type: none"> Be sure to match connector colors. If the external analog output device has only one Audio Out jack, connect either left or right. Press the TUNER/AUX button to select AUX 2. If the product is in AUX mode for more than eight hours and no buttons on the front panel or remote are pushed, the system will turn off.

4	<p>LED Terminals for Speaker Beat Waving.</p> <p>2.2 CH Speaker Terminals</p> <ol style="list-style-type: none"> To achieve the correct sound quality, when you connect the speakers, match the color of the speaker plugs to the color of the speaker jacks. See below. <ul style="list-style-type: none"> LEFT channel (marked L, White/Purple). RIGHT channel (marked R, Red/Purple). Don't force the Purple SUBWOOFER connector into the White or Red speaker jack.
6	<p>Cooling fan</p> <ul style="list-style-type: none"> The fan operates while the unit is powered on. If you set the unit to the minimum volume, the fan won't operate. Secure a minimum 6 inches (15 cm) of clear space on all sides of the fan when installing the product.
7	<p>POWER</p> <ul style="list-style-type: none"> Insert only the provided power cable.

Remote Control

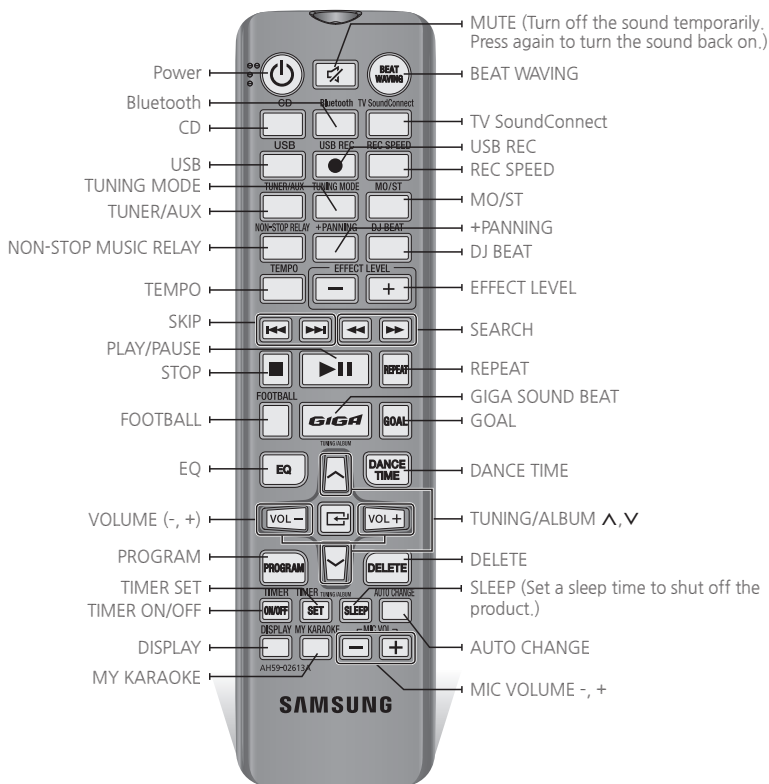

Installing Batteries In The Remote Control



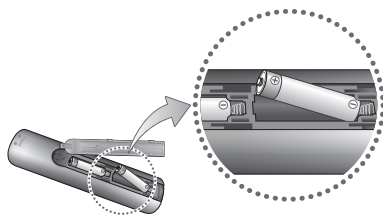

- Place batteries in the remote control so they match the polarity of the illustrations in the battery compartment. : (+) to (+) and (-) to (-).
- Do not dispose of batteries in a fire.
- Do not short circuit, disassemble, or overheat the batteries.
- There is a danger of explosion if the battery is replaced with the wrong battery type. Replace only with the same or equivalent type.
- The remote control can be used up to approximately 23 feet (7 meters) in a straight line from the system.

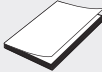

Getting Started

Accessories

Check for the supplied accessories below.

		
User Manual (AH68-02687A)	Remote Control / Batteries (AH59-02613A/4301-000116)	FM Antenna (AH42-00021A)
		
Power Cable (3903-000467)	Rubber Foot (4ea) (AH81-05916L)	

- Figures and illustrations in this user's manual are provided for reference only and may differ from actual product appearance.

Connecting the Speakers

Recommended speaker setup.

IMPORTANT

- ✎ The product may not operate properly if it is subject to shaking or external shocks or if the speakers are not installed as recommended.
- ✎ Do not stretch the speaker wires or place a heavy object on them.



Cautions on Moving the Speakers

- When moving the main unit and speakers, make sure to separate all connected speaker cables before.
- When separating the SPEAKERS LIGHTING cables, press the lock to release the connector as shown below.

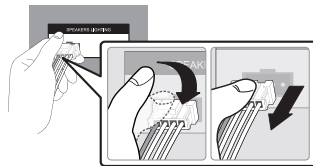

Attaching the Speaker foot

Attach the supplied speaker feet to the bottom rear corners of each speaker as shown in the illustration to stabilize the speakers and prevent them from slipping.

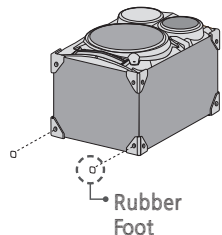

The Display function

You can view functions available on the display, adjust the brightness of the display and set the Display/LED either on or off.

Changing Display mode

Press the **DISPLAY/DEMO** button on the product.

Each time you press this button, the mode will change as follows:

- **The Dimmer function**
The Dimmer function is selected and the display darkens.
- **LED OFF**
The Front display LED is turned off while the dimmer function is working.
- **Clock ON**
The Clock you set is displayed.
- **Display/LED ON**
All displays and the LED are turned on.

The DEMO function

Press the **DISPLAY/DEMO** button for 5 seconds to start the Demo mode.

When you press the **DISPLAY/DEMO** button while displaying the demo, the function operates as follows:

DIMMER → LED Off (unit/speaker) → --:-- [time display] → LED On (unit/speaker)

To cancel the Demo mode

- Press the **DISPLAY/DEMO** again for 5 seconds. The DEMO mode is canceled and the product turns off.
- Press the **TUNER/AUX, CD/Bluetooth, or USB** button. The DEMO mode is canceled and the mode is changed to the mode you selected.

NOTES

- When the DEMO music function is on, only the **POWER (⏻)**, **VOL** buttons and the buttons mentioned above work.

Playing a CD

Loading a Compact Disc

You can play standard compact discs that require no adapter.

1. Insert a disc gently into the disc slot with the disc's label facing up. The disc will be played automatically.
 - You can load or unload compact discs when the radio, USB, or auxiliary source function is selected. When you press the **⏮** button, all the other functions will change to the CD mode.
 - If no buttons are pressed on the product or remote control for more than 3 minutes when the product is in Pause mode, it will change to Stop mode.
 - If no buttons are pressed on the product or remote control for more than 25 minutes when the product is in Stop mode, the product will turn off.

CD/MP3/CD-R Playback

IMPORTANT

• This product is designed to play the following audio disc types: CD, CD-R, CD-RW.





1. Insert a disc gently into the disc slot with the disc's label facing up.
2. The disc is played automatically.
 - For MP3/WMA file, it may take several minutes for the product to finish scanning the disc tracks.
 - If you play a file with an English title, the song title will be shown in the display. (Titles in other languages can not be displayed.)
 - An English-titled track containing a special character (@, \$, *, etc.) will not be displayed.

<CD Playback Display>





Track Indicator — CD Tr 01 — Playtime Indicator
00:00:37



Functions

- To adjust the volume:
 - Turn the **VOLUME** control on the product.
 - Press the **VOL+** or **VOL-** button on the remote control.
The volume level can be adjusted in 31 steps (VOLUME MIN, VOLUME 01 ~ VOLUME 29, and VOLUME MAX).
- PAUSING PLAYBACK**
Main Unit
To pause playback temporarily, press the  button.
Press  again to continue playing the disc.
Remote control
To pause playback temporarily, press the  button.
Press the  button to continue playing the disc.
- To end playing, press the  button.

! NOTES

-  If no CD is in the disc slot, "NO DISC" appears on the display.
-  The quality of MP3/CD-R playback may vary depending on the condition of the disc or the condition of the recorder used to create the disc.
-  If a disc contains different types of files or unnecessary folders, you will have problems with playback.
-  Gently insert a CD into the disc slot. Do not apply excessive force.
 - Do not apply force to the product or place a heavy object on the product.
 - Do not insert an out-of-spec or oddly shaped CD (heart shaped, octangular, etc.).
You can damage the product.
 - Carefully maintain your CDs.

Selecting a Track

You can select a desired track while the disc is being played.

To play the previous track

Press the  button within 3 seconds after the current track has started playing.

Press the  button twice, 3 seconds or more after the current track starts playing.

To play the next track

Press the  button.

To play the current track from the beginning

Press the  button, 3 seconds after the current track started playing.

To play the track of your choice



Press the  or  button to move to a desired track.

Searching for a Specific Music Passage on a CD

When listening to a CD, you can quickly search for a specific music passage on a track.

Forward Search 

Backward Search..... 

You can also press and hold the   buttons on the product to automatically scan for a track.

Repeat One or All Tracks on a CD

You can play a CD or tracks on a CD repeatedly.

- Press the REPEAT button on the remote control.
Each time you press this button, the mode changes as follows:

MP3 : OFF → TRACK → DIR → ALL → RANDOM

CD : OFF → TRACK → ALL → RANDOM

- When you want to stop the repeat function, press the **REPEAT** button until "OFF" is displayed.
 - OFF** : Cancels repeat playback.
 - TRACK** : Repeatedly plays the selected track.
 - DIR (DIRECTORY)** : Repeatedly plays all tracks in the selected folder.
 - ALL** : Repeatedly plays the entire disc.
 - RANDOM** : Plays tracks in random order.

Playing USB Devices

Connect an external storage device such as a USB flash memory or external HDD (Hard Disk Drive) to the product. You can play files in MP3/WMA format.

USB Device Playback

- Connect the external USB storage device to your product.
- Select the USB mode by pressing the **USB** button on the product or the **USB** button on the remote control.
- The first file of the first directory plays automatically.
- To stop playing
Press the **■** button to stop playing.

NOTES

To remove the USB device

- If you press the **■** button again, you can remove the USB device safely.

IMPORTANT

- Do not connect a USB recharger to the USB port of this product. You can damage the product.

To Select a File from a USB Device

You can select an MP3 file while the product is playing.

NOTES

- If you want to move to the previous/next track, press the **◀**, **▶** buttons briefly.
 - The unit moves to the previous/next track within the directory.
 - If you press the **◀**, **▶** buttons more times than the number of the files in the directory, the unit moves to the next directory.

To repeat

- Press the **REPEAT** button.
Each time you press this button, the mode changes as follows:

OFF → TRACK → DIR → ALL → RANDOM

- When you want to stop the repeat function, press the **REPEAT** button until "OFF" is displayed.
 - OFF** : Cancels repeat playback.
 - TRACK** : Repeatedly plays the selected file.
 - DIR (DIRECTORY)** : Repeatedly plays all files in the selected folder.
 - ALL** : Repeatedly plays all files.
 - RANDOM** : Plays files in random order.

NOTES

- If the file selected to be played is located in a folder all the files within that folder are played in random order. If the file selected is located in the root folder all files will be played in random order.

Functions

To Use High Speed Search

You can search a desired section quickly while the product is playing.

Press the **◀▶** button.

- Each time you press the button, you move through the section forward/backward quickly.

! IMPORTANT !

- 🔊 The product does not output sound during a high speed search.
- 🔊 You can also press and hold the **◀◀** or **▶▶** button on the main unit to automatically scan for a track.

To Delete a File

You can delete a file from your USB device.

1. Select a file you want to delete.
2. Press the **DELETE** button on the remote control. "DELETE NO" is displayed.
3. Press the **DELETE** button on the remote control and "DELETE YES" is displayed.
4. Press the **☑** button. "DELETE END" appears and deletion is completed.

To Move to the Next/Previous Folder

Press the **TUNING/ALBUM ▲ / ▼** button on the remote control to move to the previous/next folder.

! NOTES !

- 🔊 When sound files are stored in the root directory rather than in a folder, press the **TUNING/ALBUM ▲ / ▼** button to go to the first TRACK.

To safely remove a USB device

1. Press the **☑** button twice while the USB is playing or press the **☑** button once when play has stopped.
2. When the **REMOVE** message appears on the display, remove the USB device.

Read Before Connecting USB Storage Devices

- Some USB devices may not work properly with this product.
- This product only supports external HDD's that are formatted in the FAT file system.
- USB 2.0 HDDs should be connected to a separate power source. Otherwise, the USB 2.0 HDDs will not work.
- If multiple USB external storage are connected together, only the MP3 files in the first HDD will be played.
- Files with Digital Rights Management (DRM) are not supported. DRM restricts unauthorized access to a DRM file so that file is protected from piracy.
- Even if a file has an .mp3 extension, the file cannot be played if it is formatted in MPEG layer 1 or 2.
- Do not use an unrecognized USB hub.
- Only the first 15 characters of an audio file name are shown on the product's display.
- Only removable HDDs with less than 160GB are supported. Depending on the device, a 160GB- or more removable HDD may not be supported.
- It can take several minutes for the product to recognize the files on some USB devices.
- Some USB devices (USB HDDs, in particular) may cause a delay when moving from track to track.
- With USB storage devices supporting USB VER1.1 only, the product may access files slowly or may not recognize the file properties.
- The maximum electrical current provided by each USB port to connected USB devices is 0.5A (based on DC 5V).
- If there is no USB connection or STOP mode lasts for more than 25 minutes, the product will automatically turn off.
- Some USB devices, digital cameras, USB card readers, iPods, iPhones, and Smart Phones may not be supported.

Searching for a Track Quickly

You can select a track directly without the ,  button.

CDDA/MP3-CD/USB

- Press the **SEARCH** button.
After pressing the **SEARCH** button, turn the **VOLUME/SEARCH JOG** control on the product to the left or right to select a desired track.
 - You can move to the selected track directly.
- When searching is done, the track will automatically start playing.

Using the Program Function









This function is not available during playback of an MP3-CD/USB.

- You can program the playback order of up to 99 tracks of your choice.
- However, you must stop playing the CD/USB before selecting tracks.

- While in CD/USB playback mode, press the  button to stop playing the CD/USB.
- Press the **PROGRAM** button to display the message below:

```
PROG 01 TRACK----
```

(01= program number, ---= track number)

- Use the  or  button or the **VOLUME/SEARCH JOG** to move to a desired track.
 - Press  to move to the previous track.
 - Press  to move to the next track.
- Press the  button to confirm your selection. The selection is stored and **PROG 02 TRACK----** is displayed.
- To select another track, follow Steps 3 and 4 above.
- Press the  button to play the programmed tracks.
- Press the  button to stop playing the programmed tracks, Press the  button again to cancel playing the programmed tracks.

- If you eject the disc, CD programming is cancelled.
If you turn off the product, CD/USB programming is cancelled.

! NOTES !





- CD/USB program play will continue if you try to switch to another mode.
- USB REC, DELETE and TUNING/ALBUM buttons will not work in Program mode. If you press such buttons in Program mode, "PROGRAM PLAY" will be displayed instead.
- If a file in the program to be played was not in a supported format, playback skips to the next file automatically.

Viewing or Editing Programmed Tracks

You can view and edit a list of programmed tracks.

- If a programmed track is being played, press the  button once.
- Press the **PROGRAM** button twice to display the message below:

```
SAVED 01 TRACK002
```

(01= program number, 002= track number)
- Repeatedly press the  button until the desired track is displayed.
- Press the  or  button to select a different track.
- Press the  button to confirm your selection.
- To play the programmed tracks, press the  button.

To repeat

- Press the **REPEAT** button.
Each time you press this button, the mode changes as follows:

OFF → TRACK → ALL

Bluetooth

You can use a Bluetooth device to enjoy music with high quality stereo sound, all without wires!

What is Bluetooth?

Bluetooth is a technology that enables Bluetooth compliant devices to interconnect easily with each other using a short, wireless connection.

- A Bluetooth device may cause noise or malfunction, depending on usage, when:
 - A part of your body is in contact with the receiving/transmitting system of the Bluetooth device or the Hi-Fi Component.
 - It is subject to electrical variation from obstructions caused by a wall, corner, or office partitioning.
 - It is exposed to electrical interference from same frequency-band devices including medical equipment, microwave ovens, and wireless LANs.
- Pair the Hi-Fi Component with the Bluetooth device while they are close together.
- The greater the distance between the Hi-Fi Component and the Bluetooth device, the worse the quality. If the distance exceeds the Bluetooth operational range, the connection is lost.
- In poor reception areas, the Bluetooth connection may not work properly.
- The Bluetooth connection only works when the Bluetooth device and the Hi-Fi Component are close together. The connection will be automatically cut off if the Bluetooth device is out of range. Even within range, the sound quality may be degraded by obstacles such as walls or doors.
- This wireless device may cause electric interference during its operation.

To connect the Hi-Fi Component to a Bluetooth device

Before you begin, confirm that your Bluetooth device supports the Bluetooth-compliant stereo headset function.

1. Press the **CD/Bluetooth** button of the Hi-Fi Component to display the **BLUETOOTH** message.
 - You will see **WAIT** for a short period of time and then **READY** on the front display of the Hi-Fi Component.
2. Select the Bluetooth menu on the Bluetooth device you want to connect. (Refer to the Bluetooth device's user manual.)
3. Select the Stereo headset menu on the Bluetooth device.
 - You will see a list of scanned devices.
4. Select "[Samsung] HI-FI XXXXXX" from the list.
 - When the product is connected to the Bluetooth device, it will display **CONNECTED → BLUETOOTH** on the front display.
 - If the Bluetooth device has failed to pair with the product, delete the previous "[Samsung] HI-FI XXXXXX" found by the Bluetooth device and have it search for the product again.
5. You can listen to the music playing on the connected Bluetooth device over the Hi-Fi Component system.
 - In **Bluetooth** mode, some model's Play/Stop/Next/Back functions are not available.

NOTES

The product only supports Middle Quality SBC data (up to 237kbps@48kHz), and does not support High Quality SBC data (328kbps@44.1kHz).

- 🔌 The AVRCP feature is not supported.
- 🔌 Connect only to a Bluetooth device that supports the A2DP (AV) function.
- 🔌 You cannot connect to a Bluetooth device that supports only the HF (Hands Free) function.

- ✎ Only one Bluetooth device can be paired at a time.
- ✎ Once you have turned off the Hi-Fi Component and the pairing is disconnected, the pairing will not be restored automatically. To reconnect, you must pair the device again.
- ✎ The Hi-Fi Component system may not search or connect properly in the following cases:
 - If there is a strong electrical field around the Hi-Fi Component.
 - If several Bluetooth devices are simultaneously paired with Hi-Fi Component.
 - If the Bluetooth device is turned off, not in place, or malfunctions.
 - Note that such devices as microwave ovens, wireless LAN adaptors, fluorescent lights, and gas stoves use the same frequency range as the Bluetooth device, which can cause electric interference.
- ✎ In Bluetooth connection mode, the Bluetooth connection will be lost if the distance between the Hi-Fi Component and the Bluetooth device exceeds 16.25 feet (5 meters).
- ✎ If the Bluetooth device comes back into the effective range after disconnecting, you can restart the Hi-Fi Component to restore the pairing with the Bluetooth device.
- ✎ The Hi-Fi Component automatically turns off after 25 minutes in the Ready mode.
- ✎ When a Bluetooth device is connected to the Hi-Fi Component system, the Hi-Fi Component System automatically switches to the Bluetooth mode if it was in a different mode.

To disconnect the Bluetooth device from the Hi-Fi Component

You can disconnect the Bluetooth device from the Hi-Fi Component. For instructions, see the Bluetooth device's user manual.

- The Hi-Fi Component will be disconnected.
- When the Hi-Fi Component is disconnected from the Bluetooth device, the Hi-Fi Component displays **DISCONNECTED** → **READY** on its display.

To disconnect the Hi-Fi Component from the Bluetooth device

Press another mode button on the front panel of the Hi-Fi Component to switch from Bluetooth mode to another mode or turn off the Hi-Fi Component. The currently connected device is disconnected.

! NOTES

- ✎ The connected Bluetooth device will wait a certain amount of time for a response from the Hi-Fi Component before terminating the connection. (Disconnection time may differ, depending on the Bluetooth device)

Using Bluetooth Power On

When the product is turned off, you can connect your smart device to the product via a Bluetooth connection to turn it on.

1. Press and hold the Bluetooth button on the remote to set the Bluetooth Power On function On. Bluetooth Power On appears on the display.
2. When the product is off, connect your smart device to the product via Bluetooth. (For information on Bluetooth connections, refer to your smart device's manual.)
3. When the connection is complete, the product turns itself on automatically in Bluetooth mode.
 - Select the desired music to play from your smart device.

! NOTES

- ✎ Press and hold the **Bluetooth** button on the remote control to turn the Bluetooth Power On function on or off. Each time you press and hold this button, the Hi-Fi Component displays **Bluetooth Power On** → **Off** on its display.

Functions

TV SoundConnect

You can listen to the sound from your SoundConnect Compatible Samsung TV through the Hi-Fi Component by using the TV SoundConnect function.

To connect the Hi-Fi Component to a SoundConnect Compatible Samsung TV

Before activating this function, be sure to set the Samsung TV's SoundConnect or SoundShare function to **On**.

1. Press the **TV SoundConnect** button of the Hi-Fi Component to display the TV SOUNDCONNECT message.
WAIT → SEARCH → REQUEST
2. Set **Add New Device** to **On** in the TV's SoundConnect Settings menu. (Refer to the TV's user manual for details.)
3. When the Hi-Fi Component is connected to the TV, it will display **[TV Name → CONNECTED]** on the front display.
4. The audio from the connected TV plays over the Hi-Fi Component system.

NOTES

- The SoundConnect feature is available on some Samsung TVs released since 2012. Check whether your TV supports the SoundShare or SoundConnect function. (For further details, refer to the TV's user's manual.)
- If you unplug the Hi-Fi Component, the TV SoundConnect connection is terminated. To re-establish the connection, plug the Hi-Fi Component into an outlet, and then set the TV SoundConnect connection again.

- Only one Hi-Fi Component can be connected to a TV via TV SoundConnect at time.

- To connect to another TV in TV SoundConnect mode, press the **▶** button for more than 5 seconds, and then connect to the other TV by following the directions above.

To disconnect the TV from the Hi-Fi Component

You can disconnect the TV from Hi-Fi Component.

For instructions, see the TV's user manual.

- When the Hi-Fi Component is disconnected from the TV, the Hi-Fi Component displays **DISCONNECTED → REQUEST** on its display.

To disconnect the Hi-Fi Component from the TV

Press another mode button on the front panel of the Hi-Fi Component to switch from TV SoundConnect mode to another mode or turn off the Hi-Fi Component. The currently connected device is disconnected.

NOTES

- The connected TV will wait a certain amount of time for a response from the Hi-Fi Component before terminating the connection. (Disconnection time may differ, depending on the TV)
- The connection may be lost or sound may stutter if the distance between the TV and the Hi-Fi Component exceeds 6.5 feet (2 m).
- Instability in the network environment may cause the connection to be lost or sound to stutter.
- The Hi-Fi Component automatically turns off after 25 minutes if it is not connected to a TV.

Using My Karaoke

You can use the MY Karaoke function to sing along with your favorite CDs and USB tracks.

1. Connect the microphone to the MIC jack on the front of the product.
 - If your microphone plug is smaller than the 6.3mm MIC jack, you need a Connector-Adaptor (not supplied) to complete the connection.
 - First, connect the Connector-Adaptor to the MIC jack on the front of the product,
 - Second, connect the microphone (with larger jack) to the Connector-Adaptor.
2. Press the **MIC VOL-**, **+** button on the remote control to adjust the volume of the microphone.
3. Press the **MY KARAOKE** button on the remote control to suppress the vocal if you need to. Each time you press the button, the selection changes as follows:

MY KARAOKE ON → MY KARAOKE OFF

- If you hear strange noises (squealing or howling) while using the Karaoke feature, move the microphone away from the speakers. Turning down the microphone's volume or the speaker volume is also effective. Do not aim the MICROPHONE towards the SPEAKERS.
- The microphone does not operate in the AUX and TUNER mode.
- If you connect a microphone, GIGA SOUND automatically turns off. To turn Giga Sound back on you must remove the microphone, and then press the **GIGA SOUND BEAT** button.
- When My Karaoke is on, GIGA SOUND does not work.
- When you turn My Karaoke off, all My Karaoke settings are lost.
- My Karaoke is only available when a microphone is connected to the Hi-Fi Component.
- My Karaoke does not operate in the Bluetooth, TV SoundConnect, FM and AUX mode.

Auto Change Function

You can circularly play between the disc and the USB.

1. Press the **AUTO CHANGE** button to select a mode and press **OK** to apply your selection.
 - If Program Play has not been set in CD/USB

AUTO CHANGE OFF → AUTO CHANGE ALL

- If Program Play has been set in CD/USB

AUTO CHANGE OFF → AUTO CHANGE ALL → AUTO CHANGE PROGRAM

- When the **AUTO CHANGE** mode is "ALL",
 - the music will be played on **DISC → USB1 → USB2** continuously.
 - if you press the **POWER** button, function change button or the **EJECT** button, the **AUTO CHANGE** function automatically switches to "OFF" mode.
 - the recording can't work.
 - the **REPEAT** function can't work and automatically changes to **OFF**.
 - the **REC SPEED**, **USB REC** button can't work.
- When USB is playing, if you disconnected the USB, the **AUTO CHANGE** function automatically switches to "OFF" mode.
- If there's no USB1, it will jump to USB2.

Listening to the Radio

To Store the Stations You Want

You can store up to:
15 FM stations.

1. Select **FM** by pressing the **TUNER/AUX** button.
2. To search for a station, press the **TUNING MODE** button on the remote control or the **■** button on the product one or more times until **MANUAL** is displayed.

Functions

- Find a station by:
 - Pressing and holding the **TUNING/ALBUM** \blacktriangle or \blacktriangledown button on the remote control to automatically search for broadcasting stations.
- Press the **MO/ST** button to switch between stereo and mono.
 - In a poor reception area, select **MONO** for a clear, interference-free broadcast.
 - This applies only when listening to an FM station.
- If you do not want to store the radio station found, go back to Step 3 and search for another station.

Otherwise:

- Press the \square button.
 - Or, press the **TUNING/ALBUM** button on the remote control to select a program number in the **PRESET** mode.
 - Press the \square button to save the preset.
- To store other radio frequencies, repeat Steps 3 to 5.

NOTES

In Tuner mode

- In the Manual mode, you can use the \blacktriangleleft or \blacktriangleright button or the **DJ JOG** control.
- In the Preset mode, you can use the \blacktriangleleft or \blacktriangleright button or the **DJ JOG** control on the product to search a stored radio station.

Selecting a Stored Station

To listen to a stored station, follow these steps:

- Select **FM** by pressing the **TUNER/AUX** button on the product or remote control.
- Press the **TUNING MODE** button on the remote control until "PRESET" is displayed.
- Press the \blacktriangleleft , \blacktriangleright buttons on the main unit or the **TUNING/ALBUM** \blacktriangle , \blacktriangledown buttons on the remote control to select a preset number.
or
Turn the **DJ JOG** control left or right on the main unit to select the stored station.

Timer Function

Setting the Clock

For each step, you have a few seconds to set the required options. If you exceed this time, you must start again.

- Press the **TIMER SET** button on the remote control twice. "CLOCK SET" is displayed.
- Press the \square button on the remote control. The hour flashes.
 - To increase the hours: **TUNING/ALBUM** \blacktriangle
 - To decrease the hours: **TUNING/ALBUM** \blacktriangledown
- When the correct hour is displayed, press the \square button, and then the minutes flash.
 - To increase the minutes: **TUNING/ALBUM** \blacktriangle
 - To decrease the minutes: **TUNING/ALBUM** \blacktriangledown
- When the correct minute is displayed, press the \square button. "TIMER PLAY SET" appears in the display.

























Setting the Timer

The timer enables you to set the product to switch on or off at specific times automatically.











- Before setting the timer, check that the current time is correct.
- For each step, you have a few seconds to set the required options. If you exceed this time, you must start again.
- If you no longer want the product to be switched on or off automatically, you must cancel the timer by pressing the **TIMER ON/OFF** button.



Example: You want to wake up to music every morning.

- Press the **TIMER SET** button until **TIMER PLAY SET** is displayed.

2. Press the  button.
Result: **ON TIME** is displayed for a few seconds. You can set the timer switch-on time.
3. Set the timer switch-on time.
 - a. Press the **TUNING/ALBUM**  or  button to set the hours.
 - b. Press the  button.
Result: The minutes flash.
 - c. Press the **TUNING/ALBUM**  or  button to set the minutes.
 - d. Press the  button.
Result: **OFF TIME** is displayed for a few seconds. You can now set the timer switch-off time.
4. Set the timer switch-off time.
 - a. Press the **TUNING/ALBUM**  or  button to set the hours.
 - b. Press the  button.
Result: The minutes flash.
 - c. Press the **TUNING/ALBUM**  or  button to set the minutes.
 - d. Press the  button.
Result: **VOLUME XX** is displayed, where **XX** corresponds to the volume already set.
5. Press the **TUNING/ALBUM**  or  button to adjust the volume level and press the  button.
Result: The source to be selected is displayed.
6. Press the **TUNING/ALBUM**  or  button to select the source the Hi-Fi Component will play when it switches on.
7. Press the  button.
Result: **TIMER REC SET** (Do you want to record?) is displayed.
8. Press the  button.
Result: **REC SET YES/NO** is displayed. You can press the **TUNING/ALBUM**  or  button to select **REC YES** or **REC NO**, and then press  button.
 - 1) If you select **REC NO**, it will cancel tuner timer recording and any currently set tuner timer recording. Note that selecting **REC NO** does not cancel the Timer setting.
 - 2) If you select **REC YES**, you can set the tuner timer recording on and off times.
 - a. Press the  button.
Result: **ON TIME** is displayed for a few seconds. You can set the tuner timer recording switch-on time.
 - b. Press the  button.
Result: **OFF TIME** is displayed for a few seconds. You can set the tuner timer recording switch-off time.

NOTES

-  Tuner timer recording On/Off times can differ from Timer On/Off times.
-  If the timer switch on and off times are identical, the word **ERROR** is displayed.
-  You can use the   buttons on the product instead of the **TUNING/ALBUM**  or  button to make adjustments in Steps 3 through 8.
-  If the switch-on or -off time is the same as the timer recording time, only the switch-on or -off time is effective, and the timer recording is not applied.
-  When you use the auto timer, you may need an additional step to use a CD or USB device with it, depending on the disc (or device). Consequently, it is easier to use the tuner instead.
-  If you select CD or USB mode when there is no disc or no USB in the product, it will automatically change to TUNER.

If you select	You must also
FM (radio)	<ol style="list-style-type: none"> a. Press the  button. b. Select a preset station by pressing the TUNING/ALBUM  or  button.
CD (compact disc)	Load a compact disc.
USB	Connect a USB device.

Functions

Canceling the Timer

After you have set the timer, it will start automatically. When it starts, the **TIMER ON** message appears on the display. If you no longer want to use the timer, you must cancel it.

- To cancel the timer, Press the **TIMER ON/OFF** button once.
- To restart the timer, Press the **TIMER ON/OFF** button once again.

NOTES

- ✎ When you select the **TIMER OFF** mode, the **TIMER RECORDING** and **TIME** function are not available.



The Recording Function

Basic Recording

You can record from a CD, a USB device, a radio broadcast, or an external source to a USB storage device.

1. Connect an external USB storage device to a USB ( **REC**) jack on your product. You can use USB 2.
2. Play a disc or USB, turn on the radio and select a station, or connect an external source to your product as described below.

CD

- Press the **CD** button on the product to select the CD function.
- Insert a CD gently into the disc slot.
- Use the CD selection ( or ) buttons to select the desired song.

TUNER

- Select FM by pressing the **TUNER/AUX** button.
- Select the radio frequency you want to record.

USB 1 (Recording device is on USB 2)

- Connect the USB device with the files you want to record to USB 1 jack.
- Press the **USB** button to select USB 1.
- Play a song from the USB 1.

External Source

- Connect an External device/MP3 player to the product.
 - Press the **TUNER/AUX** button to select **AUX IN 1** or **AUX IN 2**.
 - Play a song from the external device.
3. Press the **USB REC** button on the remote control to start recording.

CD

- CD recording starts and "TRACK RECORD" and the current track number appear on the display alternately.
- If you want to record all the tracks on the disc, press and hold the **USB REC** button. "FULL CD RECORD" is displayed.

RADIO

- "TUNER RECORD" is displayed and recording starts.

CD-ROM/USB

- "FILE COPY" is displayed and recording starts.
- You can also copy a folder containing MP3/WMA files to a device on USB 2. Press and hold the **USB REC** button while the system plays an MP3 or WMA file located in a folder. Your system displays "FOLDER COPY", and will record all the files in that folder.
- When the recording is done, "STOP" is displayed.
- If there is a file with the same name on the USB 2 device, "EXIST FILE" is displayed, and the function is canceled.

- If a microphone is connected to the product and you press the USB REC button, you activate the MP3 Recording function, not the Copy function.
- Press the USB REC button for a second to start FILE COPY. Press and hold the USB REC button for a few seconds to start FOLDER COPY.

External Source

- "AUX RECORD" is displayed and recording starts.

CD/USB1(MP3) & MIC

- "MP3 RECORD" is displayed and recording starts.
4. To stop recording, press the **□** button. The recording is automatically saved as an MP3 file.
 5. After the recording is finished, a directory named "RECORDING"(CD-DA), "COPY"(CD-ROM/ USB), "TUNER RECORDING", "AUX RECORDING" or "MP3 RECORDING" is created in your device.

| NOTES |

- 🔗 WMA/MP2 files can only be copied not recorded.
- 🔗 Do not disconnect the USB device or the AC Cord during recording. You can cause file damage.
- 🔗 If you disconnected the USB device during recording, the product will turn off and you will not be able to delete the file that has been recorded. If this occurs, connect the USB device to a PC, back up the USB data to the PC, and then reformat the USB device.
- 🔗 If the USB device does not have enough memory, "NOT ENOUGH MEMORY" will appear on the display.
- 🔗 The Recording function supports the FAT file systems only. The NTFS file system is not supported.

- 🔗 When you use the CD high speed search function, the CD recording function is unavailable.
- 🔗 With some USB devices, recording time may be longer.
- 🔗 In the Program mode, you can't use the recording function.
- 🔗 When the Recording function is active, the EQ and GIGA SOUND functions automatically turn off and are unavailable.
- 🔗 During a CD recording, the REPEAT function automatically turns off and is unavailable.
- 🔗 If you use the MIC function during a CD recording, the voice from the microphone will be recorded.
- 🔗 You can not record audio from the radio when searching for a station or if there are no frequencies available when the product is set to Tuner mode.
- 🔗 Note that setting the input level too loud when recording music from an external device through the AUX or USB channel may introduce noise into the recording. If this occurs, lower the external device's volume level.

Recording Speed

Each time you press the **REC SPEED** button on the remote control, the recording speed will change as follows:

RECORD SPEED x 1 → RECORD SPEED x 4

- When you record from the tuner or an external source, you cannot change the recording speed.
- If you select RECORD SPEED X 4, sound is not produced during the recording.
- If you connect the microphone, you have one recording speed mode available: RECORD SPEED X 1.
- During recording, if you disconnect the microphone, the recording will stop. If you reconnect the microphone, the recording will not restart.

















| NOTES |

- 🔗 Even when RECORD SPEED x4 is set, recording may not be made in x4 speed depending on the used USB storage device.

Special Sound Effects

Selecting EQ Mode

Your Hi-Fi Component system provides predefined equalizer settings that are optimized for particular music genre. You can also adjust the bass, middle, and treble levels manually.

1. Press the **EQ** button.
Each time you press the **EQ** button or turn the **VOLUME/SEARCH JOG** control on the product, the mode changes as follows:
OFF → FLAT → RANCHERA → CUMBIA → REGGAE → MERENGUE → SALSA → REGGATON → FOLKLORE → PARTY → POP → HIP-HOP → ROCK → JAZZ → CLASSIC → ELEC-TRONIC → MP3 ENHANCER → VIRTUAL SOUND → USER EQ
2. To set the **BASS**, **MID** (Middle), and **TREB** (Treble) levels manually, select **USER EQ**, and then press the  button.
Result: The **BASS** level (left numeric) flashes.
Press the  or  button on the product or **TUNING/ALBUM**  ,  button to select a level from -06 to 06.
Then, press the  button.
Result: The **MIDDLE** level (middle numeric) flashes.
Press the  or  button on the product or **TUNING/ALBUM**  ,  button to select a level from -06 to 06.
Then, press the  button.
Result: The **TREBLE** level (right numeric) flashes.
Press the  or  button on the product or **TUNING/ALBUM**  ,  button to select a level from -06 to 06.
Then, press the  button.
Result: Setting is complete.

NOTES

- 1. When the Hi-Fi Component is recording, the EQ function is turned off automatically and is unavailable.
- 2. If no buttons are pressed within 8 seconds, your settings will automatically be cancelled and the previous settings will be saved.
- 3. The EQ mode may be different depending on your region.
- 4. Use the **VOLUME/SEARCH JOG** to alter the EQ mode, and the selected EQ mode will be applied after 2 seconds.
- 5. Use the **VOLUME/SEARCH JOG** to alter the EQ mode and press  . EQ screen disappears.

FOOTBALL MODE function

The football mode brings greater realism to sports broadcasts.

1. Press the **FOOTBALL MODE** button on the product.
Each time you press this button, the mode changes as follows:
OFF → ANNOUNCER → STADIUM
2. To cancel this function, press the **FOOTBALL MODE** button until "OFF" is displayed.

GOAL Function

Press this button to add the sound of cheering while watching a football game.

1. Press the **GOAL** button on the remote control.
Each time you press this button, the mode changes as follows:
GOAL ON → GOAL OFF
2. To cancel this function, press the **GOAL** button until "GOAL OFF" is displayed.

I NOTES I

- Press the **GOAL** button to output the currently playing sound file mixed with the **GOAL sound**.

GIGA SOUND Function

The GIGA SOUND function amplifies the bass sound and provides twice the bass for powerful, realistic sound.

- Press the **GIGA SOUND BEAT** button on the main unit or the **GIGA** button on the remote control. Each time you press this button, the mode changes as follows:

GIGA SOUND BEAT → GIGA SOUND OFF

- To cancel this function, press the **GIGA SOUND BEAT** button until "GIGA SOUND OFF" is displayed.

I NOTES I

- The GIGA SOUND mode may be different depending on your region.

BEAT WAVING Function

The Beat Waving function lets you change the Speaker LED display mode.

- Press the **BEAT WAVING** button on the product or on the remote control. Each time you press this button, the mode changes as follows:

STARDUST → EMERALD MOON → SOLAR BOMB → SHOOTING STAR → STAR → PARTY 1 → PARTY 2 → PARTY 3 → PARTY 4 → FUN 1 → FUN 2 → PURE → FRESH 1 → FRESH 2 → LOVE 1 → LOVE 2 → JOY 1 → JOY 2 → SUNSET → SUNRISE → NATURE 1 → NATURE 2 → WAVE 1 → WAVE 2 → AURORA → OFF

I NOTES I

- If you select **BEAT WAVING OFF**, all the speaker LED displays are turned off.

DJ BEAT Function

The DJ Beat function lets you turn on the DJ Beat sound effect functions. The level of each effect is adjustable.

Press the **DJ BEAT** button on the remote control or on the product.

Each time you press this button, the mode changes as follows:

I IMPORTANT I

- You can set each of the DJ Beat functions from -15 to +15. The initial setting for all functions is 0.
- FLANGER** : Creates an effect similar to the sound of a jet engine revving up and down.
- CHORUS** : Creates an effect similar to a singing chorus.
- WAHWAH** : Creates a 'Wah~ Wah~' effect.
- TREMOLO** : Repeatedly and rapidly turns the volume up and down.
- FUZZ** : Distorts the original sound to make it harder and harsher.
- PHASER** : Alters the original sound from clear to dull.
- SLAPBACK** : Creates the effect of a slapback echo following the original sound.
- DJ BEAT OFF** : Turns off this function.

I NOTES I

- The red LED turns on around the button you pushed and around the **DJ BEAT** button.
- You can control the intensity of the effect with the DJ Jog.
- To cancel an effect, press the effect's button again.
- You can also control the effect using the **EFFECT LEVEL** button on the remote control.
- Use the DJ Jog to control the intensity of the effect that was activated last. For example, if you activated the WahWah effect and then the Panning effect, the DJ Jog will control the Panning effect.
- To control the intensity of the effect you applied first, press the button of effect that you applied last to turn it off. Then, you can use the DJ Jog to control the intensity of the first effect.

Functions

+PANNING Function

Increases the left and right speaker's output in turn and makes it seem as if the sound is moving from side to side.

I NOTES I

- To apply the **PANNING** effect to another effect, press the **+PANNING** button when the other effect is active or press another effect button when the **PANNING** effect is active.

NON-STOP MUSIC RELAY Function

The NON-STOP MUSIC RELAY function plays music continuously without an interval between tracks/files. If there were two mp3 files, it skips to the next file's 10 seconds from the start position when the previous track reaches its 10 seconds before the end position. Press the **NON-STOP MUSIC RELAY** button on the product or **NON-STOP RELAY** button on the remote control.

Each time you press this button, the mode changes as follows:

NON-STOP RELAY ON → NON-STOP RELAY OFF

I NOTES I

- This function is only available during playback of a CD/USB.

DANCE TIME Function

Press the **DANCE TIME** button on the remote control when playing music to play the dance music stored in the product.

Use this function to enjoy exciting music.

- Press the **DANCE TIME** button on the remote control or on the product. Each time you press this button, the mode changes as follows:

DANCE TIME ON → DANCE TIME OFF

- To cancel this function, press the **DANCE TIME** button until "DANCE TIME OFF" is displayed.

I NOTES I

- When the DANCE TIME sound file finishes playing, the DANCE TIME mode changes to DANCE TIME OFF.
- When DANCE TIME mode is switched **ON**, the B/T, TV SoundConnect, TUNER, and AUX sources enter Mute mode. The music that is currently playing is paused.
- When you turn off DANCE TIME, any CD or USB whose playback had been paused when you started DANCE TIME, resumes from the beginning of the track that had been playing.
- When playing a DANCE TIME sound file, you can change the dance music by pressing the **⏮**, **⏭** button.

TEMPO Function

Use this to change the TEMPO while music is playing.

- During playback (CDDA/ MP3/ WMA), press the **TEMPO** button on the remote control or on the product.
- Select the desired TEMPO by using the **EFFECT LEVEL** button on the remote control.

I NOTES I

- TEMPO Function does not operate in the Bluetooth, TV SoundConnect, FM and AUX mode.
- When you turn TEMPO off, all TEMPO settings are lost.

Troubleshooting

Refer to the chart below when this product does not function properly. If the problem you are experiencing is not listed below or if the instructions below do not help, turn off the product, disconnect the power cord, and contact the nearest authorized dealer or Samsung Electronics Service Center.

Symptom	Check/Remedy
I cannot eject the disc.	<ul style="list-style-type: none"> • Is the power cord plugged securely into the outlet? • Turn off the power and then turn it back on.
Playback does not start immediately when the Play/Pause button is pressed.	<ul style="list-style-type: none"> • Are you using a deformed disc or a disc with scratches on the surface? • Wipe the disc clean.
Sound is not produced.	<ul style="list-style-type: none"> • No sound is heard during fast playback, slow playback, and step motion playback. • Are the speakers connected properly? Is the speaker setup correctly customized? • Is the disc severely damaged?
The remote control does not work.	<ul style="list-style-type: none"> • Is the remote control being operated within its operational angle and distance range? • Are the batteries drained?
The product is not working. (Example: The power goes out or the front panel buttons don't work, or you hear a strange noise.) The product is not working normally.	<ul style="list-style-type: none"> • Press the ■ button (on front panel) for more than 5 seconds with no disc inside. The initialization message appears on the screen, and the power will turn off automatically. When you turn your product on again, all the settings will be reset. Don't use this unless absolutely necessary.
Can't receive radio broadcast.	<ul style="list-style-type: none"> • Is the antenna connected properly? • If the antenna's input signal is weak, install an external FM antenna in an area with good reception.

Appendix

Specifications

General	Power Requirements		AC110-120V ~ 50/60Hz
	Power Consumption		146W
	Weight	Main unit	17.6 lbs
		Speaker	144.6 lbs
	Dimensions	Main unit	23.2 (W) x 9.4 (H) x 15.3 (D) inches
		Speaker	23.2 (W) x 34.9 (H) x 21.6 (D) inches
	Operating Temperature Range		41°F~95°F (5°C~35°C)
Operating Humidity Range		10 % to 75 %	
FM Tuner	Signal/Noise ratio		55 dB
	Usable sensitivity		10 dB
	Total harmonic distortion		1 %
CD Disc	CD : 12 cm (COMPACT DISC)	Reading Speed : 4.8 ~ 5.6 m/sec. Maximum Play Time : 74 min.	
Amplifier	Front speaker output		850W/CH (4Ω)
	Subwoofer output		850W/CH (4Ω)
	Frequency range		22Hz~20KHz
	S/N Ratio		65 dB
	Channel separation		60 dB
	Input sensitivity		AUX IN1 1.2V, AUX IN2 2.0V

*: Nominal specification

- Samsung Electronics Co., Ltd reserves the right to change the specifications without notice.
- Weight and dimensions are approximate.
- Design and specifications are subject to change without prior notice.
- For information on the power supply and power consumption, refer to the label attached to the product.
- Dispose unwanted electronics through an approved recycler.
To find the nearest recycling location, go to our website: www.samsung.com/recyclingdirect or call, (877)278 - 0799

Open Source Announcement

To send inquiries and requests regarding open sources, contact Samsung via Email (oss.request@samsung.com).

LIMITED WARRANTY TO ORIGINAL PURCHASER

This SAMSUNG brand product, as supplied and distributed by Samsung Electronics America, Inc. (SAMSUNG) and delivered new, in the original carton to the original consumer purchaser, is warranted by SAMSUNG against manufacturing defects in materials and workmanship for a limited warranty period of:

One (1) Year Parts and Labor*
(*90 Days Parts and Labor for Commercial Use)

This limited warranty begins on the original date of purchase, and is valid only on products purchased and used in the United States. To receive warranty service, the purchaser must contact SAMSUNG for problem determination and service procedures. Warranty service can only be performed by a SAMSUNG authorized service center. The original dated bill of sale must be presented upon request as proof of purchase to SAMSUNG or SAMSUNG's authorized service center. Transportation of the product to and from the service center is the responsibility of the purchaser.

SAMSUNG will repair or replace this product, at our option and at no charge as stipulated herein, with new or reconditioned parts or products if found to be defective during the limited warranty period specified above. All replaced parts and products become the property of SAMSUNG and must be returned to SAMSUNG. Replacement parts and products assume the remaining original warranty, or ninety (90) days, whichever is longer.

SAMSUNG's obligations with respect to software products distributed by SAMSUNG under the SAMSUNG brand name are set forth in the applicable end user license agreement. Non-SAMSUNG hardware and software products, if provided, are on an "AS IS" basis.

Non-SAMSUNG manufacturers, suppliers, publishers, and service providers may provide their own warranties.

This limited warranty covers manufacturing defects in materials and workmanship encountered in normal, and except to the extent otherwise expressly provided for in this statement, noncommercial use of this product, and shall not apply to the following, including, but not limited to: damage which occurs in shipment; delivery and installation; applications and uses for which this product was not intended; altered product or serial numbers; cosmetic damage or exterior finish; accidents, abuse, neglect, fire, water, lightning or other acts of nature; use of products, equipment, systems, utilities, services, parts, supplies, accessories, applications, installations, repairs, external wiring or connectors not supplied and authorized by SAMSUNG, or which damage this product or result in service problems; incorrect electrical line voltage, fluctuations and surges; customer adjustments and failure to follow operating instructions, cleaning, maintenance and environmental instructions that are covered and prescribed in the instruction book; product removal or reinstallation; reception problems and distortion related to noise, echo, interference or other signal transmission and delivery problems. SAMSUNG does not warrant uninterrupted or error-free operation of the product.

THERE ARE NO EXPRESS WARRANTIES OTHER THAN THOSE LISTED AND DESCRIBED ABOVE, AND NO WARRANTIES WHETHER EXPRESS OR IMPLIED, INCLUDING, BUT NOT LIMITED TO, ANY IMPLIED WARRANTIES OF MERCHANTABILITY OR FITNESS FOR A PARTICULAR PURPOSE, SHALL APPLY AFTER THE EXPRESS WARRANTY PERIODS STATED ABOVE, AND NO OTHER EXPRESS WARRANTY OR GUARANTY GIVEN BY ANY PERSON, FIRM OR CORPORATION WITH RESPECT TO THIS PRODUCT SHALL BE BINDING ON SAMSUNG. SAMSUNG SHALL NOT BE LIABLE FOR LOSS OF REVENUE OR PROFITS, FAILURE TO REALIZE SAVINGS OR OTHER BENEFITS, OR ANY OTHER SPECIAL, INCIDENTAL OR CONSEQUENTIAL DAMAGES CAUSED BY THE USE, MISUSE OR INABILITY TO USE THIS PRODUCT, REGARDLESS OF THE LEGAL THEORY ON WHICH THE CLAIM IS BASED, AND EVEN IF SAMSUNG HAS BEEN ADVISED OF THE POSSIBILITY OF SUCH DAMAGES. NOR SHALL RECOVERY OF ANY KIND AGAINST SAMSUNG BE GREATER IN AMOUNT THAN THE PURCHASE PRICE OF THE PRODUCT SOLD BY SAMSUNG AND CAUSING THE ALLEGED DAMAGE. WITHOUT LIMITING THE FOREGOING, PURCHASER ASSUMES ALL RISK AND LIABILITY FOR LOSS, DAMAGE OR INJURY TO PURCHASER AND PURCHASER'S PROPERTY AND TO OTHERS AND THEIR PROPERTY ARISING OUT OF THE USE, MISUSE OR INABILITY TO USE THIS PRODUCT SOLD BY SAMSUNG NOT CAUSED DIRECTLY BY THE NEGLIGENCE OF SAMSUNG. THIS LIMITED WARRANTY SHALL NOT EXTEND TO ANYONE OTHER THAN THE ORIGINAL PURCHASER OF THIS PRODUCT, IS NONTRANSFERABLE AND STATES YOUR EXCLUSIVE REMEDY.

Some states do not allow limitations on how long an implied warranty lasts, or the exclusion or limitation of incidental or consequential damages, so the above limitations or exclusions may not apply to you. This warranty gives you specific legal rights, and you may also have other rights which vary from state to state.

To obtain warranty hardware service, please contact SAMSUNG customer care center.

The benefits of this Limited Warranty extend only to the original purchaser of Samsung products from an authorized Samsung reseller. THIS LIMITED WARRANTY SHALL NOT APPLY TO ANY SAMSUNG PRODUCTS PURCHASED FROM UNAUTHORIZED RESELLERS OR RETAILERS, EXCEPT IN STATES WHERE SUCH RESTRICTION MAY BE PROHIBITED. For a list of Samsung authorized retailers, please go to: http://www.samsung.com/us/peaceofmind/authorized_resellers.html.



QUESTIONS OR COMMENTS?

Area	CALL	OR VISIT US ONLINE AT	WRITE
IN THE US	1-800-SAMSUNG (726-7864)	www.samsung.com/us/ support	Samsung Electronics America, Inc. 85 Challenger Road Ridgefield Park, NJ 07660

© 2014 Samsung Electronics Co., Ltd. All rights reserved.



AH68-02687A-05



AH68-02687A-05

Free Manuals Download Website

<http://myh66.com>

<http://usermanuals.us>

<http://www.somanuals.com>

<http://www.4manuals.cc>

<http://www.manual-lib.com>

<http://www.404manual.com>

<http://www.luxmanual.com>

<http://aubethermostatmanual.com>

Golf course search by state

<http://golfingnear.com>

Email search by domain

<http://emailbydomain.com>

Auto manuals search

<http://auto.somanuals.com>

TV manuals search

<http://tv.somanuals.com>