

SAMSUNG

**THREE-CD CHANGER
MINI-COMPACT SYSTEM
MP3-CD/CD-R/RW PLAYBACK
MAX-ZL65**

Instruction Manual



Safety Warnings

GB

CLASS 1 LASER PRODUCT
KLASSE 1 LASER PRODUKT
LUOKAN 1 LASER LAITE
KLASS 1 LASER APPARAT
PRODUCTO LASER CLASE 1

Use of controls, adjustments or performance of procedures other than those specified herein may result in hazardous radiation exposure.

CAUTION-INVISIBLE LASER RADIATION WHEN OPEN AND INTERLOCKS DEFEATED, AVOID EXPOSURE TO BEAM.

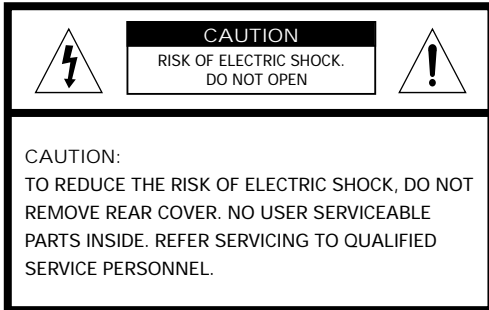

This symbol indicates that dangerous voltage which can cause electric shock is present inside this unit.



This symbol alerts you to important operating and maintenance instructions accompanying the unit.

WARNING: To reduce the risk of fire or electric shock, do not expose this appliance to rain or moisture.

CLASS 1 LASER PRODUCT

This Compact Disc player is classified as a CLASS 1 LASER product.

CAUTION: TO PREVENT ELECTRIC SHOCK, MATCH WIDE BLADE OF PLUG TO WIDE SLOT, FULLY INSERT.

Wiring the Main Power Supply Plug(UK Only)

IMPORTANT NOTICE

The main lead on this equipment is supplied with a moulded plug incorporating a fuse. The value of the fuse is indicated on the pin face of the plug and if it requires replacing, a fuse approved to BS1362 of the same rating must be used.

Never use the plug with the fuse cover removed. If the cover is detachable and a replacement is required, it must be of the same colour as the fuse fitted in the plug. Replacement covers are available from your dealer.

If the fitted plug is not suitable for the power points in your house or the cable is not long enough to reach a power point, you should obtain a suitable safety approved extension lead or consult your dealer for assistance.

However, if there is no alternative to cutting off the plug, remove the fuse and then safely dispose of the plug. Do not connect the plug to a main socket as there is a risk of shock hazard from the bared flexible cord.

Never attempt to insert bare wires directly into a main socket. A plug and fuse must be used at all times.

IMPORTANT

The wires in the main lead are coloured in accordance with the following code:--

BLUE = NEUTRAL BROWN = LIVE

As these colours may not correspond to the coloured markings identifying the terminals in your plug, proceed as follows:--

The wire coloured BLUE must be connected to the terminal marked with the letter N or coloured BLUE or BLACK.

The wire coloured BROWN must be connected to the terminal marked with the letter L or coloured BROWN or RED.

WARNING: DO NOT CONNECT EITHER WIRE TO THE EARTH TERMINAL WHICH IS MARKED WITH THE LETTER E OR BY THE EARTH SYMBOL , OR COLOURED GREEN OR GREEN AND YELLOW.

Contents

Thank you for buying this
SAMSUNG mini-compact system.

Please take time to read these instructions.
They will allow you to operate your
system with ease and take full advantage
of its features.

GB

◆ SAFETY WARNINGS	2
◆ INSTALLING YOUR MINI-COMPACT SYSTEM	
■ Front Panel View	4
■ Remote Control	5
■ Rear Panel View	6
■ Where to Install Your Mini-Compact System	7
■ Connecting your System to the Power Supply	7
■ Inserting Remote Control Batteries	7
■ Connecting to an External Source	8
■ CD Digital Out Jack	8
■ Connecting the Loudspeakers	8
■ Connecting the AM (MW)/LW Aerial	9
■ Connecting the FM Aerial	9
■ Viewing the Various Functions on Your System	10
■ Setting the Clock	10
◆ CD-PLAYER	
■ Loading and Changing Compact Discs	11
■ To replay the CD/MP3-CD	11
■ Selecting a CD in the Disc changer	12
■ Selecting a Track	12
■ To select the MP3-CD title and track	12
■ Searching for a Specific Music Passage on a CD	13
■ Function to skip through 10 tracks at a time	13
■ Last Memory Function	13
■ Shuffle Play Function	14
■ Repeating One or All Tracks on the Compact Discs	14
■ Programming the Order of Playback	14
■ Checking or Changing Programmed Tracks	15
◆ TUNER	
■ Searching for and Storing the Radio Stations	15
■ Selecting a Stored Station	16
■ Improving Radio Reception	16
■ About RDS broadcasting	17
■ About RDS DISPLAY function	17
■ PTY (Program Type) indication and PTY-SEARCH function	18
◆ TAPE DECK	
■ Listening to a Cassette	19
■ CD Synchro Record Feature	19
■ Recording a Compact Disc	19
■ Recording a Radio Program	20
■ Copying a Cassette (Dubbing)	20
■ Selecting the Cassette Playback Mode (Deck 2 Only)	20
◆ OTHER FUNCTIONS	
■ Timer Function	21
■ Cancelling the Timer	21
■ Mute Function	22
■ Selecting an Equalizer Preset	22
■ Power Sound/Surround Function	22
■ D.S.P Function	22
■ Setting the System to Switch off Automatically	23
■ Super Bass Sound	23
■ Connecting Headphones	23
◆ RECOMMENDATIONS FOR USE	
■ Safety Precautions	24
■ Cleaning Your Mini-Compact System	24
■ Precautions When Using Compact Discs	25
■ Precautions When Using Audio Cassettes	25
■ Before Contacting the After-Sales Service	25
■ Technical Specifications	26

Symbols



Press



Push



Important



Note

Front Panel View

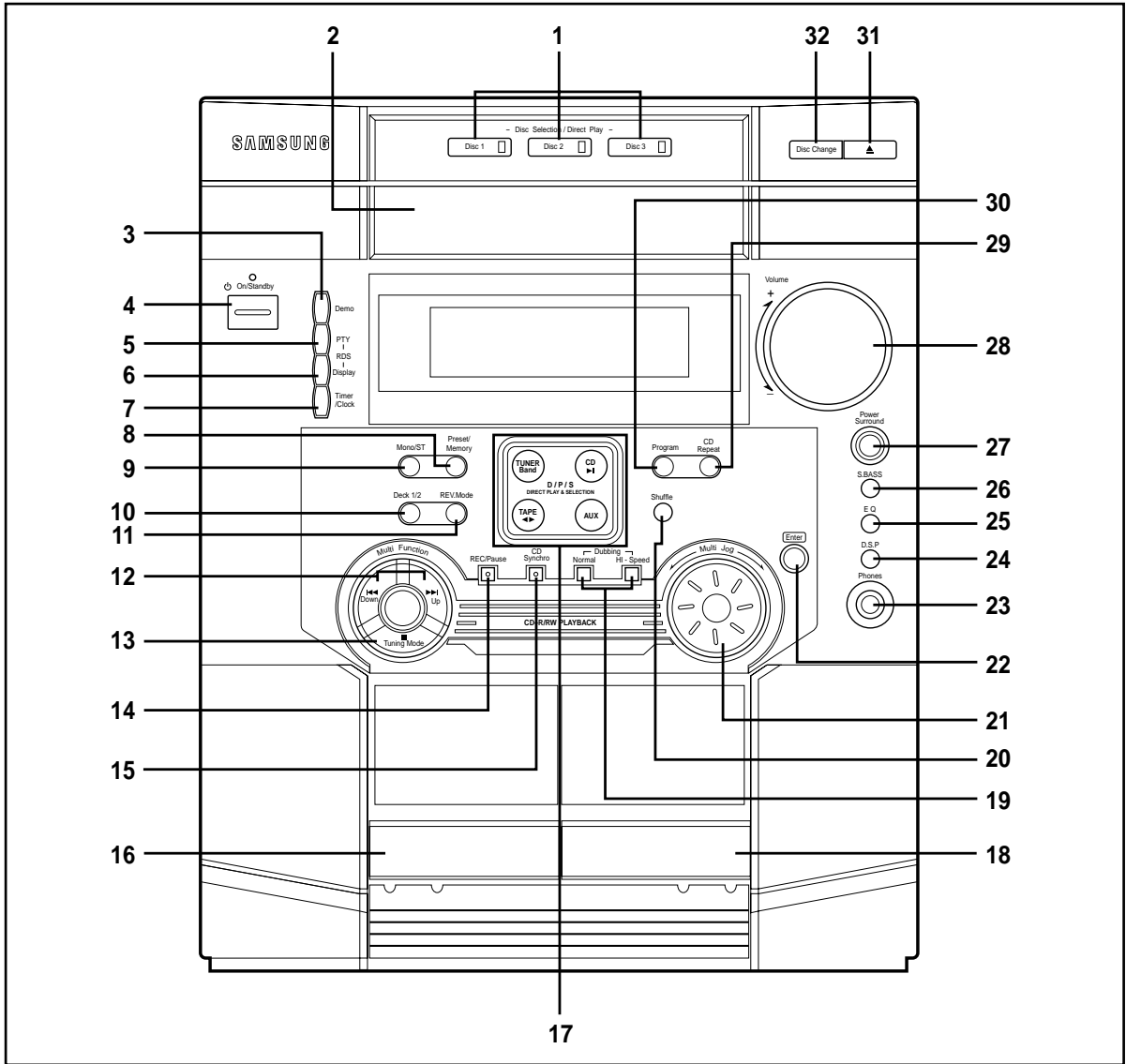

- | | |
|--------------------------------|------------------------------------|
| 1. Disc Selection buttons | 17. Function Selection buttons |
| 2. Compact Disc Compartment | 18. Cassette Deck 2 |
| 3. Demo | 19. TAPE Normal / Hi-Speed Dubbing |
| 4. On/Standby | 20. Shuffle |
| 5. PTY (RDS) | 21. Multi Jog |
| 6. Display (RDS) | 22. Enter |
| 7. Timer/Clock | 23. Headphone Jack Connector |
| 8. Preset/Memory | 24. D.S.P |
| 9. Mono/ST | 25. EQ |
| 10. Deck 1/2 | 26. S.BASS |
| 11. REV.Mode | 27. Power Surround |
| 12. Search Function buttons | 28. Volume |
| 13. Tuning Mode or Stop button | 29. CD Repeat |
| 14. REC/Pause | 30. Program |
| 15. CD Synchro Recording | 31. Open/Close |
| 16. Cassette Deck 1 | 32. Disc Change |

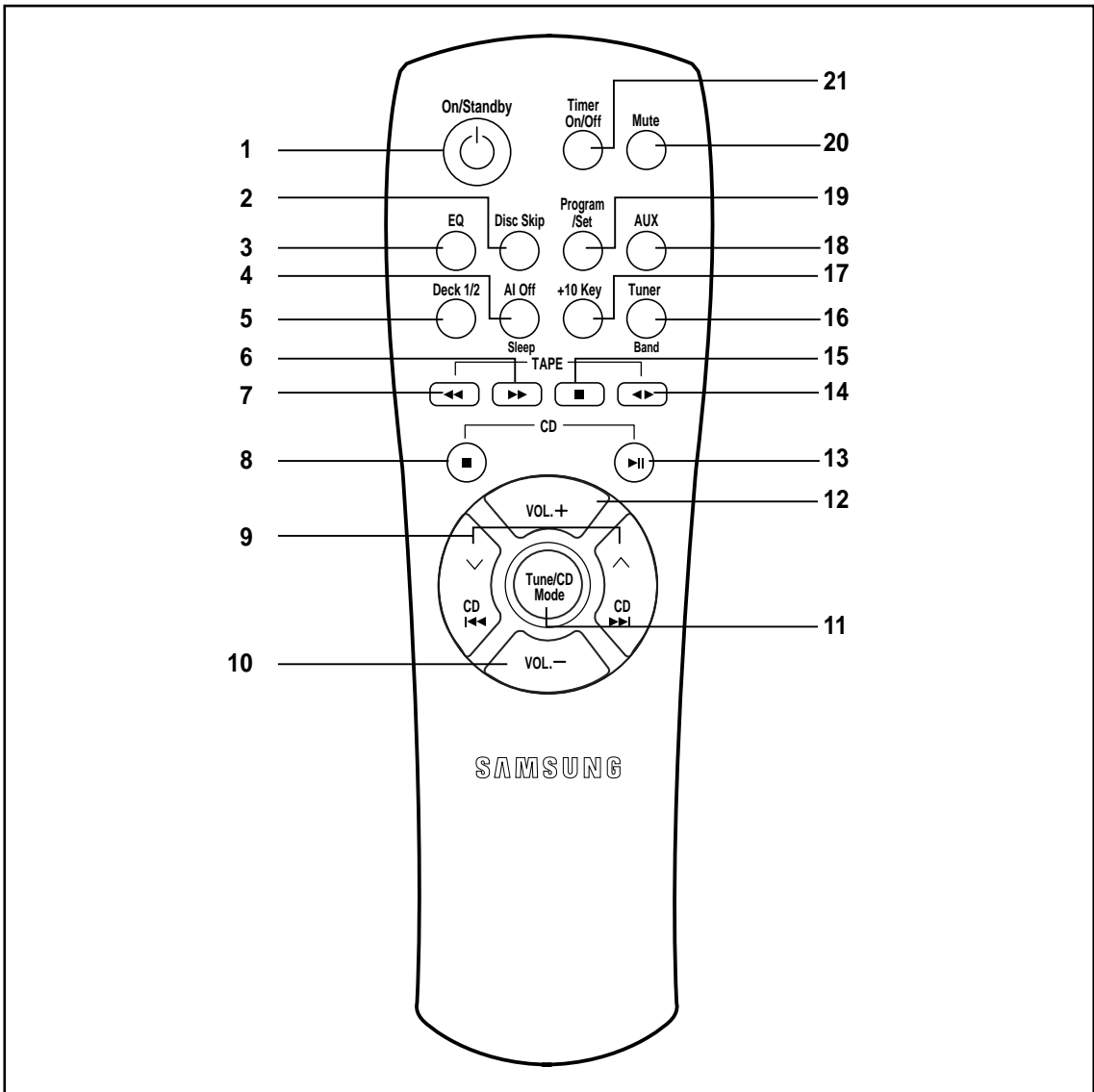

- | | |
|-------------------------------------|---------------------|
| 1. On/Standby | 12. Volume Increase |
| 2. Disc Number Skip | 13. CD Play/Pause |
| 3. EQ | 14. TAPE Play |
| 4. AI off/Sleep | 15. TAPE Stop |
| 5. Deck 1/2 | 16. Tuner Band |
| 6. TAPE Fast-Forward | 17. +10 Key |
| 7. TAPE Rewind | 18. AUX |
| 8. CD Stop | 19. Program/Set |
| 9. CD Track or Radio Station Search | 20. Mute |
| 10. Volume Decrease | 21. Timer On/Off |
| 11. Tune/CD Mode | |

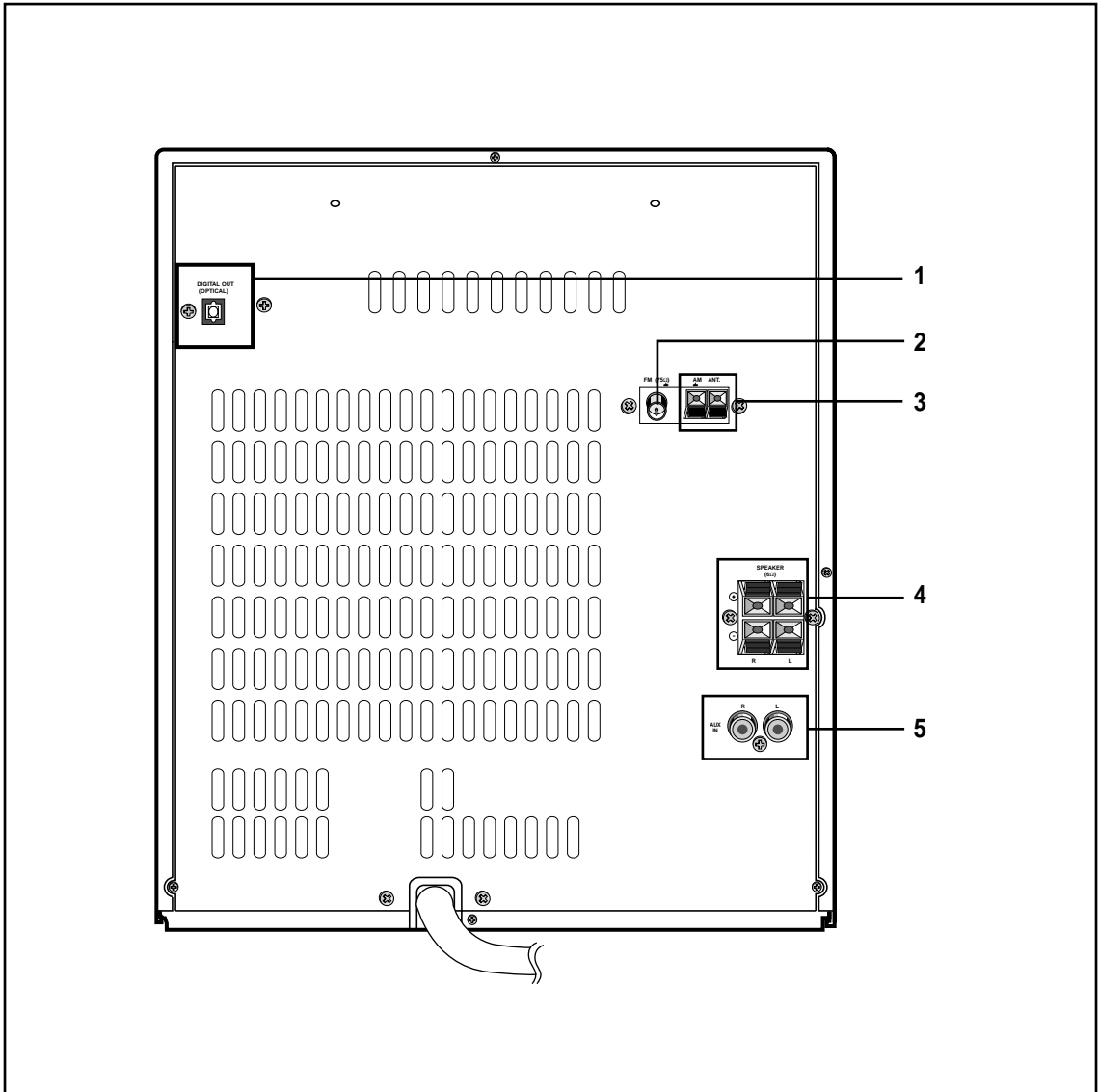

1. CD Digital out Jack
2. FM Aerial Connector Terminal
3. AM Aerial Connector Terminal
4. Loudspeaker Connector Terminals
5. AUX-Input

Where to Install Your Mini-Compact System

To take full advantage of your new mini-compact system, follow these installation instructions before connecting the unit.

- ◆ Install the system on a flat, stable surface.
- ◆ Never place this unit on carpeting.
- ◆ Never place this unit in an outdoor area.
- ◆ Maintain an open space of approximately 6 inches (15 cm) on the sides and rear of the system, for ventilation purposes.
- ◆ Make sure that you have enough room to open the compact disc compartment easily.
- ◆ Place the loudspeakers at a reasonable distance on either side of the system to ensure good stereo sound.
- ◆ Direct the loudspeakers towards the listening area.
- ◆ For optimum performance, make sure that both speakers are placed at an equal distance above the floor.

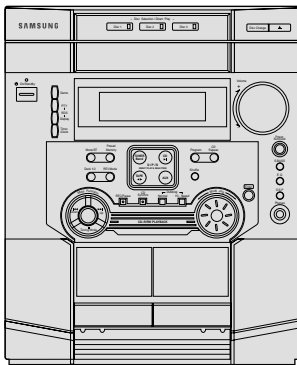

Connecting your System to the Power Supply

The main lead must be plugged into an appropriate socket.

- ☛ Before plugging your system into a main socket, you must check the voltage.

- 1 Plug the main lead (marked **AC Cord** on the rear of the system) into an appropriate socket.
- 2 Press the **On/Standby** button to switch your mini-compact system on.

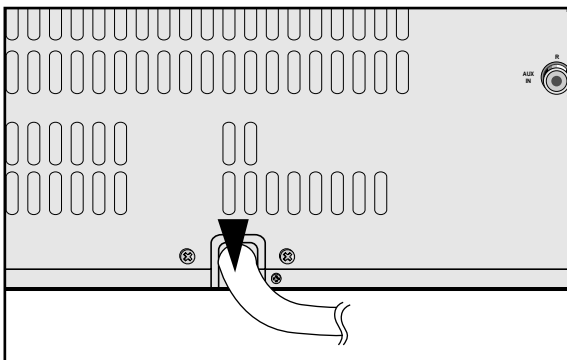

Inserting Remote Control Batteries

GB

Insert or replace remote control batteries when you:

- ◆ Purchase the mini-compact system
- ◆ Find that the remote control is no longer operating correctly

- ☛ When replacing the batteries, use a new set of batteries and never mix alkaline and manganese batteries.

- 1 Place your thumb on the position marked ☛ on the battery compartment cover (rear of the remote control) and push the cover in the direction of the arrow.
- 2 Insert two AAA, LR03 or equivalent batteries, taking care to respect the polarities:
 - ◆ + on the battery against + in the battery compartment
 - ◆ - on the battery against - in the battery compartment
- 3 Replace the cover by sliding it back until it clicks into position.

- ☛ If you will not be using the remote control for a long time, remove the batteries to prevent corrosion.

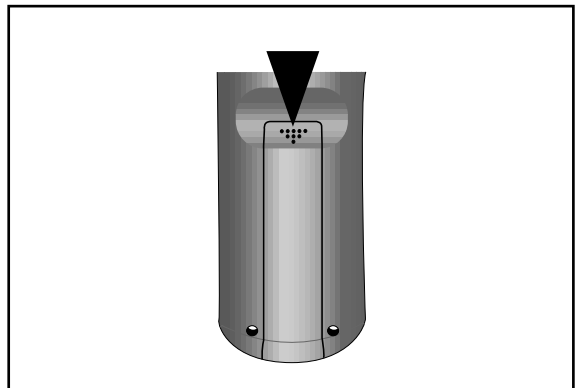

Connecting to an External Source

The auxiliary input can be used to take advantage of the sound quality of your mini-compact system when listening to other sources.

- Examples:**
- ◆ A television
 - ◆ A video disc player
 - ◆ A Hi-Fi stereo video cassette recorder

➤ To connect the external source, the source must have an audio output. In addition, you need an RCA connection cable.

- 1 Set the system to standby mode and disconnect it and the external source from the main.
- 2 Connect the audio cable to the rear of the mini-compact system.

Connect the...	To the connector marked...
Red jack	R (right)
White jack	L (left)

➤ For optimum sound quality, do not invert the right and left channels.
- 3 Plug the system back into the main socket and press **On/Standby** to switch it on.
- 4 Select the **AUX** source by pressing **AUX**.
Result: **AUX** is displayed.
- 5 Switch the external source on.
- 6 Adjust the volume and balance as required:
 - ◆ Volume
 - ◆ Equalizer

Example: You can watch a film and take advantage of stereo sound provided that the original sound track is in stereo (as if you were in a cinema).

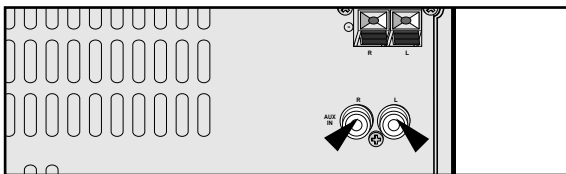

Connecting the Loudspeakers

The loudspeaker connector terminals are located on the rear of the system.

There are four terminals on the system:

- ◆ Two for the left speaker (marked L)
- ◆ Two for the right speaker (marked R)

To achieve the correct sound quality, connect the:

- ◆ Red wire to the + terminals
- ◆ Black wire to the - terminals

- 1 To connect a wire to a terminal, push the tab as far as it will go:
 - ◆ To the right on the system
- 2 Insert the wire, up to the plastic sheathing, in the hole.
- 3 Push the tab back:
 - ◆ To the left on the system, until it clicks into place
 - ◆ To the top on the loudspeaker**Result:** The wire is pinched and held firmly in place.
- 4 Repeat the operation for each wire.

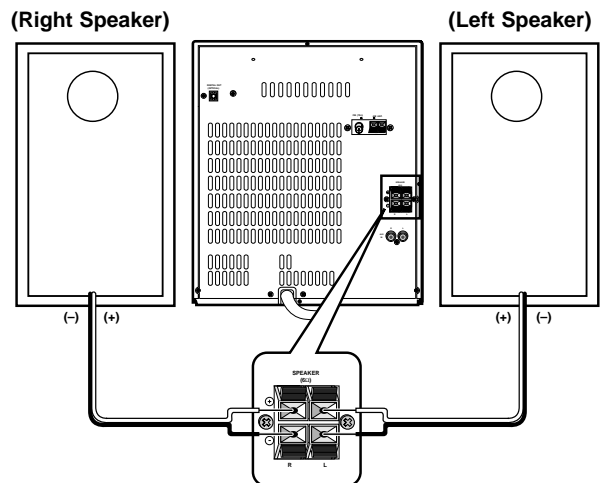

CD Digital Out Jack

This unit can output CD digital sound signals through this jack. Use an optical cable to connect digital audio equipment. (DAT deck, MD recorder, etc.). Remove the dust cap (1) from the CD DIGITAL OUT jack. Then, connect an optical cable plug to the CD DIGITAL OUT jack.

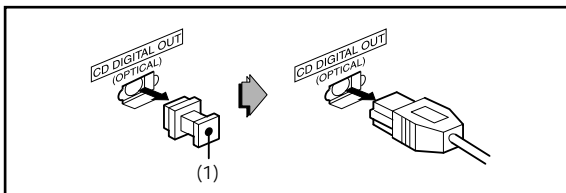

When the CD DIGITAL OUT jack is not being used Attach the supplied dust cap.

Directions in Installing Speaker

- ◆ Installation in a place near heating apparatus, under direct lay of light or with high humidity may cause performance degradation of the speaker.
- ◆ Do not install on the wall or on a high place of pole or other unstable place to prevent any safety accident caused by falling of the speaker.
- ◆ Do not take the speaker apart from TV or computer monitor. The speaker near the TV or computer monitor may influence the quality of the screen display.

Connecting the AM (MW)/LW Aerial

The AM aerial (for long and medium waves) can be:

- ◆ Placed on a stable surface
- ◆ Fixed to the wall (you must first remove the base)

The **AM** aerial connector terminals are located on the rear of the system and are marked **AM**.

- 🔊 To avoid noise interference, check that the loudspeaker wires do not run close to the aerial wires. Always keep them at least 2 inches (5 cm) away.

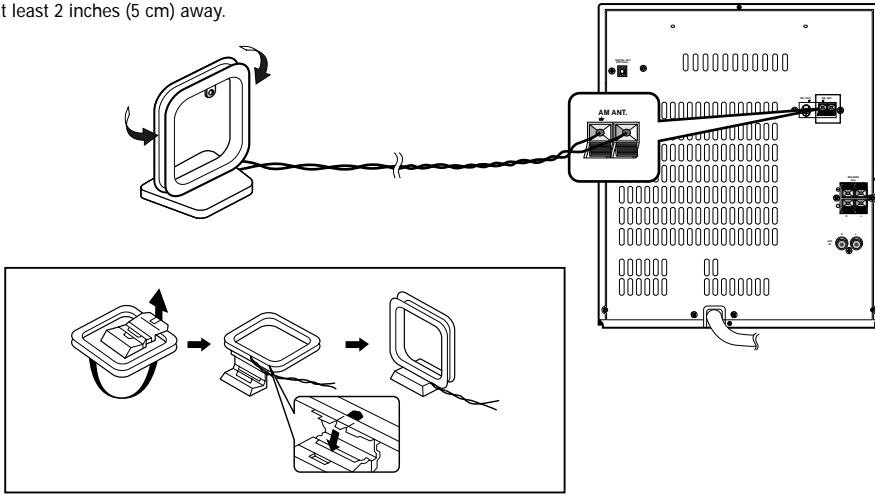

Connecting the FM Aerial

How to connect a COAXIAL TYPE aerial.

- ◆ Connect a 75Ω antenna to the **FM** antenna terminal.
- ◆ Plug the connector on the **FM** aerial supplied into the coaxial socket (75Ω) marked **FM** on the rear of the system.
- ◆ Follow the instructions given on Page 15 to tune into a radio station, and determine the best position for the aerial.
- ◆ If reception is poor, you may need to install an outdoor aerial. To do so, connect an outdoor **FM** aerial to the **FM** socket on the rear of the system using a 75Ω coaxial cable (not supplied).

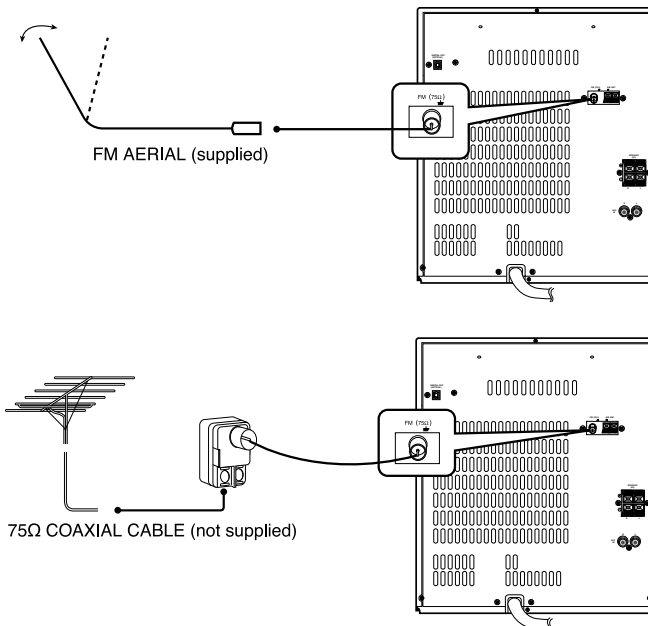

Viewing the Various Functions on Your System

GB

You can view the various functions available on your system.

- 1 Press the **Demo** button.
Result: The various functions available are listed in turn on the display.
- All these functions are described in detail in this booklet. For instructions on how to use them, refer to the appropriate sections.
- 2 To cancel this function, press **Demo** again.

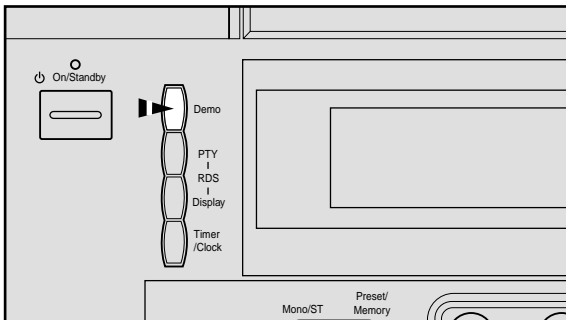

Setting the Clock

Your system is equipped with a clock which allows you to turn your system on and off automatically.

You should set the clock:

- ◆ When you first purchase the mini-compact system
 - ◆ After a power failure
 - ◆ After unplugging the unit
- ☛ ◆ For each step, you have a few seconds to set the required options. If you exceed this time, you must start again.

- 1 Switch the system on by pressing **On/Standby**.
- 2 Press **Timer/Clock** twice.
Result: **CLOCK** is displayed.
- 3 Press **Enter**.
Result: The hour flashes.
- 4 **To... Turn the Multi Jog knob to the...**
Increase the hours Right
Decrease the hours Left
- 5 When the correct hour is displayed, press **Enter**.
Result: The minutes flash.
- 6 **To... Turn the Multi Jog knob to the...**
Increase the minutes Right
Decrease the minutes Left
- 7 When the correct time is displayed, press **Enter**.
Result: The clock starts and is displayed, even when the system is in standby mode.

- ◆ You can display the time, even when you are using another function, by pressing **Timer/Clock** once.
- ◆ You can also use **Program/Set** button on the remote control to instead **Enter** button in step 3, 5, 7.
- ◆ You can also use **◀▶** buttons to instead **Multi Jog** knob in step 4, 6.

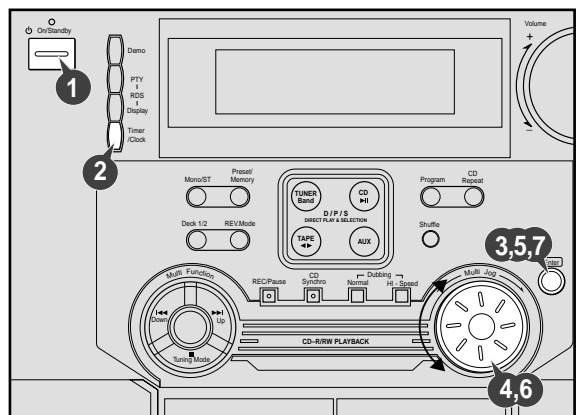

Loading and Changing Compact Discs

The CD disc changer can contain up to three 12 cm or 8 cm compact discs without using an adapter.

- ⚠ Never force the compact disc carousel when opening and closing the compartment.
Never press down or place objects on the carousel.
- Always treat your compact discs with care; refer, if necessary, to the section entitled "Precautions When Using Compact Discs" on page 25.

- 1 Switch the system on by pressing **On/Standby**.
- 2 Press the **Open/Close** (▲) button on the front panel.
Result: The compartment opens.
- 3 Place one or two discs in the front slots of the carousel, with the label on the discs facing upwards.
 - ⚠ Check that the compact disc has been correctly inserted in the holder before closing the compartment.
- 4 If you wish to load a third compact disc, press the **Disc Change** button on the front panel (or **Disc Skip** on the remote control).
Result: The carousel rotates by 120°.
- 5 Close the compartment by pressing the **Open/Close** (▲) button again.
 - If you wish to start playing a disc directly, you can also proceed as follows.

To play...	Press...
Disc 1	CD (▶) or DISC 1
Disc 2	DISC 2
Disc 3	DISC 3

Result: The compartment closes automatically and the disc selected starts playing.

- 6 To change or unload the compact disc changer, repeat Steps 2 to 5.

- ⚠ Keep the compartment closed whenever you are not using it, to prevent dust from entering.
- You can load or unload compact discs when the radio, tape or auxiliary source function is selected.

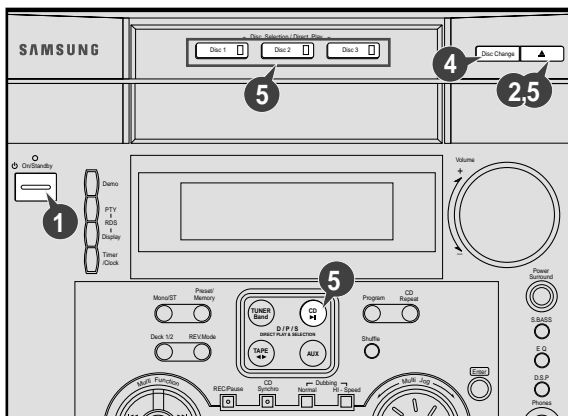

To replay the CD/MP3-CD

This is a player that enables the playback of audio CD, CD-R, CD-RW and MP3-CD and does not possess the function that saves MP3 files.

- ⚠ Do not use CDs of irregular shapes like heart or octagon shapes. The performance of the player may be degraded.
- At least more than one CD should be inserted for playbacks.

- 1 Press the **On/Standby** button to switch on the power.
- 2 Press the **CD** (▶||) of the main unit to select the CD function.
- 3 Insert more than one CD or a MP3-CD.
- 4 Press the **CD** (▶||) button of the main unit or the ▶|| button of the remote control.
 - If there is more than one CD or an MP3-CD inserted, replays are then processed in order.
 - Your CD Player will take a few moments to scan through all the tracks recorded on a particular MP3-CD.
 - The English name of the song may be indicated on the display only if directly downloaded from the PC or if the purchased MP3-CD is sorted according to titles(directory). (Other languages besides English may not be indicated.)
 - The English name of the track may not be indicated depending on the characteristics of the MP3-CD.

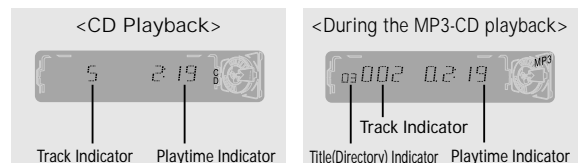

- 5 Adjust the volume according to needs with the following procedures.
 - Turn the Volume control of the main unit.
 - or
 - Press the VOL. + or - button of the remote control.
- 6 If it is desired to stop while the playback is processing, press the **CD** (▶||) button.
 - Press the **CD** (▶||) button once again to playback again.
- 7 To stop playback, press the ■ button.

- A new disc may be inserted in the remaining two compartments excluding the CD which is being played back. Press the Disc Changer button to open the CD tray. The revolving part does not turn during playbacks.
- If there is not even one CD inserted in the CD tray, it is indicated as "NO DISC".
- If the CD Repeat function is not selected, 3 CDs are played back which automatically stops.

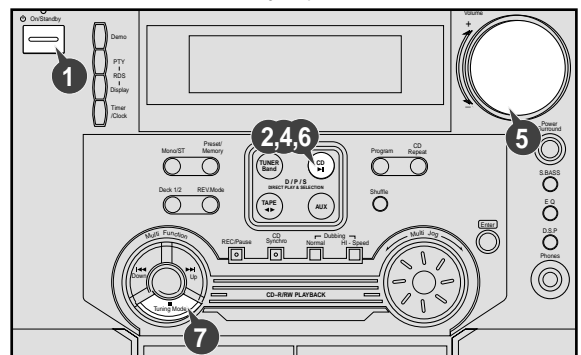

Selecting a CD in the Disc changer

The CD function is automatically selected when Disc Skip is pushed.

To select a specific disc, press the corresponding Disc (1, 2, 3) button on the front panel or Disc Skip on the remote control, until the required disc indicator flashes.

Result: All the discs will be played in turn, starting with the one selected.

- If you wish to play the current disc only, press CD Repeat on the front panel one or more times, until **1 CD** is displayed.
- ♦ If you use the Disc (1, 2, 3) function when listening to the radio or to a tape, the system switches automatically to the CD mode.
- ♦ If the disc selected is not loaded, the next disc is played automatically.

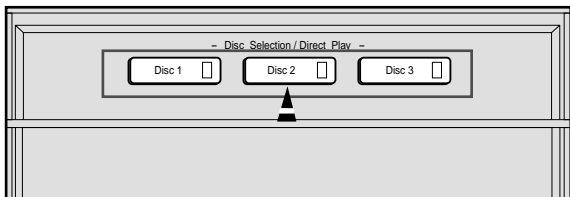

Selecting a Track

You can select the track you wish to listen to, either when the compact disc player is stopped or when a disc is playing.

To start playback at the beginning of the... Turn the Multi Jog knob...

Next track	One notch to the right
Current track	One notch to the left
Previous track	Two notches to the left
Track of your choice	The appropriate number of notches to the right or to the left

- ♦ You can also use the **⏮** and **⏭** buttons on the front panel, or the **⏮** and **⏭** buttons on the remote control to select a track.

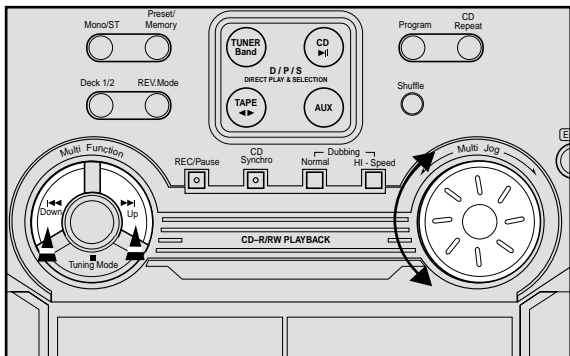

To select the MP3-CD title and track

The title and track of the MP3-CD desired to listen may be selected on stopping or during playbacks.

Main Unit

To move the title(directory), turn the **Multi-Jog** to the left and right.



To move the track, press the **⏮**, **⏭** button.

- ♦ Moves the track within the title.
- ♦ If the **⏮**, **⏭** button is pressed more than the number of tracks within the title, it moves to the next title.

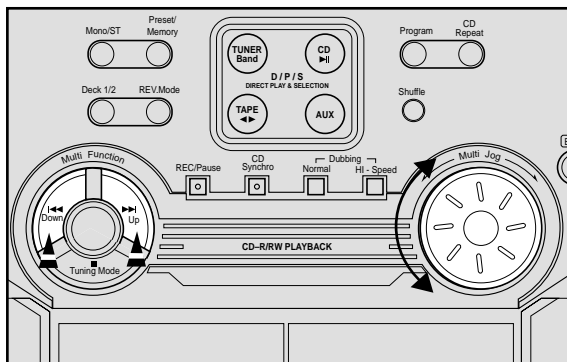

Remote Control

Press the **Tune/CD Mode** button, then select **'Title'** or **'Track'** and press the **⏮**, **⏭** button.

- ♦ If **'Title'** is selected in the display, the title moves.
- ♦ If **'Track'** is selected in the display, the track moves.

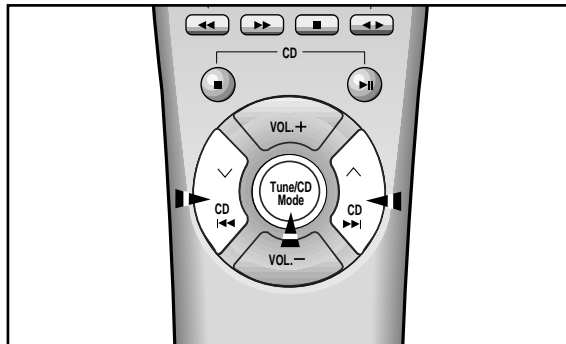

What is MP3?

MP3 means MPEG1 Layer 3, the global standard for audio signal compression technology. It uses digital compression technology to compress original sound data by up to 12 times without sound quality degradation.

File Compatibility

- ◆ The unit will playback files created in MP3 format (Mpeg1.Layer3) with *.mp3 as their extension.
- ◆ Files created in MP2 format (Mpeg1.Layer2) with *.mp2 as their extension can also be played back.

How many MP3 files can a CD-R or CD-RW disc record?

The maximum capacity of one CD-R or CD-RW disc is 680MB.

Normally, one MP3 file has a capacity of 4MB, therefore approximately 170 files can be recorded on a single disc.

Regarding the playback of CD-R/RW

- ◆ In the case of an original CD-R(Recordable) recorded in audio CD format, CD-RW(Rewritable) and editing by the user, playback is processed on the respective completed status. (The player may not be played back according to the characteristics of the CD or recorded status.)
- ◆ The CD-RW is comparably less reflexive than CD which causes more time delay to read.

Playback sequence of titles and tracks

- ◆ In case of Window Explorer display.
- ◆ The arrows indicates playback sequence of titles and tracks.
- ◆ Tracks with jpg, wav or doc only are not audio files and therefore will be skipped.

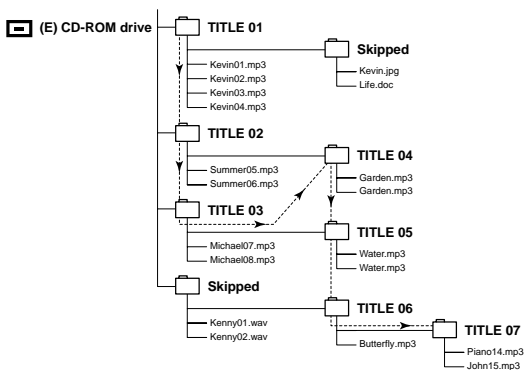

Searching for a Specific Music Passage on a CD

When listening to a compact disc, you can quickly search for a specific music passage on a track.

- It is recommended that you turn the volume down before using this function.

To search through the tracks...	Press and hold down...
Forwards	▶▶ for at least one second
Backwards	◀◀ for at least one second

You can also press and hold down ◀◀ / ▶▶ on the front panel to auto search through the tracks.

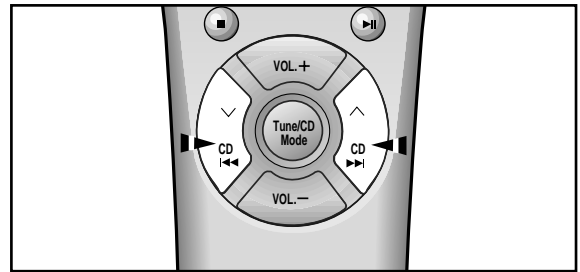

Function to skip through 10 tracks at a time

Press the +10 button briefly while playing back a CD. The track 10 tracks after the current one will then be played back.

Example: If you want to select track 43 during playback of track 15, press the +10Key button three times, and then press the ▶▶ button three times.

15 → 20 → 30 → 40 → 41 → 42 → 43

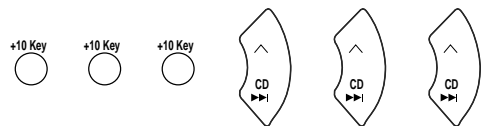

Last Memory Function

*This function is only available during playback of an MP3-CD.

When CD playback is selected again after your CD player has been stopped or turned off, this function allows playback from the start of the track that you last listened to.

- ◆ Press the Program button while your MP-3 CD is being played back. The **Last ON** and **OFF** may be repeatedly selected.

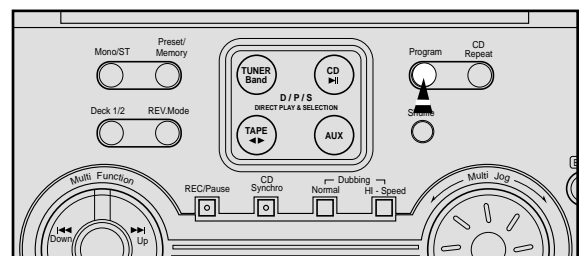

Shuffle Play Function

You can listen to the tracks on a compact disc in a different order each time, as the various tracks will be selected automatically in a random sequence.

- 1 Press the **Shuffle** button.
Result: The Shuffle indication appears and all the tracks are played in a random order. Both the track number and the playing time are displayed.
 - ◆ If this button is pressed when the CD is being played back or stopped, any track recorded in the CD may be selected to playback again.
 - ◆ The CD plays back without repetitions and in the case of the MP3-CD, a track once played back may also be played back again repeatedly.
- 2 When playing tracks in a random order, you can:
 - ◆ Move on to the next track (selected at random) by pressing **◀▶** or turning **Multi Jog** one notch to the right
 - ◆ Search quickly for a specific point in the current track by pressing **◀▶** or turning **Multi Jog** one notch to the left
- 3 When you have finished the random playback, press **■** or press the **Shuffle** button again.

➤ The Repeat and CD Synchro function is not supported from the Shuffle playback mode.

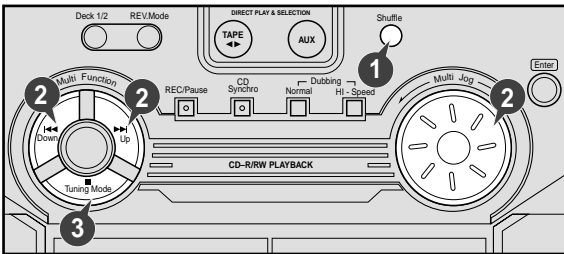

Repeating One or All Tracks on the Compact Discs

You can repeat indefinitely:

- ◆ A specific track on a compact disc.
- ◆ All tracks on the compact disc selected.
- ◆ All discs loaded in the carousel

- 1 **To repeat...** **Press CD Repeat on the Front Panel one or more times until...**

The current track indefinitely **REPEAT 1** is displayed
 The selected disc **REPEAT 1 CD** is displayed
 All discs loaded **REPEAT ALL CD** is displayed

- 2 When you wish to stop the Repeat function, press **CD Repeat** until **ALL CD** or **1 CD** is displayed, or press **■**.

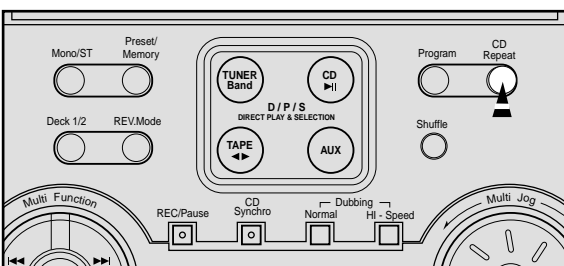

Programming the Order of Playback

(This function is not only available during playback of an MP3-CD.)

You can decide:

- ◆ The order of the track desired to listen
- ◆ The track not desired to listen
- ◆ A maximum of up to 24 order of tracks desired to listen may be programmed.
 - ◆ Before selecting the track, the CD player should be stopped.
 - ◆ This function may be used simultaneously with the CD Repeat function.
 - ◆ In the case of the MP3-CD, the Program button may be used as the Last Memory ON, OFF function.

- 1 If the CD function is selected, stop the player by pressing **■**.
- 2 Load the selected CDs.
- 3 Press **Program**.
Result: The following indications are displayed:
 PRGM 01 PR 01 ---
 (01 = Program no., 01 = Disc no., --- = Track no. on the disc)
- 4 If necessary, select the disc containing the required track by pressing the corresponding **Disc (1, 2, 3)** button.
- 5 Select the required track by turning the **Multi Jog** knob:
 - ◆ To the left to move back through the tracks
 - ◆ To the right to move forward through the tracks
- 6 Press **Program** to confirm your selection.
Result: The selection is stored and **PRGM 02 PR 01 ---** is displayed.
- 7 To select other tracks, repeat Steps 4 to 6.
- 8 Press **CD (▶||)** to listen to the track selection in the order programmed.
- 9 **To...** **Turn the Multi Jog knob...**

Listen to the current track again	One notch to the left
Listen to the previous track	Two notches to the left
Listen to the next track	One notch to the right
Skip forwards or backwards one or more tracks	The appropriate number of notches to the right or to the left

- 10 To cancel the selection, press **■**.
 - ◆ Once if the compact disc player is stopped
Result: **PRGM** is no longer displayed.
 - ◆ If you open the compartment, the selection is cancelled.
 - ◆ If you select the number of a disc which is not loaded or a track which does not exist on the CD, the selection skips to the next programmed track.
 - ◆ You can also use the **◀▶** buttons to select the required tracks in step 5, 9.

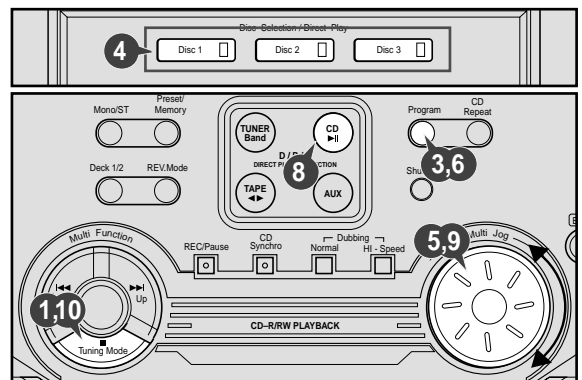

Checking or Changing Programmed Tracks

You can check or change your selection of tracks at any time.

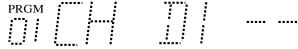
- 1 Press **■** once if you have started listening to the selection.
- 2 Press **Program**.
Result: The following indications are displayed:

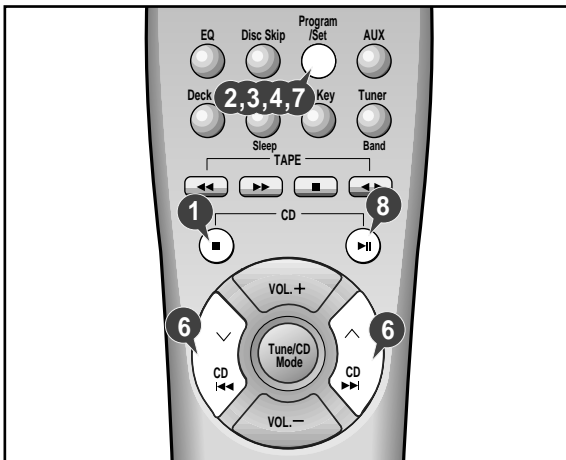
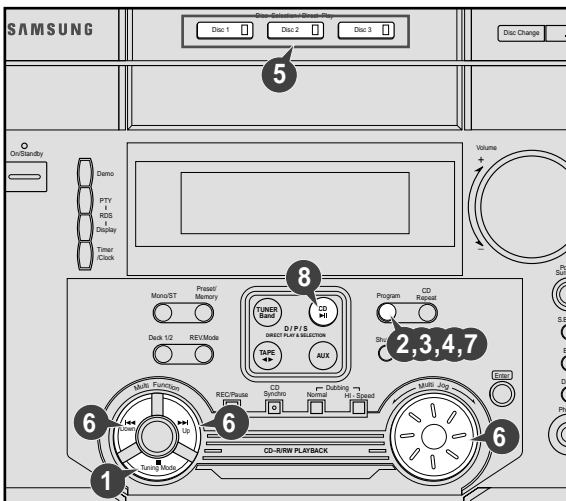
(CH = Check, 01=Program No, 01 = Disc No, --- = Track No on the disc)
➤ If you have already programmed 24 tracks, **CH** is displayed instead of **PR** when you press **Program**.
- 3 Press **Program** again.
Result: The first track selected is displayed, together with the letter **CH** (Change).
- 4 Press **Program** one or more times until the track to be changed is displayed.
- 5 If necessary, press the corresponding **Disc (1, 2, 3)** button to change discs.
- 6 Press **◀▶** and **▶▶** or turn **Multi Jog** to select a different track.
- 7 Press **Program** to confirm your change.
- 8 Press **CD (▶▶)** to start listening to the selection.
Result: The first track selected is played.



Searching for and Storing the Radio Stations

You can store up to:

- ◆ 15 FM stations
- ◆ 8 MW stations
- ◆ 7 LW stations

- 1 Switch the system on by pressing **On/Standby**.
- 2 Select the **TUNER** function by pressing **TUNER**.
- 3 Select the required frequency band by pressing **TUNER (Band)** again on the front panel or **Tuner (Band)** on the remote control.
Result: The appropriate indication is displayed:

◆ FM	Frequency Modulation
◆ AM(MW)	Medium Wave
◆ LW	Long Wave
- 4 To search for a station... Press Tuning Mode

Manually	One or more times until MANUAL is displayed.
Automatically	One or more times until AUTO is displayed.
- 5 Select the station to be stored by:
 - ◆ Turning the **Multi Jog** knob to the right or to the left to increase or decrease the frequency respectively
 - or
 - ◆ Pressing **Tuning** **∨** or **∧** on the remote control
 - ◆ To scroll through the frequencies faster when searching manually, hold down the **Tuning Down** or **Up** buttons.
 - ◆ The automatic search procedure may stop on a frequency that does not correspond to a radio station. If this happens, use the manual search mode.
- 6 Adjust the volume by:
 - ◆ Turning the **Volume** knob on the front panel
 - or
 - ◆ Pressing the **VOL. +** or **-** buttons on the remote control
- 7 Select the stereo or mono mode by pressing **Mono/ST**.

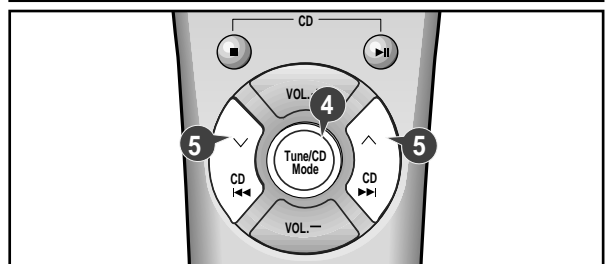
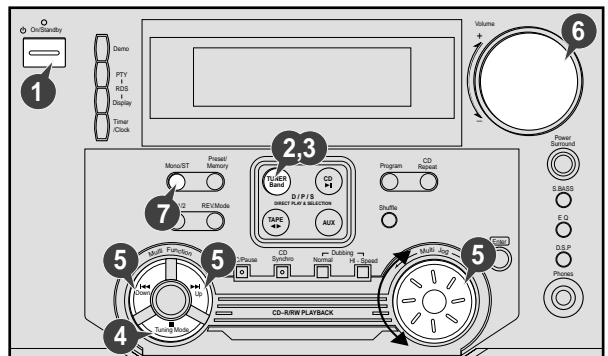

Searching for and Storing the Radio Stations (continued)

GB

- 8 If you do not want to store the radio station found, revert to Step 4 and search for another station.
Otherwise:
- Press **Preset/Memory**.
Result: The **PRGM** is displayed for a few seconds.
 - Press **Tuning Down** and **Up** to assign a program number between 1 and 15.
 - Press **Preset/Memory** to store the radio station.
Result: **PRGM** is no longer flashed and the station is stored.
- 9 To store any other radio frequencies required, repeat Steps 3 to 8.

➤ ♦ The PROGRAM function can be used to assign a new station to an existing program number.

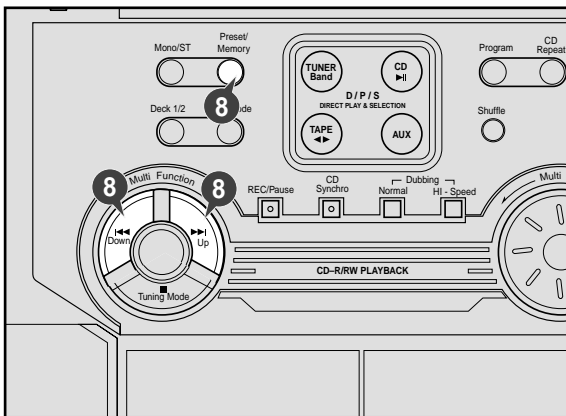

Selecting a Stored Station

You can listen to a stored radio station as follows:

- Switch the system on by pressing **On/Standby**.
- Select the **TUNER** function by pressing **Tuner** on remote control.
- Select the required frequency band by pressing **Tuner (Band)** on the remote control or **TUNER (Band)** again on the front panel.
- Press the **Tuning Mode** button on the front panel of the unit, or the **Tune/CD Mode** button on the remote control until **"PRESET"** is displayed.
- Turning **Multi jog** on the front panel left or right until the desired station is found or press **◀/▶** to select the desired station. or
Select the desired station by pressing the station number stored, using the **Tuning** **∨** or **∧** button on the remote control.
Result: The desired station is now received.

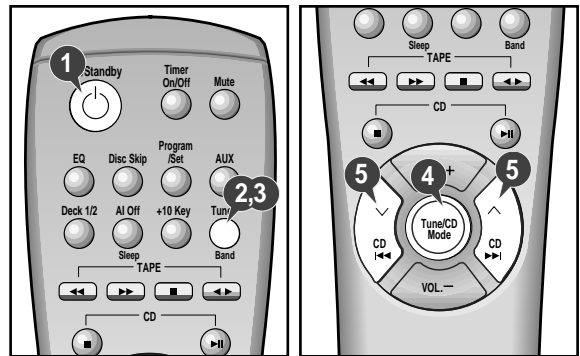

Improving Radio Reception

You can improve the quality of radio reception by:

- ♦ Rotating the FM or AM(MW) aerial
 - ♦ Testing the positions of the FM and AM(MW) aerials before fixing them permanently
- If reception from a specific FM radio station is poor, press **Mono/ST** to switch from stereo mode to mono. The quality of the sound will be improved.

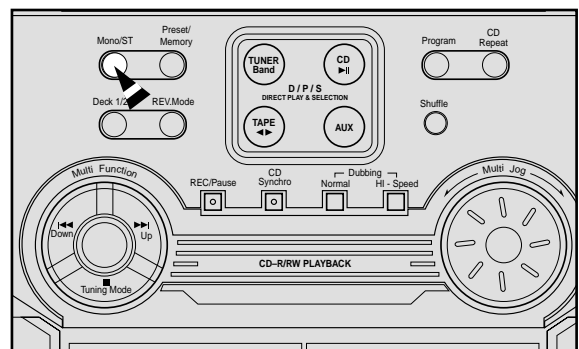

About RDS broadcasting

This unit has the RDS (Radio Data System) function, which enables for the various information such as broadcasting station, radio text, time and 30 types of programs (News, Rock, Classic, etc.) to be received from the FM RDS station together with normal radio signal.

- 1 Press the **On/Standby** button.
- 2 Receive the **FM** radio.
 - ◆ See the radio receiving method on the **page 15**.
 - ◆ **FM** and frequency are shown on the display
 - ◆ If the received station transfers the RDS information, 'RDS' appears automatically on the display.
- 3 Press the **RDS Display** button to select the desired RDS mode.
 - ◆ Whenever the button is pressed, RDS mode changes as follows.

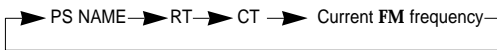

◆ The RDS function is available only in **FM** broadcasting.

➤ Description on RDS function

1. **PTY** (Program Type) : Displays the type of programme currently being broadcast
2. **PS NAME** (Program Service Name) : Indicates the name of broadcasting station and is composed of 8 characters.
3. **RT** (Radio Text) : Decodes the text broadcast by a station (if any) and is composed of maximum 64 characters.
4. **CT** (Clock Time) : Decodes the real time clock from the **FM** frequency.
 - Some stations may not transmit PTY, RT or CT information therefore this may not be displayed in all cases.
5. **TA** (Traffic Announcement) : When this symbol flashes it shows that the traffic announcement is in progress.
6. **EON** (Enhanced Other Networks Information) : Offers the RDS information on other networks.

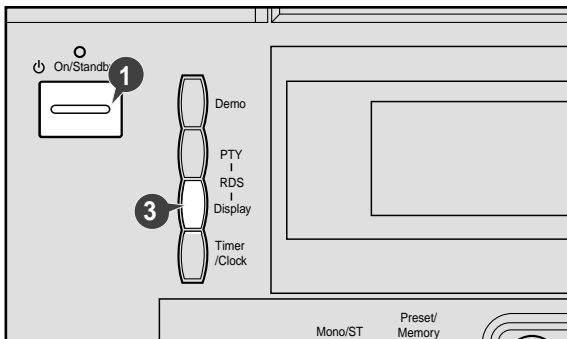

About RDS DISPLAY function

About "PS NAME" MODE

➤ Displays the name of broadcasting station.

Press the RDS Display button to select the PS NAME.

- ◆ **"PS NAME"** appears on the display.
- ◆ If the PS information is being received, the PS name (BBC, AFO, NDR, etc.) is shown on the display.
- ◆ If the PS information isn't received, the original **FM** frequency is shown.

◆ Even though no RDS Display button is pressed, the reception of PS information ensues the PS name is displayed.

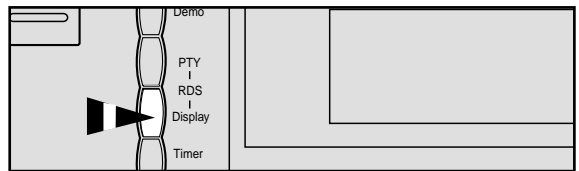

About 'RT' MODE

➤ Displays the character transmitted from the broadcasting station.

Press the RDS Display button to select the RT MODE.

- ◆ **"RT"** appears on the display.
- ◆ If the RT information is being received, the received information is shown on the display.
- ◆ If the RT information isn't received, the **"NO RT"** is shown. On the display.

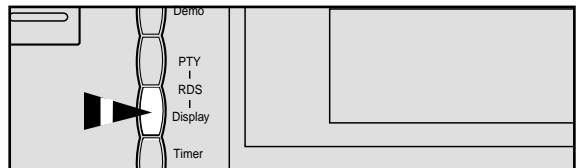

About CT(Clock Time)

➤ Sets the time of RDS clock.

To select the CT time, set the RDS Display button to CT MODE.

- ◆ The CT information will take up to 2 minutes to be decoded therefore the clock isn't displayed immediately.
- ◆ If there is no received CT information, **"NO CT"** is displayed.

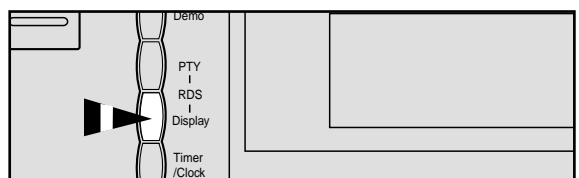

PTY (Program Type) indication and PTY-SEARCH function

GB



- ◆ The PTY information is composed of an identification symbol, which helps the **FM** radio to recognize the program type of each **FM** station.
- ◆ The 30 PTY modes are shown in the display by pressing the PTY button.

Display	Program Type
NEWS	• News including an announced opinion and report
AFFAIRS	• Several matters including a current incident, documentary, discussion and analysis.
INFO	• Information including weights and measures, returns and forecast, matters interesting the customer, medical information, etc.
SPORT	• Sports
EDUCATE	• Education
DRAMA	• Drama-Radio serial, etc.
CULTURE	• Culture-National or local culture including the religious problem, social science, language, theater, etc.
SCIENCE	• Natural science and technology
VARIED	• Others-Speech, amusing program (quiz, game), interview, comedy and satirical play, etc.
POP M	• Pop music
ROCK M	• Rock music
M.O.R.M	• M.O.R- Comfortable music, occasionally vocal or piece
LIGHT M	• Light classical music- Classical music and instrumental and chorus music
CLASSIC	• Heavy classical music-Orchestra music, symphony, chamber music and opera
OTHER M	• Other music - Jazz, R&B country music
WEATHER	• Weather
FINANCE	• Finance
CHILDREN	• Children's programmes
SOCIAL A	• Social affairs
RELIGION	• Religion
PHONE IN	• Phone in
TRAVEL	• Travel
LEISURE	• Leisure
JAZZ	• Jazz Music
COUNTRY	• Country Music
NATIONAL M	• National Music
OLDIES	• Oldies Music
FOLK M	• Folk Music
DOCUMENT	• Documentary
TEST	• Alarm Test

About PTY-SEARCH

- 1 Tuned to an **FM** station broadcasting a PTY MODE.
 - ◆ See the **FM** receiving method on the **page 15**.
 - ◆ If the received station is transmitting the RDS information, "RDS" lights up.
 - 2 Press the **PTY** button.
 - ◆ The PTY MODE(NEWS, AFFAIRS, etc) appears on the display.
 - ◆ Press the **Tuning Down** or **Up** button to select the desired PTY MODE.
- ◆ If the station is transmitting no PTY information, 'NO PTY' shows on the display.
- ◆ When the PTY MODE is selected(The PTY MODE is shown in the display), press the PTY KEY once again to convert into PTY-SEARCH MODE and auto-search the station sequentially.
- ◆ If a station is found broadcasting required PTY MODE then the search station and the stop is selected.
- 👁 ◆ If the PTY MODE isn't found it is retuned to the original station frequency at beginning the PTY SEARCH and auto-search and PTY SEARCH are suspended.

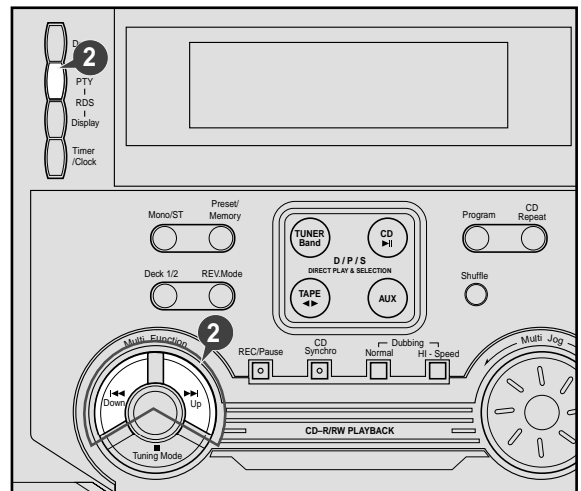

Listening to a Cassette

- Always treat your cassettes with care; refer, if necessary, to the section entitled "Precautions When Using Audio Cassettes" on page 25.

- 1 Switch the system on by pressing the **On/Standby** button.
- 2 Select the TAPE function by pressing **TAPE** on the front panel.
- 3 Open either cassette deck 1 or 2 by pushing and releasing the deck cover where **PUSH EJECT** (▲) is written.
- 4 Insert the pre-recorded cassette with the open edge of the tape facing downward.
- 5 Close the deck by pushing on it until it clicks into place.
Result: Depending on the deck selected, the 1 or 2 indication is displayed in front of the counter number.
- 6 If you have inserted two cassettes, press **Deck 1/2** on the front panel or directly the **Deck 1/2** button on the remote control to select the cassette to be played.
Result: Depending on the deck selected, the TAPE 1 or TAPE 2 indication is displayed.

- | To listen to... | Press ... |
|-----------------|----------------------|
| Side A | TAPE (▶) once |
| Side B | TAPE (◀) twice |
- Result:** The cassette starts playing.

- 8 When the cassette is stopped, select one of the following functions as required.

To...	Press ...
Rewind the cassette	◀◀
Fast-forward the cassette	▶▶

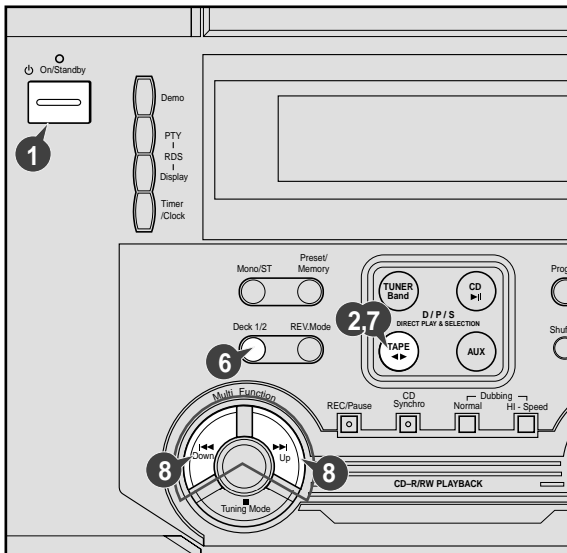

CD Synchro Record Feature

(This function is not only available during playback of an MP3-CD.)

You can record a compact disc on a cassette in two different ways:

- ◆ Synchronised recording
- ◆ Direct recording

This feature enables you to synchronize the start of the recording with the start of the disc or track of your choice.

- 1 Switch the system on by pressing **On/Standby**.
- 2 Insert a blank cassette in Deck 2.
- 3 Select the CD function by pressing **CD** on the front panel.
- 4 Load a compact disc.
- 5 Select the required disc.
- 6 Select the required track and press **CD Synchro** or press **CD Synchro** directly to start recording at the beginning of the disc.
Result: REC is displayed and recording starts.
- 7 To stop recording, press ■.

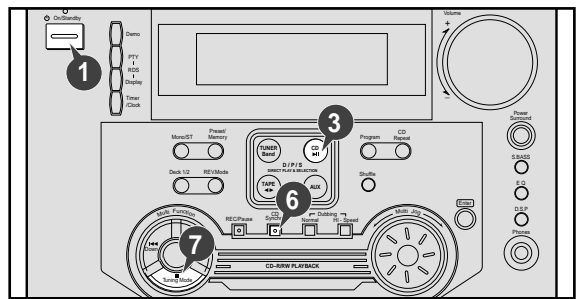

Recording a Compact Disc

The direct recording mode enables you to start recording with any track on the compact disc.

- ◆ You can only record on cassettes in Deck 2.
- ◆ You do not need to adjust the volume, as it has no effect on the recording.

- 1 Switch your system on by pressing **On/Standby**.
- 2 Insert a blank cassette in Deck 2.
- 3 Select the CD function by pressing **CD** on the front panel.
- 4 Load the compact disc.
- 5 Select the required disc.
- 6 Select the required track on the compact disc and press ▶|| on the front panel or ▶|| on the remote control to set the compact disc player to Pause mode.
- 7 Press the **REC/Pause**.
- 8 **Result:** REC is displayed.
Press the ▶|| to start playing the track.
Result: The track is recorded on the cassette.
- 9 To stop recording, press ■.

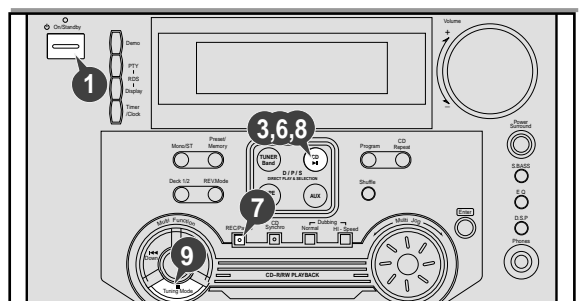

Recording a Radio Program



You can record a radio program of your choice.

- ◆ You can only record on cassettes in Deck 2.
- ◆ You do not need to adjust the volume, as it has no effect on the recording.

- 1 Switch the system on by pressing **On/Standby**.
- 2 Insert a blank cassette in Deck 2.
- 3 Select the **TUNER** function by pressing **TUNER**.
- 4 Select the radio station that you wish to record by pressing **Tuning Up** or **Tuning Down** on the remote control or by press the **Tuning Down** or **Up** on the front panel.
- 5 Press **REC/Pause**.
Result: REC is displayed in red and recording starts.
- 6 To stop recording, press ■.

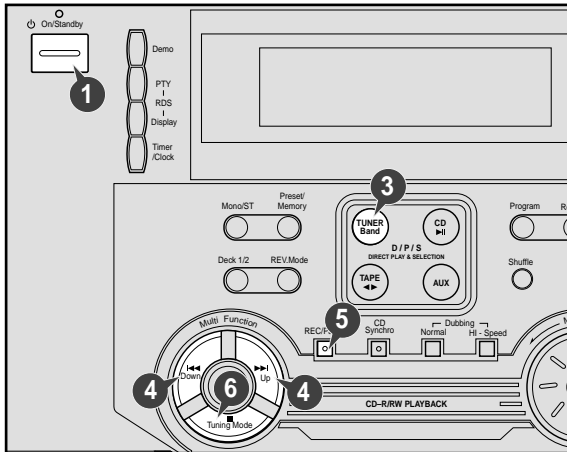

- 5 To stop dubbing, press ■.

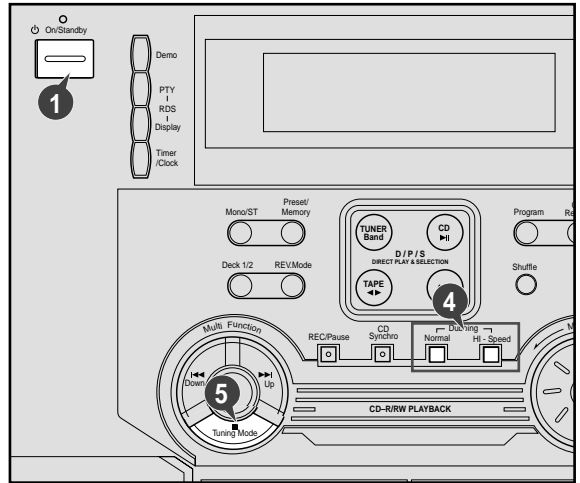

Selecting the Cassette Playback Mode (Deck 2 Only)

Your mini-compact system has three cassette playback modes which enable you to listen to both sides of a cassette automatically. Press REV.Mode until the appropriate symbol is displayed.

When the display indicates... The mini-compact system plays back...

- One side of the selected cassette and then stops.
- One side of the cassette. The other side of the cassette and then stops.
- Both sides of the cassette indefinitely until you press stop.

Copying a Cassette (Dubbing)

You can copy a cassette from Deck 1 to Deck 2. Two options are available:

- ◆ Normal speed dubbing
- ◆ High-speed dubbing
- You do not need to adjust the volume, as it has no effect on the recording.
- ◆ Take care not to insert the tape to be copied in Deck 2, as it will be erased when you start recording.

- 1 Switch your system on by pressing **On/Standby**.
- 2 Insert a blank cassette in Deck 2.
- 3 Insert the tape to be copied in Deck 1.
- 4 **To copy a cassette at... Press...**

Normal speed	Normal Dubbing
High speed	Hi-Speed Dubbing

Result: The appropriate indications are displayed and the cassette in Deck 1 is copied to the cassette in Deck 2.

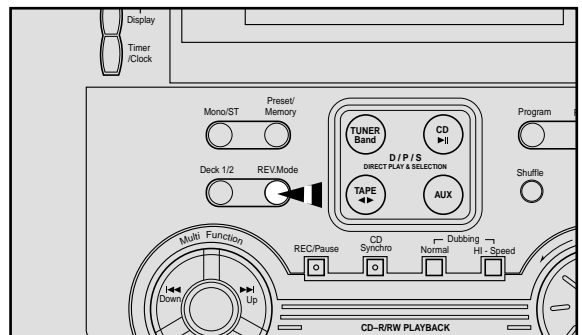

Timer Function

The timer enables you to switch the system on or off at specific times.

Example: You wish to wake up to music every morning.

- If you no longer want the system to be switched on or off automatically, you must cancel the timer.
- ☛ ♦ Before setting the timer, check that the current time is correct.
- ♦ For each step, you have a few seconds to set the required options. If you exceed this time, you must start again.

- 1 Switch the system on by pressing **On/Standby**.
- 2 Press **Timer/Clock** until ☹ **TIMER** is displayed.
- 3 Press **Enter**.
Result: **ON TIME** is displayed (instead of the equalizer symbols) for a few seconds, followed by any switch-on time already set; you can set the timer switch-on time.
- 4 Set the timer switch-on time.
 - a Set the hour by tuning the **Multi Jog** knob to the right or to the left.
 - b Press **Enter**.
Result: The minutes flash.
 - c Set the minutes by tuning the **Multi Jog** knob to the right or to the left.
 - d Press **Enter**.
Result: **OFF TIME** is displayed (instead of the equalizer symbols) for a few seconds, followed by any switch-off time already set; you can now set the timer switch-off time.
- 5 Set the timer switch-off time.
 - a Set the hour by tuning the **Multi Jog** knob to the right or to the left.
 - b Press **Enter**.
Result: The minutes flash.
 - c Set the minutes by tuning the **Multi Jog** knob to the right or to the left.
 - d Press **Enter**.
Result: **VOL XX** is displayed, where **XX** corresponds to the volume already set.
- 6 Press **Tuning Down** and **Up** to adjust the volume level and press **Enter**.
Result: The source to be selected is displayed.
- 7 Turn the **Multi Jog** knob to select the source to be played when the system switches on.

If you select...	You must also...
TAPE (cassette)	Insert a recorded cassette in one of the decks before setting the system to standby.
TUNER (radio)	<ol style="list-style-type: none"> a Press Enter. b Select the FM or AM frequency band by tuning the Multi Jog knob to the right or to the left. c Press Enter. d Select a preset station by tuning the Multi Jog knob to the right or to the left.
CD (compact disc)	<ol style="list-style-type: none"> a Load one or more compact discs. b Select the required disc.

- 8 Press **Enter** to confirm the timer.
- 9 Press **On/Standby** to set the system to standby mode.
Result: ☹ is displayed to the bottom left of the time, indicating that the timer has been set. The system will switch on and off automatically at the required times.

➤ If the timer switch on and off times are identical, the word **ERROR** is displayed.

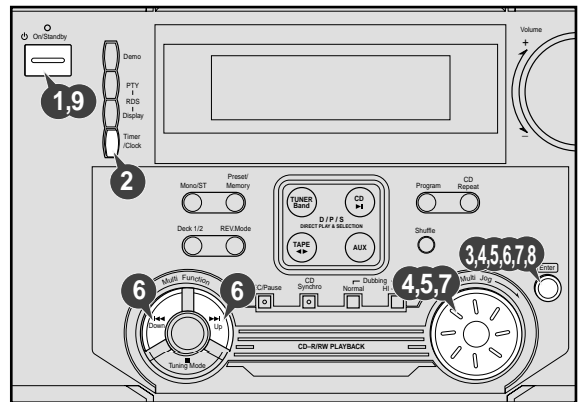

To set the timer function

- ♦ You may use **Multi Jog** or **◀▶** buttons to adjust in step 4, 5, 6, 7.
- ♦ You can also use **Program/Set** button on the remote control to instead **Enter** button in step 3, 4, 5, 6, 7, 8.

Cancelling the Timer

After having set the timer, it will start automatically as shown by the **TIMER** indication on the display. If you no longer wish to use the timer, you must cancel it.

➤ You can stop the timer at any time (system on or in standby mode).

To...	Press Timer On/Off...
Cancel the timer	Once. Result: ☹ is no longer displayed.
Restart the timer	Twice. Result: ☹ is displayed again.

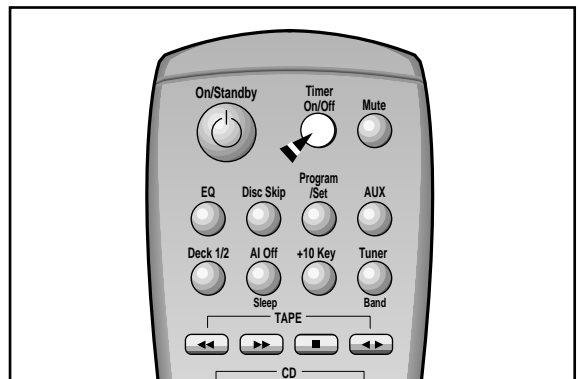

Mute Function



You can turn the sound off temporarily on your system.
Example: You wish to answer a telephone call.

- 1 Press **Mute**.
- 2 To switch the sound back on (at the same volume as before), press **Mute** again or the **Volume** buttons.

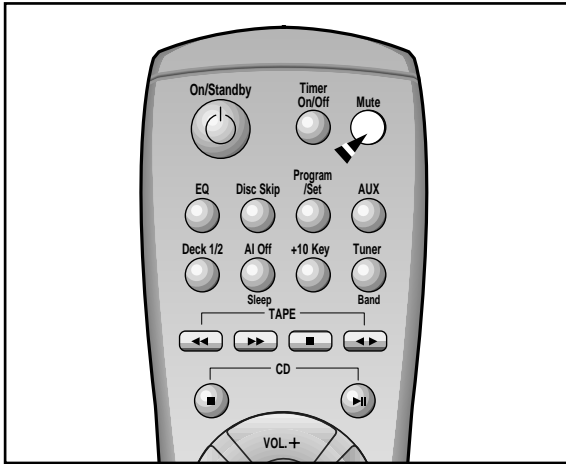

Power Sound/Surround Function

Your mini-compact system is equipped with the function of Power Sound and Power Surround.
 The function of Power Sound amplifies bass and improves high key or bass twice as much for you to appreciate powerful real sound.
 The Power Surround replaces conventional stereo sound with a wider and more ture-to-life sound. It creates the feeling of being right at the centre of the music and being surrounded by total music sound.

- Press Power Surround button on the front panel until the required option is selected. Each time the Power Surround button is pressed, "**P.SOUND, P.SURR, OFF**" are selected in this order.

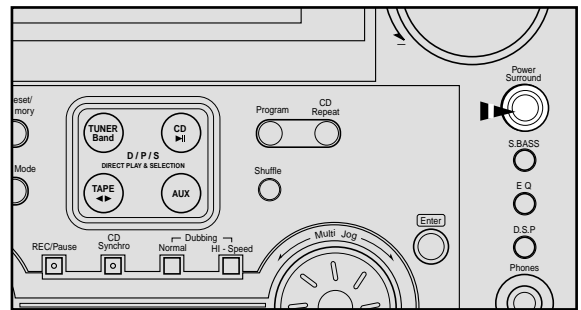

Selecting an Equalizer Preset

Your mini-compact system is equipped with a preset equalizer that allows you to choose the most appropriate balance between treble and bass frequencies, according to the type of music you are listening to.

Press **EQ** on the front panel or on the remote control until the required option is selected.

To obtain a...	Select...
Normal balance (linear)	PASS
Balance suitable for pop music	POP
Balance suitable for rock music	ROCK
Balance suitable for classic music	CLASSIC

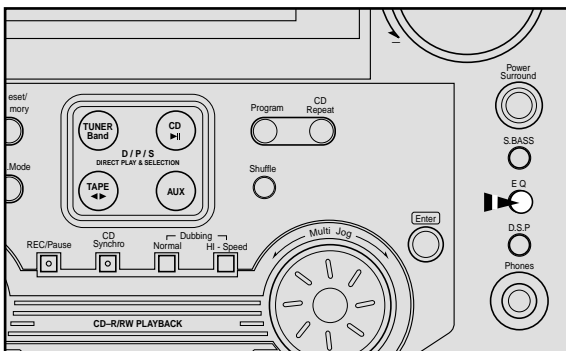

D.S.P Function

This model provides D.S.P modes so that you can enjoy virtually original sound.

- Press D.S.P on the front panel until the required option is selected. Each time the D.S.P button is pressed, "**CINEMA** (Cinema mood), **LIVE**(Live house sound), **HALL**(Concert hall mood), **PASS**" are selected in this order.

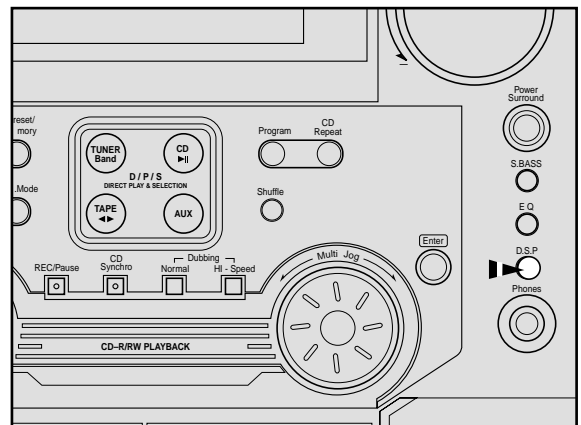

Setting the System to Switch off Automatically

While listening to a compact disc or a cassette, you can set the system to switch off automatically

Example: You wish to go to sleep to music.

- 1 Press **AI Off/Sleep**.
Result: playback starts and the following indications are displayed:
90 MIN
- 2 Press **AI Off/Sleep** one or more times to indicate how long the system should continue playing before it switches off:

(AI SLEEP)	→ 90 MIN	→ 60 MIN	→ 45 MIN
← OFF	← 15 MIN	← 30 MIN	

➤ At any time, you can:

 - ◆ Check the remaining time by pressing **AI Off/Sleep**
 - ◆ Change the remaining time by repeating Steps 1 and 2
- 3 Press **AI Off/Sleep** one or more times until **AI SLEEP** is displayed.
Result: The system will automatically switch off at the end of the disc or cassette.
- 4 To cancel **SLEEP** or **AI OFF** function, press **AI Off/Sleep** one or more times until **OFF** is display.

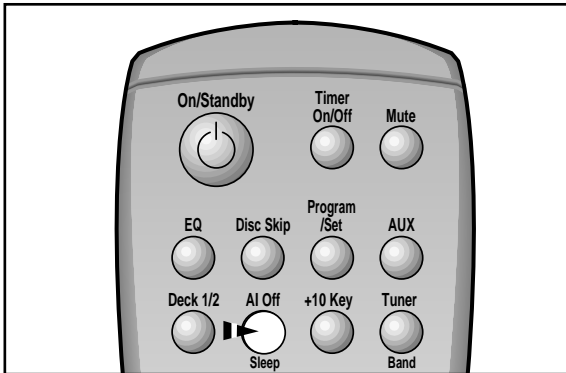

Super Bass Sound

Your mini-compact system has a bass amplification function called S.Bass (Super Bass Sound). This function makes the sound more powerful and real.

- 1 Press the **S. BASS** button on the front panel.
Result: **S. BASS** is displayed and **"SBS ON"** is displayed for a few seconds.
- 2 To cancel this function, press **S. BASS** again.

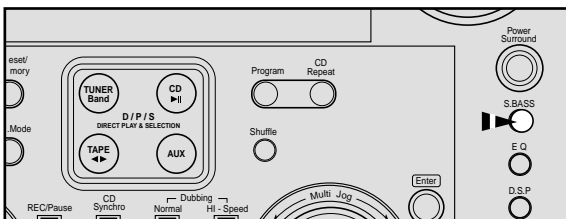

Connecting Headphones

You can connect a set of headphones to your mini-compact system so that you can listen to music or radio programmers without disturbing other people in the room. The earphones must have a 3.5 mm jack or an appropriate adapter.

Connect the headphones to the **Phones** jack on the front panel.
Result: The loudspeakers are no longer used to output the sound.

⚠ Prolonged use of headphones at a high volume may damage your hearing.

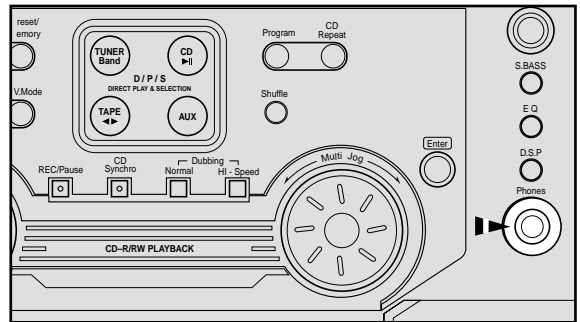

Safety Precautions

GB

The following diagrams illustrate the precautions to be taken when using or moving your mini-compact system.

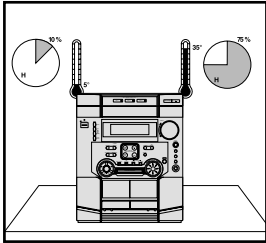

Ambient operating conditions:
Ambient temperature 5°C-35°C
Humidity 10-75%

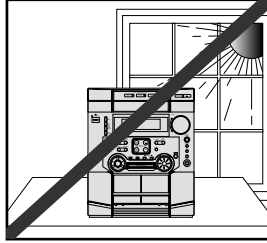

Do not expose the unit to direct sun radiation or other heat sources. This could lead to overheating and malfunction of the unit.

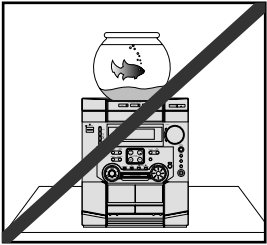

Do not place potted plants or vases on top of the unit. Moisture entering the unit could lead to dangerous electric shock and can cause equipment damage. In such events immediately disconnect the main plug from the socket.

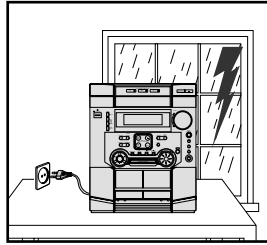

During thunderstorms, disconnect the main plug from the socket. Main voltage peaks due to lightning could damage the unit.

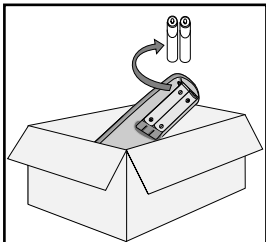

Remove the batteries from the remote control, if not used for any extended period. Leaking batteries can cause serious damage to the remote control.

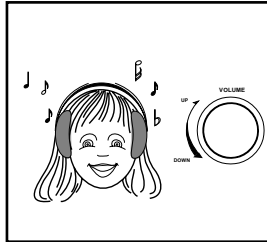

When using headphones, take care not to listen at excessive volumes. Extended use of headphones at high volumes will lead to hearing damage.

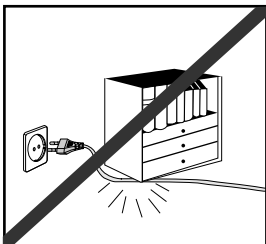

Do not place heavy items on the main lead. Main cable damage can lead to damage of the equipment (fire hazard) and can cause electric shock.

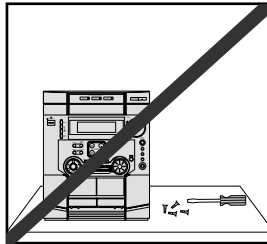

Do not remove any equipment panels. The inside of the unit contains live components, which cause electric shock.

Cleaning Your Mini-Compact System

To obtain the best possible results from your mini-compact system, you must clean the following elements regularly:

- ◆ The outer casing
- ◆ The compact disc player
- ◆ The cassette players (heads, rollers and drive capstans)
- ◆ Always unplug the system from the wall outlet:
 - ◆ Before cleaning it
 - ◆ If you are not going to be using it for a long time

Outer Casing

Clean the outer casing regularly using a soft cloth and a light detergent. Do not use abrasive powders, liquids or aerosol cleaners. Never let any liquids get into the system.

Compact Disc Player

- 1 Before playing a compact disc, clean it with a special CD cleaning agent. Do not use the same cleaning agents as for vinyl LP records. Carefully wipe the disc from the centre outward.
- 2 Regularly clean the player with a special cleaning disc (available from your local dealer).

Tape Decks

- 1 Press **Push Eject** (▲) to open the cassette deck.
- 2 Use a cotton bud and a special cassette cleaning agent to clean the:
 - ◆ Head (1)
 - ◆ Rollers (2)
 - ◆ Drive capstans (3)

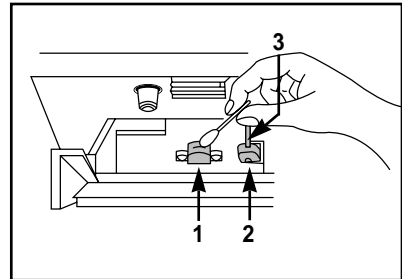

- ◆ If you will not be using the remote control for a long time, remove the batteries to prevent corrosion.
- ◆ Although your system is very hard-wearing, it should not be used in an excessively dusty environment or subjected to shocks or extreme heat (close to heating appliances or in direct sunlight, etc.).
- ◆ If the unit emits an unpleasant odor when in use, unplug it from the main supply and contact the after-sales service.

Precautions When Using Compact Discs

- ◆ Handle your compact discs with care. Always hold them by the edges to avoid leaving fingerprints on the shiny surface.
- ◆ When you have finished playing a compact disc, always put it back in its case.
- ◆ Do not fix paper or adhesive tape to the discs and do not write on the label.
- ◆ Clean them with a special-purpose cloth.
- ◆ Store your compact discs in a clean place, out of direct sunlight, where they will not be exposed to high temperatures.
- ◆ Always use compact discs marked  .

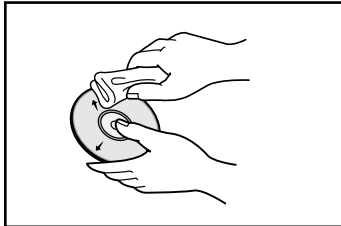

Precautions When Using Audio Cassettes

- ◆ Check that the tape in the cassette is sufficiently taut.
- ◆ To prevent erasing a cassette that you wish to keep, remove the safety tab on the upper edge of the cassette. To record a cassette, where the tab has been broken, simply cover the opening with adhesive tape.
- ◆ When you have finished playing a cassette, always put it back in its case.
- ◆ Store your cassettes in a clean place, out of direct sunlight, where they will not be exposed to high temperatures.
- ◆ Avoid using 120-minute cassettes as they place unnecessary strain on the tape mechanism.

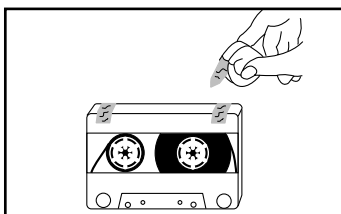
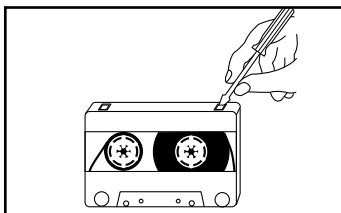
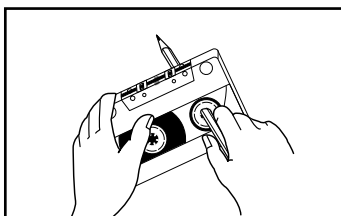

Before Contacting the After-Sales Service

GB

It always takes a little time to become familiar with a new appliance. If you have any of the problems listed below, try the solutions given. They may save you the time and inconvenience of an unnecessary service call.

Problem	Checks/Explanation
The system does not work	<ul style="list-style-type: none"> • The main lead is not correctly plugged into a wall socket or the wall socket is not switched on. • The remote control batteries need replacing or the polarity has not been respected. • The On/Standby button has not been pressed.
There is no sound	<ul style="list-style-type: none"> • The volume has been completely turned down. • The correct function (TUNER, CD, TAPE, AUX) has not been selected. • You have connected a set of earphones. • The loudspeaker wires have been disconnected. • The Mute button has been pressed.
The Timer does not work	<ul style="list-style-type: none"> • The timer has been stopped by pressing Timer On/Off.
In case it does not work, even the action is taken as above.	<ul style="list-style-type: none"> • Press the S.BASS button for 5 seconds in power 'OFF'(standby), then it is returned the original position (RESET)
The compact disc player does not start playing	<ul style="list-style-type: none"> • The CD function has not been selected. • The disc has been inserted face down or is either dirty or scratched. • The laser sensor is dirty or dusty. • The system has not been installed on a flat, horizontal surface. • Condensation has formed in the player; leave the system in a warm, airy room for at least one hour.
The mp-3 CD player cannot be played.	<ul style="list-style-type: none"> • Use the PC to confirm if the extension is *.mp3.
The tape does not start playing	<ul style="list-style-type: none"> • The TAPE function has not been selected. • The cassette has not been inserted correctly. • The cassette player has not been closed. • The tape is either slack or broken.
The volume falls off	<ul style="list-style-type: none"> • The audio heads are dirty.
The cassette is not erased correctly	<ul style="list-style-type: none"> • The rollers or drive capstans are dirty.
There is excessive wow and flutter	<ul style="list-style-type: none"> • The tape is worn.
Reception is poor or no radio stations are received at all	<ul style="list-style-type: none"> • The TUNER function has not been selected. • The radio frequency has not been correctly selected. • The aerial has been disconnected or is not facing the right way. Turn it until you find the best orientation. • You are in a building that blocks radio waves; you must use an outside aerial.

If the above guidelines do not allow you to solve the problem, take a note of:

- ◆ The model and serial numbers, normally printed on the rear of the system
- ◆ Your warranty details
- ◆ A clear description of the problem

Then contact your local dealer or SAMSUNG after-sales service.

Technical Specifications



SAMSUNG strives to improve its products at all times. Both the design specifications and these user instructions are thus subject to change without notice.

RADIO

LW

Usable sensitivity 60 dB

AM (MW)

Signal/noise ratio 40 dB

Usable sensitivity 54 dB

Total harmonic distortion 2 %

FM

Signal/noise ratio 62 dB

Usable sensitivity 10 dB

Total harmonic distortion 0.3 %

COMPACT DISC PLAYER

Capacity 3 discs

Frequency range 20 Hz - 20 KHz (± 1 dB)

Signal/noise ratio 90 dB (at 1 KHz) with filter

Distortion 0.05 % (at 1 KHz)

Channel separation 74 dB

Disc sizes Diameter: 120 or 80 mm. Thickness: 1.2 mm

TAPE DECK

Frequency range 125 Hz ~ 12 KHz

Signal/noise ratio 40 dB

Channel separation 35 dB

Erasing effect 60 dB

AMPLIFIER

Output power (6 Ω) 2 x 60 Watts RMS (total harmonic distortion: 10 %)

Channel separation 50 dB

Signal/noise ratio 75 dB

GENERAL

Dimensions 270 (W) x 332 (H) x 410 (D) mm

THIS APPLIANCE IS MANUFACTURED BY:

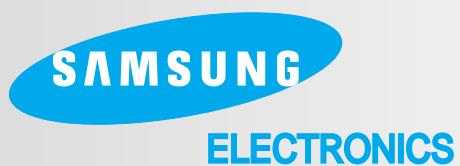

AH68-00768B

Free Manuals Download Website

<http://myh66.com>

<http://usermanuals.us>

<http://www.somanuals.com>

<http://www.4manuals.cc>

<http://www.manual-lib.com>

<http://www.404manual.com>

<http://www.luxmanual.com>

<http://aubethermostatmanual.com>

Golf course search by state

<http://golfingnear.com>

Email search by domain

<http://emailbydomain.com>

Auto manuals search

<http://auto.somanuals.com>

TV manuals search

<http://tv.somanuals.com>