

Some contents in this manual may differ from your device depending on the software of the device or your service provider.

To install Samsung Kies (PC Sync) Kies

1. Download the latest version of Samsung Kies from the Samsung website (www.samsung.com/kies) and install it on your computer.
2. Connect your device to a computer with a USB cable.
Refer to the Samsung Kies help for more information.

SAMSUNG

GT-P5110 user manual



Using this manual

Thank you for choosing this Samsung mobile device. This device will provide you with high-quality mobile communication and entertainment based on Samsung's exceptional technology and high standards.

This manual has been specially designed to guide you through the functions and features of your device.

Read me first

- Before using your device, read the entire manual and all safety instructions to ensure safe and proper use.
- The descriptions in this manual are based on the default settings of your device.
- The images and screenshots used in this manual may differ from the actual product.
- The contents of this manual may differ from the product, or from software provided by service providers or carriers, and are subject to change without prior notice. Access the Samsung website (www.samsung.com) for the latest version of the manual.
- Available features and additional services may vary by device, software, or service provider.
- Formatting and delivery of this manual is based on Android operating systems and may vary depending on the user's operating system.
- Applications on this device may perform differently from comparable computer applications and may not include all functions available in the computer version.
- Applications and their functions may vary by region or hardware specifications. Samsung is not liable for performance issues caused by third-party applications.

- Samsung is not liable for performance issues or incompatibilities caused by edited registry settings or modified operating system software. Attempting to customise the operating system may cause your device or applications to work improperly.
- You can upgrade your device's software by accessing the Samsung website (www.samsung.com).
- Software, audio, wallpapers, and images provided in this device are licensed for limited use between Samsung and their respective owners. Extracting and using these materials for commercial or other purposes is an infringement of copyright laws. Samsung is not liable for such copyright infringement by users.
- Please keep this manual for future reference.

Instructional icons

Before you start, familiarise yourself with the icons used in this manual:



Warning—situations that could cause injury to yourself or others



Caution—situations that could cause damage to your device or other equipment



Note—notes, usage tips, or additional information



Refer to—pages with related information; for example: ► p. 12 (represents “refer to page 12”)



Followed by—the order of options or menus you must select to perform a step; for example: In the application list, select **Settings** → **About device** (represents **Settings**, followed by **About device**)

Copyright

Copyright © 2012 Samsung Electronics

This manual is protected under international copyright laws. No part of this manual may be reproduced, distributed, translated, or transmitted in any form or by any means, electronic or mechanical, including photocopying, recording, or storing in any information storage and retrieval system, without the prior written permission of Samsung Electronics.

Trademarks

- SAMSUNG and the SAMSUNG logo are registered trademarks of Samsung Electronics.
- The Android logo, Google™, Google Maps™, Google Mail™, YouTube™, Google Play™ Store, and Google Talk™ are trademarks of Google, Inc.
- Bluetooth® is a registered trademark of the Bluetooth SIG, Inc. worldwide.
- Windows Media Player® is a registered trademark of the Microsoft Corporation.
- Wi-Fi®, Wi-Fi Protected Setup™, Wi-Fi Direct™, Wi-Fi CERTIFIED™, and the Wi-Fi logo are registered trademarks of the Wi-Fi Alliance.

- DivX[®], DivX Certified[®] and associated logos are trademarks of Rovi Corporation or its subsidiaries and are used under licence.

DivX[®]
HD

- All other trademarks and copyrights are the property of their respective owners.



CE 0168 

ABOUT DIVX VIDEO

DivX[®] is a digital video format created by DivX, LLC, a subsidiary of Rovi Corporation. This is an official DivX Certified[®] device that has passed rigorous testing to verify that it plays DivX video. Visit www.divx.com for more information and software tools to convert your files into DivX videos.

ABOUT DIVX VIDEO-ON-DEMAND

This DivX Certified[®] device must be registered in order to play purchased DivX Video-on-Demand (VOD) movies. To obtain your registration code, locate the DivX VOD section in your device setup menu. Go to vod.divx.com for more information on how to complete your registration.

DivX Certified[®] to play DivX[®] video up to HD 720p, including premium content.

Contents

Assembling	11
Unpack	11
Device layout	12
Keys	14
Charge the battery	14
Insert a memory card (optional)	17
Getting started	19
Turn on or off your device	19
Use the touch screen	20
Lock or unlock the touch screen and the keys	23
Get to know the Home screen	23
Access applications	28
Launch multiple applications	31
Customise your device	31
Enter text	36
Web and GPS-based services.....	38
Internet	38
Game Hub	42
Maps	42
Navigation	44
Local	44
Play Store	45
Readers Hub	46
Samsung Apps	46
S Suggest	47

YouTube	47
Voice Search	48
Communication	49
Google Mail	49
Email	51
Talk	53
ChatON	54
Messenger	55
Google+	55
Entertainment.....	56
Camera	56
Video Player	64
Gallery	67
Photo Editor	70
Video Editor	71
Music Player	73
Music Hub	76
Personal information	77
Contacts	77
S Planner	79
Memo	81
Connectivity.....	82
USB connections	82
Wi-Fi	84
Wi-Fi Direct	87
AllShare Play	88
Bluetooth	91

GPS	93
VPN connections	94

Tools..... 97

Alarm	97
Calculator	98
Downloads	98
Dropbox	99
My Files	100
Polaris Office	102
Google	104
World Clock	104

Settings 105

Access the setting options	105
Wi-Fi	105
Bluetooth	105
Data usage	105
More settings	106
Blocking mode	107
Sound	107
Display	107
Storage	108
Power saving mode	108
Battery	109
Application manager	109
Location services	109
Lock screen	109
Security	110
Language and input	111

Back up and reset	113
Add account	114
Accessory	114
Date and time	114
Accessibility	114
Developer options	116
About device	117
Troubleshooting	118
Index	121

Assembling

Unpack

Check your product box for the following items:

- Mobile device
- Quick start guide

 Use only Samsung-approved software. Pirated or illegal software may cause damage or malfunctions that are not covered by your manufacturer's warranty.

- 
- The items supplied with your device and available accessories may vary depending on your region or service provider.
 - You can buy additional accessories from your local Samsung retailer.
 - The supplied items are designed only for your device and may not be compatible with other devices.
 - Other accessories may not be compatible with your device.

Device layout

› Front view

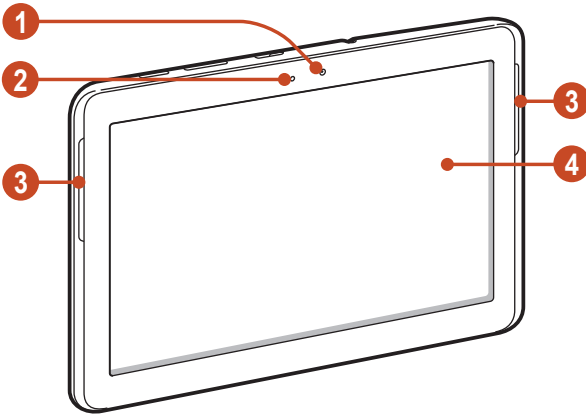

Number	Function
1	Front camera lens
2	Light sensor
3	Speaker
4	Touch screen

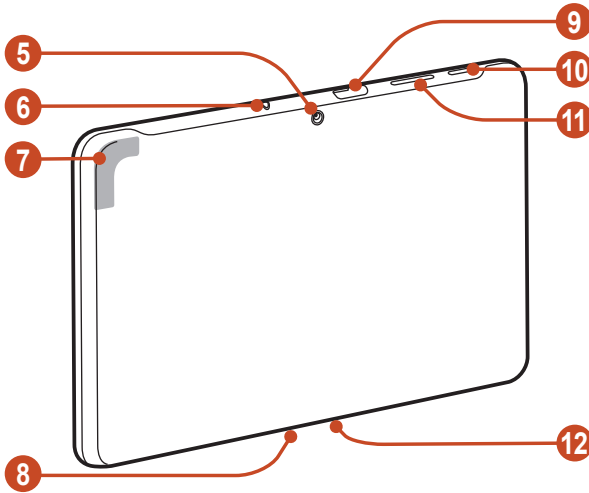

› Rear view



Number	Function
5	Rear camera lens
6	Headset jack
7	GPS antenna ¹
8	Microphone
9	Memory card slot
10	Power/Reset/Lock key
11	Volume key
12	Multifunction jack

1. Do not touch or cover the area around the antenna with your hands or other objects while using the GPS functions.

Keys

Key	Function
 Power/ Reset/ Lock	Turn on the device (press and hold); Access the device options (press and hold); Reset the device (press and hold for 8-10 seconds); Turn off and lock the touch screen or turn it on.
 Volume	Adjust the device's volume.

Charge the battery

Before using the device for the first time or when the battery has been unused for an extended period, you must charge the battery. Charge the battery only with a charger. You cannot charge the battery with a USB cable.

You cannot replace the battery in the device. If you have problems with the battery or need it replaced, take the device to a Samsung Service Centre.



Use only Samsung-approved chargers and cables. Unapproved chargers or cables may cause batteries to explode or damage your device.

1. If your device experiences fatal errors, hanging, or freezing, you may need to reset the device to regain functionality.



- When your battery is low, the device will emit a warning tone and show a low battery message. Recharge your battery to continue using your device.
- If the battery is completely discharged, you cannot turn on the device, even while it is charging. Allow a depleted battery to charge for a few minutes before you try to turn on the device.
- The shape of the USB power adapter may differ depending on your region.

I Connect the USB cable to the USB power adapter and then plug the end of the USB cable into the multifunction jack.

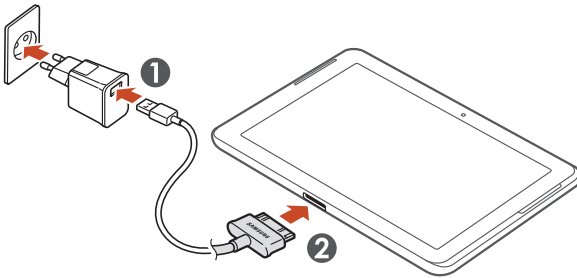

Connecting the USB cable improperly may cause serious damage to the device or USB power adapter. Any damage caused by misuse is not covered by the warranty.

2 Plug the USB power adapter into a power outlet.



- If the device receives an unstable power supply while charging, the touch screen may not function. If this happens, unplug the USB cable from the device.
- The device may heat up while charging. This is normal and should not affect your device's lifespan or performance.
- If your device is not charging properly, take your device and the charger to a Samsung Service Centre.

3 When the battery is fully charged, first unplug the USB cable from the device, and then unplug the USB power adapter from the electrical socket.



To save energy, unplug the USB power adapter when not in use. The USB power adapter does not have a power switch, so you must unplug the USB power adapter from the electrical socket when not in use to avoid wasting power. The device should remain close to the electrical socket while charging.

▶ Reduce the battery consumption

Your device provides options that help you save battery power. By customising these options and deactivating features in the background, you can use the device longer between charges:

- When you are not using your device, switch to Sleep mode by pressing the Power key.
- Close unnecessary applications with the task manager.
- Deactivate the Bluetooth feature.
- Deactivate the Wi-Fi feature.
- Deactivate auto-syncing of applications.
- Decrease the backlight time.
- Decrease the brightness of the display.

Insert a memory card (optional)

Your device accepts memory cards with maximum capacities of 32 GB. Depending on the memory card manufacturer and type, some memory cards may not be compatible with your device.

 Samsung uses approved industry standards for memory cards, but some brands may not be fully compatible with your device. Using an incompatible memory card may damage your device or the memory card. It may also corrupt data saved on the memory card.

-  • Your device supports only the FAT file structure for memory cards. If you insert a memory card formatted with a different file structure, your device will ask you to reformat the memory card.
- Frequent writing and erasing of data will shorten the lifespan of your memory cards.
- When you insert a memory card into your device, the memory card's file directory will appear in the extSdCard folder.

1 Open the cover of the memory card slot.

2 Insert a memory card with the gold-coloured contacts facing downwards.

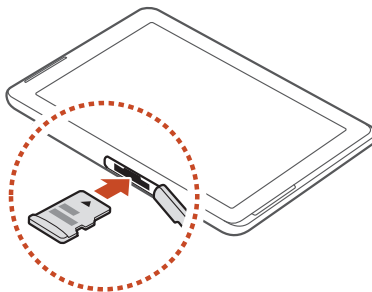

- 3 Push the memory card into the memory card slot until it locks in place.
- 4 Close the cover of the memory card slot.

› Remove a memory card

Ensure that the device is not currently accessing the memory card.

- 1 In the application list, select **Settings** → **Storage** → **Unmount SD card** → **OK**.
- 2 Open the cover of the memory card slot.
- 3 Push the memory card gently until it disengages from the device.
- 4 Remove the memory card.
- 5 Close the cover of the memory card slot.

 Do not remove a memory card while the device is transferring or accessing information, as this could result in loss of data or damage to the memory card or device.

› Format a memory card

Formatting your memory card on a computer may cause incompatibilities with your device. Format the memory card only on the device.

In the application list, select **Settings** → **Storage** → **Format SD card** → **Format SD card** → **Erase everything**.

 Before formatting the memory card, remember to make backup copies of all important data. The manufacturer's warranty does not cover loss of data resulting from user actions.

Getting started

Turn on or off your device

To turn on your device, press and hold the Power key.



If you are turning on your device for the first time, follow the on-screen instructions to set up your device. You must sign in to Google or create a Google account to use applications that interact with the Google server.

To turn off your device, press and hold the Power key, and then select **Power off** → **OK**.



- Follow all posted warnings and directions from approved personnel in areas where the use of wireless devices is restricted, such as aeroplanes and hospitals.
- To use only your device's non-network features, switch to Flight mode. ► p. 106

Use the touch screen

Your device's touch screen lets you easily select items or perform functions. Learn basic actions for using the touch screen.



- Do not press the touch screen with your fingertips, or use sharp tools on the touch screen. Doing so may damage the touch screen or cause it to malfunction.
- Do not allow the touch screen to come into contact with other electrical devices. Electrostatic discharges can cause the touch screen to malfunction.
- Do not allow the touch screen to come into contact with liquids. The touch screen may malfunction in humid conditions or when exposed to liquids.
- Leaving the touch screen idle for extended periods may result in afterimages (screen burn-in) or ghosting. Turn off the touch screen when you do not use the device.



- For optimal use of the touch screen, remove the screen protection film before using your device.
- Your touch screen has a layer that detects small electrical charges emitted by the human body. For best performance, tap the touch screen with your fingertip. The touch screen will not react to touches from sharp objects, such as a stylus or pen.

Control your touch screen with the following actions:

Tap

Touch once to select or launch a menu, option, or application.

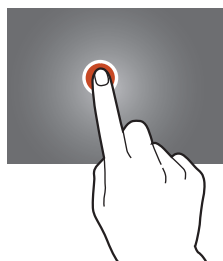

Tap and hold

Tap an item and hold it for more than 2 seconds.



Drag

Tap an item and move it to a new location.

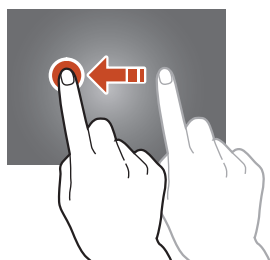

Double-tap

Tap an item twice quickly.



Flick

Briskly scroll up, down, left, or right to move through lists or screens.

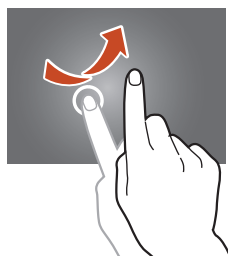

Pinch

Place two of your fingers far apart, and then pinch them together.

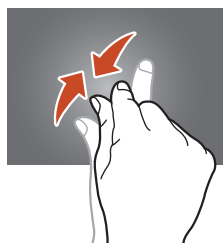

- Your device turns off the touch screen when you do not use it for a specified period. To turn on the screen, press the Power key.
- You can set the length of time that the device waits before turning off the screen. In the application list, select **Settings** → **Display** → **Screen timeout**.

Lock or unlock the touch screen and the keys

When you do not use the device for a specified period, your device turns off the touch screen and locks the touch screen and the keys automatically to prevent unintended operations. To lock the touch screen and the keys manually, press the Power key.

To unlock them, turn on the screen by pressing the Power key, tap anywhere on the screen, and then drag your finger outside of the large circle.



You can activate the screen lock feature to prevent others from using or accessing your personal data and information saved in your device. ► p. 34

Get to know the Home screen

From the Home screen, you can view your device's status and access applications.

The Home screen has multiple panels. Scroll left or right to view the panels on the Home screen. You can also select one of the dots at the top of the screen to move directly to the corresponding panel.

> System bar

From the system bar at the bottom of the screen, you can quickly navigate screen, view system information, and more.

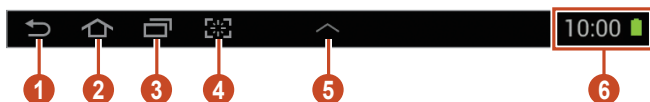









Number	Function
1	Return to the previous screen.
2	Return to the Home screen; Access the Google search widget or Google Now (tap and hold).
3	Open the list of recent applications.
4	Launch the application that you specified as the quick launch shortcut. You can change this quick launch shortcut by selecting Settings → Display → Quick launch .
5	Open the mini apps panel.
6	View the current time and your device's status; Open the notifications panel.

› Indicator icons



Icons shown on the display may vary depending on your region or service provider.

Icon	Definition
	Wi-Fi AP connected
	Bluetooth feature activated
	GPS-based services in use
	Connected to computer
	New message
	Alarm activated
	Flight mode activated
	Error occurred or caution required
	Battery power level

› Use the notifications panel

To open the notifications panel, tap the right bottom of the screen. To hide the panel, select .

From the notifications panel, you can view your device's current status and use the following options:

- **Wi-Fi:** Activate or deactivate the Wi-Fi feature. ▶ p. 84
- **GPS:** Activate or deactivate the GPS feature. ▶ p. 93
- **Sound:** Activate or deactivate Silent mode. You can mute your device or set it to vibrate in Silent mode.
- **Screen rotation:** Allow or prevent the interface from rotating when you rotate the device.
- **Power saving:** Activate or deactivate Power saving mode.
- **Blocking mode:** Activate or deactivate Blocking mode. In blocking mode, the device will block notifications. To select which notifications will be blocked, select **Settings** → **Blocking mode**.
- **Bluetooth:** Activate or deactivate the Bluetooth feature. ▶ p. 91
- **Sync:** Activate or deactivate auto-syncing of applications.



The options available may vary depending on your region or service provider.

› Move an item on the Home screen

Tap and hold an item, and then drag it to a new location.

You can add an item to a new folder or move it to a new panel. Tap and hold the item, and then drag it to **Create folder** or **Create page**.

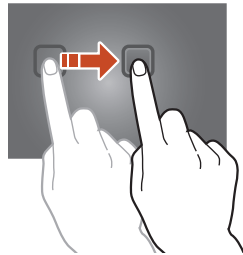

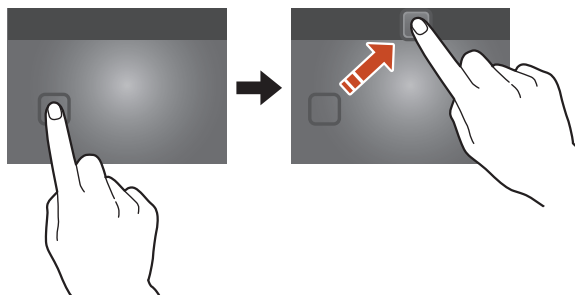

› Remove an item from the Home screen

Tap and hold an item, and then drag it to the rubbish bin.



› Add or remove a panel from the Home screen

You can add or remove Home screen panels to organise widgets.

- 1 On the Home screen, place two fingers on the screen and pinch them together to switch to Edit mode.
- 2 Add, remove, or reorganise panels:
 - To remove a panel, tap and hold the panel's thumbnail image, and then drag it to the rubbish bin.
 - To add a new panel, select .
 - To set the main panel of the Home screen, select .
 - To change the order of panels, tap and hold the panel's thumbnail image, and then drag it to a new location.
- 3 Select  to return to the previous screen.

› Use widgets

Widgets are small applications that provide convenient functions and information on your Home screen.





The widgets available may vary depending on your region or service provider.

- 1 In the application list, select **Widgets** to open the widget panel.
- 2 Scroll left or right on the widget panel to find a widget.
- 3 Tap and hold a widget to add it to the Home screen.

Access applications

Launch applications and take full advantage of features on your device. You can reorganise the application list to match your preferences, or download applications from the Internet to enhance your device's functionality.



- 1 On the Home screen, select  to access the application list.
- 2 Scroll left or right to another screen.
You can also select one of the dots at the bottom of the screen to move directly to the corresponding screen.
- 3 Select an application.
- 4 Select  to return to the previous screen. Select  to return to the Home screen.



- You can add an application shortcut to the Home screen by tapping and holding an icon in the application list.
- If you rotate the device while using some features, the interface will rotate as well. To prevent the interface from rotating, tap the right bottom of the screen to open the notifications panel, and then select **Screen rotation**.

› Organise applications



You can change the order of applications in the application list or group them into categories.

- 1 In the application list, select  → **Edit**.
 - 2 Tap and hold an application icon.
 - 3 Organise applications:
 - To move the application, drag it to a new location.
 - To add the application to a new folder, drag it to **Create folder**.
 - To move the application to a new panel, drag it to **Create page**.
 - To uninstall the application, drag it to **Uninstall**.
-  When you drag the application icon to **App info**, you can view information about the application.
- 4 Select **Save**.

› Download an application

- 1 In the application list, select **Play Store** or **Samsung Apps**.
 - 2 Search for an application and download it to the device.
-  To install applications that you downloaded from other sources, you must select **Settings** → **Security** → **Unknown sources**.

› Uninstall an application

- 1 In the application list, select  → **Uninstall**.
 - 2 Select  on an application icon and then select **OK**.
-  You can uninstall only the applications that you have downloaded.

› Access recently-used applications

- 1 Select  to view the applications you have accessed recently.
- 2 Select an application.

Launch multiple applications

Your device allows you to multitask by running multiple applications at the same time. To launch multiple applications, select  while using an application. Then select another application to launch from the Home screen.

› Manage applications

You can manage multiple applications with the task manager.

- 1 Select  → **Task manager** → **Active applications**.
The task manager launches and shows active applications.
- 2 Control active applications:
 - To switch applications, select one from the list.
 - To close an application, select **End**.
 - To close all active applications, select **End all**.

Customise your device

Get more from your device by changing settings to match your preferences.

› Change the display language

- 1 In the application list, select **Settings** → **Language and input** → **Language**.
- 2 Select a language.

› Turn on or off the touch tones

In the application list, select **Settings** → **Sound** → **Touch sounds**.

› Adjust the device's volume

- 1 Press the Volume key up or down.
- 2 Select  and drag the sliders to adjust the volume level for each sound.

› Switch to Silent mode

To mute or unmute your device, do one of the following:

- Tap the right bottom of the screen to open the notifications panel, and then select **Sound**.
- Press and hold the Power key, and then select .

› Select a wallpaper for the Home screen

- 1 On the Home screen, tap and hold the empty area.
- 2 Select **Set wallpaper** → **Home screen** → an image folder → an image.

› Change the display font

- 1 In the application list, select **Settings** → **Display** → **Font style**.
- 2 Select a font.

› Adjust the brightness of the display

Your device includes a light sensor, which can detect the level of ambient light and adjust the brightness of the display automatically. You can also manually set the brightness of the display.



The brightness of the display will affect how quickly the device consumes battery power.

Set your device to adjust the brightness automatically

- 1 In the application list, select **Settings** → **Display** → **Brightness**.
- 2 Select the tick box next to **Automatic brightness**.
- 3 Select **OK**.
The device will increase the brightness in bright surroundings and decrease the brightness in dim surroundings automatically.

Adjust the brightness manually

- 1 In the application list, select **Settings** → **Display** → **Brightness**.
- 2 Clear the tick box next to **Automatic brightness**.
- 3 Drag the slider to the left or right.
- 4 Select **OK**.

› Lock your device

You can lock your device by activating the screen lock feature.



- If you forget your password, take your device to a Samsung Service Centre to reset it.
- Samsung is not responsible for the loss of passwords or private information, or other damages caused by illegal software.

Set a face detection unlock

- 1 In the application list, select **Settings** → **Lock screen** → **Screen lock** → **Face unlock**.
- 2 Select **Next** → **Set it up** → **Continue**.
- 3 Adjust the device to fit your face inside the figure.
- 4 When your face is captured correctly, select **Continue**.
- 5 Complete the setup of the backup PIN or pattern.

Set an unlock pattern

- 1 In the application list, select **Settings** → **Lock screen** → **Screen lock** → **Pattern**.
- 2 View the on-screen instructions and the example pattern, and then select **Next**.
- 3 Draw a pattern to connect at least 4 dots and select **Continue**.
- 4 Draw the pattern again to confirm and select **Confirm**.
- 5 Complete the setup of the backup PIN.



- If you forget your unlock pattern, you can deactivate the screen lock feature with a backup PIN.

Set an unlock PIN

- 1 In the application list, select **Settings** → **Lock screen** → **Screen lock** → **PIN**.
- 2 Enter a new PIN and select **Continue**.
- 3 Enter the PIN again and select **OK**.

Set an unlock password

- 1 In the application list, select **Settings** → **Lock screen** → **Screen lock** → **Password**.
- 2 Enter a new password (alphanumeric) and select **Continue**.
- 3 Enter the password again and select **OK**.

▶ Activate the Find my mobile feature

When your device is lost or stolen, you can view the current location of your device on the SamsungDive website (www.samsungdive.com). To use this feature, you must create a Samsung account for controlling the device remotely via the Internet.

- 1 In the application list, select **Settings** → **Security** → **Remote controls** → **OK** → **Add account**.
- 2 Select **Sign in**.
To create a Samsung account, select **Create new account**.
- 3 Enter the email address and password for your Samsung account, and then select **Sign in**.
- 4 Drag the slide bar at the top of the screen.

Enter text

You can enter text by speaking words into the microphone, selecting characters on the virtual keypad, or by writing on the screen.

 Text entry is not supported in some languages. To enter text, you must change the input language to one of the supported languages.

› Change the text input method

Select  on the system bar and select a text input method.

› Enter text with the Google voice input feature

- 1 To add input languages for voice recognition, select the language → **Add more languages**.
- 2 Speak your text into the microphone.
- 3 When you are finished, select **Tap to pause**.

› Enter text with the Samsung keypad

Enter text by selecting alphanumeric keys or writing on the screen.

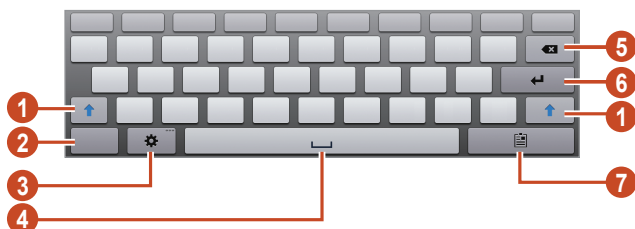

You can also use the following keys:



Number	Function
1	Change the case.
2	Switch text input modes.
3	Access the keypad settings; Tap and hold  to switch to Handwriting mode or enter text by voice.
4	Insert a space.
5	Clear your input.
6	Start a new line.
7	Add an item from the clipboard.

› Copy and paste text

From a text field, you can copy and paste text to another application.

- 1 Tap and hold a passage of text.
- 2 Drag  or  to select the text to be copied.
- 3 Select **Copy** or **Cut** to add the text to the clipboard.
- 4 In another application, place the cursor at the point where the text will be inserted.
- 5 Select **Paste** to insert the text from the clipboard into the text field.

Web and GPS-based services

Internet

Learn to access and bookmark your favourite webpages.



- This feature may be labelled differently depending on your region or service provider.
- Available icons may vary depending on your region or service provider.

› Browse a webpage









- 1 In the application list, select **Internet**.
- 2 To access a specific webpage, select the URL field, enter the web address, and then select **Go**.
- 3 Navigate webpages with the following keys:





Number	Function
1	Open a new window.
2	Close the current window.
3	Move backwards or forwards to webpages in history.

Number	Function
4	Reload the current webpage. While the device is loading webpages, this icon changes to  .
5	Enter a web address or a keyword.
6	Access web browser options.
7	View your bookmarks, saved pages, and recent Internet history.
8	Activate the URL field.
9	Bookmark the current webpage.

While browsing a webpage, access the following options:

- To zoom in or out, place two fingers on the screen and slowly spread them apart or pinch them together. To return to the original size, double-tap the screen.
- To open a new window, select  → **New tab**.
- To open a new window without saving your browsing data, select  → **New incognito tab**.
- To add a shortcut for the current webpage to the Home screen, select  → **Add shortcut to home**.
- To send a web address to others, select  → **Share page**.
- To search for text on a webpage, select  → **Find on page**.
- To switch to the desktop view, select  → **Desktop view**.
- To save the current webpage for reading offline, select  → **Save for offline reading**. You can view the saved pages by selecting  → **Saved pages**.

- To view your download history, select  → **Downloads**.
- To print the webpage via Wi-Fi or USB, select  → **Print**.
Your device is compatible only with some Samsung printers.
- To change the browser settings, select  → **Settings**.

▶ Search for information by voice





This feature may be unavailable depending on your region or service provider.

- 1 In the application list, select **Internet**.
- 2 Select the URL field.
- 3 Select  and say a keyword into your device's microphone.
The device searches for webpages related to the keyword.
- 4 Select a search result.

▶ Bookmark your favourite webpage

If you know the address of a webpage, you can add a bookmark manually.

- 1 In the application list, select **Internet**.
- 2 Enter a web address or navigate to a webpage.
- 3 Select .
- 4 Enter a name for the bookmark and select **OK**.

To view your bookmarks, select  → **Bookmarks**. From the bookmark list, tap and hold a bookmark to access the following options:

- To open the webpage in the current window, select **Open**.
- To open a new window, select **Open in new tab**.
- To edit bookmark details, select **Edit bookmark**.
- To add the bookmark shortcut to the Home screen, select **Add shortcut to home**.
- To send the address of the current webpage to others, select **Share link**.
- To copy the address of the current webpage, select **Copy link URL**.
- To delete the bookmark, select **Delete bookmark**.
- To set the webpage as your browser's homepage, select **Set as homepage**.

► Download a file from the Internet

When you download files or applications from the Internet, your device saves them to the internal memory.

 Files you download from the Internet can include viruses that will damage your device. To reduce this risk, only download files from sources you trust.

 Some media files include Digital Rights Management to protect copyrights. This protection may prevent you from downloading, copying, modifying, or transferring some files.

- 1 In the application list, select **Internet**.
- 2 Search for a file or application and download it to the device.

› View your recent history

- 1 In the application list, select **Internet** →  → **History**.
- 2 Select a webpage to access.

Game Hub

Learn to access and download games.

- 1 In the application list, select **Game Hub**.
- 2 Select a game service.
- 3 Search for and download games from the online store.



The games available may vary depending on your region or service provider.



Maps

Learn to use the Google Maps™ mapping service to find your location, search for places, and get directions.











- This feature may be unavailable depending on your region or service provider.
- You must activate location services to find your location and search the map. ► p. 93



› Search for a location

- 1 In the application list, select **Maps**.
The map will show your current location.
- 2 Select **Search Maps**.
- 3 Enter a keyword for the location and select .
- To search for a location by voice, select .
- 4 Select the location to view its details.

While viewing the map, use the following options:

- To zoom in or out, place two fingers on the screen and slowly spread them apart or pinch them together.
- To view all of the search results, select **Search Results**.
- To view your current location, select . To switch to the compass view of the map that changes orientation when you move the device, select .
- To search for a place nearby, select .
- To get directions to a specific destination, select .
- To add layers of additional information to the map or change the view mode, select .
- To add a star to the location, select the balloon with the location name, select  or  → **Add star**.
- To save a map and for offline viewing, select  → **Make available offline**. To view the saved map, select  → **My Places** → **OFFLINE**.

▶ Get directions to a specific destination

- 1 In the application list, select **Maps**.
- 2 Select .
- 3 Enter the addresses of the starting location and the destination.
To enter an address from your contact list or starred places, or select a point on the map, select  → an option.
- 4 Select a travel method and select **Go**.
The route is indicated on the map. Depending on the selected travel method, you may see multiple routes.
- 5 When you are finished, select  → **Clear Map**.

Navigation

Learn to get spoken directions to your destination.



- Navigation maps, your current location, and other navigational data may differ from actual location information. You should always pay attention to road conditions, traffic, and any other factors that may affect your driving and follow all safety warnings and regulations while driving.
- This feature may be unavailable depending on your region or service provider.

1 In the application list, select **Navigation**.

2 Enter your destination with the following methods:

- **Speak destination:** Enter your destination by voice.
- **Type destination:** Enter your destination with the virtual keypad.
- **Contacts:** Select your destination from contacts' addresses.
- **Starred places:** Select your destination from your starred places.



3 Install the required software, and then use the navigation features.

Local

Learn to search for business and attractions.



- This feature may be unavailable depending on your region or service provider.

- 1 In the application list, select **Local**.
 - 2 If you want to search for businesses or attractions near a specific location, select your location → **Enter an address**.
 - 3 Select a category.
The device searches for places nearby that are related to the category.
 - 4 Select a place name to view its details.
-  You can add more categories by selecting  → **Add a search**.

Play Store

Your device's functionality can be extended by installing additional applications. Play Store provides a quick and easy way to shop for mobile applications.

-  • This feature may be unavailable depending on your region or service provider.
- Your device will save user files from downloaded applications to the internal memory.

› Download an application

- 1 In the application list, select **Play Store**.
- 2 Search for an application and download it to the device.
When the download is complete, the device will install the application automatically.

› Uninstall an application

- 1 In the application list, select **Play Store**.
- 2 Select .
- 3 Select an item.
- 4 Select **Uninstall** → **OK**.

Readers Hub

Learn to access various reading materials.

- 1 In the application list, select **Readers Hub**.
- 2 Select a type of reading material.
- 3 Search for and download reading material from the online store.

Samsung Apps

Samsung Apps allows you to easily download a wide range of applications and updates for your device. With fully optimised applications from Samsung Apps, your device becomes even smarter. Explore the useful applications on offer and enhance your mobile life.

- 1 In the application list, select **Samsung Apps**.
- 2 Search for and download applications to the device.



- This feature may be unavailable depending on your region or service provider.
- For details, please visit www.samsungapps.com or refer to the Samsung Apps leaflet.

S Suggest

Find and download the latest applications suggested by Samsung. In the application list, select **S Suggest**.



This feature may be unavailable depending on your region or service provider.

YouTube

Learn to view and upload videos via the YouTube™ video sharing service.



This feature may be unavailable depending on your region or service provider.

> Play a video

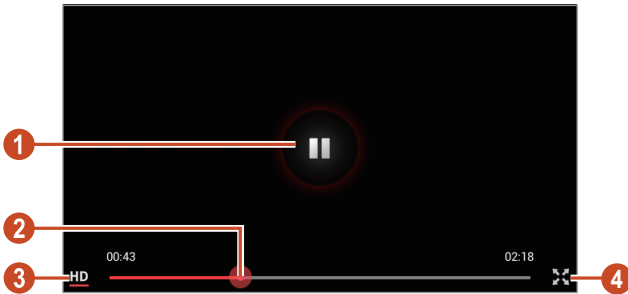

- 1 In the application list, select **YouTube**.
- 2 Select a video.
- 3 Control playback with the following keys:



Number	Function
1	Pause or resume playback.
2	Scan forwards or backwards in the file by dragging the bar.

Number	Function
3	Change the quality of the display.
4	Play the video on the full screen.

› Upload a video

- 1 In the application list, select **YouTube**.
- 2 Select your Google account if it is linked to YouTube.
Alternatively, you can select **Sign in** and set up an account to sign in to YouTube.
- 3 Select  → a category → a video.
 If you are uploading a video for the first time, select a network type to upload a video.
- 4 Enter the details of the upload and select **UPLOAD**.

Voice Search

Learn to search the Internet by voice.

-  This feature may be unavailable depending on your region or service provider.

- 1 In the application list, select **Voice Search**.
- 2 Say a keyword into the microphone.
The device searches for webpages related to the keyword.
- 3 Select a search result.

Communication



Google Mail

Learn to send or view email messages via the Google Mail™ webmail service.



- This feature may be unavailable depending on your region or service provider.
- This feature may be labelled differently depending on your region or service provider.

› Send an email message

- 1 In the application list, select **Google Mail** → .
- 2 Select the recipient field and enter an email address.
- 3 Select the subject field and enter a subject.
- 4 Select the text field and enter your email text.
- 5 Select  and attach a file.
- 6 To send the message, select **SEND**.

















If you are offline, the message will be held in the message thread until you are online.

› View an email message

- 1 In the application list, select **Google Mail**.
- 2 Select  to update the message list.
- 3 Select an email message.

From the message view, use the following options:

- To move to the next or previous message, scroll right or left.
- To reply to the message, select .
- To reply to the message and include all recipients, select .
- To forward the message to others, select .
- To add the message to the favourites list, select .
- To view an attachment, select **VIEW**. To save it to your device, select **SAVE**.
- To search for a message, select .
- To archive the message, select .
- To delete the message, select .
- To add a label to the message, select  → **Change labels**.
- To mark the message as unread, select  → **Mark unread**.
- To mark the message as important, select  → **Mark as important**.
- To hide the message, select  → **Mute**. To view hidden messages, select **All mail** from the label list.
- To add the message to the spam list, select  → **Report spam**.
- To report the message to Google as a phishing attack, select **Report phishing**.
- To update the message list, select  → **Refresh**.
- To customise the settings for each label, select  → **Manage labels**.
- To change the email settings, select  → **Settings**.



The options available may vary depending on the email account or device's orientation.

Email



Learn to send or view email messages via your personal or company email account.

› Set up an email account

- 1 In the application list, select **Email**.
- 2 Enter your email address and password.
- 3 Select **Next**. To enter account details manually, select **Manual setup**.
- 4 Follow the on-screen instructions.

When you are finished setting up the email account, email messages will be downloaded to your device. If you have created two or more accounts, you can switch between them. Select an account name at the top of the screen, and then select the account from which you want to retrieve messages.

› Send an email message

- 1 In the application list, select **Email** → .
- 2 Add recipients:
 - Enter email addresses manually and separate them with a semicolon or a comma.
 - Select email addresses from your contact list by selecting .
- 3 Select the subject field and enter a subject.
- 4 Select the text field and enter your email text.

5 Select  and attach a file.

6 To send the message, select **Send**.



If you are offline, the message will be held in the message thread until you are online.









> View an email message





1 In the application list, select **Email**.

2 Select  to update the message list.

3 Select an email message.

From the message view, use the following options:

- To reply to the message, select .
- To forward the message to others, select .
- To delete the message, select .
- To mark the message as unread, select  → **Mark as unread**.
- To move the message to another folder, select  → **Move**.
- To save the message to your device, select  → **Save email**. The message will be saved in **My Files** → **Device** → **Saved Email**.
- To sort messages, select  → **Sort by**.
- To change the view mode of the message list, select  → **View mode**.
- To print the message via Wi-Fi or USB, select  → **Print**. Your device is compatible only with some Samsung printers.

- To save the email addresses of the recipients to the phonebook as a group of contacts, select  → **Save as group**.
- To delete all messages, select  → **Delete all**.
- To change the email settings, select  → **Settings**.
- To save an attachment to your device, select the attachment tab → .



The options available may vary depending on the email account or device's orientation.

Talk

Learn to send and receive instant messages to friends and family with the Google Talk™ instant messaging service.



This feature may be unavailable depending on your region or service provider.





› Set your status

- 1 In the application list, select **Talk**.
- 2 Select a Google account.
- 3 Customise your status, image, and message.

› Add a contact to your friend list

- 1 In the application list, select **Talk** → .
- 2 Enter a friend's email address, and then select **DONE**.
When your friend accepts the invitation, he or she is added to your friend list.

› Start a conversation

- 1 In the application list, select **Talk**.
- 2 Select a contact from the friend list.
The conversation screen opens.
- 3 Enter and send your message.
 - To add more contacts to the conversation, select  → **Add to chat**.
 - To use video chat, select .
 - To use voice chat, select .
- 4 Select  → **End chat** to end the conversation.

ChatON

Learn to use ChatON to send and receive instant messages from any device that has a mobile phone number.

- 1 In the application list, select **ChatON**.
 -  If you are launching this application for the first time, follow the on-screen instructions to complete the account setup.
- 2 Enter and send your message.

Messenger

Learn to send and receive instant messages from friends and family with the Google+ messenger instant messaging service.

1 In the application list, select **Messenger**.



If you are launching this application for the first time, follow the on-screen instructions to complete the account setup.

2 Enter and send your message.

Google+

Learn to access Google's social network service. You can create groups to send and receive instant messages and upload your photos.

1 In the application list, select **Google+**.



If you are launching this application for the first time, follow the on-screen instructions to complete the account setup.

2 Select  → a social network feature.

Entertainment

Camera

Learn how to take and view photos and videos.







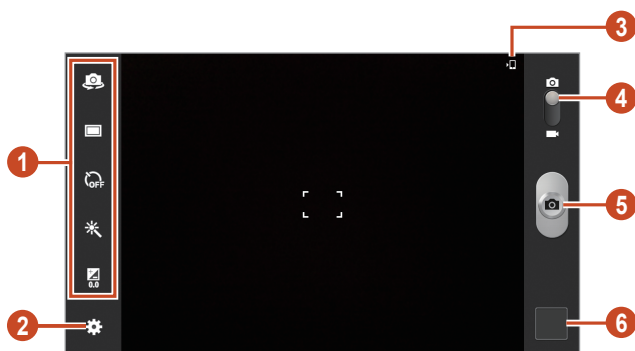

- The camera turns off automatically when you do not use it for a specified period.
- The memory capacity may differ depending on the scene or shooting conditions.

› Take a photo

- 1 In the application list, select **Camera**.
- 2 Aim the camera lens at the subject and make any necessary adjustments.

















Number	Function
1	<p>Use camera shortcuts.</p> <ul style="list-style-type: none"> • : Switch to the front camera to take a photo of yourself. • : Change the shooting mode. <ul style="list-style-type: none"> ▶ p. 59 • : Select the length of the delay before the camera takes a photo. • : Apply a special effect. • : Adjust the exposure value to change the brightness. <p>You can add or remove shortcuts to frequently-used options. ▶ p. 64</p>
2	Change the camera settings.
3	View the storage location.
4	Switch to the camcorder.
5	Take a photo.
6	View photos you have taken.

3 Select  to take a photo.

The photo is saved automatically.

After taking a photo, select the image viewer to view it.

- To view more photos, scroll left or right.
- To zoom in or out, place two fingers on the screen and slowly spread them apart or pinch them together. To return to the original size, double-tap the screen.
- To add the photo to the favourites list, select .
- To send the photo to others, select .

- To delete the photo, select .
- To start a slide show, select  → **Slideshow** → **Start slideshow**. Tap the screen to stop the slide show.
- To change the settings for a slide show, select  → **Slideshow** → **Slideshow settings**.
- To register the faces in the photo as face tags, select  → **Face tag**. ► p. 68
- To add the photo to the clipboard, select  → **Copy to clipboard**.
- To rotate the photo anti-clockwise, select  → **Rotate left**.
- To rotate the photo clockwise, select  → **Rotate right**.
- To crop a section from the image, select  → **Crop**.
- To edit the photo with the image editor, select  → **Edit**.
► p. 70
- To set the photo as your wallpaper or a contact image, select  → **Set as**.
- To send the photo to a person whose face is tagged in the photo, select  → **Buddy photo share**.
- To print the photo via Wi-Fi or USB, select  → **Print**. Your device is compatible only with some Samsung printers.
- To change the name of a file, select  → **Rename**.
- To search for devices that have media sharing activated, select  → **Scan for nearby devices**.
- To view photo details, select  → **Details**.

› Change the shooting mode

You can take photos with various shooting modes. To change the shooting mode, select  → **Shooting mode** → an option.

Option	Function
Panorama	Take panoramic photos.
Share shot	Take a photo and send it to others via Wi-Fi Direct.
Buddy photo share	Set the device to recognise a person's face you have tagged in a photo and send it to that person.
Smile shot	Set the device to recognise people's faces and help you take photos of them when they smile.

› Customise camera settings

Before taking a photo, select  to access the following options:

Option	Function
Edit shortcuts	Edit shortcuts to frequently-used options.
Self portrait	Take photos of yourself with the front camera.
Shooting mode	Change the shooting mode. ► p. 59
Effects	Apply a special effect.
Scene mode	Change the scene mode.

Option	Function
Exposure value	Adjust the exposure value to change the brightness.
Timer	Select the length of the delay before the camera takes a photo.
Resolution	Select a resolution option.
White balance	Adjust the colour balance according to the lighting conditions.
Metering	Select a type of exposure metering.
Guidelines	Set to view the grid lines on the preview screen.
GPS tag	<p>Set the camera to include location information for your photos.</p>  <ul style="list-style-type: none"> • To improve GPS reception, avoid shooting in locations where the signal may be obstructed, such as between buildings or in low-lying areas, or in poor weather conditions. • Your location may appear on your photos when you upload them to the Internet. To avoid this, deactivate the GPS tag setting.
Image quality	Select a quality level for your photos.
Storage	Select a memory location for saving captured photos.
Reset	Reset camera settings.

Record a video

- 1 In the application list, select **Camera**.
- 2 Drag the slider to switch to the camcorder.
- 3 Aim the lens at the subject and make any necessary adjustments.



Number	Function
1	<p>Use camcorder shortcuts.</p> <ul style="list-style-type: none">• : Switch to the front camera to record a video of yourself.• : Change the recording mode (for attaching to a message or for saving normally).• : Select the length of the delay before the camcorder records a video.• : Apply a special effect.• : Adjust the exposure value to change the brightness. <p>You can add or remove shortcuts to frequently-used options. ► p. 64</p>
2	<p>Change the camcorder settings.</p>

Number	Function
3	View the storage location.
4	Switch to the camera.
5	Record a video.
6	View videos you have recorded.









4 Select  to start recording.

5 Select  to stop recording.

The video is saved automatically.

 The camcorder may not be able to properly record videos on memory cards with slow transfer speeds.

After recording a video, select the image viewer to view it.

- To view more videos, scroll left or right.
- To play the video, select .
- To add the video to the favourites list, select .
- To send the video to others, select .
- To delete the video, select .
- To start a slide show, select  → **Slideshow** → **Start slideshow**. Tap the screen to stop the slide show.
- To change the settings for a slide show, select  → **Slideshow** → **Slideshow settings**.
- To change the name of a file, select  → **Rename**.
- To search for devices that have media sharing activated, select  → **Scan for nearby devices**.
- To view video details, select  → **Details**.

› Customise camcorder settings

Before recording a video, select  to access the following options:

Option	Function
Edit shortcuts	Edit shortcuts to frequently-used options.
Self recording	Switch to the front camera to record a video of yourself.
Recording mode	Change the recording mode (for attaching to a message or for saving normally).
Effects	Apply a special effect.
Exposure value	Adjust the exposure value to change the brightness.
Timer	Select the length of the delay before the camcorder starts recording a video.
Resolution	Select a resolution option.
White balance	Adjust the colour balance according to the lighting conditions.
Guidelines	Set to view the grid lines on the preview screen.
Video quality	Select a quality level for your videos.
Storage	Select a memory location for saving recorded videos.
Reset	Reset camcorder settings.

› Edit the shortcut icons

You can add or remove shortcuts to frequently-used options.

- 1 From the preview screen, select  → **Edit shortcuts**.
- 2 Tap and hold an icon from the option list, and then drag it to the shortcut area.
To remove shortcuts, tap and hold an icon, and then drag it to the option list.
- 3 Tap the screen to return to the preview screen.

Video Player

Learn to use the video player.



- Some file formats are not supported depending on the device's software.
- If a file size exceeds the memory available, an error may occur when you try to open the file.
- Playback quality may vary by content type.
- Some files may not play properly depending on how they are encoded.

› Play a video

- 1 In the application list, select **Video Player**.
- 2 Select a video.

3 Control playback with the following keys:

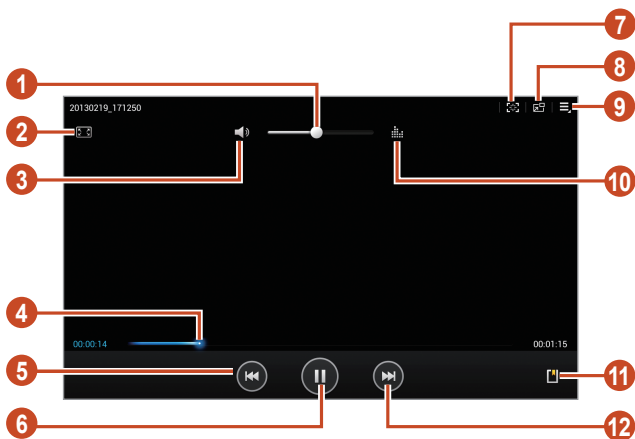

Number	Function
1	Adjust the volume.
2	Change the ratio of the video screen.
3	Mute the sound.
4	Scan forwards or backwards in the file by dragging or tapping the bar.
5	Restart playback; Skip to the previous file (tap within 3 seconds); Scan backwards in the file (tap and hold).
6	Pause playback; Select ▶ to resume playback.
7	Capture a screenshot.

Number	Function
8	Reduce the size of the video screen. To return to the original size, double-tap the video screen.
9	Access video player options.
10	Select a sound effect.
11	Insert a bookmark.
12	Skip to the next file; Scan forwards in the file (tap and hold).

During playback, select  to access the following options:

- To send the video to others, select **Share via**.
- To trim a segment of the video, select **Trim**.
- To listen to audio via a Bluetooth headset, select **Via Bluetooth**. You cannot use this option if you connect a headset to your device's headset jack.
- To edit the video with the video editor, select **Video editor**.
- To view your bookmarks, select **Bookmarks**. This option appears if you have inserted a bookmark during playback.
- To view video details, select **Details**.
- To set the video player to turn off automatically after a specific period of time, select **Time set for auto video off**.
- To search for devices that have media sharing activated, select **Scan for nearby devices**.
- To change the video player settings, select **Settings**.

Gallery

Learn to view images and play videos saved in your device.







- Some file formats are not supported depending on the device's software.
- If a file size exceeds the memory available, an error may occur when you try to open the file.
- Playback quality may vary by content type.
- Some files may not play properly depending on how they are encoded.











› View an image

1 In the application list, select **Gallery**.

2 Select a folder → an image.

While viewing an image, use the following options:

- To view more images, scroll left or right.
- To zoom in or out, place two fingers on the screen and slowly spread them apart or pinch them together. To return to the original size, double-tap the screen.
- To add the image to the favourites list, select .
- To send the image to others, select .
- To delete the image, select .
- To start a slide show, select  → **Slideshow** → **Start slideshow**. Tap the screen to stop the slide show.
- To change the settings for a slide show, select  → **Slideshow** → **Slideshow settings**.
- To register the faces in the image as face tags, select  → **Face tag**. ► p. 68
- To add the image to the clipboard, select  → **Copy to clipboard**.

- To rotate the image anti-clockwise, select  → **Rotate left**.
- To rotate the image clockwise, select  → **Rotate right**.
- To crop a section from the image, select  → **Crop**.
- To edit the image with the image editor, select  → **Edit**.
▶ p. 70
- To set the image as your wallpaper or a contact image, select  → **Set as**.
- To send the image to a person whose face is tagged in the photo, select  → **Buddy photo share**.
- To print the image via Wi-Fi or USB, select  → **Print**. Your device is compatible only with some Samsung printers.
- To change the name of a file, select  → **Rename**.
- To search for devices that have media sharing activated, select  → **Scan for nearby devices**.
- To view image details, select  → **Details**.



The options available may vary depending on the selected folder.

› Tag a face in an image

Learn to tag faces in your images to upload messages to social networks with the face tag shortcuts.





Face recognition may fail depending on face angle, face size, skin colour, facial expression, light conditions, or accessories the subject is wearing.

- 1 In the application list, select **Gallery**.
- 2 Select an image.

- 3 Select  → **Face tag** → **On**.
Recognised faces appear in the frame. If faces are not recognised automatically, tap and hold a face area to add a frame manually.
- 4 Select a recognised face → **Add name**.
- 5 Select the person's name from the contact list.
The contact is linked to the face in the image. When the face tag appears with a name, select the face tag and use the available options.

▶ Play a video



- 1 In the application list, select **Gallery**.
- 2 Select a folder → a video (indicated by the  icon).
- 3 Select  to begin playback.
- 4 Control playback with the keys. ▶ p. 65



During playback, select  to access the following options:

- To send the video to others, select **Share via**.
- To trim a segment of the video, select **Trim**.
- To listen to audio via a Bluetooth headset, select **Via Bluetooth**. You cannot use this option if you connect a headset to your device's headset jack.
- To edit the video with the video editor, select **Video editor**.
- To view your bookmarks, select **Bookmarks**. This option appears if you have inserted a bookmark during playback.
- To view video details, select **Details**.
- To search for devices that have media sharing activated, select **Scan for nearby devices**.
- To change the video player settings, select **Settings**.

Photo Editor

You can edit images and apply various effects.

- 1 In the application list, select **Photo Editor**.
- 2 Select an image, or select **Select picture** → a folder → an image.
To take a new photo, select **Take picture**.
- 3 Select **Selection** → **OK**.
- 4 Draw a border around the area you want to select, and then select **Done**.
 - To change the type of selection tool, select **Selection**.
 - To edit the selection border, select , , or . If you select **Magnetic** or **Brush**, you can adjust the border size by selecting **Selection size**.
 - To reverse the selection, select **Inverse**.
- 5 Edit the image with the following tools:

Tool	Function
Rotate	Rotate or flip the image.
Resize	Resize the image by dragging the rectangle or selecting 100% → an option.
Crop	Crop the image by moving or dragging the rectangle.
Colour	Apply a colour effect.
Effect	Apply a filter effect.
Tools	Use additional tools.
	Undo your last action.
	Redo your last action.

- 6 When you are finished, select .
- 7 Enter a name for the image and select **OK**.

Video Editor

You can edit videos and apply various effects.

› Create a video

- 1 In the application list, select **Video Editor**.
- 2 Select a frame theme.
- 3 Select **Add media**.
- 4 Select a category in the left panel and then select images, videos, and audios to make video, and then **Done**.
 - To set the length of time that an image appears, select the thumbnail, and then drag the left or right border of the thumbnail.
 - To delete images or videos, tap and hold an item, and then drag it to the rubbish bin.
 - To rearrange images or videos, tap and hold an item, and then drag it to a new location.
- 5 Select a transition effect icon between images or videos and select an effect.
- 6 When you are finished, select  → **Export**.
- 7 Select a resolution option.
- 8 Enter a name for the video and select **OK**.

› Trim a segment of a video

- 1 Launch the video editor and open a video file.
- 2 Select the thumbnail.
- 3 Move the start bracket to the point where trimming should begin.
- 4 Move the end bracket to the point where the trimming should end.
- 5 Save the edited video.

› Split a video

- 1 Launch the video editor and open a video file.
- 2 Select the thumbnail.
- 3 Drag the thumbnail at the bottom of the screen to place the yellow line.
- 4 Select .
- 5 Save the edited video.

› Apply an effect to a video

- 1 Launch the video editor and open a video file.
- 2 Drag the thumbnail at the bottom of the screen to place the yellow line.
- 3 Select **Effect** → an effect option.
- 4 Save the edited video.

Music Player

Learn to listen to your favourite music while on the go.



- Some file formats are not supported depending on the device's software.
- If a file size exceeds the memory available, an error may occur when you try to open the file.
- Playback quality may vary by content type.
- Some files may not play properly depending on how they are encoded.

› Add music files to your device

Start by transferring files to your device or memory card:

- Download from the Internet. ► p. 38
- Download from a computer with Samsung Kies. ► p. 82
- Download from a computer with Windows Media Player. ► p. 83
- Receive via Bluetooth. ► p. 93

› Play music

- 1 In the application list, select **Music Player**.
- 2 Select a music category → a music file.
- 3 Select the album image to open the music player screen.

4 Control playback with the following keys:



Number	Function
1	Adjust the volume.
2	Set the file as your favourite track.
3	Mute the sound.
4	Scan forwards or backwards in the file by dragging or tapping the bar.
5	Activate Shuffle mode.
6	Restart playback; Skip to the previous file (tap within 3 seconds); Scan backwards in the file (tap and hold).
7	Pause playback; Select ▶ to resume playback.
8	View music details.
9	Open the playlist.
10	Access music options.

Number	Function
11	Select a sound effect.
12	Change the repeat mode.
13	Skip to the next file; Scan forwards in the file (tap and hold).



You can control the music player with a headset. On the Home screen, press and hold the headset button to launch the music player. Then, press the headset button to start or pause playback.

During playback, select to access the following options:

- To add the music file to a playlist, select **Add to playlist**.
- To listen to music via a Bluetooth headset, select **Via Bluetooth**. You cannot use this option if you connect a headset to your device's headset jack.
- To send the music file to others, select **Share via**.
- To set the music file as your alarm tone, select **Set as alarm tone**.
- To search for devices that have media sharing activated, select **Scan for nearby devices**.
- To change the music player settings, select **Settings**.

› Create a playlist

- 1 In the application list, select **Music Player**.
- 2 Select → **New playlist**.
- 3 Enter a title for your new playlist and select **OK**.
- 4 Select a music category.
- 5 Select the files to include and select **Done**.

› Customise music player settings

- 1 In the application list, select **Music Player**.
- 2 Select  → **Settings**.
- 3 Change the following options:

Option	Function
Advanced → SoundAlive	Select a sound effect.
Advanced → Play speed	Change the playback speed.
Advanced → Lyrics	Set to show song lyrics during playback.
Advanced → Music auto off	Set the music player to turn off automatically after a specific period of time.
Music menu	Select music categories to show in the music library.

Music Hub

You can access the online music store to search for and buy your favourite songs. You can also add music files to your wish list and play them.

 This feature may be unavailable depending on your region or service provider.

- 1 In the application list, select **Music Hub**.
- 2 Search for, preview, or buy your favourite songs.

Personal information

Contacts

Learn to create and manage a list of your personal or business contacts. You can save names, phone numbers, email addresses, and more for your contacts.



› Create a contact

- 1 In the application list, select **Contacts** → **Contacts** → .
- 2 Select a memory location (if necessary).
- 3 Enter contact information.
- 4 Select **Save** to add the contact to memory.

› Find a contact

- 1 In the application list, select **Contacts** → **Contacts**.
- 2 Scroll up or down the contact list.
- 3 Select a contact's name.

From the contact view, use the following options:

- To send an email message, select .
- To set a favourite number, select .
- To edit the contact information, select .

› Create your namecard

- 1 In the application list, select **Contacts** → **Contacts**.
- 2 Select your name at the top of the contact list.
- 3 Select .
- 4 Enter your personal details and select **Save**.

 You can send your namecard to others by selecting  → **Share namecard via**.

› Create a group of contacts

By creating groups of contacts, you can manage multiple contacts and send a message to an entire group.

- 1 In the application list, select **Contacts** → **Groups** → .
- 2 Enter a name and customise the settings for the group.
- 3 Add members to the group.
- 4 Select **Save**.

› Import or export a contact

You can import or export files (in vcf format) to or from your device's USB storage or a memory card.

Import contact files

- 1 In the application list, select **Contacts** → **Contacts**.
- 2 Select  → **Import/Export** → **Import from SD card** or **Import from USB storage**.
- 3 Select a memory location (if necessary).

- 4 Select an option for importing a single contact file, multiple contact files, or all contact files, and then select **OK**.
- 5 Select contact files to import, and then select **OK**.

Export contacts

- 1 In the application list, select **Contacts** → **Contacts**.
- 2 Select  → **Import/Export** → **Export to SD card** or **Export to USB storage**.
- 3 Select **OK** to confirm.

S Planner

Your device includes a powerful planner to help you organise your schedules more conveniently and effectively. Learn to create and manage events and tasks, and set alarms to remind yourself of important events and tasks.

› Create an event or task

- 1 In the application list, select **S Planner**.
- 2 Select .
- 3 Select an event type at the top of the screen.
- 4 Enter the details of the event and select **Save**.

› Change the view mode

- 1 In the application list, select **S Planner**.
- 2 Select a view mode.
 - **Year**: All months in the year
 - **Month**: A full month in one view

- **Week:** Hourly blocks for the days in one full week
- **Day:** Hourly blocks for one full day
- **List:** A list of all the events and holidays scheduled for a specific period
- **Task:** A list of tasks



You can also change the view mode by placing two fingers on the screen and spreading them apart or pinching them together.

› View an event or task



1 In the application list, select **S Planner**.

2 Select a date on the calendar.

- To move to a specific day, select  → **Go to** and enter the date.
- To move to today's date, select **Today**.

3 Select an event to view its details.



You can send the event to others by selecting  → **Share via** or selecting  → .

› Stop an event or task alarm

If you set a reminder for a calendar event or task, an alarm will sound at the specified time.

1 Tap the right bottom of the system bar to open the notifications panel.

2 Select the event notification.

3 Select an event to view more details.

To snooze the event alarm, select **Snooze**.

Memo

Learn to record important information for viewing at a later date.















› Create a memo

- 1 In the application list, select **Memo**.
- 2 Select .
- 3 Enter your memo text.
- 4 Select **Done**.

› View a memo

- 1 In the application list, select **Memo**.
- 2 Select a memo to view its details.

While viewing the memo, use the following options:

- To delete the memo, select   .
- To change the background colour, select   .
- To protect the memo from accidental deletion, select   .
- To print the memo via Wi-Fi or USB, select   . Your device is compatible only with some Samsung printers.
- To send the memo to others, select   .

Connectivity

USB connections

Learn to connect your device to a computer with a USB cable.

 Do not disconnect the USB cable from a computer while the device is transferring or accessing data. Doing so may result in data loss or damage to the device.

 For best results, connect the USB cable directly to a USB port on a computer. Data transfers may fail when using a USB hub.

› Connect with Samsung Kies

Ensure that Samsung Kies is installed on your computer. You can download the program from the Samsung website.

 Samsung Kies will work on both Windows and Macintosh computers.

- 1 Connect your device to a computer with a USB cable. Samsung Kies launches on the computer automatically. If Samsung Kies does not launch, double-click the Samsung Kies icon on the computer.
- 2 Transfer files between your device and the computer. Refer to the Samsung Kies help for more information.

› Connect with Windows Media Player

Ensure that Windows Media Player is installed on your computer.

- 1 Connect your device to a computer with a USB cable.
- 2 Open Windows Media Player and synchronise music files.

› Connect as a media device

You can connect your device to a computer and access media files stored on your device.

- 1 Connect your device to a computer with a USB cable.
- 2 Tap the right bottom of the screen to open the notifications panel.
- 3 Select **Connected as a media device** → **Media device (MTP)**.
- 4 Transfer files between your device and the computer.

› Connect as a camera device

You can connect your device to a computer as a camera and access files in your device.



Use this USB connection mode when your computer does not support the media transfer protocol (MTP) or does not have the USB driver for your device installed.

- 1 Connect your device to a computer with a USB cable.
- 2 Tap the right bottom of the screen to open the notifications panel.
- 3 Select **Connected as a media device** → **Camera (PTP)**.
- 4 Transfer files between your device and the computer.

Wi-Fi

Learn to use your device's wireless networking capabilities to activate and connect to any wireless local area network (WLAN) compatible with the IEEE 802.11 standards.

You can connect to the Internet or other network devices anywhere an access point or wireless hotspot is available.



Your device uses a non-harmonised frequency and is intended for use in all European countries. The WLAN can be operated in the EU without restriction indoors, but cannot be operated outdoors.

› Activate the Wi-Fi feature

In the application list, select **Settings** and then drag the **Wi-Fi** switch to the right.



The Wi-Fi feature running in the background will consume battery power. To preserve battery power, activate the feature only when needed.

› Find and connect to a Wi-Fi AP

- 1 In the application list, select **Settings** → **Wi-Fi**.
Your device searches for available Wi-Fi APs automatically.
- 2 Select an AP.
- 3 Enter the password for the AP (if necessary).
- 4 Select **Connect**.

➤ Add a Wi-Fi AP manually

- 1 In the application list, select **Settings** → **Wi-Fi** → **Add Wi-Fi network**.
- 2 Enter an SSID for the AP and select a security type.
- 3 Set the security settings according to the security type you selected, and then select **Save**.

➤ Connect to a Wi-Fi AP with a protected setup

You can connect to a secured AP with a WPS button or WPS PIN. To use this method, your wireless access point must have a WPS button.

Connect with a WPS button

- 1 In the application list, select **Settings** → **Wi-Fi**.
- 2 Select  → **WPS push button**.
- 3 Press the WPS button on the AP within 2 minutes.

Connect with a WPS PIN

- 1 In the application list, select **Settings** → **Wi-Fi**.
- 2 Select  → **WPS PIN entry**.
- 3 On the AP, enter the PIN of your device.

› Set the static IP settings

- 1 In the application list, select **Settings** → **Wi-Fi**.
- 2 Select an AP → **Show advanced options**.
- 3 Select the **IP settings** drop-down menu.
- 4 Select **Static**.
- 5 Change the IP settings.
- 6 Select **Connect**.

› Customise Wi-Fi settings

- 1 In the application list, select **Settings** → **Wi-Fi** →  → **Advanced**.
- 2 Change the following options:

Option	Function
Network notification	Set the device to notify you when an open Wi-Fi AP is available.
Keep Wi-Fi on during sleep	Set whether or not to keep the Wi-Fi feature active in Sleep mode.
MAC address	View the MAC address.
IP address	View the IP address.

Wi-Fi Direct

Learn to use the Wi-Fi Direct feature to connect two devices via Wi-Fi without requiring an AP.

› Connect your device to another device

- 1 In the application list, select **Settings** → **Wi-Fi** → **Wi-Fi Direct**.
- 2 Select **Scan**.
- 3 Select a device.
When the owner of the other device accepts the connection, the devices are connected.

› Send data via Wi-Fi

- 1 Select a file or item from an appropriate application.
- 2 Select an option for sending data via Wi-Fi.
 The method for selecting an option may vary by data type.
- 3 Search for and select another device.

› Receive data via Wi-Fi

When you receive data, it is saved to your device automatically. Received data is saved to the ShareViaWifi folder.

AllShare Play

Learn to use the AllShare Play service that enables you to play contents saved on various devices over the Internet. You can play and send any file on any device to another device or web storage server via AllShare Play.

To use the AllShare Play service, you must sign in to your Google and Samsung accounts, and register two or more devices as file servers. The registration methods may vary depending on the device type. To get more details about using AllShare Play, select  → **Settings** → **Customer support**.



This feature may be unavailable depending on your region or service provider.

› Send a file

- 1 In the application list, select **AllShare Play**.
- 2 Select a device or web storage that contains media files.
- 3 Select a media category and select the tick box on a file.
- 4 Select .
- 5 Select a device or web storage to save the file.

› Share a file

- 1 In the application list, select **AllShare Play**.
- 2 Select a device or web storage that contains media files.
- 3 Select a media category and select the tick box on a file.
- 4 Select  and then select a social network site.

› Play a file on a remote device



- Supported file formats may differ depending on connected devices as a media player.
- Some files may be buffered while playing depending on the network connection.

- 1 In the application list, select **AllShare Play**.
- 2 Select a device or web storage that contains media files.
- 3 Select a media category and select the tick box on a file.
- 4 Select .
- 5 Select a device to use as a media player.
- 6 Control playback with the keys on your device.

› Manage contents on a web storage server

- 1 In the application list, select **AllShare Play**.
- 2 Select a web storage server.
- 3 View and manage your files.

› Customise AllShare Play settings

- 1 In the application list, select **AllShare Play**.
- 2 Select  → **Settings**.
- 3 Change the following options:

Option	Function
Registered storage	View web storage servers that have been added to AllShare Play.
Registered devices	View or edit devices that have been added to AllShare Play.

Option	Function
Setting up web services	Sign in to social network sites to upload files.
Auto upload photos from mobile	Set to upload photos to the web storage automatically when you sign in.
Video quality settings	Set to optimise the video quality for your device when playing videos saved on a computer.
Lock AllShare Play	Set to lock AllShare Play with the password for your Samsung account.
Language	Select a display language.
About	View AllShare Play information.

Bluetooth

Learn to exchange data or media files with other devices via Bluetooth.



- Samsung is not responsible for the loss, interception, or misuse of data sent or received via the Bluetooth feature.
- Always ensure that you share and receive data with devices that are trusted and properly secured. If there are obstacles between the devices, the operating distance may be reduced.
- Some devices, especially those that are not tested or approved by the Bluetooth SIG, may be incompatible with your device.
- Do not use the Bluetooth feature for illegal purposes (for example, pirating copies of files or illegally tapping communications for commercial purposes). Samsung is not responsible for the repercussions of illegal use of the Bluetooth feature.

› Activate the Bluetooth feature

In the application list, select **Settings** and then drag the **Bluetooth** switch to the right.

› Find and pair with another device

- 1 In the application list, select **Settings** → **Bluetooth** → **Scan**.
- 2 Select a device.
- 3 Select **OK** to match the Bluetooth PIN between two devices. Alternately, enter a Bluetooth PIN and select **OK**. When the owner of the other device accepts the connection or enters the same PIN, pairing is complete. If the pairing is successful, the device will search for available services automatically.



Some devices, especially headsets or hands-free car kits, may have a fixed Bluetooth PIN, such as 0000. If the other device has a PIN, you must enter it.

› Send data via Bluetooth

- 1 Select a file or item from an appropriate application.
- 2 Select an option for sending data via the Bluetooth feature.



The method for selecting an option may vary by data type.

- 3 Search for and pair with a Bluetooth device.

› Receive data via Bluetooth

1 In the application list, select **Settings** → **Bluetooth** and then select the tick box next to your device.



To select the length of time that your device will be visible, select  → **Visible time-out**.

2 When prompted, select **OK** to match the Bluetooth PIN or enter the Bluetooth PIN and select **OK** (if necessary).

3 Select **Accept** to confirm that you are willing to receive data.

Received data is saved to the bluetooth folder. If you receive a contact, it is saved to the phonebook automatically.

GPS

Your device is equipped with a global positioning system (GPS) receiver. Learn to activate location services and use additional GPS functions.

For better reception of GPS signals, avoid using your device in the following conditions:

- Between buildings, in tunnels or underground passages, or inside buildings
- In poor weather
- Around high voltage or electromagnetic fields
- In a vehicle with sun protection film



Do not touch or cover the area around the antenna with your hands or other objects while using the GPS functions.



This feature may be unavailable depending on your region or service provider.

› Activate location services

You must activate location services to receive location information or search the map.

- 1 In the application list, select **Settings** → **Location services**.
- 2 Change the following options:

Option	Function
Use wireless networks	Set to use Wi-Fi to find your location.
Use GPS satellites	Set to use GPS satellites to find your location.
Location and Google search	Set the device to use your current location for Google search and other Google services.

VPN connections

Learn to create virtual private networks (VPNs) and connect to them securely over the Internet.



- Your device should already be configured with Internet access. If you have trouble accessing the Internet, you must edit the connections. If you are not sure what information to enter, ask your VPN administrator.
- To use this feature, you must activate the screen lock feature.

› Set up a VPN profile

- 1 In the application list, select **Settings** → **More settings** → **VPN** → **Add VPN network**.
- 2 Change the following options:

Option	Function
Name	Enter a name for the VPN server.
Type	Select a VPN type.
Server address	Enter the address of the VPN server.
L2TP secret	Enter an L2TP secret password.
IPSec identifier	Enter a user name.
IPSec pre-shared key	Enter a pre-shared security key.
IPSec user certificate	Select a user certificate that the VPN server will use to identify you. You can import certificates from the VPN server or download them from the Internet.
IPSec CA certificate	Select a certificate authority (CA) certificate that the VPN server will use to identify you. You can import certificates from the VPN server or download them from the Internet.
IPSec server certificate	Select a server certificate that the VPN server will use to identify you. You can import certificates from the VPN server or download them from the Internet.

Option	Function
PPP encryption (MPPE)	Set to encrypt data before sending it to the VPN server.
Show advanced options	Set to change the advanced network settings.



The options available may vary depending on the VPN type.

3 When you are finished, select **Save**.

▶ Connect to a private network

- 1 In the application list, select **Settings** → **More settings** → **VPN**.
- 2 Select a private network.
- 3 Enter the user name and password, and then select **Connect**.

Tools

Alarm

Learn to set and control alarms for important events.

› Set an alarm

1 In the application list, select **Alarm**.

2 Select .

3 Set the details of the alarm.



4 When you are finished, select **Done**.



To deactivate an alarm, select the clock icon next to the alarm. To delete an alarm, select .

› Stop an alarm

When the alarm sounds,

- To stop the alarm, select  and then drag your finger outside of the large circle.
- To silence the alarm for the snooze period, select  and then drag your finger outside of the large circle.

Calculator

Learn to perform calculations with your device.

› Perform a calculation

- 1 In the application list, select **Calculator**.
- 2 Use the keys on the screen to perform basic calculations.

› View the calculation history

- 1 In the application list, select **Calculator**.
- 2 Perform a calculation.
- 3 Select  to hide the calculator keypad.
The calculation history appears.

Downloads

Learn to manage logs of files you have downloaded from the web or email.

- 1 In the application list, select **Downloads**.
- 2 Select a download category.
- 3 To open a downloaded file, select the log.
To delete a log, select the tick box and select .



Dropbox

Learn to use the Dropbox cloud storage service to save and share your files with others. When you save files to your Dropbox folder, your device automatically synchronise with the web server and any other computers that have Dropbox installed.

› Activate Dropbox

- 1 In the application list, select **Dropbox** → **Start**.
- 2 Enter an email address and password, and then select **Log in**.
If you are a new user, select **New to Dropbox? Create a free account** to create an account.
- 3 Select **Next**.
- 4 Select **Turn on** to automatically upload photos and videos captured by the camera on your device.

› Upload files to your Dropbox folder

- 1 In the application list, select **Dropbox**.
- 2 Select  →  → **Upload here** → **Photos or videos** or **Other files**.
- 3 Select files.
- 4 Select **Upload**.
The files in the folder will be added to the web server and your computer at home.

› View a file

- 1 In the application list, select **Dropbox** → .
- 2 Select a file.

My Files

Learn to access various types of files saved in your device.

› Supported file formats



Your device supports the following file formats:

Type	Format
Image	bmp, gif, jpg, png
Video	avi, 3gp/mp4, wmv, flv, mkv, webm
Music	m4a, wma, mp3, flac, ogg, aac
Sound	amr-nb/wb, wav, mid, midi, xmf, mxmf, i-melody (imy), sp-midi, rtttl/rtx, ota
Others	doc, docx, txt, hwp, rtf, ppt, pptx, pps, xls, xlsx, csv, pdf, htm, html, webm, flac, ogg













- Some file formats are not supported depending on the device's software.
- If a file size exceeds the memory available, an error may occur when you try to open the file.

› View a file

- 1 In the application list, select **My Files**.
- 2 Select a folder.
 - To move up one level in the file directory, select .
 - To return to the Home directory, select .
- 3 Select a file.

From the folder list, access the following options:

- To search for files saved in your device, select .
- To view the files in the thumbnail view, select .
- To create folders for managing files, select .
- To change the file manager settings, select  → **Settings**.
- To sort files or folders, select the **Name** drop-down menu and select an option.
- To send a file to others, select the tick box and select .
- To copy or move the files or folders to another file folder, select the tick boxes and select  or .
- To delete files or folders, select the tick boxes and select .
- To change the name of a file or a folder, select the tick box and select  → **Rename**.
- To view file or folder details, select the tick box and select  → **Details**.

Polaris Office

Learn to create or view documents with your device.



This feature may be unavailable depending on your region or service provider.

› Create a document

1 In the application list, select **Polaris Office**.



If you are launching this application for the first time, register as an online user or skip the registration.

2 Select  → a document type.

3 Select a template (if necessary).

4 Create the document.

5 When you are finished, select .

6 Enter a name for the document and select a memory location for saving the document, and then select **Save**.

› Open a document









1 In the application list, select **Polaris Office**.

2 Select **Browser** → a document file.

To open a recently-used file, select a file under **Recent documents**.

3 View the document.

From the document view, access the following options:

- To zoom in or out, place two fingers on the screen and slowly spread them apart or pinch them together.
- To undo your last action, select .
- To redo your last action, select .
- To add an item to the document, select .
- To open the editing toolbar, select .
- To start a slide show in a PowerPoint document, select . Tap the screen to move to the next slide. Select  to exit the slide show.
- To search for text in a Text document, select .
- To use additional options with the document, select .





The options available may vary depending on the document type.

› Manage documents online

- 1 In the application list, select **Polaris Office**.
- 2 Select **Clouds** → **Add account** → a cloud service.
- 3 Enter your email address and password to access your account, and then select **OK**.
- 4 View and manage your documents on the server.



Google

Learn to search for data in your device or information on the Internet.

- 1 In the application list, select **Google**.
- 2 Enter a keyword and select .
To search for data by voice, select  and say a keyword into your device's microphone.
- 3 Select a search result.

World Clock

Learn to view the time in another region and set world clocks to appear on your display.

- 1 In the application list, select **World Clock** → .
 - 2 Enter a city name or select one from the globe.
 - 3 Select .
-  To apply summer time to the clock, tap and hold the clock, and then select **DST settings**.

Settings

Access the setting options

- 1 In the application list, select **Settings**.
- 2 Select a setting category, and then select an option.

Wi-Fi

Activate the Wi-Fi feature to connect to a Wi-Fi AP and access the Internet or other network devices.

To use options, select .

- **Advanced:** Customise Wi-Fi settings.
- **WPS push button:** Connect to a secured Wi-Fi AP with a WPS button.
- **WPS PIN entry:** Connect to a secured Wi-Fi AP with a WPS PIN.

Bluetooth

Activate the Bluetooth feature to exchange information over short distances.

Data usage

Keep track of your data usage amount.

More settings

Change the settings to control connections with other devices or networks.

› Flight mode

Activate Flight mode to disable all wireless functions on your device. You can use only non-network features.

› VPN

Set up and manage virtual private networks (VPNs).

› Nearby devices

- **File sharing:** Activate media sharing to allow other DLNA certified devices to access media files on your device.
- **Shared contents:** Set to share your contents with other devices.
- **Device name:** Enter a media server name for your device.
- **Allowed devices list:** View the list of devices that can access your device.
- **Not-allowed devices list:** View the list of devices that are blocked from accessing your device.
- **Download to:** Select a memory location for saving downloaded media files.
- **Upload from other devices:** Set to accept uploads from other device.

› Kies via Wi-Fi

Connect your device to Samsung Kies via Wi-Fi.

Blocking mode

Select which notifications will be blocked or set to allow notifications for calls from specified contacts in Blocking mode.

Sound

Change the settings for various sounds on your device.

- **Volume:** Adjust the volume for various sounds on your device.
- **Default notifications:** Select a ringtone to alert you to events.
- **Touch sounds:** Set the device to sound when you select an application or option.
- **Screen lock sound:** Set the device to sound when you lock or unlock the touch screen.

Display

Change the settings to control the display and backlight on your device.

- **Wallpaper:**
 - **Home screen:** Select a background image for the Home screen.
 - **Lock screen:** Select a background image for the locked screen.
 - **Home and lock screens:** Select a background image for the Home screen and the locked screen.
- **Brightness:** Adjust the brightness of the display.
- **Screen timeout:** Select the length of time that the device waits before turning off the display backlight.

- **Smart stay:** Set to prevent the display backlight from turning off while you are looking at the display.
- **Font style:** Change the font type for the display text.
- **Font size:** Change the font size for creating or showing items in applications.
- **Quick launch:** Select an application to launch with the quick launch shortcut. The shortcut icon will change according to the application you specify.

Storage

View memory information for your device and memory card. You can also format the memory card.



Formatting a memory card will permanently delete all data from the memory location.



The actual available capacity of the internal memory is less than the specified capacity because the operating system and default applications occupy part of the memory.

Power saving mode

Activate Power saving mode and change the settings for Power saving mode.

- **CPU power saving:** Set the device to limit some system resource usage.
- **Screen power saving:** Set the device to decrease the brightness of the display.
- **Learn about power saving:** View information for saving battery power.

Battery

View the amount of battery power consumed by your device.

Application manager

View and manage the applications on your device.



Location services

Change the settings for location services.

- **Use wireless networks:** Set to use Wi-Fi for finding your location.
- **Use GPS satellites:** Set to use GPS satellites for finding your location.
- **Location and Google search:** Set the device to use your current location for Google search and other Google services.

Lock screen

Change the settings for securing your device.

- **Screen lock:** Activate the screen lock feature.
- **Lock screen options:**
 -  The settings are applied only when you set the swipe lock option.
 - **Shortcuts:** Set to show and edit application shortcuts on the locked screen.
 -  This feature may be unavailable depending on your region or service provider.

- **Information ticker:** Set to show news or stock information on the locked screen.



This feature may be unavailable depending on your region or service provider.

- **Clock:** Set to show the clock on the locked screen.
- **Help text:** Set to show the help text on the locked screen.
- **Owner information:** Enter your information that is shown on the locked screen.

Security

Change the settings for securing your device.

- **Encrypt device:** Set a password to encrypt data saved on the device. You must enter the password each time you turn on the device.



Charge the battery before enabling this setting because it may take more than an hour to encrypt your data.

- **Encrypt external SD card:**

- **Encrypt:** Set to encrypt files when you save them to a memory card.
- **Full encryption:** Set to encrypt all files on a memory card.
- **Exclude multimedia files:** Set to encrypt all files on a memory card, except for media files.



If you reset your device to the factory defaults with this setting enabled, the device will not be able to read your encrypted files. Disable this setting before resetting the device.

- **Remote controls:** Set to allow remote control of your device via the Internet when your device is lost or stolen.

- **Find my mobile web page:** Access the SamsungDive website (www.samsungdive.com). You can track and control your lost or stolen device on the SamsungDive website.
- **Make passwords visible:** Set to show your passwords as you enter them.
- **Device administrators:** View the administrators you have approved for your device. You can allow device administrators to apply new policies to your device.
- **Unknown sources:** Set to download applications from any source. If you do not select this option, you can download applications only from Play Store.
- **Trusted credentials:** Set to use certificates and credentials to ensure the secure use of applications.
- **Install from device storage:** Install encrypted certificates that are saved on a memory card.
- **Clear credentials:** Delete credentials from the device and reset the password.

Language and input

Change the settings for languages and text input.

› Language

Select a display language.

› Default

Select a text input method.

› Google voice typing

Activate the Google voice input feature to enter text by voice. To change the voice input settings, select ⚙️.

- **Choose input languages:** Select input languages for Google voice recognition.
- **Block offensive words:** Set to prevent the device from recognising offensive words in voice inputs.
- **Download offline speech recognition:** Download and install language data for offline voice input.

› Samsung keyboard

To change the Samsung keypad settings, select ⚙️.

- **Input languages:** Select input languages to use with the keypad.
- **Predictive text:** Activate XT9 mode to predict words based on your input and show word suggestions.
- **Continuous input:** Set to enter text by sweeping on the keypad.
- **Handwriting:** Change the settings for Handwriting mode, such as recognition time, pen thickness, or pen colour.
- **Advanced:**
 - **Auto capitalisation:** Set to capitalise the first letter of a sentence automatically.
 - **Auto-punctuate:** Set the device to insert a full stop when you double-tap the space bar.
 - **Character preview:** Set the device to show a preview image of each letter you tap.
 - **Key-tap sound:** Set the device to sound when you tap a key.
- **Tutorial:** View the tutorial for using the Samsung keypad.
- **Reset settings:** Reset the Samsung keypad settings to the factory defaults.

› Voice search

- **Language:** Select a language for Google voice recognition.
- **Speech output:** Set the device to provide voice feedback to alert you to the current action.
- **Block offensive words:** Set to hide offensive words from voice search results.
- **Download offline speech recognition:** Download and install language data for offline voice input.

› Text-to-speech output

- **Preferred TTS engine:** Select a speech synthesis engine. To change the settings for speech synthesis engines, select ⚙️.
- **Speech rate:** Select a speed for the TTS feature.
- **Listen to an example:** Listen to the spoken text for an example.
- **Driving mode:** Activate Driving mode to provide audible notifications for event details.

› Pointer speed

Adjust the pointer speed for the mouse or trackpad connected to your device.

Back up and reset

Change the settings for managing settings and data.

- **Back up my data:** Set to back up your settings and application data to the Google server.
- **Backup account:** Set up or edit your Google backup account.
- **Automatic restore:** Set to restore your settings and application data when you must reinstall an application.
- **Factory data reset:** Reset your settings to the factory defaults and delete all your data.

Add account

Add your email or SNS accounts.

Accessory

Dock sound: Set the device to play a sound when your device is connected to or removed from a desktop dock.

Date and time

Change the settings to control how time and date appears on your device.



If the battery remains fully discharged or removed from the device, the time and date will be reset.

- **Set date:** Set the current date manually.
- **Set time:** Set the current time manually.
- **Select time zone:** Select a time zone.
- **Use 24-hour format:** Set to show the time in 24-hour format or 12-hour format.
- **Select date format:** Select a date format.

Accessibility

Accessibility services are special features for those with physical challenges. Change the settings to improve accessibility to the device's interface and features.

- **Auto-rotate screen:** Set the interface to rotate automatically when you rotate the device.

- **Screen timeout:** Select the length of time that the device waits before turning off the display backlight.
- **Speak passwords:** Set the device to read aloud passwords you enter on websites with TalkBack.
- **Accessibility shortcut:** Add a shortcut to accessibility settings that appears when you press and hold the Power key.
- **TalkBack:** Activate TalkBack, which provides voice feedback.
- **Font size:** Change the font size in the calendar, email, phonebook, and memo applications.
- **Text-to-speech output:**
 - **Preferred TTS engine:** Select a speech synthesis engine. To change the settings for speech synthesis engines, select .
 - **Speech rate:** Select a speed for the TTS feature.
 - **Listen to an example:** Listen to the spoken text for an example.
 - **Driving mode:** Activate Driving mode to provide audible notifications for event details.
- **Enhance web accessibility:** Set applications to install web scripts to make their web content more accessible.
- **Mono audio:** Enable mono sound when you listen to audio with one earbud.
- **Turn off all sounds:** Mute all device sounds.
- **Tap and hold delay:** Set the recognition time for tapping and holding the screen.

Developer options

Activate and change the settings for application development.

- **Desktop backup password:** Set a password to secure your backup data.
- **Stay awake:** Set the screen to remain on while you are charging the battery.
- **Protect SD card:** Set to request a confirmation when reading data from a memory card.
- **USB debugging:** Activate USB debugging mode to connect your device to a computer with a USB cable.
- **Allow mock locations:** Allow mock locations and service information to be sent to a Location Manager service for testing.
- **Select debug app:** Select applications to debug and prevent errors when you pause debugging.
- **Wait for debugger:** Set to prevent the selected application from loading until the debugger is ready.
- **Show touches:** Set to show the pointer when you touch the screen.
- **Show pointer location:** Set to show the coordinates and traces of the pointer when you touch the screen.
- **Show layout boundaries:** Set to show boundaries.
- **Show GPU view updates:** Set to flash areas of the screen when they are updated with the GPU.
- **Show screen updates:** Set to flash areas of the screen when they are updated.
- **Window animation scale:** Select a speed for opening and closing pop-up windows.
- **Transition animation scale:** Select a speed for switching between screens.
- **Animator duration scale:** Select how long pop-up windows will be shown.

- **Disable hardware overlays:** Set to hide hardware overlays.
- **Force GPU rendering:** Set to use 2D hardware acceleration to improve graphic performance.
- **Strict mode:** Set the device to flash the screen when applications perform long operations.
- **Show CPU usage:** Set to list all active processes.
- **Profile GPU rendering:** Set to check the time of GPU rendering time.
- **Enable traces:** Set to capture traces of application and system performance.
- **Do not keep activities:** Set to end a running application when you launch a new application.
- **Limit background processes:** Set to limit the number of processes that can run in the background.
- **Show all ANRs:** Set the device to alert you to unresponsive applications that are running in the background.

About device

View information about your device, such as model number and version.



You can download and install firmware update with the firmware over-the-air (FOTA) service. To check for firmware updates, select **Software update** → **Update**.

Troubleshooting

Your device displays network or service error messages

- When you are in areas with weak signals or poor reception, you may lose reception. Move to another area and try again.
- You cannot access some options without a subscription. Contact your service provider for more details.

The touch screen responds slowly or improperly

If your device has a touch screen and the touch screen is not responding properly, try the following:

- Remove any protective covers from the touch screen. Protective covers may prevent the device from recognising your inputs and are not recommended for touch screen devices.
- Ensure that your hands are clean and dry when tapping the touch screen.
- Restart your device to clear any temporary software bugs.
- Ensure that your device's software is upgraded to the latest version.
- If the touch screen is scratched or damaged, take your device to a Samsung Service Centre.

Your device freezes or has fatal errors

If your device freezes or hangs, you may need to close applications or reset the device to regain functionality. If your device is still responsive and an application is frozen, close the application with the task manager. If your device is frozen and unresponsive, press and hold the Power key for 8-10 seconds.

If this problem persists, perform a factory data reset. In the application list, select **Settings** → **Back up and reset** → **Factory data reset** → **Reset device** → **Erase everything**.

The device beeps and the battery icon is empty

Your battery is low. Recharge the battery to continue using the device.

The battery does not charge properly or the device turns off

If the battery will no longer charge completely, you need to replace it with a new battery. Take your device to your local Samsung Service Centre.

Your device is hot if touched

When you use applications that require more power or use applications on your device for an extended period of time, your device may feel hot. This is normal and should not affect your device's lifespan or performance.

Error messages appear when launching the camera

Your device must have sufficient memory and battery power available to operate the camera application. If you receive error messages when launching the camera, try the following:

- Charge the battery.
- Free some memory by transferring files to a computer or deleting files from your device.
- Restart the device. If you are still having trouble with the camera application after trying these tips, contact a Samsung Service Centre.

Error messages appear when opening music files

Some music files may not play on your device for a number of reasons. If you receive error messages when opening music files on your device, try the following:

- Free some memory by transferring files to a computer or deleting files from your device.
- Ensure that the music file is not Digital Rights Management (DRM)-protected. If the file is DRM-protected, ensure that you have the appropriate licence or key to play the file.
- Ensure that your device supports the file type.

Another Bluetooth device is not located

- Ensure that the Bluetooth feature is activated on your device.
- Ensure that the Bluetooth feature is activated on the device you wish to connect to, if necessary.
- Ensure that your device and the other Bluetooth device are within the maximum Bluetooth range (10 m).

If the tips above do not solve the problem, contact a Samsung Service Centre.

A connection is not established when you connect the device to a computer

- Ensure that the USB cable you are using is compatible with your device.
- Ensure that you have the proper drivers installed and updated on your computer.
- If you are a Windows XP user, ensure that you have Windows XP Service Pack 3 or higher installed on your computer.
- Ensure that you have Samsung Kies 2.0 or Windows Media Player 10 or higher installed on your computer.

Index

- alarms 97
- AllShare Play 88
- applications
 - closing 31
 - downloading 30
 - launching 28
 - multitasking 31
 - organising 29
 - uninstalling 30
- battery
 - charging 14
- Bluetooth 91
- calculator 98
- calendar
 - creating events 79
 - viewing events 80
- camera
 - changing camcorder settings 63
 - changing camera settings 59
 - recording videos 61
 - taking photos 56
- connectivity
 - AllShare Play 88
 - Bluetooth 91
 - GPS connections 93
 - USB connections 82
 - VPN connections 94
 - Wi-Fi 84
- contacts
 - creating 77
 - creating groups 78
 - finding 77
 - importing/exporting 78
- device lock 34
- display
 - brightness 33
 - font style 32
 - language 31
 - settings 107
 - wallpaper 32
- file manager 100
- find my mobile 35
- flight mode 19
- gallery 67
- Google+ 55
- Google Mail 49
- Google Maps 42
- Google Messenger 55
- Google Talk 53
- home screen
 - adding panels 27
 - moving items 26
 - removing items 27
 - removing panels 27
 - using the notifications panel 26
 - using widgets 28
- indicator icons 25
- Internet 38
- key functions 14

maps

- getting directions 43
- searching for locations 42
- searching for places nearby 44
- using the navigation 44

memory card

- formatting 18
- inserting 17
- removing 18

memos

- creating 81
- viewing 81

messages

- sending email 51
- sending Google Mail 49
- viewing email 52
- viewing Google Mail 50

music player 73

photo editor 70

photos

- editing 70
- taking 56
- viewing 67

Play Store 45

Polaris Office 102

power saving 16, 108

Samsung Apps 46

settings 105

silent mode 32

sound

- device volume 32
- settings 107
- touch tone 32

task manager 31

text input

- copy and paste 37
- with Google voice input 36
- with Samsung keypad 36

touch screen

- locking/unlocking 23
- using 20

touch tone 32

unpack 11

USB connections

- as camera device 83
- as media device 83
- with Samsung Kies 82
- with Windows Media Player 83

video editor 71

videos

- playing 64, 69
- recording 61
- uploading to YouTube 48

VPN connections 94

web browser 38

Wi-Fi 84

world clock 104

YouTube 47

Free Manuals Download Website

<http://myh66.com>

<http://usermanuals.us>

<http://www.somanuals.com>

<http://www.4manuals.cc>

<http://www.manual-lib.com>

<http://www.404manual.com>

<http://www.luxmanual.com>

<http://aubethermostatmanual.com>

Golf course search by state

<http://golfingnear.com>

Email search by domain

<http://emailbydomain.com>

Auto manuals search

<http://auto.somanuals.com>

TV manuals search

<http://tv.somanuals.com>