

Enterprise IP Solutions

**Office**Serv

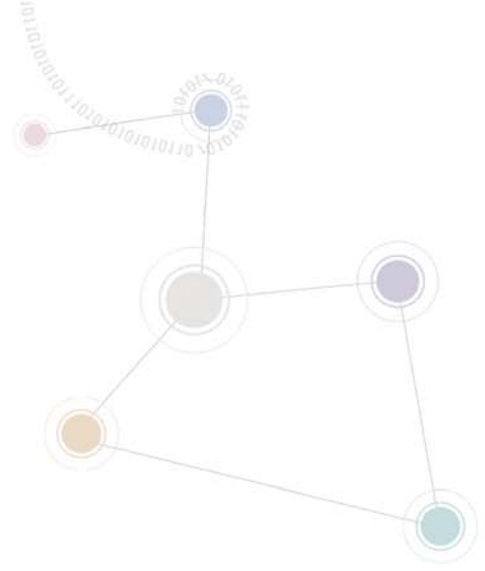

## IP phone User Guide

ITP-5121D / ITP-5114D / ITP-5107S

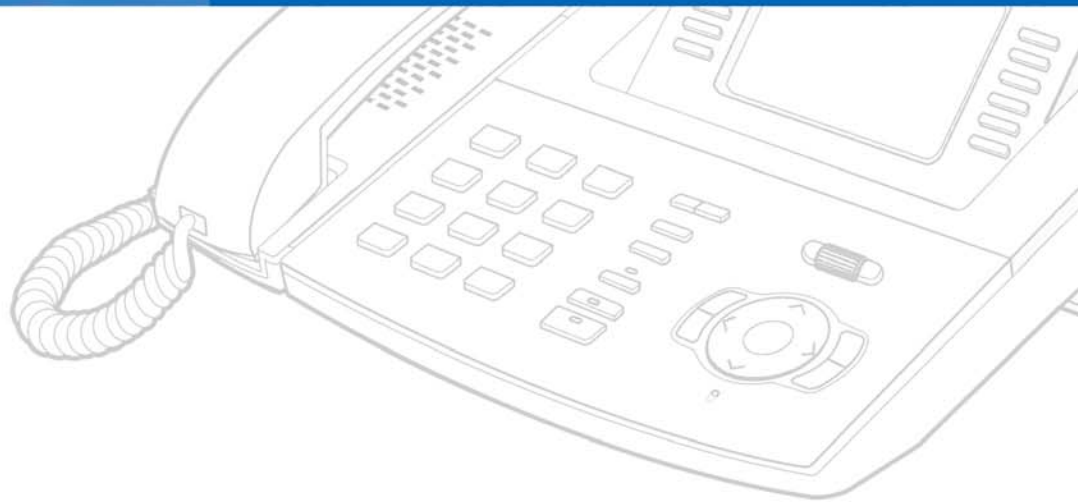

# SAFETY CONCERNS

For product safety and correct operation, the following information must be given to the operator/user and shall be read before the installation and operation.

## Conventions



### Warning

Provides information or instructions that you should follow in order to avoid personal injury or fatality.



### Caution

Provides information or instructions that you should follow in order to avoid a service failure or damage to your phone.



### Note

Indicates additional information for reference.



### Checks

Provides the operator with checkpoints for stable system operation.

## Symbols



### Caution

Indication of a general caution



### Restriction











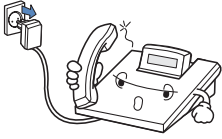



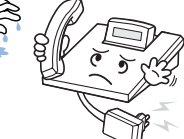

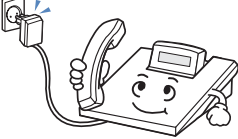
Indication for prohibiting an action for a product



### Instruction

Indication for commanding a specifically required action

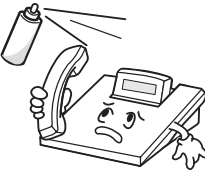
## Warning

  <p><b>Pull out the power plug when the phone is not used for a long time.</b></p> <p>It may cause fire or electric shock.</p>	  <p><b>Do not use a damaged power plug or a loose outlet.</b></p> <p>It may cause fire or electric shock.</p>	  <p><b>Do not pull or bend the power cord by force. Do not touch the power plug with wet hands.</b></p> <p>It may cause the damage of the power cord, fire or electric shock.</p>
  <p><b>Pull out the power plug and brush with a cloth it if the contact surface with power plug is dusty or gets wet. Contact the service center if foreign materials or water</b></p> <p>It may cause fire or electric shock.</p>	  <p><b>Avoid placing objects containing water such as vases, cups, cosmetics, and medicines near the phone.</b></p> <p>Moisture in the phone may cause a fire and electric shocks.</p>	  <p><b>Do not place the phone in a dusty area or areas with extreme or volatile changes in temperature.</b></p> <p>It may cause a fire or electric shocks.</p>
  <p><b>Do not install the phone near a heater or flames(cigarette lighter, heating apparatus, etc.).</b></p> <p>It may cause a fire or electric shocks.</p>	  <p><b>Do not use flammable solvent or materials near the phone. Do not store them near the phone.</b></p> <p>It may cause a fire or electric shocks.</p>	  <p><b>If the phone makes excessive noise, emits an odor, or smoke, immediately unplug the phone and call your Authorized Samsung Reseller.</b></p> <p>It may cause a fire or electric shocks.</p>



## Caution

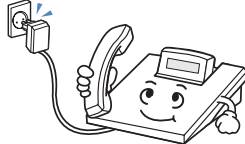

**Be sure to connect the LAN cable linked to network to the LAN connection port of the telephone, not to the PC-connection port of the telephone.**

If the LAN cable is connected to the PC connection port, both telephone and PC communications will be disabled.



**Use a soft dry cloth to clean the phone. Do not use any chemical solvents like wax, benzene, alcohol, thinner, aerosols, lubricant, or detergent.**

The use of chemicals on the phone may cause fading/discoloring or damage to the parts.

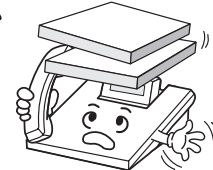

**Do not place heavy things on the phone.**

It may cause damage to some parts.

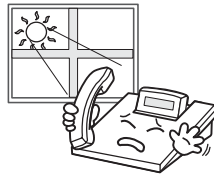

**Do not install the phone on an unstable surface or in direct sunlight.**

It may cause severe damage to the plastic case of the phone, and reduced the performance of your phone.



**Do not separate, repair or remodel the phone arbitrarily.**

If a repair is needed, please contact your Authorized Samsung Reseller.

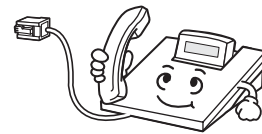

**Do not turn off the power while the telephone is upgrading its software.**

Failure to do so interrupts the upgrades by stopping the operation of the telephone.

# TABLE OF CONTENTS



## SAFETY CONCERNS

2

Conventions.....	2
Symbols .....	2
Warning .....	3
Caution .....	4



## BEFORE USE ОПРЕДЕЛЕНА.

ОШИБКА! ЗАКЛАДКА НЕ

Main Features .....	7
Checking Parts in the Package .....	9
ITP-5121D/ITP-5114D (Front Side) .....	10
ITP-5107S (Front Side).....	10
Installing the phone .....	11
ITP-5121D/ITP-5114D .....	11
ITP-5107S .....	12
Installing the IP Phone Support .....	13



## THINGS YOU SHOULD KNOW

15

Adjusting Volume .....	15
Adjusting the Handset Volume.....	15
Adjusting Speaker Volume.....	16
Adjusting Ring Volume .....	16
Entering Characters.....	17
Special Button Used .....	17
Entering Characters.....	19
Phone Status Indicator .....	20
Button LED .....	20







## BASIC FUNCTIONS ОШИБКА! ЗАКЛАДКА НЕ ОПРЕДЕЛЕНА.

Making a Call .....	21
Calling an Extension Number .....	21
Calling an Outside number .....	22
Using a Speakerphone .....	23
New Call .....	23
Redial .....	24
Save Number with Redial .....	25
Answering a Call .....	26
Using a Handset .....	26
Using a Speakerphone .....	26
Call Pickup .....	27
Features Used During a Call .....	28
Hold an Intercom Call .....	28
Hold an Outside Call .....	29
Mute .....	29
Transferring a Call .....	30
Conference Calls .....	31



## APPLICATION MENU 32

Navigation Buttons .....	32
Menu Button (  ) .....	32
Send Button (  ) .....	33
End Button (  ) .....	33
Cancel button (  ) .....	33
Enter button (  ) .....	33
Direction button .....	34
Entering Application Menus .....	35
How to Select Menu .....	35
Application Menus .....	36



## TROUBLESHOOTING 37



## ANNEX 39

Product Specifications .....	39
------------------------------	----

# BEFORE USE

## Main Features

### IP Network

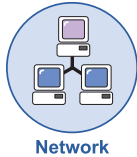

The ITP-5121D/ITP-5114D/ITP-5107S IP phone provides voice communication through your installed data network, making installation of additional telephone lines unnecessary.

### Application menu

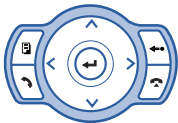

This button allows you to access the IP phone's menu functions. The menu functions include the recent outgoing call log, incoming call log, system directory functions, transferring incoming calls, inquiry of speed dial numbers, and alarm function.

### Speed Dial



For frequently used phone numbers, you can press one speed dial button to make a call to the speed dial number.

### Pickup



You can answer a call at another extension.

### Automatic Redial/Retry



When your call is important but your party is busy on another call, you can use automatic redial/retry function. The IP phone redials the called number automatically until your party is free to take your call.

## Hold

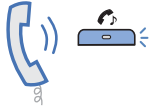

You can use the Hold feature when you need something or another call arrives. Use this button to temporarily hold the current call until you are ready to resume the call. You can even pickup a held call at another station.

## Conference Calls



This button is used when multiple parties need to be connected simultaneously during a phone conversation. Up to five parties including you can be connected in a conference call.

## Call Forwarding

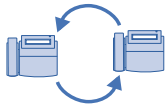

If you cannot answer an incoming call, the call can be forwarded to another extension (unconditionally, while you are busy on a call, or when you are away from your phone).

## Do Not Disturb



When you do not want to be disturbed, the DND function can be set to block incoming calls and the phone will not ring. Your calls can be forwarded to another station when you do not wish to be disturbed.

## Paging



If you have an urgent announcement to make, or you wish to locate a colleague, you can page through the speaker of other stations, or through optional external speakers.

## Call ID



When there is an incoming call, the caller ID or name will be displayed on the LCD screen. You can see who is calling before answering the call and respond accordingly.



If you have any questions or concerns regarding the features which are not introduced in this user guide, refer to the User Guide at e-manual site (<http://www.samsungdocs.com>).



## Checking Parts in the Package

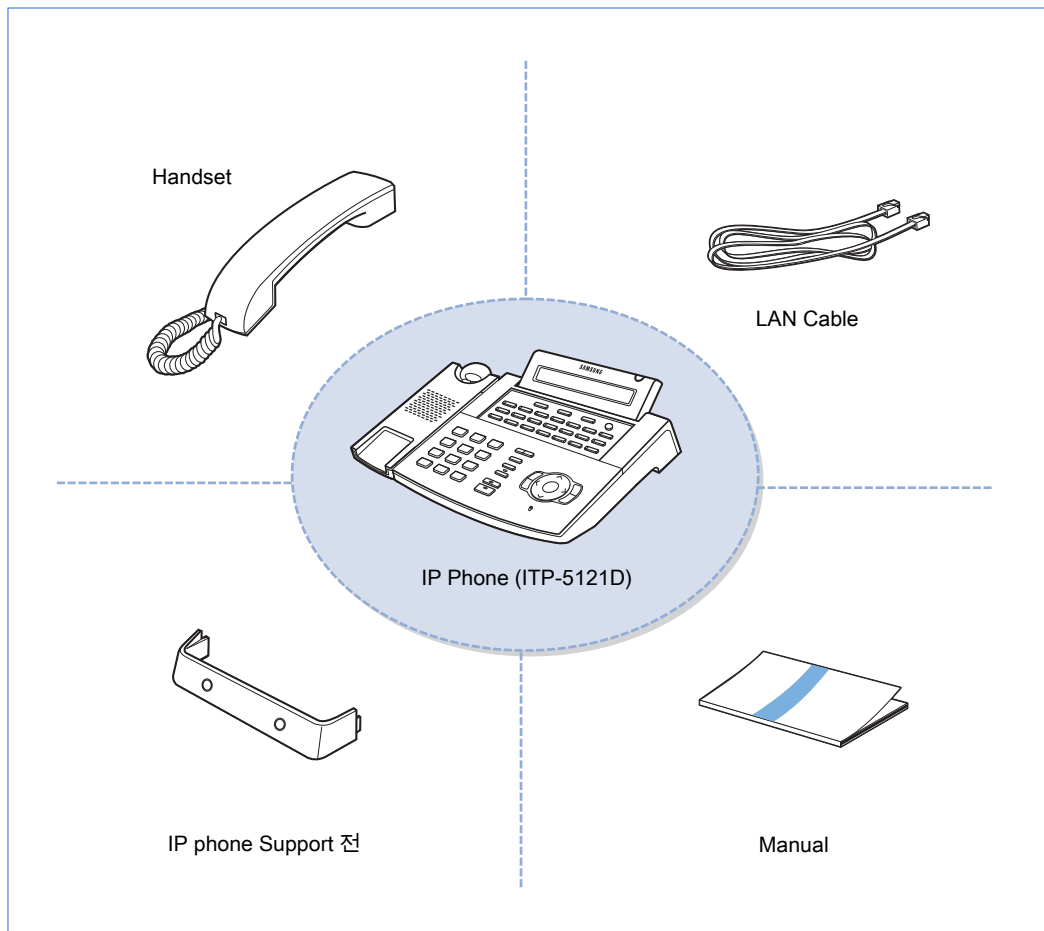

- If any item is missing or damaged, contact your dealer.
- The above figure shows ITP-5121D as a sample. If you purchase ITP-5114D/ITP-5107S, the relevant phone is included.

## ITP-5121D/ITP-5114D (Front Side)

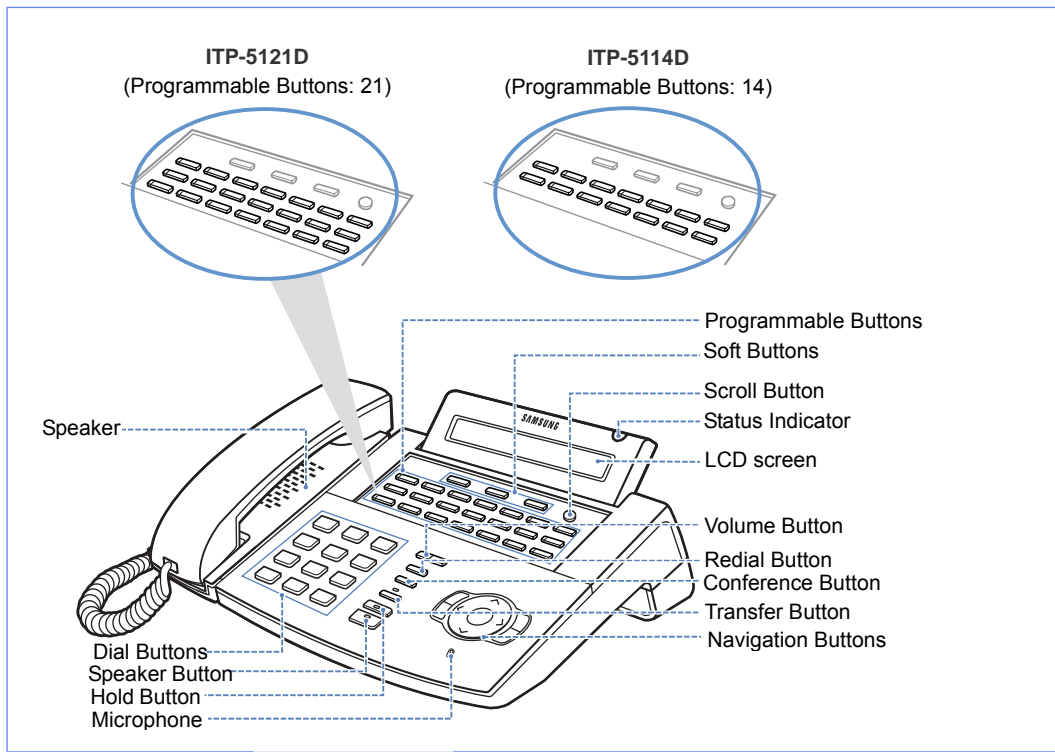

## ITP-5107S (Front Side)

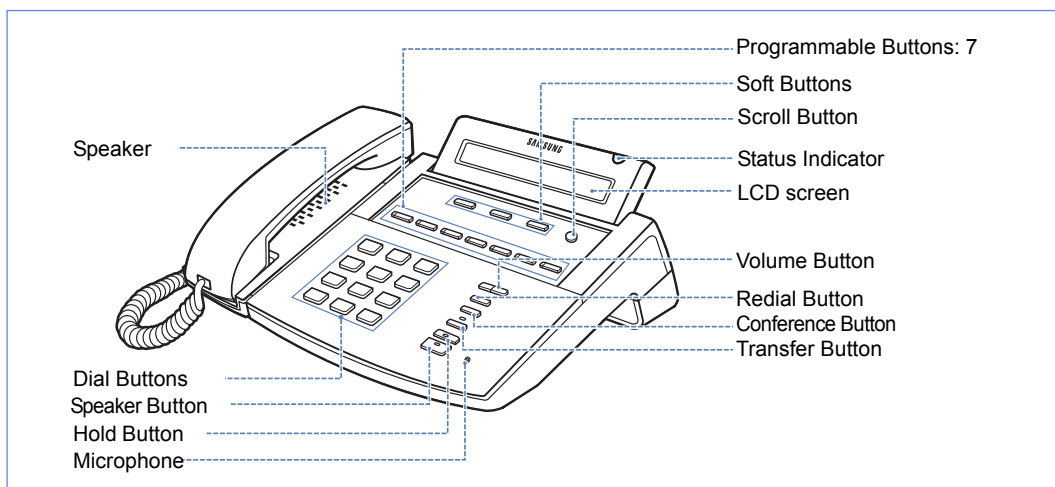

# Installing the phone

## ITP-5121D/ITP-5114D

- 1 Connect the handset to the **handset connection port** of the phone.
- 2 Connect the LAN cable with a network connection to the LAN connection port of the phone. Make sure the LAN cable is not connected to the PC connection port.
- 3 Connect one end of the LAN cable (provided with the phone) for PC connection to the **PC connection port** of the phone, and the other end of the cable to the network port of the PC.
- 4 Connect the power adapter to the power connection port of the phone. Connect the plug of the power adapter to the power outlet. The phone will boot up.

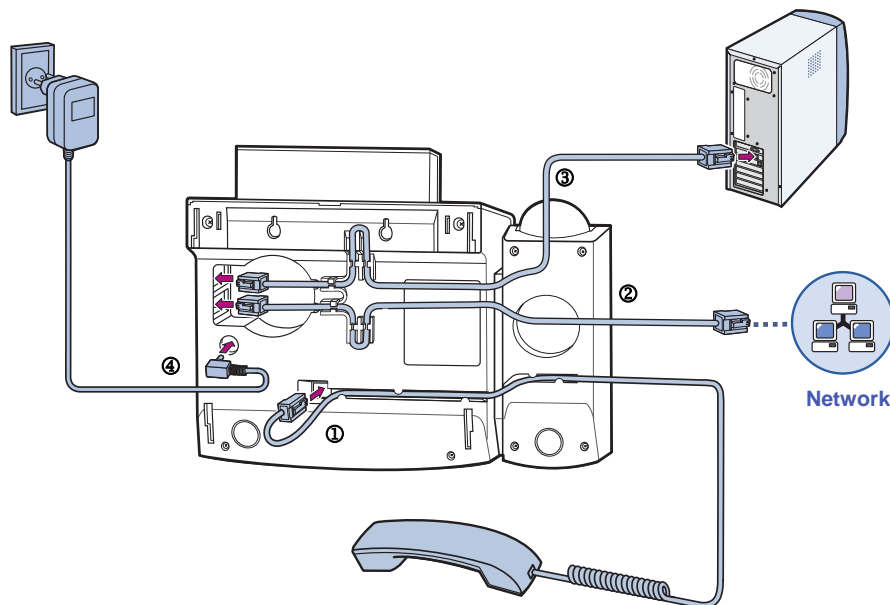

## ITP-5107S

- 1 Connect the handset to the **handset connection port** of the phone.
- 2 Connect the LAN cable with a network connection to the LAN connection port of the phone.
- 3 Connect the power adapter to the **power connection port**. Connect the plug of the power adapter to the power outlet. The phone will boot up.

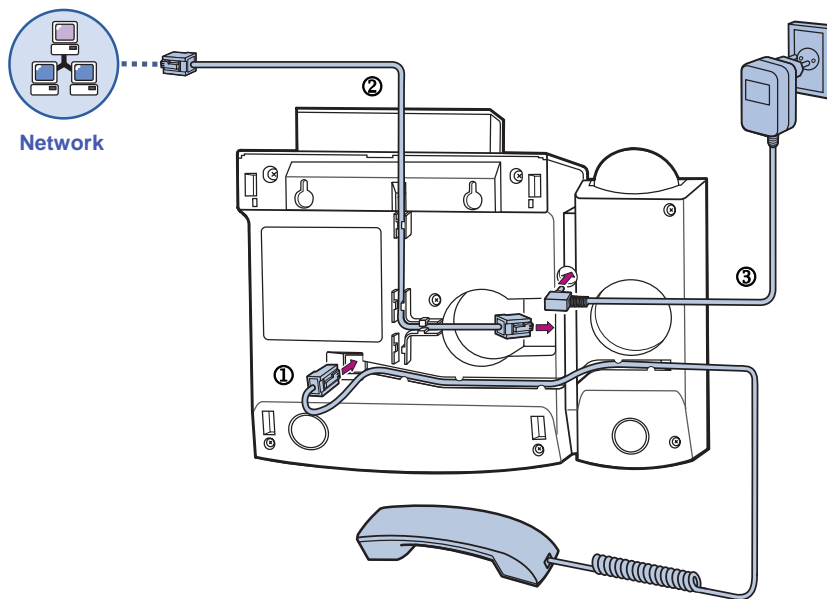

## Installing the IP Phone Support

### Using as Desktop Phone

Insert the both ends of the support into two upper grooves in the bottom of the phone as shown in the figure below.

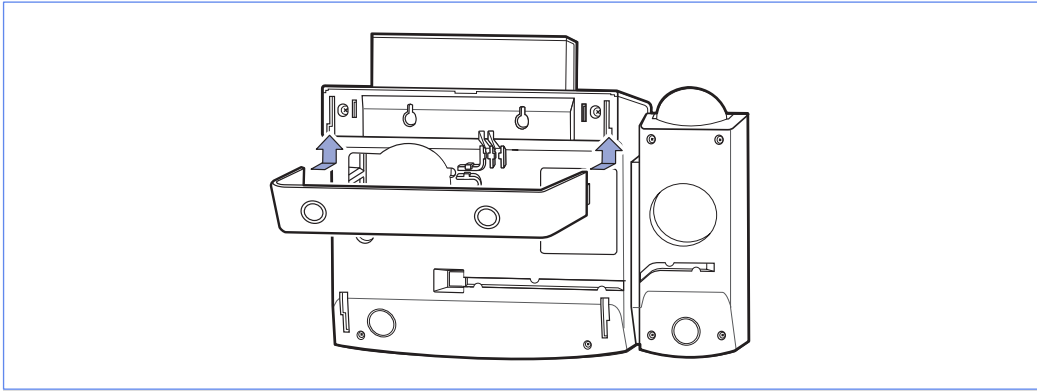

### Using as Wall-Mounted Phone

Insert the both ends of the support into two lower grooves in the bottom of the phone as shown in the figure below. Hang the two holes for wall-hanging in the upper part of the bottom of the phone on the wall with screws attached.

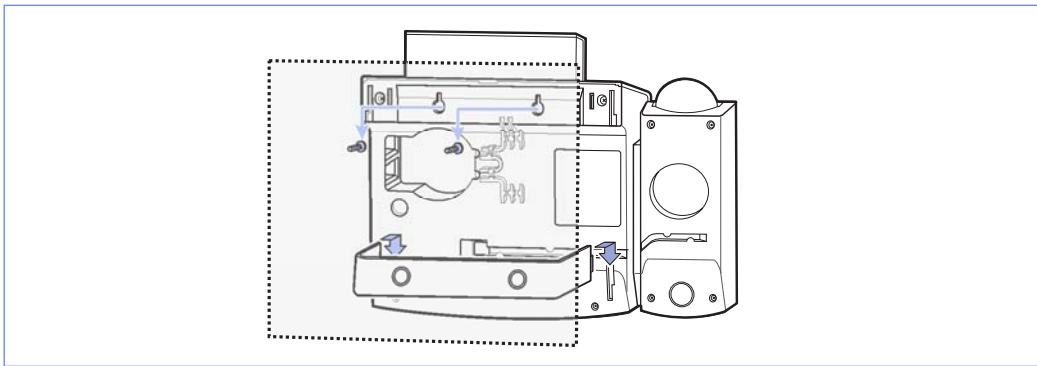

- To use as a wall-mounted phone, mark the positions of the holes for screws on a paper, apply the paper on the wall and fix screws to the correct positions.
- For the phone, ITP-5107S, push the both sides of the support lightly to insert into the grooves.

To use as wall-mounted phone, the position of the handset hanger must be changed to prevent the handset from being dropped. Take out the handset hanger, change the hanger's direction and insert again.

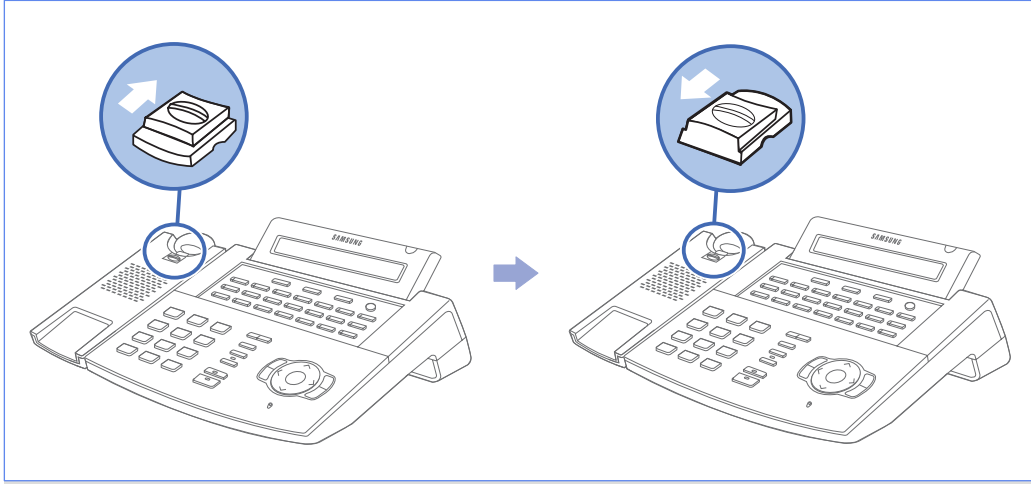

The above figure shows ITP-5121D as a sample. If you purchase ITP-5114D/ITP-5107S, the relevant phone is included.

# THINGS YOU SHOULD KNOW

## Adjusting Volume

The **Volume** [ ▼ ▲ ] button is used for adjusting the volume of the handset, speaker, and ringer.

### Adjusting the Handset Volume

- 1 During a call using the **handset**, press the **[Volume▲]** button to increase the handset volume.

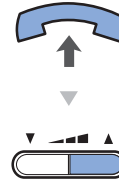

- 2 Press the **[▼Volume]** button to decrease the handset volume.

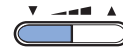

## Adjusting Speaker Volume

- 1 During a call using the **[Speaker]** button, press the **[Volume▲]** button to increase the speaker volume.

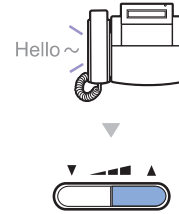

- 2 Press the **[▼Volume]** button to decrease the speaker volume.



## Adjusting Ring Volume

- 1 To increase the ring volume, press the **[Volume▲]** button while the phone is ringing.



- 2 To decrease the ring volume, press the **[▼Volume]** button while the phone is ringing.





## Entering Characters

Using the dial buttons of this phone, you can easily enter/edit, letters, numbers and special characters.

### Special Button Used

To enter letters of the alphabet the following special button is used.

- 'A' Button: Switch to capital/small letters when entering characters.

The 'A' button of the **ITP-5121D/ITP-5114D/ITP-5107S** phone is located on the first button of the bottom row of the programmable buttons below the LCD screen.

#### ITP-5121D

An example for the ITP-5121D is shown.

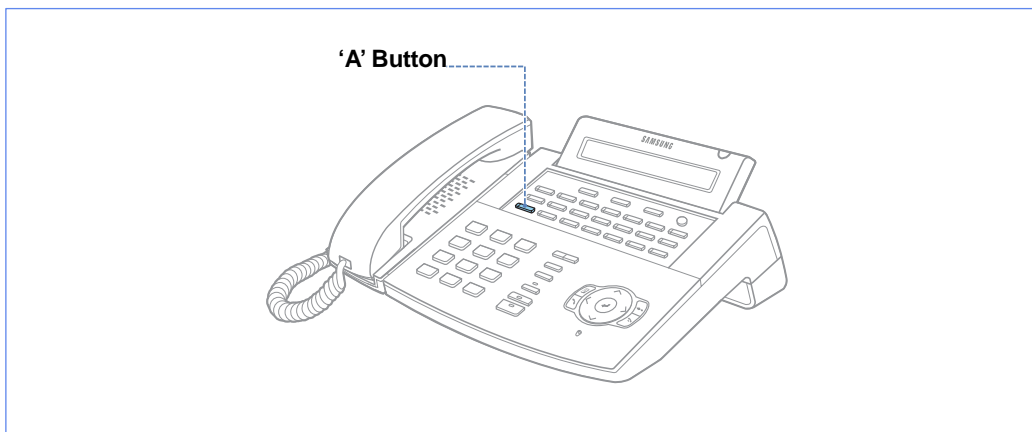

**ITP-5114D**

An example for the ITP-5114D is shown.

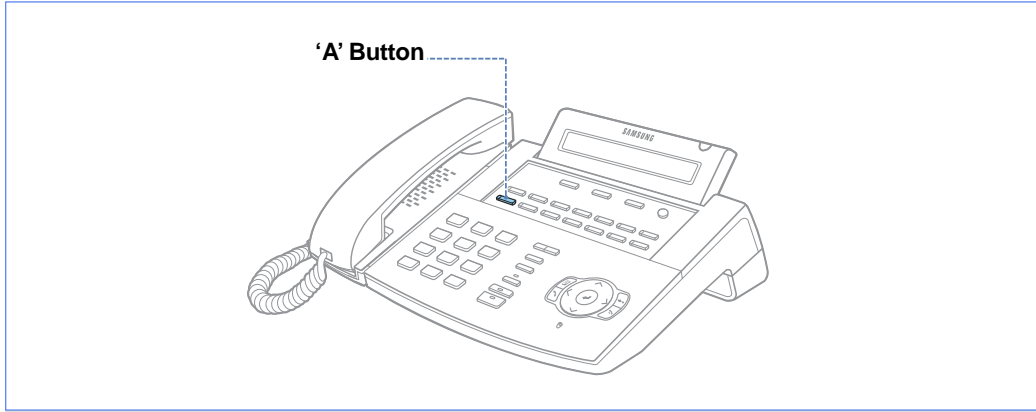
**ITP-5107S**

An example for the ITP-5107S is shown.

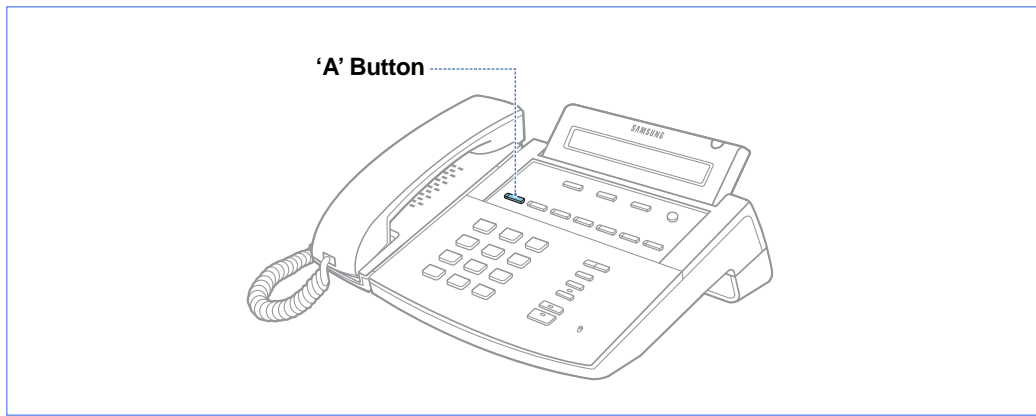

## Entering Characters

Press the **Volume** [ ▼ ▬ ▴ ] button to move the cursor and insert or modify the desired letter. Press the **Volume** [ ▼ ▬ ▴ ] button and move the cursor one space to the right to use the same dial button letters as the previous letter used.

Procedures for entering characters are described below

Enter the characters according to the table below. Press the 'A' button to switch between capital and lower case letters.

Dial frequency Dial button	1	2	3	4	5
0	<	>	.	)	0
1	Space	?	,	!	1
2	A	B	C	@	2
3	D	E	F	#	3
4	G	H	I	\$	4
5	J	K	L	%	5
6	M	N	O	^	6
7	P	Q	R	S	7
8	T	U	V	*	8
9	W	X	Y	Z	9
*	:	=	[	]	*
#	# ? - [ ) 	Space . < ] - ;	& , > @ + "	! % / ^ { →	: \$ = ( } ,

Press the [#] button to enter special characters. Special characters are displayed in the following order.

# ▶ space ▶ & ▶ ! ▶ : ▶ ? ▶ . ▶ , ▶ % ▶ \$ ▶ - ▶ < ▶ > ▶ / ▶ = ▶  
[ ▶ ] ▶ @ ▶ ^ ▶ ( ▶ ) ▶ \_ ▶ + ▶ { ▶ } ▶ | ▶ ; ▶ " ▶ " ▶ → ▶ ' ▶



## Phone Status Indicator

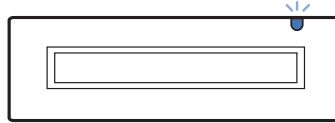

The status indicator turns on or off according to the phone status.



Button	Function
Busy/Off-hook	Steady red.
Extension Ring	Flashing red.
Trunk Ring	Flashing green.
Recalling	Flashing yellow.
Message waiting	Flashing red.
Calling Denied	Fast flashing red within 1 second interval.

## Button LED

The **[Transfer]** button, **[Hold]** button, and **[Speaker]** button have a LED that turns on or off according to the phone status.

Button LED	LED Status	Function
 <b>[Transfer] button</b>	Steady red	When 'Forward All Calls' is set or a Follow me has been set.
 <b>[Hold] button</b>	Flashing red	When the phone is locked for any outgoing Trunk call.
	Steady red	When the entire phone is locked.
 <b>[Speaker] button</b>	Steady red	When the phone is used as a speakerphone.

# BASIC FUNCTIONS



## Making a Call

This function is used when you want to make a call to other stations or to make an external call.

### Calling an Extension Number

This function is used when you want to make a call to other stations.

- 1 Pick up the handset and check for dial tone.



- 2 Dial the extension number or station group number.  
Wait until the other party answers the call.  
If a short signal tone(not a ringing tone) is heard, the receiving extension has set up the Voice Announce or Automatic Answer function.



- 3 Replace the handset or press the **[End]** button to finish the call.



## Calling an Outside number

This function is used when you want to make an external call.

1 Pick up the handset.



2 Press the trunk or trunk group button or dial the trunk group access code (e.g., 0).



3 Dial the telephone number you want to call.



4 Finish your call by replacing the handset or pressing the **[End]** button.



If the hot keypad feature is used, you can make an external call without picking up a handset by dialling the trunk access code.

## Using a Speakerphone

This function is used when you make a call with a speakerphone.

- 1 Press the **[Speaker]** button without lifting the handset.



- 2 Dial the telephone number you want to call.  
Or, press the trunk line call/extension call button registered.



- 3 Once the called party answers the call, get started with speaking to the called party.  
- Lift the handset while speaking to turn off the speaker and continue speaking using the handset.



- 4 Finish the call, by pressing the **[Speaker]** button.



If the LCR(Least Cost Routing) feature is enabled on the OS 7200 system, press the **[LCR]** button or press the LCR access code.

## New Call



This function allows you to disconnect the existing call and make a new call on the same line.

- 1 Press the **[NEW]** button to disconnect your existing call, wait for dial tone and then make a new call on the same line. If this **[NEW]** button does not appear on your phone, press the Soft button corresponding to **[NEW]** on the LCD screen.



## Redial

This function allows you to redial the last external number dialed.

To redial the last telephone number you dialed, press the Send [  ] button for approximately 2 seconds or press [1] [9]. Pressing the Redial [  ] button will give you the option to review up to 10 of your previously dialed external numbers.

1 Press the **[Redial]** button.



2 Use the direction buttons or the **[▼Volume▲]** button to select the required number to redial and press the Soft button corresponding to [Dial].



3 To review details about the previous call prior to dialling it, press the Soft button corresponding to **[NND]**.



4 To Press the **[Redial]** button twice to automatically redial the last number you dialed.



- If the hot keypad feature is turned off, you have to lift up the handset first or press the **Speaker** [  ] button before you begin using the redial feature.
- Redial does not apply to intercom calls.



## Save Number with Redial

You can redial the saved number anytime.

- 1 To save the number you just dialed for later use, press the **[SAVE]** button before hanging up.

[SAVE]



- 2 This saved number can be redialled at any time by pressing the **[SNR]** button or pressing [1]▶[7]. The same external trunk line will be selected for you.

[SNR]



- The saved telephone number will be stored in memory until you save another number.
- Saved Number Redial does not apply to intercom calls.



## Answering a Call

This function is used when you want to answer an intercom call or external call.

### Using a Handset

This function is used when you answer a call with a handset.

1 When the phone rings, pick up the handset.



2 To finish the call replace the handset.

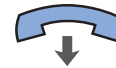

### Using a Speakerphone

This function is used when you answer a call with a speakerphone.

1 Press the **[Send]** button without lifting the handset.



2 Listen to the speaker to hear a voice of the other party and speak through the microphone.

- You can switch from the speakerphone to the handset by lifting the handset.



3 Finish the call, by pressing the **[Speaker]** button.



Press the **Volume** [ ▼ ▲ ] button while the phone is ringing to adjust the ringer volume.

## Call Pickup

This function is used when you pickup a call that is ringing at another station. If a call rings on another station and you know the station number, you can answer the call on your phone.

- 1** A call is ringing on another station.

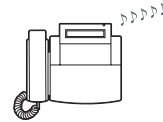

- 2** Pick up the handset and listen for the dial tone.



- 3** Press **[6]** ► **[5]**.



- 4** Dial the station number that is ringing.



## Features Used During a Call

These convenient functions may be used during a call.

### Hold an Intercom Call

You can put the other party on hold if another intercom call arrives or you wish to use both hands for another task and resume the call later.

1

Press **[Hold]** button and replace the handset to put the current call on hold.

- The intercom call is placed into exclusive hold and cannot be retrieved at another station.

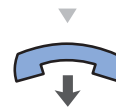

2

To call again, pick up the handset, and press the **[Hold]** button.





## Hold an Outside Call

You can put the other party on hold if another call arrives or you wish to use both hands for another task and resume the call later.

- 1 While you are engaged in a conversation, press the **[Hold]** button. Then the call on hold will flash green on your phone and the call will flash red on other stations.



- 2 To resume your conversation with the held call, press the button with the flashing green LED.



## Mute

During a call you can mute the handset transmitter or microphone while still listening to the other party.

- 1 Press the **[MUTE]** button or the soft button corresponding to **[MUTE]** on the LCD screen. Then, the **[MUTE]** button will turn on red.



- 2 Press the blinking **[MUTE]** button to clear the mute function.



## Transferring a Call

While on an external call you can transfer the call to another internal or outside party. You can transfer your call to another extension or return to the outside party.

- 1** While on a call, press the **[Transfer]** button.  
Your call is automatically put on transfer hold.





- 2** Dial an extension or group number. Or, press the [DSS] button or station group button.  
Your call will be automatically put on transfer hold.

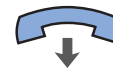

- 3** For blind transfer, hang up when you hear ringing. Or, wait for the called party to answer and advise him/her of the call. Then hang up.



- When you are transferring a call to a station programmed for Voice Announce or Auto Answer, the transferred call will always ring.
- After the internal party answers, you may alternate back and forth between the parties by pressing the Transfer [  ] button.
- You cannot transfer an Intercom call by pressing the [DSS] button for the station required. You must press the Transfer [  ] button first and then press the [DSS] button or dial the destination extension number.



## Conference Calls

You can make a conference call of up to 5 parties including yourself. The OS 7200 system also allows each station to pre assign up to 5 conference groups so you can set up a conference call by pressing a single [Group Conference] programmable button. Refer to your System Administrator to confirm that this option is available to you.

- 1** Press the **[Conference]** button while engaged in a conversation. You will hear conference tone.



- 2** Make another call, either intercom or external. Press the **[Conference]** button and you will hear conference Tone. ,



- 3** Make another call to add additional parties or press the **[Conference]** button to join all parties into the conference. Then, Repeat the last step, until all other parties required are connected.



- 4** To drop a person from your conference call, press the **[Conference]** button and dial the extension or trunk number that is to be dropped.



Press the **[Conference]** button again to re-establish the conference.



When attempting to add another person to the conference and you are not able to reach the desired person, simply press the **Conference [ ]** button again.

# APPLICATION MENU

## Navigation Buttons

The ITP-5121D and ITP-5114D IP phones have navigation buttons for convenient use of the IP phone functions. This chapter introduces the functions available using the navigation buttons and procedures for using the various applications.

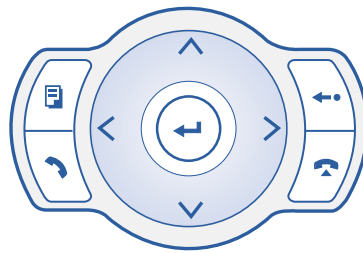

### Menu Button ( )

- 1** The main menu is displayed when the **Menu** [  ] button is pressed in the idle state, You can select from the presented options.



1. OUTGOING LOGS  
2. INCOMING LOGS  
3. SPD NO. SEARCH  
4. DIRECTORY DIAL  
5. FORWARD ASSIGN  
6. ALARM ASSIGN

- 2** This menu is displayed when the **Menu** [  ] button is pressed when dialling mode or when transferring calls.

This allows you select to select and perform a function.

1. OUTGOING LOGS  
2. INCOMING LOGS  
3. SPD NO. SEARCH  
4. DIRECTORY DIAL







Calls will be maintained even if the **Menu** [  ] button is pressed while you are talking. If you press the **End** [  ] button or the other buttons except the Navigation buttons in menu mode, you will automatically exit from the menu mode and return to the idle screen.





## Send Button ( )



If you press the **Send** [  ] button while the [OUTGOING LOGS], [INCOMING LOGS], [SPD NO. SEARCH], or [DIRECTORY DIAL] function is selected, the corresponding number will be dialed.

- If you press the **Send** [  ] button in idle mode, you enter the [OUTGOING LOGS] menu.
- If you press the **Send** [  ] button in dial mode, you enter the [OUTGOING LOGS] menu regardless of the numbers previously dialed.
- If you press the **Send** [  ] button while a call is arriving (ringing status), you will answer the call on the speakerphone.

## End Button ( )

This button is used to disconnect calls or to exit the phone menus and return to the idle display.

## Cancel button ( )

The **Cancel** [  ] button is used in menu mode to move to the previous level. If the **Cancel** [  ] button is pressed when you first enter menu mode, the menu mode is exited.

The **Cancel** [  ] button is also used to delete the characters previously entered when entering numbers or characters.

## Enter button ( )

This button is used in the menu mode to select or save the item that the cursor is indicating. This button may also be used for the [NND(Name Number Display)] button when receiving calls.

- The [NND] button displays 'caller number', 'caller name', and 'received time' when you press the button, if the caller information is available.

## Direction button

These buttons are used when editing menu entries, or when moving between menu items.

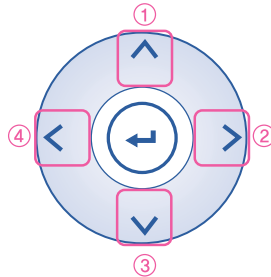

① [ ^ ] button is used

Used for moving to the previous menu.

② [ > ] button is used

In cases where the phone number is long, this button is used for displaying the rear part of the number which is not displayed on the LCD screen.

③ [ v ] button is used

Used for moving to the next menu.

④ [ < ] button is used



In cases where the phone number is long, this button is used for displaying the front part of the number which is not displayed on the LCD screen.





## Entering Application Menus

When the phone is in the standby mode, press the **Menu** [  ] button. The main application menu will appear on the LCD screen.

1. OUTGOING LOGS
2. INCOMING LOGS
3. SPD NO. SEARCH
4. DIRECTORY DIAL
5. FORWARD ASSIGN
6. ALARM ASSIGN

### How to Select Menu

To select a menu items, you can use the navigation direction buttons, **Volume** [   ] button or the dial buttons.

- Use the [^]/[v] direction buttons or the **Volume** [   ] button and move to the preferred menu.
- You can select the menu directly by pressing the dial button corresponding to the menu number.
- Press the **Enter** [  ] button to select the menu underlined by the cursor to expose sub-menus.
- Press the **End** [  ] button to exit the menu and return to the idle screen.
- When buttons other than the navigation buttons are pressed, the menu mode will end.





When your station is called while in menu mode, your phone will appear as busy to the calling party.

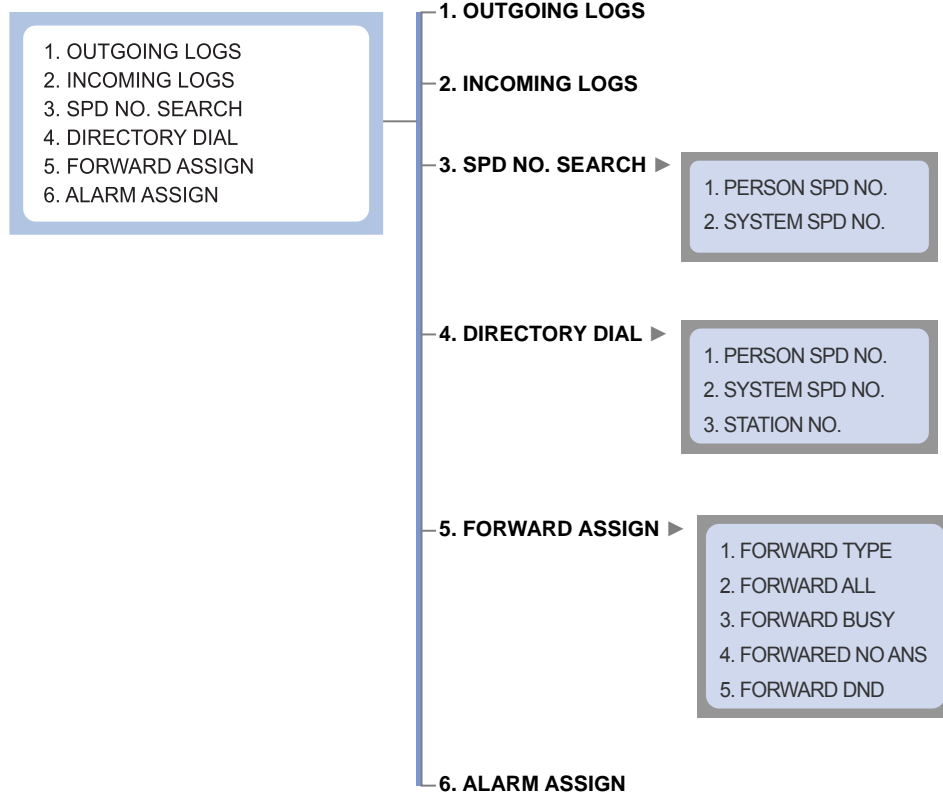

## Application Menus

The main application menu will appear on the LCD screen, by pressing the **Menu** [  ] button.



- To use the '3. SPD NO. SEARCH' and '5. FORWARD ASSIGN' menu function you should consult your System Administrator.
- If the **Transfer** [  ] button is pressed, the available menus are '1. OUTGOING LOGS', '2. INCOMING LOGS', '3. SPD NO. SEARCH' and '4. DIRECTORY DIAL'.

# TROUBLESHOOTING

Possible problems and troubleshooting steps for your phone are described below.  
Check the troubleshooting steps before contacting your Authorized Samsung Reseller.

**The phone does not boot when the power is connected.**

- ▶ - Check to confirm that the data network cable is connected to the LAN socket on the phone properly.
- Check to confirm that the connected power adaptor is the one supplied with the Phone.
- Disconnect the power adaptor from the phone, and connect it again after about 10 seconds. (Refer to 'Connecting Lines to the Phone' section of 'Preparation' in this guide.)

**The phone does function after booting.**

- ▶ - If the screen of the phone displays 'IP conflict', you should consult your Network Administrator. This indicates another network device(e.g. PC) is using the same IP address as your phone.
- If the screen of the phone displays 'ID conflict', you should consult your System Administrator. This indicates the user ID for your phone is already in use by another phone user.

**Dial tone is not heard when you lift the handset or press the Speaker [🔊] button.**

- ▶ - Check that the data network cable and the data cable to your PC are connected correctly to the LAN and PC sockets respectively.
- Check that the network environment is setup correctly in the phone.(You should consult your System Administrator.)

**Nothing appears on the LCD screen while the phone is being used.**

- ▶ Check that the data network cable is correctly connected to the LAN socket on the phone. (Refer to 'Connecting Lines to the Phone' section of 'Preparation' in this guide.)



**The Phone does not ring and volume is too low.**

- ▶ Press the Volume [ ▾ 🔊 ▸ ] button to adjust the volume.(Refer to 'Volume Adjustment' section of the 'Things You Should Know' section in this guide.)

**Conversation quality is reduced due to noise and echo.**

- ▶ If you are using the speakerphone, lift the handset and try speaking.

**Excessive echo is emitted during a page announcement or with Auto Answer set.**

- ▶ If phones are too close to each other, sound from one speaker might echo during a page or on auto answer call. Maintain a reasonable distance(about 1 m) between phones.

**An alarm does not ring at the programmed time.**

- ▶ - Check the current time is set on the Phone correctly. If the current time setting needs to be changed, contact your System Administrator.
- Check if an alarm is set.(You should consult your System Administrator.)

**Caller IDs are not displayed on the LCD screen.**

- ▶ - Confirm with your System Administrator that the caller ID service is available from your telephone company.
- If the caller blocks the sending of their caller ID, the caller ID will not be displayed.
- If the caller makes a call from an area where the caller ID cannot be provided (e.g., international calls), the caller ID will not be displayed.
- ▶ - If the caller makes a call from a public phone, the caller ID will not be displayed.
- If the caller ID received from the Telephone Company is corrupt, the caller ID will not be displayed.
- If the Telephone Company does not send a caller ID, the caller ID will not be displayed.

# ANNEX

## Product Specifications

The specifications and features of the ITP-5121D/ITP-5114D/ITP-5107S IP phone are as follows.

Items	Specification		
<b>Model</b>	ITP-5121D	ITP-5114D	ITP-5107S
<b>Size(mm)</b>	235(width) × 206(length) × 119(height)		235(width) × 206(length) × 100(height)
<b>Weight(kg)</b>	1.0		
<b>Operating Temperature(°C)</b>	0~45		
<b>Operating Humidity(%)</b>	10~90		
<b>Input Power</b>	AC 100v ~ 250v/50~60 Hz		
<b>Output Power</b>	DC 5 V/3 A, 36~57 V/400 mA		
<b>Number of the [Programmable] buttons</b>	21	14	7
<b>Navigation Button</b>	○		×
<b>LCD</b>	2 Line LCD (24 characters long: English)		



A large rectangular area with rounded corners, containing numerous horizontal dashed lines for writing or drawing.



## Free Manuals Download Website

<http://myh66.com>

<http://usermanuals.us>

<http://www.somanuals.com>

<http://www.4manuals.cc>

<http://www.manual-lib.com>

<http://www.404manual.com>

<http://www.luxmanual.com>

<http://aubethermostatmanual.com>

Golf course search by state

<http://golfingnear.com>

Email search by domain

<http://emailbydomain.com>

Auto manuals search

<http://auto.somanuals.com>

TV manuals search

<http://tv.somanuals.com>